

IND256x

Weighing Terminal



IND256x Weighing Terminal

METTLER TOLEDO Service

Essential Services for Dependable Performance of Your IND256x Weighing Terminal

Congratulations on choosing the quality and precision of METTLER TOLEDO. Proper use of your new equipment according to this Manual and regular calibration and maintenance by our factory-trained service team ensures dependable and accurate operation, protecting your investment. Contact us about a service agreement tailored to your needs and budget. Further information is available at www.mt.com/service.

There are several important ways to ensure you maximize the performance of your investment:

1. **Register your product:** We invite you to register your product at www.mt.com/productregistration so we can contact you about enhancements, updates and important notifications concerning your product.
2. **Contact METTLER TOLEDO for service:** The value of a measurement is proportional to its accuracy – an out of specification scale can diminish quality, reduce profits and increase liability. Timely service from METTLER TOLEDO will ensure accuracy and optimize uptime and equipment life.
 - a. **Installation, Configuration, Integration and Training:** Our service representatives are factory-trained, weighing equipment experts. We make certain that your weighing equipment is ready for production in a cost effective and timely fashion and that personnel are trained for success.
 - b. **Initial Calibration Documentation:** The installation environment and application requirements are unique for every industrial scale so performance must be tested and certified. Our calibration services and certificates document accuracy to ensure production quality and provide a quality system record of performance.
 - c. **Periodic Calibration Maintenance:** A Calibration Service Agreement provides on-going confidence in your weighing process and documentation of compliance with requirements. We offer a variety of service plans that are scheduled to meet your needs and designed to fit your budget.
 - d. **GWP® Verification:** A risk-based approach for managing weighing equipment allows for control and improvement of the entire measuring process, which ensures reproducible product quality and minimizes process costs. GWP (Good Weighing Practice), the science-based standard for efficient life-cycle management of weighing equipment, gives clear answers about how to specify, calibrate and ensure accuracy of weighing equipment, independent of make or brand.

© METTLER TOLEDO 2022

No part of this manual may be reproduced or transmitted in any form or by any means, electronic or mechanical, including photocopying and recording, for any purpose without the express written permission of METTLER TOLEDO.

U.S. Government Restricted Rights: This documentation is furnished with Restricted Rights.

Copyright 2022 METTLER TOLEDO. This documentation contains proprietary information of METTLER TOLEDO. It may not be copied in whole or in part without the express written consent of METTLER TOLEDO.

COPYRIGHT

METTLER TOLEDO® is a registered trademark of Mettler-Toledo, LLC. All other brand or product names are trademarks or registered trademarks of their respective companies.

METTLER TOLEDO RESERVES THE RIGHT TO MAKE REFINEMENTS OR CHANGES WITHOUT NOTICE.

FCC Notice

This device complies with Part 15 of the FCC Rules and the Radio Interference Requirements of the Canadian Department of Communications. Operation is subject to the following conditions: (1) this device may not cause harmful interference, and (2) this device must accept any interference received, including interference that may cause undesired operation.

This equipment has been tested and found to comply with the limits for a Class B digital device, pursuant to Part 15 of the FCC Rules. These limits are designed to provide reasonable protection against harmful interference in a residential installation. This equipment generates, uses and can radiate radio frequency energy and, if not installed and used in accordance with the instructions, may cause harmful interference to radio communications. However, there is no guarantee that interference will not occur in a particular installation. If this equipment does cause harmful interference to radio or television reception, which can be determined by turning the equipment off and on, the user is encouraged to try to correct the interference by one or more of the following measures:

- Reorient or relocate the receiving antenna.
- Increase the separation between the equipment and receiver.
- Connect the equipment into an outlet on a circuit different from that to which the receiver is connected.
- Consult the dealer or an experienced radio/TV technician for help.

The manufacturer is not responsible for any radio or TV interference caused by unauthorized modifications to this equipment. Such modifications could void the user's authority to operate the equipment.

- Supplier Declaration of Conformity (SDoC) is available at <http://glo.mt.com/global/en/home/search/compliance.html/compliance/>.

FCC RF Safety Statement

To satisfy FCC RF exposure requirements for mobile and base station transmission devices, a separation distance of 20 cm or more should be maintained between the antenna of this device and persons during operation. To ensure compliance, operation at closer than this distance is not recommended. The antenna(s) used for this transmitter must not be co-located or operating in conjunction with any other antenna or transmitter.

The device has been evaluated to meet general RF exposure requirement.

IC Notice

This device contains license-exempt transmitter(s)/receiver(s) that comply with Innovation, Science and Economic Development Canada's license-exempt RSS(s). Operation is subject to the following two conditions:

- (1) This device may not cause interference.
- (2) This device must accept any interference, including interference that may cause undesired operation of the device.

















L'émetteur/récepteur exempt de licence contenu dans la présent appareil est conforme aux CNR d'Innovation, Sciences et Développement économique Canada applicables aux appareils radio exempts de licence. L'exploitation est autorisée aux deux conditions suivantes :

















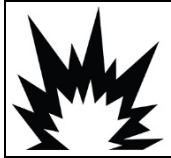

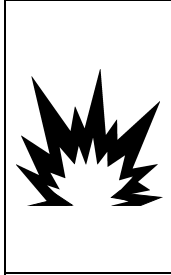
- (1) L'appareil ne doit pas produire de brouillage ;
- (2) L'appareil doit accepter tout brouillage radioélectrique subi, même si le brouillage est susceptible d'en compromettre le fonctionnement.





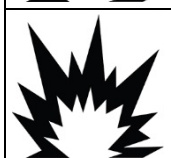

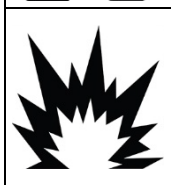











Avis : Pour répondre à la IC d'exposition pour les besoins de base et mobiles dispositifs de transmission de la station, sur une distance de séparation de 20 cm ou plus doit être maintenue entre l'antenne de cet appareil et les personnes en cours de fonctionnement. Pour assurer le respect, l'exploitation de plus près à cette distance n'est pas recommandée. L'antenne(s) utilisé pour cet émetteur ne doit pas être localisés ou fonctionner conjointement avec une autre antenne ou transmetteur.

Warnings and Cautions

- READ this manual BEFORE operating or servicing this equipment and FOLLOW these instructions carefully.
- SAVE this manual for future reference.

	<p style="text-align: center;"> WARNING</p> <p>DO NOT INSTALL OR PERFORM ANY SERVICE ON THIS EQUIPMENT BEFORE THE AREA IN WHICH THE IND256X IS LOCATED HAS BEEN SECURED AS NON-HAZARDOUS BY PERSONNEL AUTHORIZED TO DO SO BY THE RESPONSIBLE PERSON AT THE CUSTOMER'S SITE.</p>
	<p style="text-align: center;"> CAUTION</p> <p>CONFIRM COMPLIANCE WITH APPLICABLE NATIONAL AND LOCAL WIFI REGULATIONS BEFORE INSTALLING AND COMMISSIONING IND256X TERMINAL CONFIGURED WITH WIFI MODULE. METTLER TOLEDO ACCEPTS NO RESPONSIBILITY FOR TERMINAL INSTALLATION IN COUNTRIES WHERE WIFI REGULATIONS ARE NOT FULFILLED. PRODUCT WIFI APPROVALS CAN BE FOUND AT HTTP://GLO.MT.COM/GLOBAL/EN/HOME/SEARCH/COMPLIANCE.HTML/COMPLIANCE/.</p>
	<p style="text-align: center;"> WARNING</p> <p>IF THE IND256x KEYBOARD, DISPLAY LENS OR ENCLOSURE IS DAMAGED, THE DEFECTIVE COMPONENT MUST BE REPLACED IMMEDIATELY. REMOVE POWER IMMEDIATELY AND DO NOT REAPPLY POWER UNTIL THE DISPLAY LENS, KEYBOARD OR ENCLOSURE HAS BEEN REPAIRED OR REPLACED BY QUALIFIED SERVICE PERSONNEL. FAILURE TO DO SO COULD RESULT IN BODILY HARM AND/OR PROPERTY DAMAGE.</p>
	<p style="text-align: center;"> CAUTION</p> <p>USE ONLY METTLER TOLEDO SPARE PARTS WHEN REPLACING THE WIFI MODULE. METTLER TOLEDO ACCEPTS NO RESPONSIBILITY FOR SAFETY OR COMPLIANCE RISKS CAUSED BY USE OF INCORRECT COMPONENTS.</p>
	<p style="text-align: center;"> WARNING</p> <p>AVOID ELECTROSTATIC CHARGING DURING OPERATION AND MAINTENANCE.</p>
	<p style="text-align: center;"> WARNING</p> <p>OPERATION IS ONLY PERMITTED WHEN OPERATIONAL AND PROCESS-RELATED ELECTROSTATIC CHARGES ARE NOT PRESENT.</p>
	<p style="text-align: center;"> WARNING</p> <p>USE THE WEIGHING TERMINAL ONLY WHEN ELECTROSTATIC PROCESSES LEADING TO PROPAGATION BRUSH DISCHARGE IS IMPOSSIBLE.</p>
	<p style="text-align: center;"> WARNING</p> <p>KEEP THE TERMINAL AWAY FROM PROCESSES THAT GENERATE HIGH CHARGING POTENTIAL SUCH AS ELECTROSTATIC COATING, RAPID TRANSFER OF NON-CONDUCTIVE MATERIALS, RAPID AIR JETS, AND HIGH PRESSURE AEROSOLS.</p>

	<p style="text-align: center;"> WARNING</p> <p>DO NOT USE DRY CLOTH TO CLEAN THE WEIGHING TERMINAL. ALWAYS USE A DAMP CLOTH TO CLEAN THE TERMINAL GENTLY.</p>
	<p style="text-align: center;"> WARNING</p> <p>WEAR SUITABLE CLOTHING. AVOID NYLON, POLYESTER OR OTHER SYNTHETIC MATERIALS THAT GENERATE AND HOLD CHARGE. USE CONDUCTIVE FOOTWEAR AND FLOORING.</p>
	<p style="text-align: center;"> WARNING</p> <p>AVOID PLASTIC COVERS OVER THE TERMINAL.</p>
	<p style="text-align: center;"> WARNING</p> <p>ENSURE PROPER EQUIPOTENTIAL GROUNDING OF THE TERMINAL, MOUNTING ACCESSORIES, AND THE SCALE BASE.</p>
	<p style="text-align: center;"> WARNING</p> <p>TERMINAL MUST BE PROTECTED FROM UV LIGHT.</p>
	<p style="text-align: center;"> WARNING</p> <p>FOR THE DC VERSION OF THE IND256X TERMINAL, THERE IS NO GALVANIC SEPARATION BETWEEN NON-INTRINSICALLY SAFE SUPPLY CIRCUIT AND INTRINSICALLY SAFE OUTPUT CIRCUITS. THE NON-INTRINSICALLY SAFE CIRCUIT MUST BE SAFELY CONNECTED TO EARTH. AND POTENTIAL EQUALIZATION MUST EXIST ALONG INTRINSICALLY SAFE CIRCUITS. ALTERNATIVELY, THE NON-INTRINSICALLY SAFE SUPPLY CIRCUIT (SELV) MUST BE SAFELY SEPARATED FROM EARTH.</p>
	<p style="text-align: center;"> WARNING</p> <p>THE EXTERNAL CUSTOMER-PROVIDED DC POWER SUPPLY MUST HAVE A CATEGORY II MAXIMUM OVER-VOLTAGE, ACCORDING TO IEC 60664-1.</p>
	<p style="text-align: center;"> WARNING</p> <p>SUFFICIENT STRAIN RELIEF MUST BE ENSURED TO PREVENT TENSILE FORCES ON THE CABLE GLANDS.</p>
	<p style="text-align: center;"> WARNING</p> <p>THE CABLE GLANDS MUST BE PROTECTED AGAINST DAMAGE FROM IMPACT.</p>
	<p style="text-align: center;"> WARNING</p> <p>THE TERMINAL ASSEMBLED WITH WIFI ANTENNA SHALL BE INSTALLED IN A POSITION IN SUCH A WAY THAT THE RISK FOR MECHANICAL DAMAGE IS LOW. REPLACE THE WIFI ANTENNA IMMEDIATELY IF DAMAGED.</p>

	<p style="text-align: center;"> WARNING</p> <p>IND256X TERMINALS FACTORY-CONFIGURED WITH WIFI ARE APPROVED FOR USE IN ZONE 1 EQUIPMENT GROUP IIB CLASSIFIED AREAS. IND256X TERMINALS FACTORY-CONFIGURED WITH WIFI MUST NOT BE USED IN EQUIPMENT GROUP IIC CLASSIFIED AREA. USING THE IND256X TERMINAL FACTORY-CONFIGURED WITH WIFI IN A CLASSIFIED AREA FOR WHICH IT IS NOT APPROVED COULD RESULT IN BODILY HARM AND/OR PROPERTY DAMAGE.</p>
	<p style="text-align: center;"> WARNING</p> <p>THE WIFI BOARD (30458681) AND WIFI ANTENNA (30458682) CANNOT BE RETROFITTED TO AN IND256X WHICH WAS NOT FACTORY-CONFIGURED WITH WIFI CAPABILITY.</p>
	<p style="text-align: center;"> WARNING</p> <p>THE EXTERNAL CUSTOMER-PROVIDED DC POWER SUPPLY MUST HAVE A MAXIMUM OVER-VOLTAGE CATEGORY II ACCORDING TO IEC 60664-1.</p>
	<p style="text-align: center;"> WARNING</p> <p>DO NOT OPEN THE TERMINAL WHEN THE ATMOSPHERE IS EXPLOSIVE DUE TO DUST. TO PREVENT IGNITION OF HAZARDOUS ATMOSPHERES, DISCONNECT THE IND256X FROM ITS POWER SOURCE BEFORE OPENING THE ENCLOSURE. KEEP COVER TIGHTLY CLOSED WHILE THE CIRCUIT IS ENERGIZED. DO NOT OPEN WHEN AN EXPLOSIVE DUST ATMOSPHERE IS PRESENT.</p>
	<p style="text-align: center;"> WARNING</p> <p>ALL EQUIPMENT MUST BE INSTALLED PER MANUFACTURER'S DOCUMENT DRAWING NUMBER 30282892B AND APPLICABLE LOCAL CODES.</p>
	<p style="text-align: center;"> WARNING</p> <p>ONLY THE COMPONENTS SPECIFIED IN THE INSTALLATION MANUAL INCLUDED ON THE DOCUMENTATION CD-ROM 30512916 CAN BE USED IN THIS DEVICE. ALL EQUIPMENT MUST BE INSTALLED IN ACCORDANCE WITH THE INSTALLATION INSTRUCTIONS. INCORRECT OR SUBSTITUTE COMPONENTS AND/OR DEVIATION FROM THESE INSTRUCTIONS CAN IMPAIR THE INSTRINSIC SAFETY OF THE TERMINAL AND COULD RESULT IN BODILY INJURY AND/OR PROPERTY DAMAGE.</p>
	<p style="text-align: center;"> WARNING</p> <p>FOR CONTINUED PROTECTION AGAINST SHOCK HAZARD, CONNECT TO PROPERLY GROUNDED POWER SOURCE ONLY. DO NOT REMOVE THE GROUNDING CONNECTION.</p>
	<p style="text-align: center;"> WARNING</p> <p>WHEN THIS EQUIPMENT IS INCLUDED AS A COMPONENT PART OF A SYSTEM, THE RESULTING DESIGN MUST BE REVIEWED BY QUALIFIED PERSONNEL WHO ARE FAMILIAR WITH THE CONSTRUCTION AND OPERATION OF ALL COMPONENTS IN THE SYSTEM AND THE POTENTIAL HAZARDS INVOLVED. FAILURE TO OBSERVE THIS PRECAUTION COULD RESULT IN BODILY HARM AND/OR PROPERTY DAMAGE.</p>
	<p style="text-align: center;"> WARNING</p> <p>ONLY PERMIT QUALIFIED PERSONNEL TO SERVICE THE IND256X. EXERCISE CARE WHEN MAKING CHECKS, TESTS AND ADJUSTMENTS THAT MUST BE MADE WITH POWER ON. FAILING TO OBSERVE THESE PRECAUTIONS CAN RESULT IN BODILY HARM AND/OR PROPERTY DAMAGE.</p>

	<p style="text-align: center;"> WARNING</p> <p>BEFORE CONNECTING/DISCONNECTING ANY INTERNAL ELECTRONIC COMPONENTS OR INTERCONNECTING WIRING BETWEEN ELECTRONIC EQUIPMENT ALWAYS REMOVE POWER AND WAIT AT LEAST THIRTY (30) SECONDS BEFORE ANY CONNECTIONS OR DISCONNECTIONS ARE MADE. FAILURE TO OBSERVE THESE PRECAUTIONS COULD RESULT IN DAMAGE TO OR DESTRUCTION OF THE EQUIPMENT AND/OR BODILY HARM.</p>
	<p style="text-align: center;"><i>NOTICE</i></p> <p>OBSERVE PRECAUTIONS FOR HANDLING ELECTROSTATIC SENSITIVE DEVICES.</p>

Disposal of Electrical and Electronic Equipment

In conformance with the European Directive 2012/19/EC on Waste Electrical and Electronic Equipment (WEEE) this device may not be disposed of in domestic waste. This also applies to countries outside the EU, per their specific requirements.



Please dispose of this product in accordance with local regulations at the collecting point specified for electrical and electronic equipment.

If you have any questions, please contact the responsible authority or the distributor from which you purchased this device.

Should this device be passed on to other parties (for private or professional use), the content of this regulation must also be related.

Thank you for your contribution to environmental protection.

Contents

1	Introduction	1-1
1.1.	IND256x Overview	1-1
1.2.	Product Specification	1-2
1.3.	Testing Standards	1-5
1.4.	Warnings and Precautions	1-6
1.5.	Inspection and Contents Checklist	1-7
1.6.	Configuration.....	1-8
1.7.	Equipotential Bonding (EB)	1-10
1.8.	Operating Environment	1-10
1.9.	Dimensions.....	1-11
1.10.	Main Board	1-13
1.11.	Communication Option Boards	1-13
2	Operation	2-1
2.1.	Overview.....	2-1
2.2.	Display and Keyboard	2-2
2.3.	Data Input.....	2-6
2.4.	Main Display	2-7
3	Configuration	3-1
3.1.	Enter Setup.....	3-1
3.2.	Exit Setup.....	3-2
3.3.	Setup Menu	3-2
3.4.	Configuration Overview	3-3
3.5.	Scale.....	3-4
3.6.	Application	3-24
3.7.	Terminal	3-38
3.8.	Communication	3-44
3.9.	Maintenance	3-55
4	Service and Maintenance	4-1
4.1.	Terminal Cleaning and Maintenance.....	4-1
4.2.	Service	4-2
4.3.	Error Messages.....	4-2
4.4.	System Information	4-4
4.5.	Firmware Upgrade.....	4-5

4.6.	Backup and Restore Using InSite™	4-5
4.7.	Troubleshooting	4-5
4.8.	Master Reset	4-10
A	Parameter Values	A-1
B	Communication	B-1
B.1.	Demand Output Mode.....	B-1
B.2.	Continuous Output Mode.....	B-1
B.3.	CTPZ	B-3
B.4.	Standard Interface Command Set (SICS) Protocol.....	B-4
B.5.	Reports.....	B-13
B.6.	Label Design and Printing	B-15
C	GEO Codes	C-1
C.1.	Original Site Calibration	C-1
C.2.	New Site GEO Code Adjustment	C-1

1 Introduction

1.1. IND256x Overview

The IND256x reflects the latest weighing technology from METTLER TOLEDO. The IND256x has passed third-party certification for weighing in hazardous areas, and can be directly used in Zone 1/ 21, Division 1 locations.

A high-performance single-range or multi-range weighing terminal, the IND256x uses analog load cells to achieve reliable weighing at low cost, from grams to tons. It is easily integrated in an existing weighing system.

By connecting the appropriate safety barrier or isolated barrier, the IND256x can provide various intrinsically safe communication interfaces to communicate with PCs and printers in the non-hazardous area. These features permit IND256x to support a majority of weighing applications in most industrial fields, including:

- Pharmacy
- Powder processes
- Special chemicals
- Petrochemicals
- Agriculture
- Paints and inks
- Fine chemical engineering

1.1.1. IND256x Terminal Version

The IND256x is available with three different power supply choices:

- AC power input, using external alternating voltage (187-250 V 50/60 Hz)
- DC power input, using external direct voltage (DC 18-30 V)
- Intrinsically safe power input, using an external IND256x Ex NiMH battery pack or APS500/501

Each of these versions has received ATEX and IECEx approvals for use in Zone 1 and Zone 21 classified areas. Only the intrinsically safe input power version is approved by cFMus.

1.1.2. IND256x Product Features

- Basic weighing in hazardous areas, including zero, tare and print functions
- Harsh environment desk, column- or wall-mounted enclosure
- Connects to a single analog weighing platform
- 240 x 96 pixel white backlit LCD, 25mm high digits
- Real-time clock (power-down save)

- Includes one intrinsically safe serial port (COM1) for asynchronous two-way communication and print output
- Support for the following internal option boards:
 - Intrinsically safe 4-20 mA analog output
 - WiFi communication module with antenna (only in IND256x terminals factory-configured with WiFi module)
 - Active current loop – for connection to an ACM200 communication module located in the non-hazardous area, or to connect second IND256x terminal configured with passive current loop option
 - Passive current loop (used as the second display to connect another terminal with an active current loop)
- Supports three customized ID inputs
- Target table supports 25 pre-set targets for Checkweighing
- Tare table supports 20 pre-set tare values
- Supports g, kg, t, ton, lb and oz
- Saves 60,000 transaction data items
- Supports accumulation and accumulative total
- Permits the customization of five different print templates
- Supports weight-free calibration (CalFREE™)

1.2. Product Specification

Table 1-1 shows the IND256x specifications.

Table 1-1: IND256x Specifications

Item	Specification
Enclosure	304 stainless steel, can be wall- or pole-mounted
Dimensions (h × w × d)	173 mm × 230 mm × 127 mm (6.8 in. × 9.1 in. × 5.0 in.)
Transport weight	3.5 kg (8 lb)
Protection grade	IP66
Storage environment	Storage temperature range: –20°C to 60° C (–4° to 140°F) Relative humidity: 10% to 95%, non-condensing
Service environment	Operating temperature range: –10°C to 40° C (14° to 104°F) Relative humidity: 10% to 95%, non-condensing

Item	Specification
Hazardous area	IND256x is approved for use in Zone 1/Zone 21 hazardous areas
Power supply	AC power (187-253V 50/60Hz) (ATEX and IECEx version) DC power (DC 18-30 V) (ATEX and IECEx version) APS500/501 or external IND256x NiMH Ex battery pack (ATEX, IECEx and cFMus version)
Display	240 x 96 pixel white backlit LCD, 25mm high digits Display update rate: 10 Hz
Weight display	Maximum 100,000 divisions
Weighing platform type	Analog load cell
Sensor quantity	Maximum of four 350-ohm load cells (minimum 87 ohm), 2 mv/V or 3 mv/V
Weighing platform quantity	Supports one weighing platform
Refresh rate	>366 Hz
Sensor excitation voltage	4.5 VDC
Minimum sensitivity	0.6 μ V/e
Keyboard	26 keys; 1.5mm thick membrane keyboard
Communication	<p>Standard interface: The mainboard is provided with an intrinsically safe RS232 communication interface</p> <p>Interface options: Intrinsically safe 4-20 mA analog output module, with 16-bit D/A conversion and 25 Hz update rate to PLC or WiFi communication module (only in IND256x terminals factory-configured with WiFi module); or Intrinsically safe active current loop or Intrinsically safe passive current loop</p> <p>Communication Protocols: Serial port input: ASCII commands - CTPZ (Clear, Tare, Print, Zero), SICS commands (supports SICS level 0 and level 1) Serial port output: Toledo continuous output, command print output (5 configurable templates), SICS command and report print</p>
Metrological Approval	Europe: OIML R76; Class III, 6000e; TC10878 Global: OIML R76; Class III, 6000e; R76-2006-A-NL1-18.27 US: Class III/IIIL, nmax=10,000; CC No.: 18-099 Canada: Class III/IIHD, nmax=10,000; AM-6115

Item	Specification
Approvals, ATEX/IECEX	Non Wi-Fi version AC and DC version: II 2G Ex eb ib [ib] mb IIC T4 Gb II 2D Ex tb [ib] IIIC T60°C Db -10°C ≤ Ta ≤ +40°C Battery version: II 2G Ex ib IIC T4 Gb II 2D Ex tb [ib] IIIC T60°C Db -10°C ≤ Ta ≤ +40°C
	Factory-configured WiFi version AC and DC version: II 2G Ex eb ib [ib] mb IIB T4 Gb II 2D Ex tb [ib] IIIC T60°C Db -10°C ≤ Ta ≤ +40°C Battery version: II 2G Ex ib IIB T4 Gb II 2D Ex tb [ib] IIIC T60°C Db -10°C ≤ Ta ≤ +40°C
	ATEX Certificate No.: BVS 17 ATEX E 076 X IECEX Certificate No.: IECEX BVS 17.0064X
Approvals, FM	Non Wi-Fi version Only available with intrinsically safe external power supply or battery: IS CL I,II,III/DIV 1/GP ABCDEFG/T4 CL I, Zone 1 AEx/Ex ib IIC T4 Gb Zone 21 AEx/Ex tb [ib] IIIC T60°C Db
	Factory-configured WiFi version Only available for intrinsically safe external power supply or battery: IS CL I,II,III/DIV 1/GP CDEFG/T4 CL I, Zone 1, AEx/Ex ib IIB T4 Gb Zone 21, AEx/Ex tb [ib] IIIC T60°C Db
	FMus Certificate No.: FM18USO258X FMc Certificate No.: FM18CAO123X

Table 1-2: WiFi Module Specification (only for IND256x terminals factory-configured with WiFi module)

Item	Specification
Standard	802.11 b/g/n
Transmitting Power	14dBm (average)
RF Frequency Range	2.412GHz – 2.462GHz
Encryption	WPA-PSK/WPA2-PSK, WEP
Protocol	TCP/IP
Work Mode	Server (only valid via Port 1701), Client
Transmitting distance	Max 40 meters in the open air; typical 20 meters with limited obstruction
Approval	Europe: CE/EMC+CE/RED China: SRRC US: FCC

1.3. Testing Standards

The IND256x terminal has been tested according to the following standards.

EN 60079-0:2012 + A11:2013	General requirements
EN 60079-7:2015	Increased safety "e"
EN 60079-11:2012	Intrinsic safety "i"
EN 60079-18:2015	Encapsulation "m"
EN 60079-31:2014	Protection by Enclosure "t"
IEC 60079-0:2017, Ed. 7.0	General requirements
IEC 60079-7:2017, Ed. 5.1	Increased safety "e"
IEC 60079-11:2011, Ed. 6.0	Intrinsic safety "i"
IEC 60079-18:2017, Ed. 4.1	Encapsulation "m"
IEC 60079-31:2013, Ed .2.0	Protection by Enclosure "t"
FM3600: 2018,	Electrical Equipment for Use In Hazardous (Classified) Locations - General Requirements
FM3610: 2018,	Intrinsically Safe Apparatus and Associated Apparatus for Use in Class I, II & III, Division 1, Hazardous (Classified) Locations
FM3810: 2018,	Electrical Equipment for Measurement, Control and Laboratory Use
ANSI/IEC 60529: 2004	Degrees of Protection Provided by Enclosure (IP Code)
ANSI/ISA 60079-0: 2019	Explosive Atmospheres - Part 0: Equipment - General Requirements
ANSI/ISA 60079-11:2014	Explosive Atmospheres - Part 11: Equipment protection by intrinsic safety "i"
ANSI/ISA 60079-31:2015	Explosive atmospheres - Part 31: Equipment Dust Ignition Protection by Enclosure "t"
CSA C22.2 No. 60079-0:2019	Explosive atmospheres - Part 0: Equipment - General requirements
CSA C22.2 No. 60079-11:2014	Explosive atmospheres - Part 11: Equipment protection by intrinsic safety "i"
CSA C22.2 No. 60079-31:2015	CAN/CSA-C22.2 NO. 60079-31:15 - Explosive atmospheres - Part 31: Equipment dust ignition protection by enclosure "t"
CSA C22.2 No. 61010-1:2012	Safety requirements for electrical equipment for measurement, control, and laboratory use - Part 1: General requirements
CSA C22.2 No. 60529:	2005 Degrees of Protection Provided by Enclosure (IP Code)

1.3.1. Special Conditions for Safe Use

1. The apparatus must be protected from UV-light
2. Electrostatic charging during operation and maintenance has to be excluded. The terminal shall only be installed in areas where operational and process related electrostatic charges are not present.
3. For versions with non-intrinsically safe DC-supply (type key ends with "44" or "46"): There is no galvanic separation between non-intrinsically safe supply circuit and intrinsically safe output circuits:

The non-intrinsically safe supply circuit has to be safely connected to earth. In this case, the intrinsically safe circuits are earthed as well. Along the intrinsically safe circuits, potential equalization must exist.

or









The non-intrinsically safe circuit has to be safely separated from earth (e.g. SELV-circuit).

4. For DC version terminal, the supply circuit shall have at a maximum overvoltage category II according to IEC 60664-1.
5. The cable glands Series HSK-M-Ex... and V-Ms-Ex... according to KEMA 99 ATEX 6971X resp. IECEx BVS 07.0014X are tested with a reduced tensile force (25%) in accordance with clause A.3.1 if IEC 60079-0 and may only be used for fixed installation of group II apparatus. The user shall ensure adequate clamping of the cable.
6. The WiFi antenna is tested for low risk of mechanical danger (impact height 0.4m with 1kg mass) and shall be protected against high impact energy levels.

1.4. Warnings and Precautions

Please read these instructions carefully before putting the new terminal into operation.

Although the IND256x is ruggedly constructed, it is nevertheless a precision instrument. Use care in handling and installing the terminal.

	 WARNING
	DO NOT INSTALL OR PERFORM ANY SERVICE ON THIS EQUIPMENT BEFORE THE AREA HAS BEEN SECURED AS NON-HAZARDOUS BY PERSONNEL AUTHORIZED TO DO SO BY THE RESPONSIBLE PERSON AT THE CUSTOMER'S SITE.
	 WARNING
	ONLY THE COMPONENTS SPECIFIED IN THIS MANUAL CAN BE USED IN THIS TERMINAL. ALL EQUIPMENT MUST BE INSTALLED IN ACCORDANCE WITH THE INSTALLATION INSTRUCTIONS DETAILED IN THIS MANUAL. INCORRECT OR SUBSTITUTE COMPONENTS AND/OR DEVIATION FROM THESE INSTRUCTIONS CAN IMPAIR THE INTRINSIC SAFETY OF THE TERMINAL AND COULD RESULT IN BODILY INJURY AND/OR PROPERTY DAMAGE.
	 WARNING
	DO NOT OPEN WHEN ENERGIZED.
	 WARNING
	POTENTIAL ELECTROSTATIC CHARGING HAZARD - SEE INSTRUCTIONS.
	 WARNING
	DO NOT OPEN WHEN AN EXPLOSIVE ATMOSPHERE IS PRESENT.



WARNING

THE TERMINAL ASSEMBLED WITH WIFI ANTENNA SHALL BE INSTALLED IN A POSITION IN SUCH A WAY THAT THE RISK FOR MECHANICAL DAMAGE IS LOW. REPLACE THE WIFI ANTENNA IMMEDIATELY IF DAMAGED.

1.5. Inspection and Contents Checklist

On receipt of IND256x, check that the packaging is intact. If the box is damaged, check whether IND256x is damaged and, if necessary, lodge a freight claim with the carrier. If the packaging is not damaged, unpack the IND256x, paying attention to its original packaging, and check that nothing is damaged.

- To ensure safe transport, it is best to use the original packaging and the correct packaging method.

The packaging box contains:

- IND256x weighing terminal
- Documentation CD (including manual and certificate of inspection)
- Bag of accessories for use during installation

1.6. Configuration

1.6.1. System Configuration

Figure 1-1 shows the configuration options for the terminal.

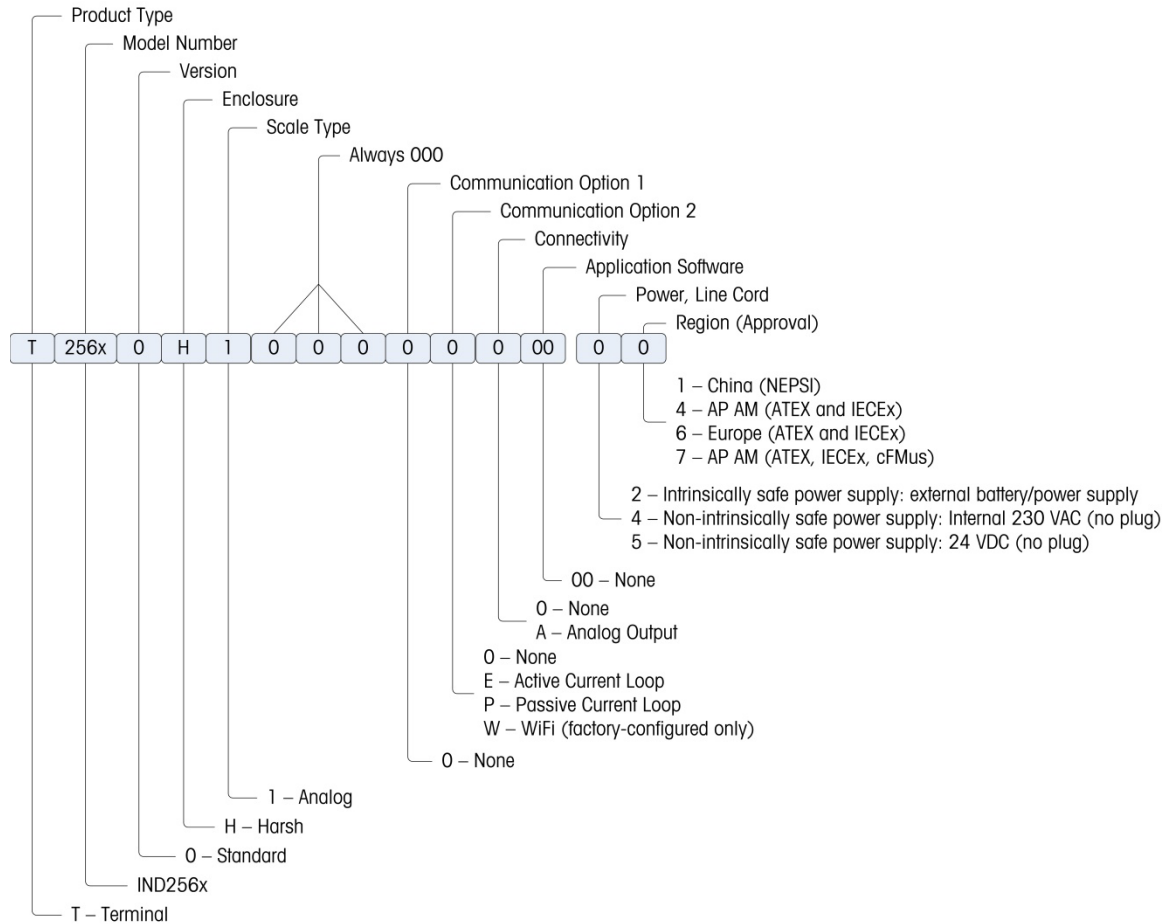



Figure 1-1: IND256x Configuration Chart

	WARNING
	<p>IND256X TERMINALS FACTORY-CONFIGURED WITH WIFI ARE APPROVED FOR USE IN ZONE 1 EQUIPMENT GROUP IIB CLASSIFIED AREAS. IND256X TERMINALS FACTORY-CONFIGURED WITH WIFI MUST NOT BE USED IN EQUIPMENT GROUP IIC CLASSIFIED AREA. USING THE IND256X TERMINAL FACTORY-CONFIGURED WITH WIFI IN A CLASSIFIED AREA FOR WHICH IT IS NOT APPROVED COULD RESULT IN BODILY HARM AND/OR PROPERTY DAMAGE.</p>
NOTICE	
<p>WiFi CAPABILITY IS ONLY AVAILABLE IN IND256x TERMINALS SO CONFIGURED AT THE FACTORY.</p>	

1.6.2. Product Date Code

The manufacturing date or the date code for the terminal can be found on the serial data plate (on the top of the enclosure).

The serial number will begin with a letter and a number (for example B212000371). The letter represents the first three digits of the year per the date code chart in Table 1-3 (the letter “B” in our example represents “201x”) and the number is the unit’s digit of the year (the number “2” in our example). So, “B4” decodes to the year 2014.

Table 1-3: Current and Later Date Code Formats

Date Code	Year	Date Code	Year
A	200x	F	205x
B	201x	G	206x
C	202x	H	207x
D	203x	J	208x
E	204x	K	209x

1.6.3. Connections

The following figure shows the connection locations on the back of the harsh enclosure.

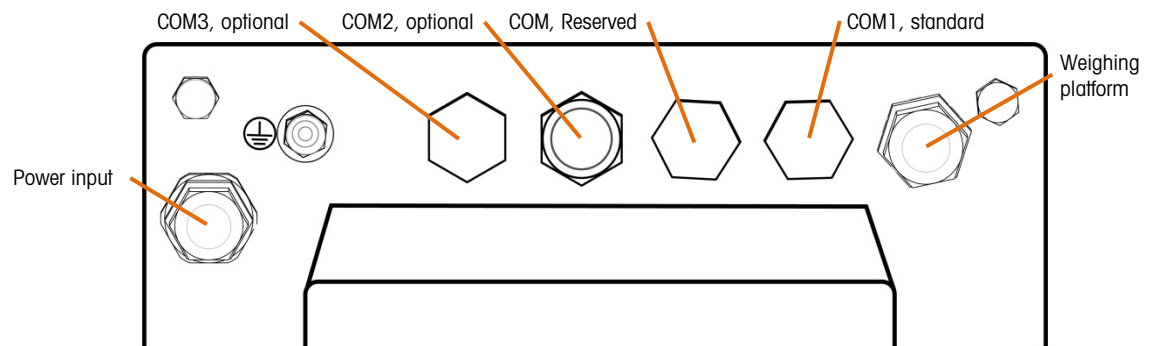

Figure 1-2: IND256x Connection Port Locations

Power input	AC power supply 220V (187-250V 50/60Hz) input (ATEX & IECEx version) <i>or</i> DC power supply 24V(18V-30V) input (ATEX & IECEx version) <i>or</i> intrinsically safe power supply (ATEX, IECEx and FM version)
COM1 (standard)	intrinsically safe RS232
COM2 (optional)	intrinsically safe analog 4-20mA output <i>or</i> Wi-Fi communication module (factory-configured only)
COM3 (optional)	intrinsically safe active current loop <i>or</i> intrinsically safe passive current loop
COM Reserved	Not used

1.6.4. Warnings

1.6.4.1. CENELEC

Connection of EB per Country-Specific Regulations: It must be ensured that the housings of all devices are connected to the same potential via the EB terminals. No circulating current may flow via the shielding of the intrinsically safe cables.

1.6.4.2. cFMus

Connection of EB per ANSI/NFPA 70, Article 504, and ANSI/IA RP 12.06.01 or Canadian Electric Code C22.2: It must be ensured that the housings of all devices are connected to the same potential via the EB terminals. No circulating current may flow via the shielding of the intrinsically safe cables.

1.7. Equipotential Bonding (EB)

Equipotential bonding must be installed by an electrician authorized by the owner. METTLER TOLEDO Service performs only a monitoring and consulting function for this procedure.

Connect equipotential bonding of all devices (power supply unit, weighing terminal, interface converter and weighing platform) in accordance with the terminal diagram and all country-specific regulations and standards. In the process, it must ensure that:

- All device housings are connected to the same potential via the EB terminals.
- No circulating current flows via the cable shielding for intrinsically safe circuits.
- The neutral point for equipotential bonding is as close to the weighing system as possible.

1.8. Operating Environment

When selecting a location:

- Choose a stable, vibration-free surface to mount the terminal
- Ensure there are no excessive fluctuations in temperature and there is no direct exposure to sunlight
- Avoid drafts on the weighing platform (for example, from open windows or air conditioning)
- Calibrate the terminal after any major change of geographical location

1.8.1.1. Temperature and Humidity

The IND256x can be stored and operated at temperatures and relative humidity conditions as listed in Table 1-1.

1.8.1.2. Environmental Protection

The IND256x terminal has environmental protection as listed in Table 1-1.

1.9. Dimensions

Figure 1-3 and Figure 1-4 show the terminal's dimensions. Units are inches and [mm].

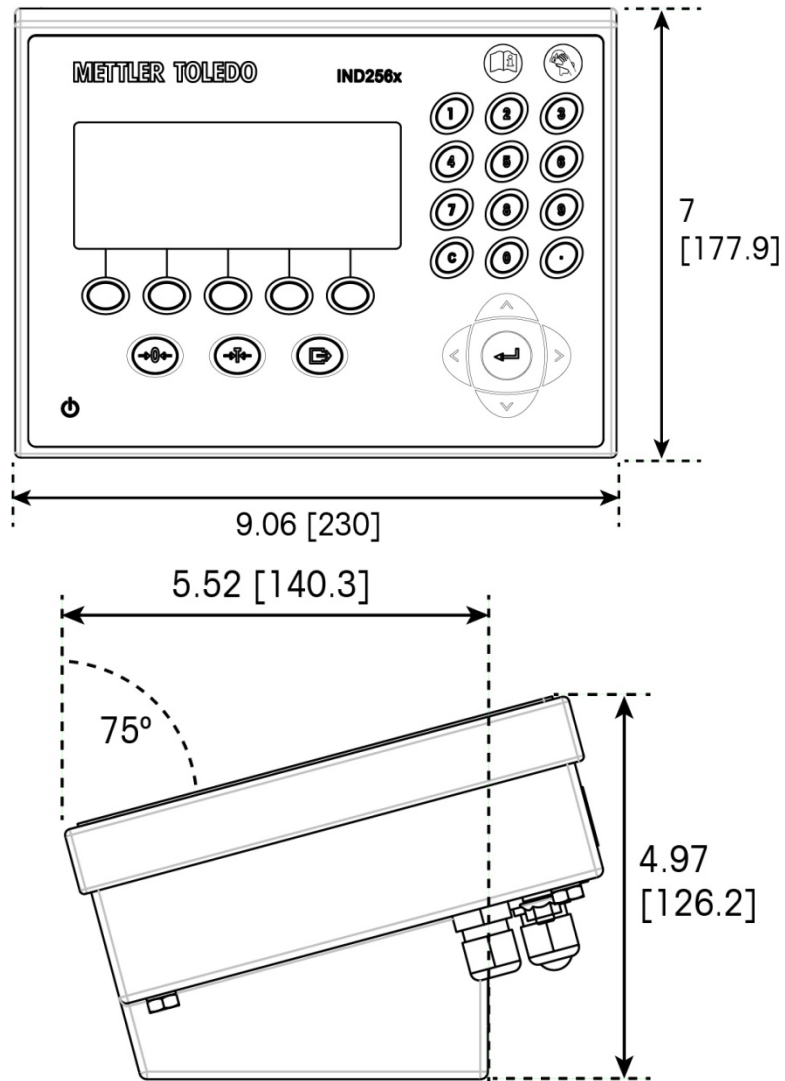

Figure 1-3: IND256x Dimensions, Desktop Installation

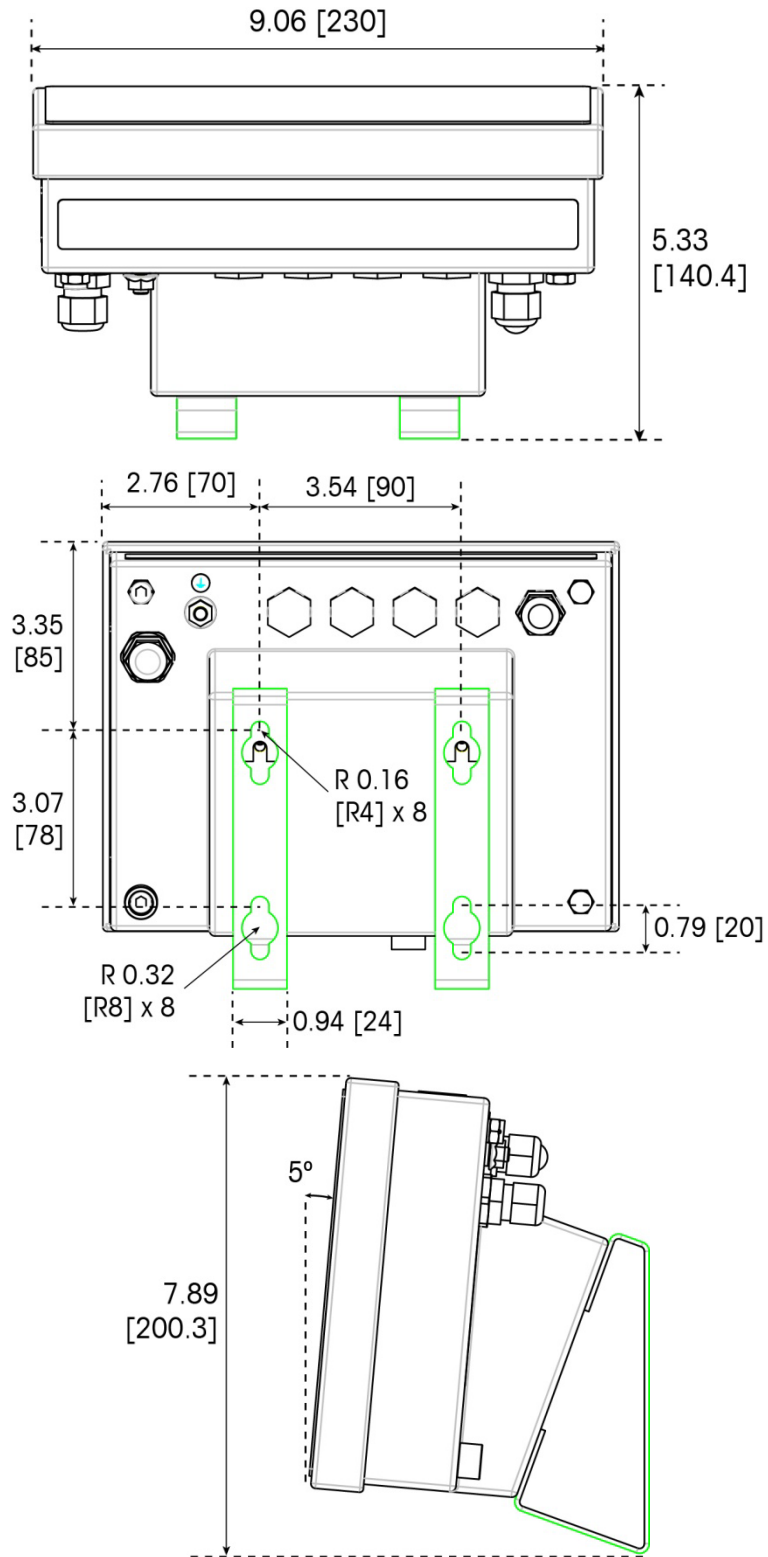

Figure 1-4: IND256x Dimensions, with Fixed Wall-Mount Bracket

1.10. Main Board

The IND256x main board has the following main connections, indicated in Figure 1-5:

1. Analog load cell weighing interface
2. Intrinsically safe power input interface, connection to the power module
3. Flat ribbon harness interface, used to connect the display
4. Intrinsically safe RS232 interface (COM1)
5. Two communication option board interfaces (COM2 and COM3)

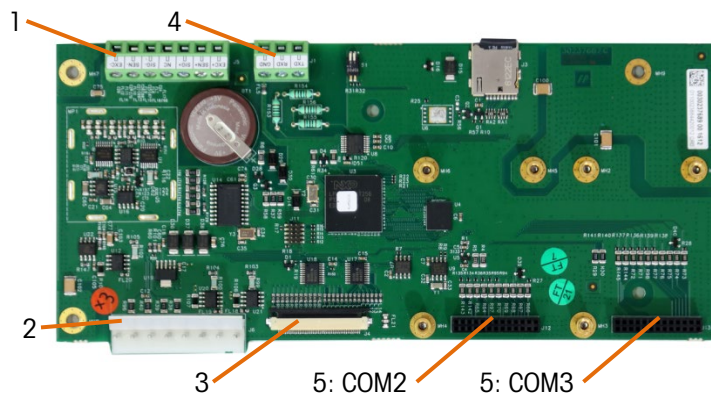

Figure 1-5: IND256x Main Board

1.11. Communication Option Boards

The IND256x can be configured with a maximum of two of the three communication option boards installed inside its enclosure. The options are:

- WiFi communication module (available only in IND256x terminals factory-configured with WiFi)
- Intrinsically safe 4-20 mA analog output
- Active current loop for connection to communication module ACM200 located in the non-hazardous area, or to connect second IND256x terminal configured with passive current loop option
- Passive current loop (used as the second display to connect another IND256x with active current loop)

2 Operation

2.1. Overview

This chapter provides the navigation, basic features and functions of the IND256x terminal. IND256x functions can be configured through the setup menu – refer to Chapter 3, Configuration.

The specific operation of each IND256x terminal depends on the options installed, the functions allowed in the setup menu, and the parameters configured.

2.1.1. User Security: Overview

Access to the terminal's functions can be restricted according to the site's security policies. Restrictions may reflect legal and regulatory requirements, or site-specific standards.

The IND256x uses a password security mechanism to protect the setup menu. The password function is off by default and can be enabled in setup.

Once set, the password must be kept safely. If the password is changed or forgotten, the setup menu and some terminal functions will not be accessible. To recover access and functions, a master reset must be performed, which will reset all user names and passwords and delete any custom configuration.

2.1.2. Metrology Switch

The location of the metrology switch (S1-1) on the mainboard is indicated in Figure 2-1, and its setting positions are shown in Figure 2-2. This switch is off by default; if it is on (the switch is pressed), the terminal is sealed and users will not be able to modify metrologically relevant setup parameters.

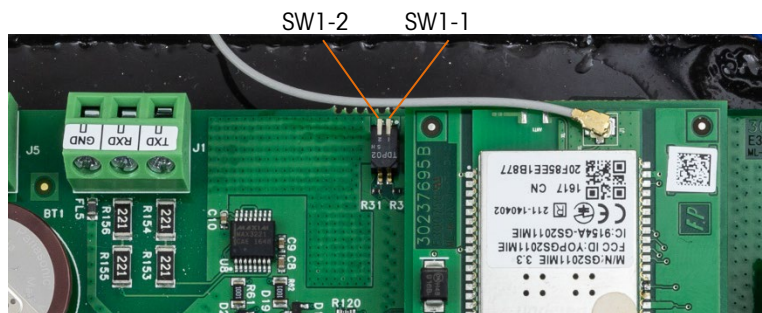
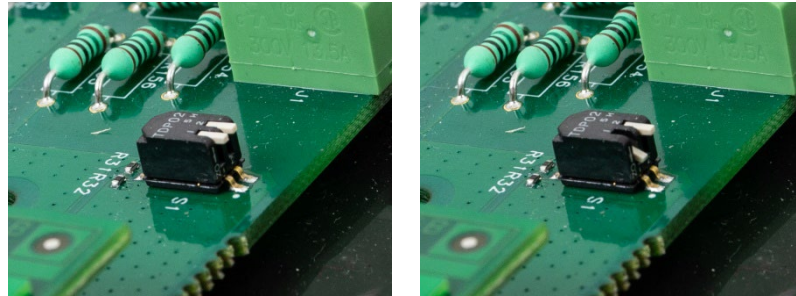

Figure 2-1: IND256x Metrology Switch Location



S1-1 Off

S1-1 On

Figure 2-2: Metrology Switch S1 Settings

2.2. Display and Keyboard

The IND256x has an LCD with white backlight, with a display screen resolution of 240 x 96 pixels. Figure 2-3 shows the main elements of the terminal interface.



Figure 2-3: IND256x keyboard and display

The system line displays system messages, battery and WiFi status indicators, and any asynchronous error information; the middle area includes the application related weight, tare and SmartTrac display, as well as entered values such as target ID and other information; and the softkey icons are displayed at the bottom. To the right of the softkeys, an arrow indicates when more rows of keys are available. These are accessed by using the navigation keys to scroll up (▲) or down (▼). Up to fifteen softkeys can be assigned in three rows. Softkey selection and position are configured in setup.

Three scale function keys – zero, tare and print – appear below the softkeys. At right, 12 numeric keys are used to enter data and commands. These keys include a clear key and a decimal point key.

The ENTER key and four navigation keys are located below the numeric keys. These are used for navigation and data entry during operation and in setup.

An ON/OFF key is located in the left lower part of the front panel.

2.2.1. Navigation Keys

The navigation keys (as shown in Figure 2-3) are used to browse the menu tree and set and apply the window.

2.2.1.1. Up and Down Navigation Keys

These keys move the current cursor up and down to different settings in the menu tree (selected part will be highlighted), move to different fields in the setting page to switch to another page of available softkeys. When the scroll bar indicates that there are two or three pages for configuration fields related to specific parameters, up and down navigation keys are also used to move to next page or previous page. The example in Figure 2-4 displays configuration parameter and it requires two pages to display all relevant configuration fields. The scroll bar indication displays the specific page in the two pages.

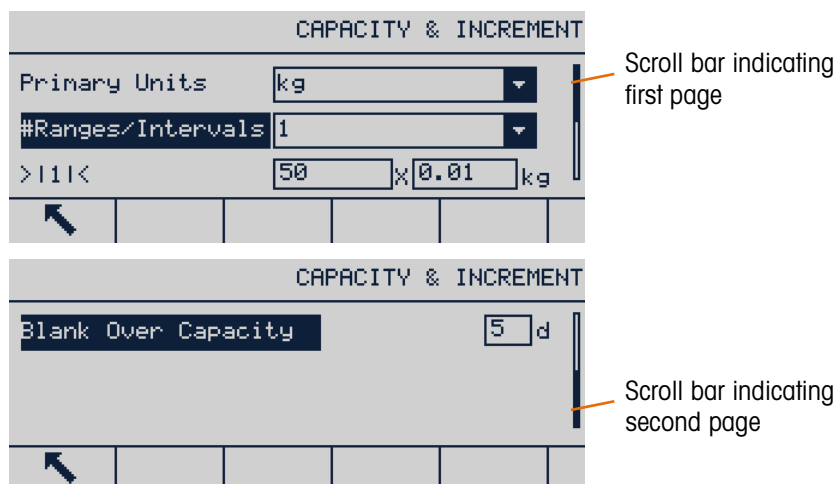

Figure 2-4: Scroll Bar Example, Indicating Configuration Fields on Two Pages

Press the DOWN navigation key to move from Page 1 to Page 2. Press the UP navigation key to move from Page 2 to Page 1.

2.2.1.2. Left and Right Navigation Keys

The left and right navigation keys are used to:

- Move into or out of levels in the menu tree
- Move within an editable field during data entry
- Allow left- and right-scrolling to the left and right, to view all available information in the window

2.2.1.3. Enter Key

The ENTER key is used to:

- Open a setup page to view parameters, and enter the parameter's configuration field in order to modify or select its value

- Confirm the set value in the menu
- Accept the new value entered in the field and move the focus to next field label

















2.2.2. Softkeys and Icons









There are five softkey buttons (indicated in Figure 2-3) along the bottom of the display window. These correspond to the softkey icons displayed on-screen immediately above each key. Five softkey icons can be displayed simultaneously, with a maximum of 15 overall, divided into three separate rows. The down and up symbols to the right of the icons indicate the availability of more rows; use the UP and DOWN navigation keys to display additional rows.

Softkey configuration and customization is detailed in Chapter 3, Configuration.

The softkey and application displays are identified by icons. Table 2-1 lists these icons and their functions and classifies them according to their use in HMI.

Table 2-1: Softkey Icons and Functions

Icon	Function	Icon	Function
Scale Calibration Icons			
	CalFree™		Zero calibration
	Span calibration		Step calibration
	Start calibration test		
Table, Memory and Function access			
	Tare Memory (access the tare table)		Target Value View (access the target value table)
Alibi	Alibi Memory	TLog	Transaction log
	Report (set printing of Alibi memory, transaction log, tare and target table)		Target Value
	Tare Value view	ID	ID (customized information, ID1, ID2 and ID3 available)
	Totals Report		Transaction Counter
	Enter setup menu		Date/Time setting
	Print		Repeat Print

Icon	Function	Icon	Function
	View System Information		
Edit			
C	Clear All		Exit (return to previous window)
	Delete		New
	Edit		Confirm input or transaction
	Cancel (exit without saving)		
Display Icons			
x10	Expand displayed resolution by 10		Contrast Control
Min-Weigh	Minimum Weight function		Unit switch – change units

2.2.3. Scale Function Keys

The scale function keys in Figure 3-2 are:

- 
ZERO

When the weighing platform is empty, the terminal displays 0 kg. Gross weight zero reference is recorded during calibration. If pushbutton zero is allowed in the configuration and the weight is within the zero range, the zero function key may be pressed to capture a new gross weight zero reference point.
- 
TARE

Tare refers to the weight of an empty container. It is generally used to determine the net weight of the container's contents. Press the tare function key when an empty container is placed on the weighing platform to display a net weight of zero. When material is added to the container, the terminal displays their net weight.

When the empty weight of the container is known, the tare may be entered using the numeric keypad and pressing the tare function key to store the value. The terminal will display the net weight of the materials in the container. The keyboard tare must be allowed, so that this method can be used for key tare operation. If the auxiliary tare display is allowed, the tare value and tare type will be displayed in the bottom left of the screen.

 - Pushbutton tare must be enabled in setup in order to use either of these methods for tare operation.
- 
PRINT

Press the print function key to initiate a demand output of data in the print template configured in setup. A serial or WiFi print connection must be configured to connect the template to the selected serial or WiFi port. When a print command is issued, they system line displays Printing for 3 seconds.



CLEAR

In net weight mode, press the clear function key to clear the current tare value. The display will return to gross mode. Clear can be operated regardless of whether there is motion on the platform. Please note that once the tare value has been cleared, it can no longer be read back. It is necessary to re-execute the tare process described above.

During numeric input using the keypad, the clear function is similar to a backspace key. Use the right arrow key to place the cursor at the end of the data to be deleted and press the clear key. A character is deleted by each press of the clear key. When the data input box is entered for the first time, the previous input will be selected; in this case, press clear to delete the existing value.

2.2.4. Numeric Keypad

When data input is required, use the 12-key numeric keyboard (shown in Figure 2-5) to enter the numbers.

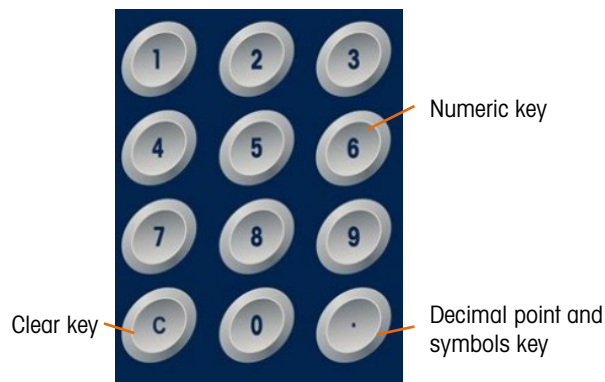

Figure 2-5: Numeric keyboard layout

Locate the cursor in the field as described in section 2.2.1, above) and press the numeric key to enter the appropriate data. When necessary, press the decimal point key to enter a decimal point.

During data input, the clear key function functions like a backspace key. Locate the cursor at the end of the data to be deleted and press C. One character is deleted by each press of the clear key. When a data input field is selected for the first time, the whole data string is selected state. Press clear to delete the existing input.

The Escape **Esc** and Exit keys exit the data input process and abandon any newly-entered data. Data that was in the field before the entry process began will be retained.

Once the required letter, number and character are entered in the proper field of the window, press Enter to accept the input.

2.3. Data Input

The standard keypad only supports the entry of numeric characters; however, alphabetic entry is supported for specific functions, such as the ID table shown in Figure 2-6. When the keypad softkey is displayed, pressing it opens the alpha character entry screen. INS-ABC will appear at upper right, to indicate the entry mode.



Figure 2-6: ID Input Display







Once in alphanumeric entry mode, use the up  and down  keys to select different character blocks. Once the correct block is selected, use the numeric keys to select the character for input. In the example shown in Figure 2-7, press  for A,  for B, or  for C. Use the left  and right  navigation keys to move the position of the selection in the array of character options.



Figure 2-7: Alphanumeric Input Screen









Use the softkeys  and  to select alternative input modes. A further two softkeys  and , select and delete the character next to the cursor, respectively.

Table 2-2: Softkey Function

Softkey	Function
	Lower or upper case letters
	Symbols or numbers
	Select the character next to the cursor; the next character entry will overwrite the selected character.
	Delete the character next to the cursor

When the data entry is complete, press ENTER  to confirm.

2.4. Main Display

Figure 2-8 shows the main display.

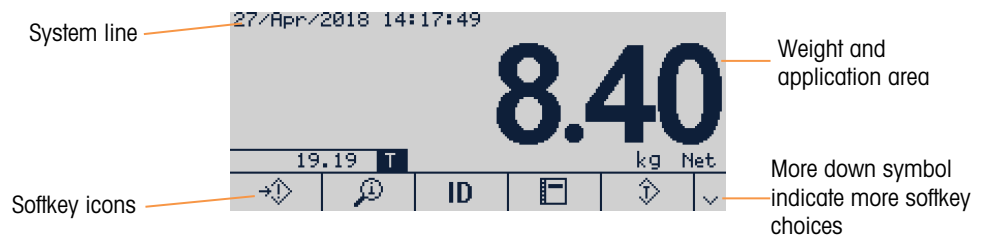

Figure 2-8: Main Display

The appearance of the display will vary according to the terminal configuration, but it can contain:

- System Line** Displays system information and status, such as date/time, error message, indication of WiFi connection
- Weight and Application Area** Displays the weight, unit, tare and specific weighing data of other applications
- Softkey Icons** Displays the icons of currently available softkey functions. If the More Down and More Up symbol is displayed at right, further softkeys are available in additional rows.

2.4.1. WiFi Status Indication

The WiFi status indicator shows when a WiFi connection exists, and displays bars to indicate signal strength.

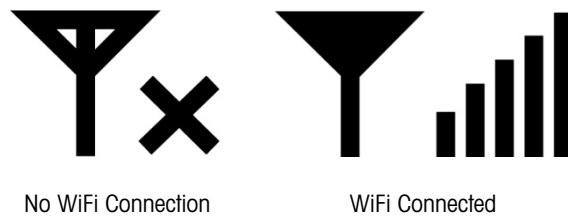

Figure 2-9: WiFi Status Indicator

3 Configuration

This chapter provides information about configuring the IND256x from the setup menus.

3.1. Enter Setup

Click the SETUP icon  to enter the terminal's setup menu. If the user name and password are set, a login screen appears. In this case, the setup menu may be entered only by entering a correct user name and password.





Figure 3-1: Login Screen



Figure 3-2: Password Error Message

3.1.1. Enter Password

1. Press  to display the password input box.
2. Enter the numeric password.
3. Press  key. If the password is correct, the setup menu tree will appear; if the password is incorrect, an error prompt will be displayed. Press ENTER to directly exit to the weighing interface.

3.2. Exit Setup

Press Exit  to exit to the main menu.

3.3. Setup Menu

The setup menu of IND256x is shown in Figure 3-3.



Figure 3-3: Setup Menu

Use the UP, DOWN, LEFT and RIGHT navigation keys to select item. The selected menu item appears in a reverse highlight. When the desired item is selected, press OK to enter the submenu.

3.3.1. Setup Screens

The setup screens are used to view, enter or modify setup parameters.

3.3.1.1. Selecting Parameters

Use the UP and DOWN navigation keys to move between different parameter labels. If the setup screen of a parameter exceeds one page, a vertical scroll bar will appear in the right to indicate this. The dark area of the scroll bar indicates which part of the screen is currently displayed.

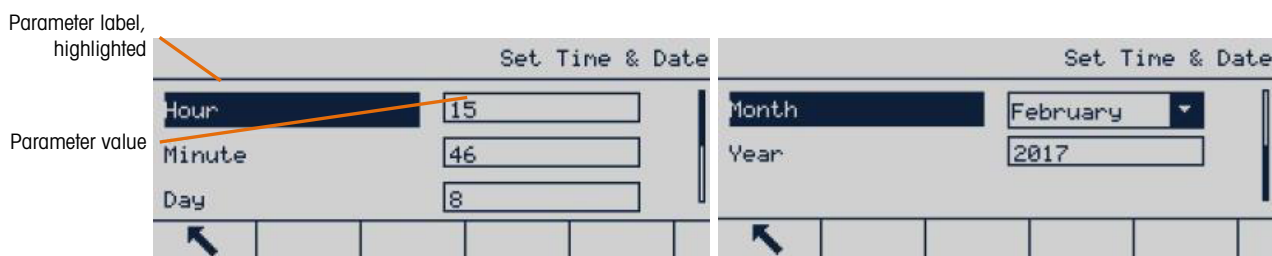

Figure 3-4: Setup Screen Example (Time and Date Setting)

3.3.1.2. Entering Data

Press Enter to move focus from the field label to the selection box or textbox; enter or edit data here.

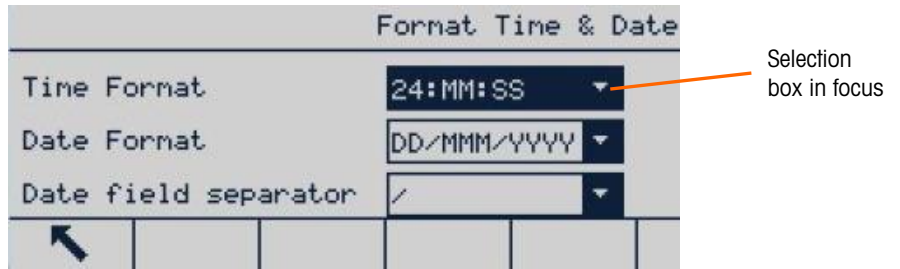
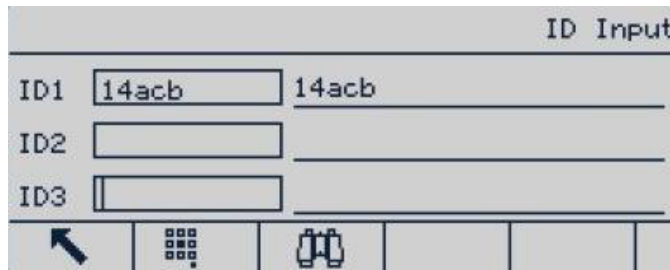

Figure 3-5: Setup Screen

If the parameter values are provided in a drop-down selection box, press ENTER to select the current value. Choose other values from the selection box using the UP and DOWN navigation keys. Once the desired value is selected, press OK to confirm. Focus will move to the next parameter label.

If a parameter value is a textbox and allows alphanumeric entry, press the keypad softkey  to use the keypad.



4.

Figure 3-6: Select Parameter

Refer to section 2.3, Data Input, in chapter 2, Operation, for further details.

3.4. Configuration Overview

All configuration screens may be accessed from the setup menu tree. In each branch's main screen, use the navigation keys to select the required setup screen, and then press Enter to display that menu.

There are five main submenu branches in the setup menu:

- | | |
|-------------|---------------|
| Scale | Application |
| Terminal | Communication |
| Maintenance | |

This chapter explains the available parameters, their settings, and the use of each menu.

3.5. Scale

- If the metrology switch SW1-1 is ON, the user will not be able to access the Scale parameter menus. Refer to section 2.1.2., Metrology Switch, in chapter 2, Operation.

The scale menu is used to configure the following parameters:



Figure 3-7: Scale Menu, Two Pages

A Reset operation located at the bottom of the list may be executed to reset some parameters in the Scale menu to default values. This action does not clear metrological data.

3.5.1. Scale Type

The Scale Type menu is used to set the scale name, type, approval method and approval number. Press the Exit softkey  to return the display to the Scale menu.



Figure 3-8: Scale Type Menu

3.5.1.1. Name

The Name field allows a name to be assigned to the scale. Enter identifying information of no more than 20 characters and press Enter to store the name and move to the next parameter label.

3.5.1.2. Scale Type

Type field indicates the type of scale supported by the terminal and allows selecting remote display mode. If Remote is selected, the approval option will be disabled. Options are:

Analog [used for analog version by default], Remote

3.5.1.3. Approval

Approval refers to the approval configuration of the terminal and platform.

Various Approval methods may be legally used for corresponding countries and regions. The Approval selection list contains:

- None [default]
- Thailand
- Canada
- Australia
- OIML
- USA

If any approval method is selected, the parameters related to metrology in the Scale menu will be locked and cannot be modified. Select OIML approval for China.

3.5.1.4. Certification No.

Enter an approval number of up to 20 digits.

3.5.2. Capacity & Increment

Use this menu to set the primary weighing unit, range and division value and overload display range.

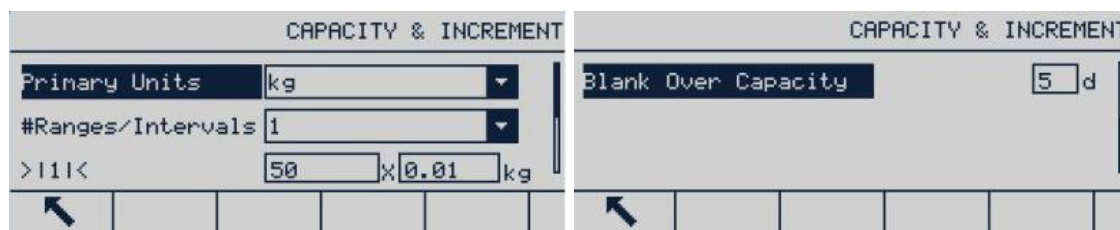

Figure 3-9: Capacity & Increment Screens

3.5.2.1. Primary Unit

Set the Primary units from the options in the selection box, including:

g, kg [default], lb, t, ton

3.5.2.2. Range/Intervals

Select multi-interval or multi-range mode and then set the number of ranges or intervals from the selections:

1 [default], 2 intervals, 2 ranges, 3 intervals, 3 ranges

3.5.2.2.1. > | 1 | < – range/interval value 1

Specify the capacity and then the increment size for range or interval

3.5.2.2.2. > | 2 | < – range/interval value 2

When two ranges or intervals are selected, the second range or interval value should be entered.

The range 2 must be greater than the input value of range 1.

3.5.2.2.3. > | 3 | < – range/interval value 3

When three ranges or intervals are selected, the third range or interval value should be entered.

3.5.2.3. Blank Over Capacity

Select the appropriate number of divisions to determine how many displayed divisions above capacity the terminal can display before the display is blanked. In this overcapacity situation, a dotted line will be displayed instead of a weight value, and the immediate data output is disabled.

3.5.3. Calibration

The GEO code adjustment value (gravitational acceleration factor), base (scale) serial number, calibration unit and linearity adjustment are set in the calibration screen. When the Scale Type is set as Remote, the calibration branch is not available.



Figure 3-10: Calibration Screens

3.5.3.1. GEO Code

In the GEO Code field, enter the appropriate geographical adjustment value for current geographic position. The geo code is numbered from 0 to 31. Refer to Appendix C, Geo Codes, to determine the correct GEO code for the installation site.

The GEO value is used to translate factory calibration values to local settings, making it unnecessary to do an on-site calibration. It cannot be adjusted for a weighing system which has been calibrated at the customer's site.

3.5.3.2. Base Serial Number

If appropriate, enter the serial number of the connected scale. Entries of up to 13 characters are accepted.

3.5.3.3. Calibration Units

The available calibration units are the same as the primary units, and include:

g, kg [default], lb, t

3.5.3.4. Linearity Adjustment

Select linearity adjustment from the selection box. The options are:

- Disabled [default] Only use zero and span
- 3 points Use zero, midpoint and high point
- 4 points Use zero, low point, midpoint and high point
- 5 points Use zero, low point, midpoint, mid-high point and high point

3.5.3.5. Calibration SoftKeys

The softkeys displayed in the calibration setup screen are used for several calibration processes.

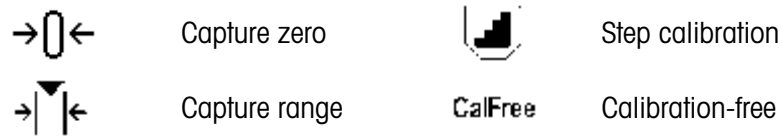

3.5.3.5.1. Capture Zero

The Capture zero softkey  triggers an independent operation to reset the scale zero condition.

Capture Zero Steps



1. Press capture zero softkey .
2. A message appears instructing the user to clear the platform.
3. Clear the platform and press start softkey  to display capture zero operation status.



Figure 3-11: Zero Calibration

- Press Escape softkey  to cancel the zero calibration process and return the display to previous screen.
4. When the operation is complete, a final status message appears, indicating that zero capture is complete.
 - If there is scale motion during the zero capture process, the terminal will accept the unstable weight reading and then display a warning message to indicate the use of an in-motion value. This message offers Yes and No options, and the user may reject or accept the calibration. Move the cursor to the desired action and then press ENTER.



Figure 3-12: Zero Calibration (Unstable)

5. When zero capture is successful, a message will appear, showing "Capture zero ok". If the zero capture is not successful, an error message appears, showing "Capture zero failure ". In this case, repeat the zero capture process. If the process continues to fail, contact your METTLER TOLEDO representative for assistance.



Figure 3-13: Zero Calibration (Failed)

6. Press the Esc softkey **(Esc)** to return to the calibration screen.

3.5.3.5.2.

Capture Span

The Capture Span softkey **→|↕|←** starts the process, which can be performed independent of capturing zero. To capture span, enter the test load in the appropriate field. The method used depends on whether Linearity is disabled or enabled.

If Linearity is Disabled

7. Press CAPTURE SPAN **→|↕|←**. The capture span setup screen will appear. Enter the full-scale calibration weight, then press ENTER.

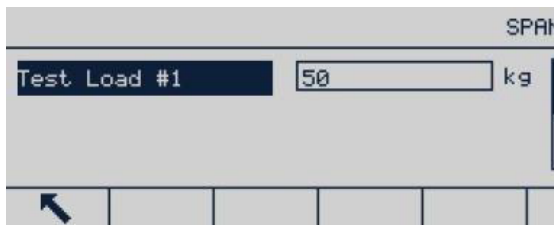

Figure 3-14: Test Load Entry Screen

8. Press START softkey **↕** to start the weight capture operation status. A display will indicate progress. When the operation is finished, a status message appear indicating that span has been captured successfully.
- If required, press ESC softkey **(Esc)** to cancel the calibration process and return the display to previous screen.



Figure 3-15: Span Calibration in Progress

9. If capture span is successful, an approval message appears, showing "Capture span ok ". If the capture span is not successful, an error message appears, showing "Capture span failure". Repeat the capture span steps in case of calibration failure. If the process continues to fail, contact your METTLER TOLEDO representative for assistance.

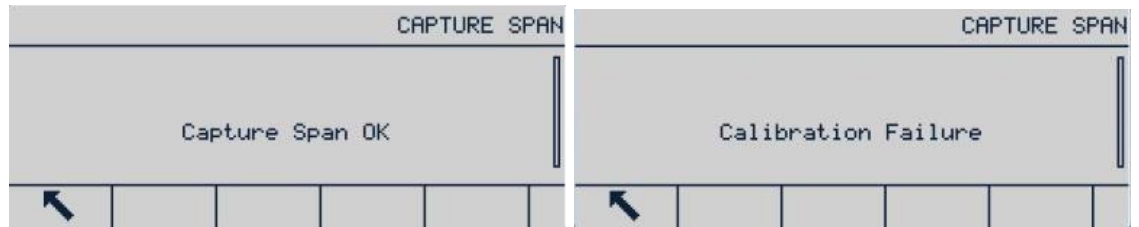

Figure 3-16: Span Calibration, Success and Failure

- If there is scale motion during the span capture process, the terminal will accept the unstable weight reading and then display a warning message to indicate the use of an in-motion value. This message offers Yes and No options, and the user may reject or accept the calibration. Move the cursor to the desired action and then press Enter.

10. Press the ESC softkey to return to the calibration screen.

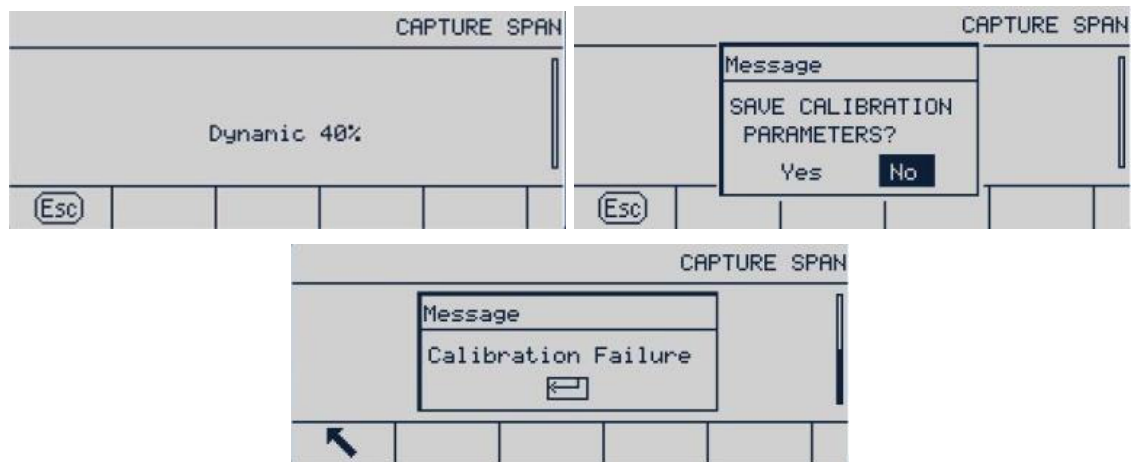

Figure 3-17: Span Calibration (Unstable)

If Linearity is Enabled

In this case, the screen will display two calibration weight input boxes. Enter load weights #1 and #2 and press ENTER to confirm. Then enter the span calibration interface and press Start. The message "Capture span ok" shows that the calibration is successful.

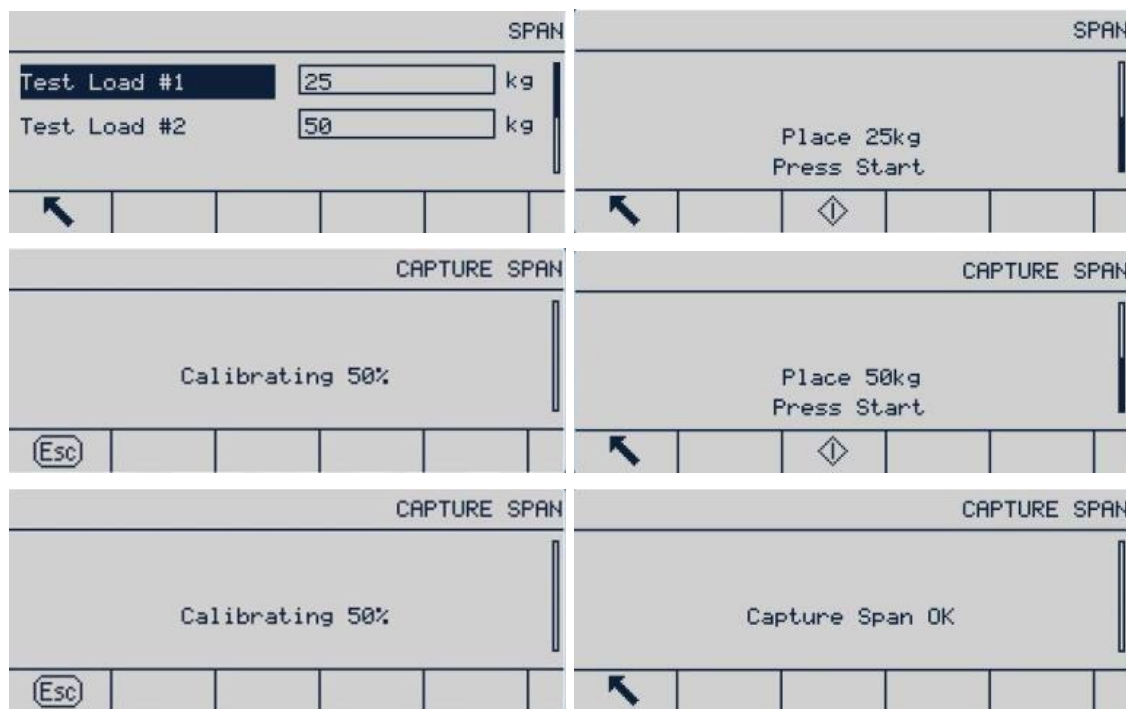

Figure 3-18: Span Calibration (Success)

"Calibration Failure" will be displayed if the terminal does not succeed in capturing the span.



Figure 3-19: Span Calibration (Failed)

- If there is scale motion during the span capture process, the terminal will accept the unstable weight reading and then display a warning message to indicate the use of an in-motion value. This message offers Yes and No options, and the user may reject or accept the calibration. Move the cursor to the desired action and then press Enter.

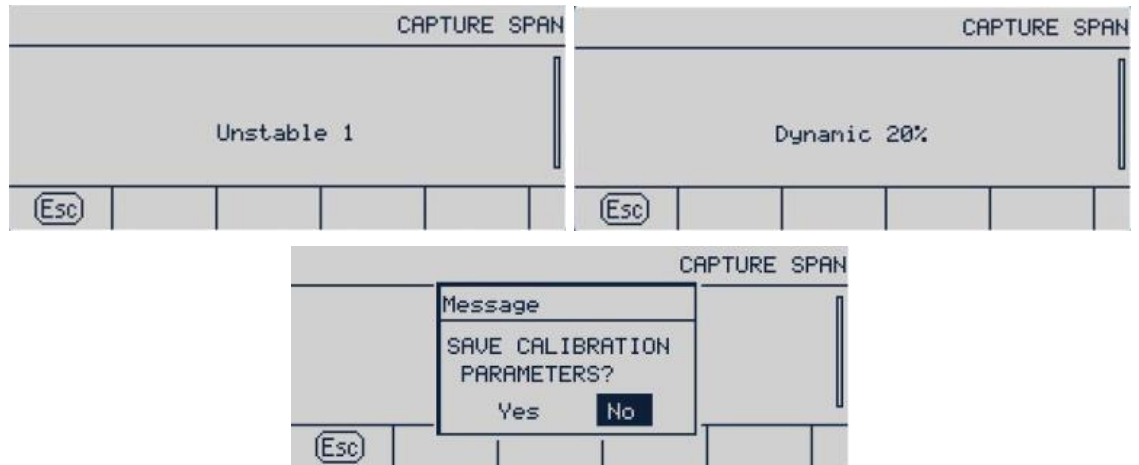



Figure 3-20: Range Calibration (Motion)

3.5.3.5.3. Step Calibration

In step calibration, the same amount of test weight is added at each step of the calibration procedure.

To Execute Step Calibration

1. Press the step calibration softkey . The step calibration setup screen appears.

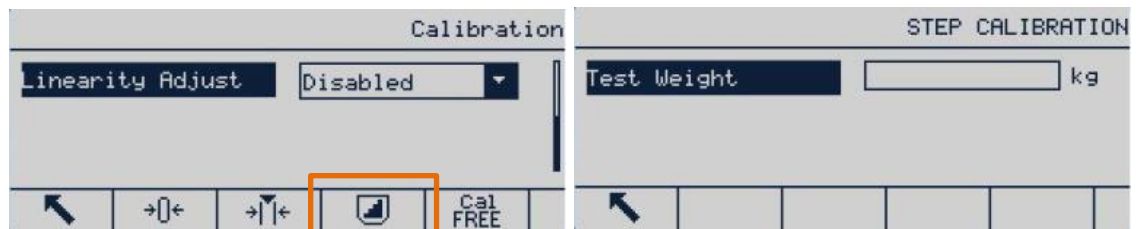





Figure 3-21: Accessing Step Calibration

2. Press ENTER to access the target weight field, and enter the weight of the test load. (The same amount of test load weight will be used in each step). Press OK to confirm.



Figure 3-22: Entering Test Weight Value

3. Press the Start softkey . The step calibration screen appears. This screen displays the target weight entered in previous screen, together with the prompt "Add test weight". Place the test weight and press OK .
4. Place the correct test weight on the scale and press OK .

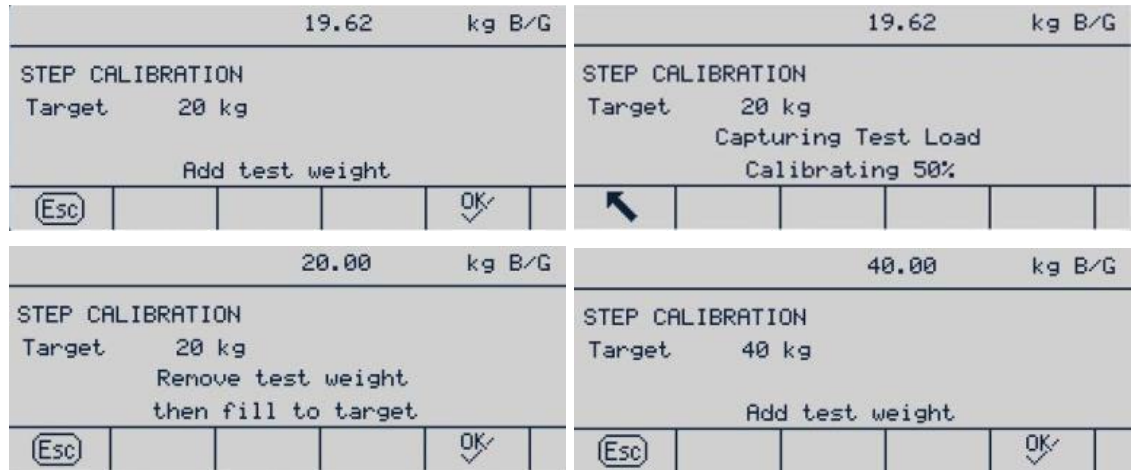

Figure 3-23: Step Calibration in Progress

- Repeat steps 3 and 4 until sufficient calibration steps have been completed. Once the process is complete, a screen will show the final target value, then show a "Calibration Successful" message.



Figure 3-24: Step Calibration Sequence

- Press Enter to return to the calibration screen.

At any step in the procedure, press EXIT to stop the process and return to the calibration screen.

3.5.3.5.4. CalFree (Weight-Free Calibration)

The CalFree softkey **CalFree** provides access to the span calculation screen and can achieve platform calibration without test weights. Before CalFree operation, make sure that the correct value has been entered for the analog gain jumper. If the value is not set correctly, it will cause error in CalFree calculation.

Range Calibration Using CalFree

- Press CALFREE softkey **CalFree** and CalFree screen appears.
- Enter the load cell capacity, press ENTER and select appropriate unit.
 - The sum of the capacities of all the load cells should be entered here. For example, for a storage tank with three 5000kg sensors, the sensor capacity will be 3 x 5000 kg, i.e. 15000 kg.
- Enter the rated load cell sensitivity output value and then press ENTER.

- If several load cells are used, the average value of the sensitivity of all cells should be entered here. The average output is determined by adding the output of all cells and then dividing by the number of cells.
4. Enter the estimated preload value in relevant field. The estimated preload is any input. During the calibration, the terminal tests whether there is analog/digital (A/D) converter input saturation in full platform range. If a value is entered in this field, the estimated preload is accounted for in the calculation. If the preload is unknown, leave this field blank.
 - This preload value is only used to determine the overload conditions and not used as zero reference point. The zero reference point must be captured by the normal zero calibration procedure.

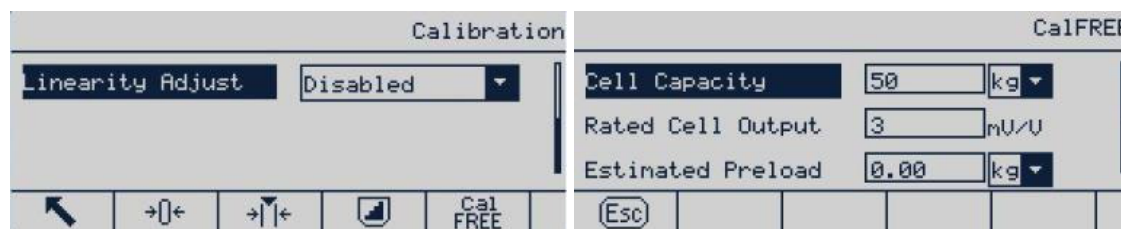

Figure 3-25: Configuring CalFree



5. Press OK  in the pull-down menu.



Figure 3-26: CalFree Calibration Process

6. If calibration succeeds, a message will appear, showing "Calibration ok". If calibration fails, repeat the CalFree procedure. If the process continues to fail, contact your local METTLER TOLEDO representative for help.
7. Press the EXIT softkey  to return to the calibration screen.

3.5.4. Zero

Zero function is used to set or reset the initial zero reference point of the IND256x. There are three zero setting modes:

- Auto zero
- Power up zero
- Pushbutton zero

This section describes the auto zero, auto zero range, under zero blanking, power up zero and pushbutton zero settings.



Figure 3-27: Zero Screens

- Press the Zero key within the allowed zero range and the weighing display controller will clear the current weight value to zero.

If the platform is motion, the motion indicator will appear, and the terminal will not be able to complete the zero operation.

3.5.4.1. Auto Zero

Use the Auto Zero parameter to select auto zero maintenance parameters. The options are:

Disabled, Gross [default], Gross and Net

3.5.4.2. Auto Zero Range

Auto zero maintenance (AZM) allows IND256x to compensate for a small amount of weight deviation (such as from debris on the scale), and return it to the center of zero. When the terminal is within the AZM operation range and is not in motion, the terminal makes small adjustment to current zero reading to gradually approach the true zero center weight. When the weight is beyond the programmed AZM range, this function will not work.

The auto zero tracking range is in the unit of division(d) value. The options are

0.5d [default], 1d, 3d, 10d

3.5.4.3. Under Zero blanking

The underload range determines how far below calibrated zero the scale weight can fall before the display blanks (displays a dotted line). This range is defined in divisions. The options are:

Disabled [default], 10d, 20d

3.5.4.4. Power Up Zero

If Power-Up Zero is enabled, the terminal attempts to capture zero at power up, provided the scale is within the range specified here. If Power up zero is disabled, the initial reference at power up will be recovered to the most recent zero reference. Power Up Zero Range

When Power up zero is enabled, – Range and + Range fields will display. These are used to set the range above and below the original calibration zero point of the platform within which the terminal can use power up zero. The range unit is defined as a percentage of calibrated span. The options are:

Disabled [default], +/-2%, +/-10%

For example, if the power up zero and range setting is set at 2%, the power up zero will occur only when the weight reading in the scale is less than 2% of the scale range above the original scale calibrated zero reference.

If power up zero capture is enabled and the weight in the scale is beyond the zero capture range, the display will indicate EEE until the weight is adjusted to within the range.

3.5.4.5. Pushbutton Zero

If Pushbutton Zero is enabled, the ZERO key in the keyboard can be used to capture a new zero reference point. Pushbutton zero options are:

Disabled, +/-2% [default], +/-20%

- If Pushbutton Zero is disabled, a remote zero command may still be executed through SICS, CPTZ and SMA commands from PC, discrete input or PLC. To set the zero point range of such remote zero functions, enable pushbutton zero first, select the pushbutton zero range and then disable pushbutton zero.

3.5.4.5.1. Pushbutton Zero Range

If Pushbutton zero is enabled, – Range and + Range fields will display. These are used to set the range above and below the original calibration zero point of the platform where Pushbutton zero can be used. The range unit is a percentage of calibrated span.

For example, if the pushbutton zero and range setting is set at 2%, the pushbutton zero will occur only when the weight reading in the scale is less than 2% of the scale range above the original scale calibration zero reference. If the pushbutton zero and range setting is set at 2%, the pushbutton zero will occur only when the weight reading in the scale is less than 2% of the scale range below the original scale calibration zero reference.

3.5.4.5.2. Using Pushbutton Zero

The Pushbutton (semi-automatic) zero function can be carried out in two ways:

- Press the ZERO scale function key
- Serial command (SICS or CTPZ protocol)

3.5.5. Tare

Tare refers to the weight of an empty container. Tare is used to subtract the weight of the container from the scale gross weight to determine the net weight of the containers contents. If the platform is in motion, Tare is disabled. This branch provides parameters for tare type, auto tare and auto clear.

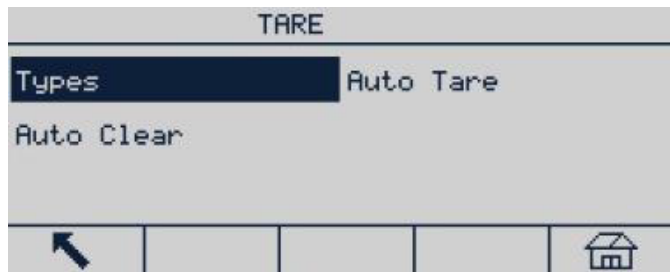



Figure 3-28: Tare Menu

1. Press the Tare key to use current weight as tare. The display will switch from gross weight mode to net mode, and show a net weight of zero. The net weight indicator will display.
2. If the scale is in motion, the terminal will be unable to perform the tare function.
3. Press the CLEAR  key to clear current tare value. The display will return to the gross weight mode. The net weight cursor will be converted to gross weight cursor.

3.5.5.1. Tare Type

Use the Tare Types setup screen to enable or disable pushbutton tare, keyboard tare and net sign correction.

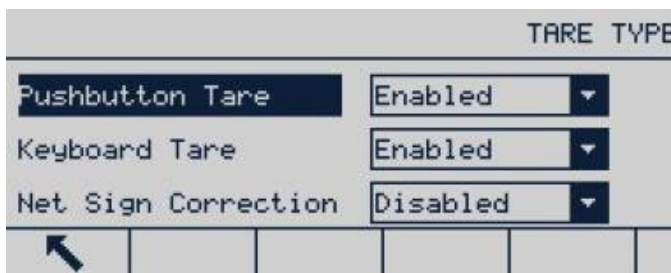



Figure 3-29: Tare Type Screen

3.5.5.1.1. Pushbutton Tare

If pushbutton tare is enabled, tare can be captured by placing an empty container on the scale and pressing the Tare key . The terminal will display a zero net weight and the net weight mode indicator. When the container is filled and placed back on the scale, the net weight of the material will display. The options are:

Disabled, Enabled [default]

- If Pushbutton Tare is disabled, remote tare can still be executed through SICS, CPTZ and SMA commands and discrete input from PC or through PLC command.

3.5.5.1.2. Keyboard Tare

When the keyboard tare is enabled, use the numeric keypad to enter the given value (preset tare) of the empty container weight (tare), then press ENTER . The terminal will display the net weight of the content in the container. Keyboard tare is automatically rounded to the nearest display division. Options are:

Disabled, Enabled [default]

3.5.5.1.3. Net Sign Correction

Net sign correction is used for factory receiving and shipping applications. If net sign correction is enabled, the terminal will switch the gross weight and net weight fields in the printed bill when necessary, so that the larger weight is always the gross weight and the smaller weight always the tare, and their difference is always positive net weight. Net sign correction affects the print data output and the terminal's displayed weight. Continuous data output will continue to display negative net weights. Options are:

Disabled [default], Enabled

Net sign correction will use pushbutton tare, preset tare or the tare record operation stored in the Tare Table. Table 3-11 displays the example of the weight value with and without net sign correction. In this example, the tare memory value is 53 kg and the existing weight on the scale is 16 kg.

Table 3-1: Weight Value With and Without Net Sign Correction

Printed and displayed	Net Sign correction	
	Disabled	Enabled
Gross weight	16 kg	53 kg
Tare	53 kg	16 kg
Net weight	- 37 kg	37 kg

- When net sign correction is enabled, the tare field read from the display will be marked the letter "M" to indicate "memory" rather than "T" or "PT".

3.5.5.2. Auto Tare

Use the Auto Tare screen to enable or disable auto tare, set tare and reset threshold weights, and enable or disable motion check. Auto tare options are:

Disabled [default], Enabled

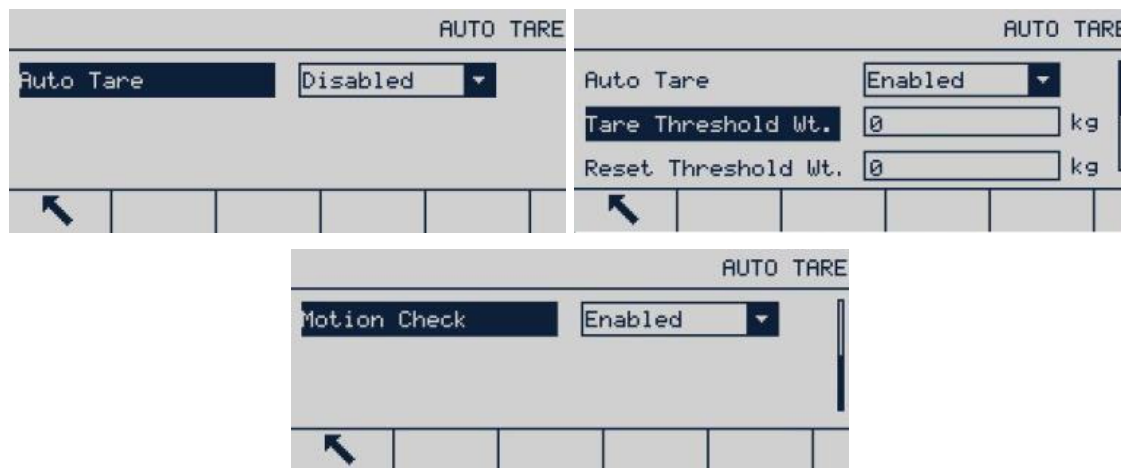

Figure 3-30: Auto Tare Screens

3.5.5.2.1. Auto Tare

When auto tare is enabled and a container heavier than the threshold weight is placed on the scale, the tare operation is performed automatically once the scale is stable. Options are:

Disabled [default], Enabled

3.5.5.2.2. Tare Threshold Weight

When the weight on the scale exceeds the set tare threshold and is stable, the terminal tares automatically.

3.5.5.2.3. Reset Threshold Weight

Reset threshold weight must be less than the tare threshold weight. When the weight on the scale falls to below the reset threshold, e.g. when the load has been taken away, the terminal compares the current weight on the scale with the reset threshold weight. If current weight is below the threshold value, the terminal is ready to execute the next auto tare operation, as described in section 3.5.5.2.2.

3.5.5.2.4. Motion Check

When Motion Check is enabled, the terminal will check whether the weight on the scale is stable, so as to judge whether to execute auto tare operation. Options are:

Disabled, Enabled [default]

3.5.5.3. Auto Clear

Use the Auto Clear screen to set auto clear, set the clear threshold weight, enable or disable motion check for auto clear, clear after print, clear when the scale is zeroed, and the power up setting. The options are:

Disabled [default], Enabled

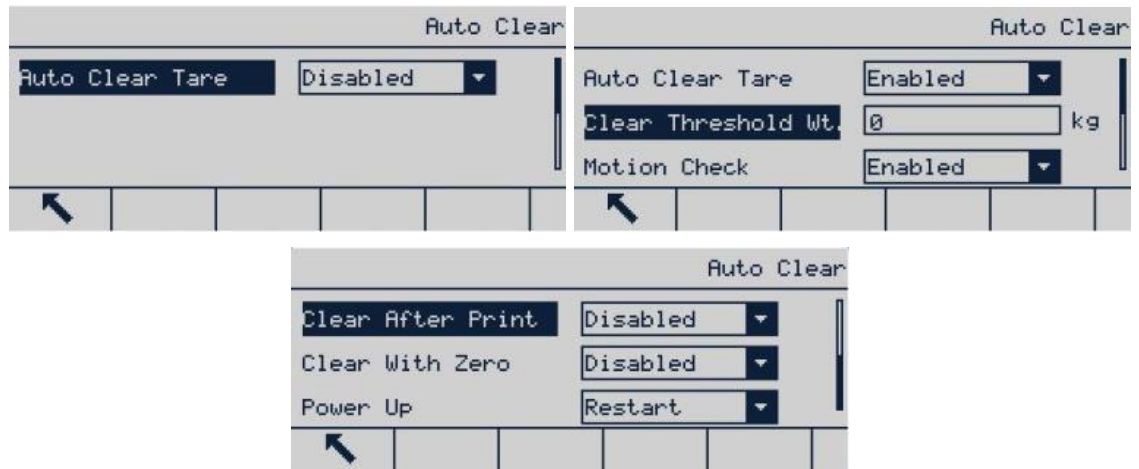

Figure 3-31: Auto Tare Screens

3.5.5.3.1. Auto Clear

When auto clear is enabled and the weight is below the auto clear threshold, the terminal will clear the tare automatically. The options are:

Disabled [default], Enabled

3.5.5.3.2. Clear Threshold Weight

Clear Threshold Weight will be displayed only when auto clear is enabled. When the gross weight on the scale exceeds and then falls to below the configured clear threshold weight, the terminal will clear automatically and return to gross weight mode.

3.5.5.3.3. Motion Check

The motion check field is displayed only when auto clear is enabled. The motion check is enabled to prevent auto clear of the scale in motion. Options are:

Disabled, Enabled [default]

3.5.5.3.4. Clear After Print

When Clear After Print is enabled, the tare is cleared after a print command is executed. Options are:

Disabled [default], Enabled

3.5.5.3.5. Clear with Zero

When Clear with Zero is enabled, tare is cleared when the zero point is captured from the net weight mode. Options are:

Disabled [default], Enabled

3.5.5.3.6. Power Up

The Restart power-up setting allows the terminal to use the most recently captured tare after the terminal is powered down and powered up again. If Reset is selected, the terminal returns to gross weight mode after power up and the last tare before power down is cleared. Options are:

Restart [default], Reset

3.5.6. Units

This screen allows a second unit to be selected, and determines the unit it uses at power up.



Figure 3-32: Units Screen

3.5.6.1. Second Unit

Use Second Unit selection box to select second weighing unit.

Available weighing units are:

- None
- kg
- oz
- ton
- g
- lb
- t

3.5.6.2.

Power up

The power up unit defines the default unit used by the terminal after power up.

- Primary Unit The terminal uses the primary unit after a restart.
- Restart [default] The terminal uses the unit last displayed before the terminal was powered down and powered up again.

3.5.7.

Filter

The IND256x uses low pass, notch and stability filters to ensure that the system provides the best weighing performance. Several conditions can be set. The heavier the filter, the longer it will take for the weight data to stabilize. When Remote is selected as the scale type, this screen cannot be accessed.

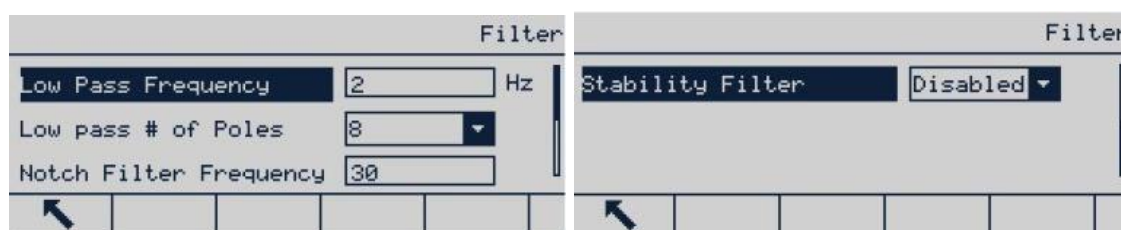

Figure 3-33: Filter Screens

3.5.7.1.

Low Pass Filter Frequency

A low pass frequency filters out all interference of a higher frequency. The lower the frequency, the better the interference suppression, but it will take the scale longer to stabilize. The range of possible values is 0.2 to 9.9.; however, values below 1.0 should not be used, because of the extremely long stabilization time required. The default value is 2.0 Hz.

3.5.7.2.

Low Pass Filter Number of Poles

The number of poles determines the filter cutoff slope. For most applications, the default slope value of 8 is acceptable; however, reducing this figure will slightly improve the stabilization time. Options are:

- 2, 4, 6, 8 [default]

3.5.7.3.

Notch Filter Frequency

The notch filter permits selection of a specific frequency that can be filtered which is higher than the low pass filter value. This allows the low pass to be set low to filter all frequencies other than the specific frequency handled by the notch filter, in order to obtain a fast stabilization time. The range of possible values is 0 (disabled) to 99, with 30 Hz the default.

3.5.7.4.

Stability Filter

The Stability filter works with the standard low pass filter to provide a steady final weight reading. The options are:

- Disabled [default], Enabled

- The Stability filter should only be used in basic weighing applications, because the nonlinear motion of the filter switch may result in inaccurate cutoff in batch or filling applications.
- The Stability filter can be combined with low pass filter to obtain a more stable weight.

3.5.8. Stability

The stability setup screen allows setting the motion range, motion check time and timeout period.

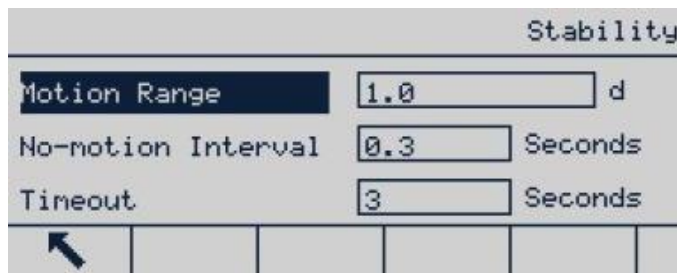

Figure 3-34: Stability Screen

3.5.8.1. Motion Range

Motion range is set in divisions. It sets the range within which the scale weight can fluctuate and be considered stable. When the weight change range is within the motion range, the terminal interprets the scale as stable. The range of possible values is 0.1 to 99.9, with 1.0 d the default.

3.5.8.2. No-Motion Interval

The No-motion interval defines the time period during which the scale must be stable (within the motion range defined in section 3.5.8.1) before weight will be captured. Possible values are 0.0 (motion check disabled) to 2.0, with 0.3s the default. A shorter time interval means that no-motion conditions are more easily attained, but the accuracy of the measured weight may decline.

3.5.8.3. Timeout

Define the period after which the terminal stops attempting to execute a function requiring a no-motion condition (such as zero, tare or a print command) and cancels the function.

The timeout is used regardless of the command source, such as keyboard, discrete input, PLC or SICS. The possible value range is 0 to 99, with 3s the default. The smaller the value, the less time the terminal will wait for stability before cancelling the command. When the timeout is set to zero, the scale must be stable or the command will be cancelled immediately. The value 99 is a special condition in which the terminal will wait indefinitely for a no-motion condition – the command will never be canceled.

3.5.9. MinWeigh (minimum weight)

Some industries require that the weighing equipment selected for specific measurements must be suitable for specific tasks. A method to ensure use of appropriate weighing equipment is to implement a minimum weight (MinWeigh) setting. The weighing system should not be used if measured loads are lower than the MinWeigh value.

If the net weight is greater than or equal to MinWeigh, all terminal functions can work normally. If the absolute value of the net weight is less than MinWeigh, the weight display will show a flashing MinWeigh symbol  in the left of the weight. If the user attempts to record the weight during this condition, the printed weight will contain an asterisk (*).



Figure 3-35: MinWeigh Screens

3.5.9.1. MinWeigh (minimum weight)

Select the operation modes of MinWeigh characteristic. The options are:

- Disabled** MinWeigh is not operative.
- Direct (Manual input)** MinWeigh is operative, and a MinWeigh value, in primary units, can be entered in the MinWeigh Value field.

3.5.10. Log or Print

The Log or Print screen is used to control the triggering of demand data outputs. The normal demand mode print will occur only when there is no motion on the scale and the weight is higher than the gross weight zero (negative gross weight will not be printed) regardless of the time of print request.

The entered weight value is a gross weight and the primary unit is selected. Gross weight in primary units is selected no matter whether IND256x is in gross weight mode or net weight mode, and regardless of which unit is displayed.

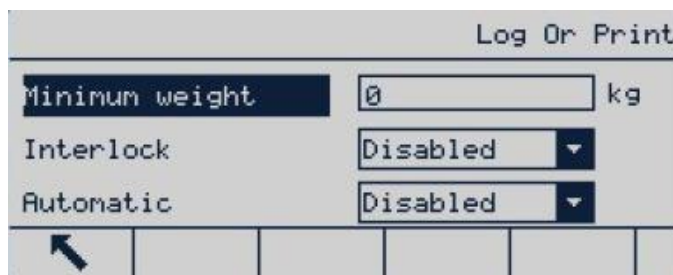

Figure 3-36: Log or Print Screen

3.5.10.1. Minimum Weight

The minimum weight setting is the threshold below which log or print functions will not initiate. A value of 0 permits printing when any weight value (unless the display is blanked for over capacity or under zero) is shown.

3.5.10.2. Interlock

Interlock prevents repeat logging and printing without a weight change. If Enabled, interlock requires that the weight reading be reset per the "Reset on" parameter setting (see below) and then settle to a weight greater than the minimum print value before responding to the next log or print request. If Disabled, multiple prints of the same weight are possible.

Disabled [default], Enabled

3.5.10.3. Automatic

Enable the automatic setting to automatically log data and print every time the weight on the scale settles to a positive value that is larger than the entered threshold weight value.

If Automatic is set to Disabled, the Threshold Weight field does not appear and a print or log of data must be triggered manually.

3.5.10.4. Reset On

The resetting of auto printing or logging can be based on weight threshold or weight deviation values. Select Return (the weight must return to below this value to reset) or Deviation (the weight must change more than this value to reset) from the selection box and enter the weight value in the "Reset on" field.

If both "Interlock" and "Automatic" settings are disabled, the "Reset on" field does not display.

If "Reset on" is set to Deviation, The "Threshold Weight" and "Motion Check" fields do not display.

3.5.10.5. Threshold Weight

The Threshold Weight is the value above which an Automatic logging or printing of data can/will occur. Threshold Weight does not appear if "Automatic" is set to Disabled or if "Reset on" is set to Deviation.

3.5.10.6. Motion Check

Enable the motion check setting to prevent interlock and automatic log and print functions from resetting when the scale is in motion below the "Reset On" return point. Motion Check does not appear if "Reset on" is set to Deviation.

3.5.11. **Reset**

The Reset screen allows resetting "Scale" branch set value to factory default setting.

To reset, press OK softkey . In case of reset success, a proof message appears, showing "Reset successful". In case of reset failed, an error message appears, showing "Reset failure". In case of reset failed, try to reset again. If continuing to fail, contact local Mettler-Toledo representative for help.

Press ESC softkey to exit without resetting.

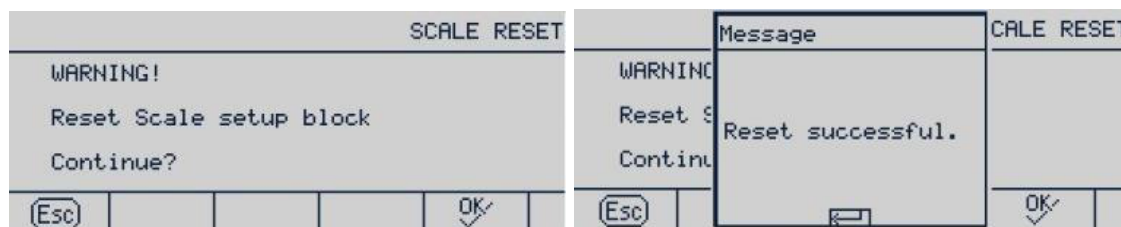

Figure 3-37: Reset Screens

- "Scale reset" does not reset setup parameters such as scale type, approval, primary unit, range, division value and scale calibration data. Such data can only be reset by executing a "Master reset". In this case, SW-1 and SW-2 switches must be set to ON.

3.6. Application

Use Application setup screen to configure the following setup parameters:



Figure 3-38: Application Menu

3.6.1. Memory

The set "memory" branch provides access to Alibi memory, tare table, ID and transaction log parameters.

3.6.1.1. Alibi

The Alibi memory stores basic transaction records and cannot be modified. Alibi memory is configured as "cycle" buffer; when the storage limit is reached, the earliest records will be covered. Alibi memory may save up to about 60,000 transaction records. Options are:

Disabled [default], Alibi memory

The Alibi memory stores separate transaction data for future retrieval. The data stored in Alibi memory includes:

- Transaction number
- Transaction date and time
- Gross weight, net weight and tare
- To clear all records in Alibi memory, it is required to disable Alibi memory first, exit Alibi setup screen, then enter again and set Alibi to Alibi memory.

3.6.1.1.1. View Alibi Memory Record

1. Enter the setup menu, select "Application" submenu, select memory and enter, select Alibi and then select Alibi memory from the option box.
2. Press VIEW TABLE softkey ; the Alibi Search screen appears.

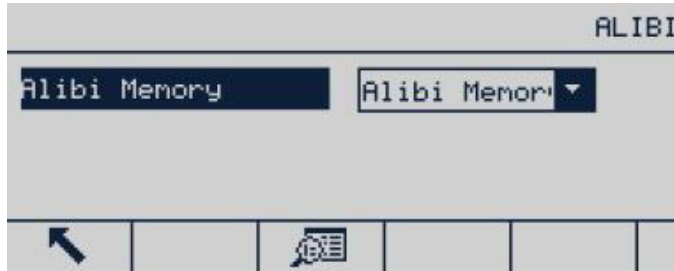



Figure 3-39: Alibi Menu

3. Use the selection box and relevant field and enter the specific search information for limited search without entering any search limit or *("Search all") to view all information. At most two search fields are provided.
4. Press START SEARCH softkey  and Alibi Search View screen appears with search results. The records are sorted by time and the earliest records are displayed first.
5. Press the mak/csv softkey to change the format of Alibi log file to .csv
6. Press the up, down, left and right navigation keys, to scroll the screen and view all available data and records.

Date	Time	Transaction	N
27-Apr-2018	14:44:32	00000007	15.56
27-Apr-2018	14:44:38	00000008	26.48
27-Apr-2018	14:44:54	00000009	1.76



Figure 3-40: Alibi Screen

3.6.1.1.2. Print Alibi Memory Record

1. Ensure that the same COM port (access Communications > Connections) is assigned for both Reports and Demand Output.

Port	Assignment	Trigger
COM1	Reports	
COM1	Demand Output	Scale

Figure 3-41: Connections List

2. Access the Alibi Memory screen (at Application > Memory > Alibi > Alibi Memory) and press the VIEW TABLE softkey . Then click the PRINT softkey .

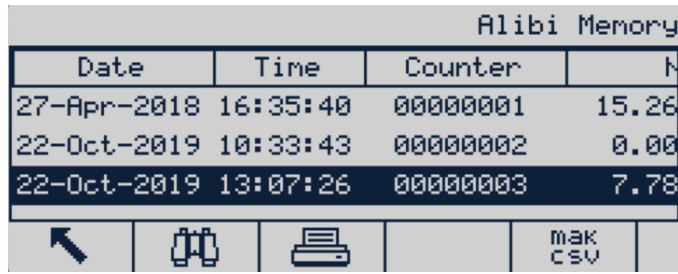

Alibi Memory			
Date	Time	Counter	N
27-Apr-2018	16:35:40	00000001	15.26
22-Oct-2019	10:33:43	00000002	0.00
22-Oct-2019	13:07:26	00000003	7.78

Figure 3-42: Alibi Memory View

3. The IND256x will prompt Print this one Record? Click Yes to start printing, or No to cancel the print. Then the terminal will prompt Print all Records? Click Yes to start printing the entire Alibi Memory record table, or No to cancel the print. Press the EXIT softkey  to leave the Alibi Memory Record screen.

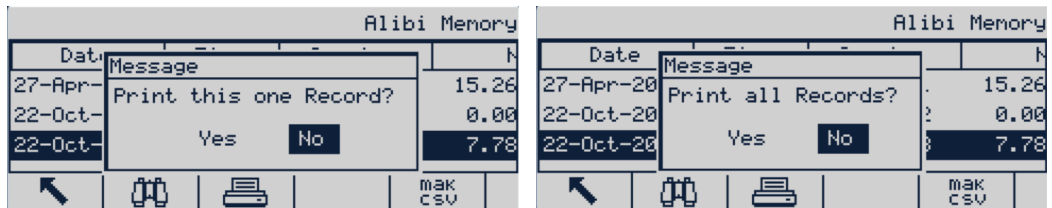



Figure 3-43: Alibi Memory Record Printing

3.6.1.2. Tare Table

The Tare table displays the stored tare records, including ID, description, tare value, unit and quantity of the transactions that have used tare as well as cumulative weight of all transactions using tare ID.

Use the Tare table setup screen to enable or disable description and configure accumulation. Press CLEAR softkey  to reset this table.

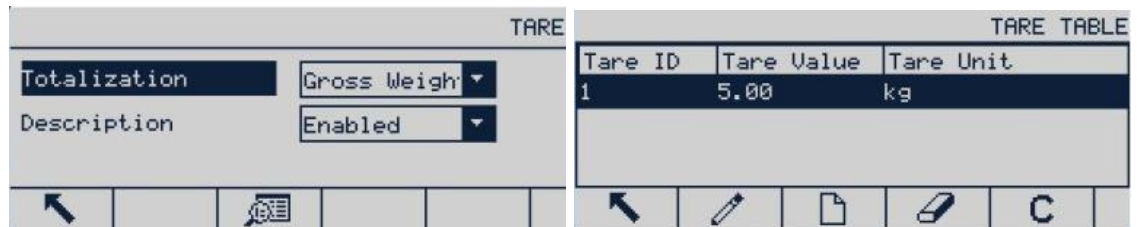



Figure 3-44: Tare Table Screens

- Depending on which columns are enabled in the tare table, it may be necessary to scroll right (using the RIGHT  navigation key) to view further columns.

3.6.1.2.1. Description

The "Description" is an alphanumeric string used to describe each tare table entry. Use the "Description" selection box to enable or disable "Description" in the tare table structure. Options are:

Disabled [default], Enabled

3.6.1.2.2. Totalization

Totalization is a field tracking the total weight of all transactions involved in each tare in the table. The possible options are:

None [default], display weight, gross weight

3.6.1.2.3. Tare Table Record







Depending on the configuration of the tare table, a record may include some or all of the following fields:

Tare ID	Identification number of activation record
Tare Desc	Narrative identification of activation record
Tare Value	Expected preset tare value
Tare unit	Unit of measurement of tare (tare record unit may be any available primary unit)
Tare Total Cnt	Number of transactions using tare records
Tare Total Wgt	Cumulative weight of all transactions using tare ID

View Tare Table Record

1. Press the VIEW TABLE  softkey. The Tare Search screen will display all records with a weight higher than the tare value. The records are sorted by ID, with the lowest ID number displayed first.
2. Press up, down, left and right navigation keys, up and down and across screen rolling to view all data and records listed.



Change or Add Tare Table Record



1. Press the up and down navigation keys to select the record in the (highlight) table.
2. Press the EDIT softkey  and open the setup screen used to edit record; or press the NEW softkey  and open the setup screen used to create new table record.
3. Press up and down navigation keys and move the cursor to the field name to be edited or inserted.
4. Press ENTER to select the field value to be edited or inserted and the letter keys appear.
5. Use the letter keys and numeric keyboard to edit or enter the expected value.
6. When the tare input field is highlighted, press ENTER to edit or enter the expected value.
7. Press the OK softkey  to accept change or addition of "tare table".
8. Press the EXIT softkey  to return to Tare Search View screen without saving change or add.
9. Press the DELETE softkey  to delete the tare record in the list.
10. Press the CLEAR softkey  to reset this table.

11. Press the PRINT softkey  to print the table if Report function is assigned to the communication port.

12. Press the EXIT softkey  to return to Tare Search screen.

3.6.1.3. ID

Press the ID softkey and enter three ID values: ID1, ID2 and ID3 in ID input interface. Press the START SEARCH softkey  to view or delete ID1, ID2 and ID3. Press EDIT  to edit ID value. The title will accept a maximum of 10 characters, and the description as many as 20.

Once the parameters have been set in ID edit screen, they can be saved by Enter  or cleared by pressing EXIT . In either case, the display returns to ID view screen.



For details on how to enter data, refer to section 2.3 in chapter 2, Operation.

3.6.1.3.1. Import ID Values to IND256x

There are two ways to import ID values to IND256x:

- Using the SD card installed on the Main PCB
- Via the FTT (File Transfer File) provided with IND256x.

Import ID Values Directly to IND256x SD Card

	 WARNING
	<p>DO NOT OPEN THE TERMINAL WHEN THE ATMOSPHERE IS EXPLOSIVE DUE TO DUST. TO PREVENT IGNITION OF HAZARDOUS ATMOSPHERES, DISCONNECT THE IND256X FROM ITS POWER SOURCE BEFORE OPENING THE ENCLOSURE. KEEP COVER TIGHTLY CLOSED WHILE THE CIRCUIT IS ENERGIZED. DO NOT OPEN WHEN AN EXPLOSIVE DUST ATMOSPHERE IS PRESENT.</p>

1. Prepare separate ID files for ID1, ID2 and ID3 in a PC.

- Note that these ID files should contain both ID index and ID descriptions; are named ID1, ID2 and ID3; and are saved in .csv format.

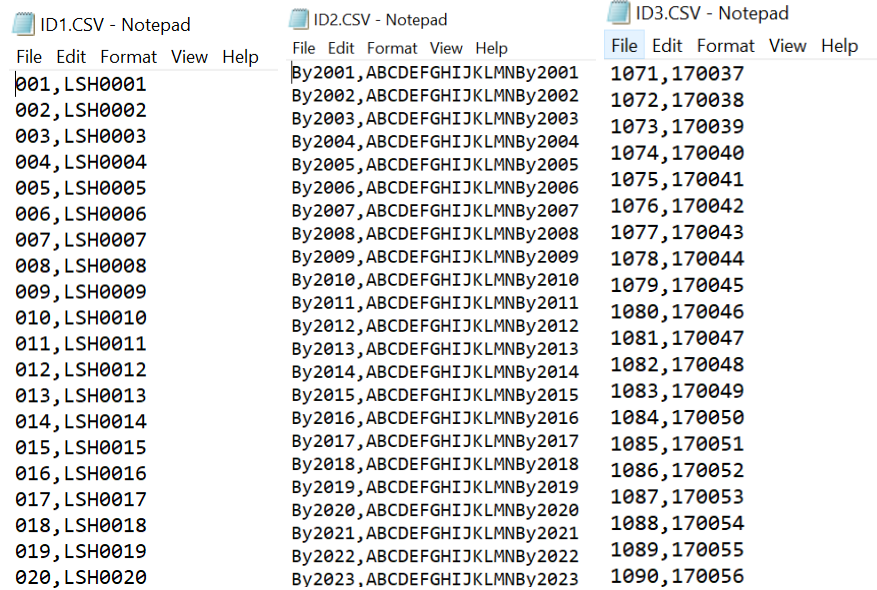

Figure 3-45: Sample ID Value Files

2. Turn off the IND256x and open its enclosure.
3. Remove the SD card from its slot on the main PCB.

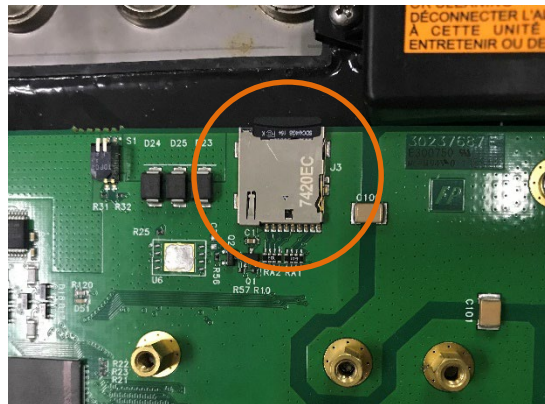

Figure 3-46: IND256x SD Card Location

4. Connect the SD card to the PC.
5. Copy the ID files from the PC, and save them to the root directory of the SD card.
6. Insert the SD card into its slot on the main PCB, and close the enclosure.
7. Turn the IND256x on.
8. Now, in the ID Input screen, when an index value is entered for ID1, ID2 or ID3, the corresponding ID description will appear automatically.

ID Input		
ID1	011	LSH0011
ID2	By2012	ABCDEFGHIJKLMNBy2012
ID3	1087	170053

Figure 3-47: ID Input Screen

Import ID Values to IND256x via FTT (File Transfer Tool)

1. Prepare separate ID files for ID1, ID2 and ID3 in a PC.
 - Note that these ID files should contain both ID index and ID descriptions; are named ID1, ID2 and ID3; and are saved in .csv format, as shown in Figure 3-45.
2. Connect the IND256x to the FTT (File Transfer Tool), referring to the FTT Technical Manual (included on in the documentation CD provided with IND256x).
3. In the FTT, click Write to Terminal.

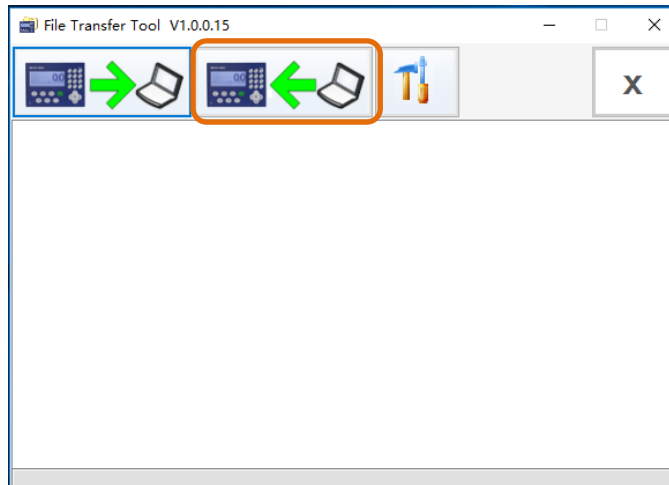

Figure 3-48: FTT – Write to Terminal Button

4. Select the target ID file from the File Selection dropdown list. Use Change to choose the corresponding file path of the selected ID file.

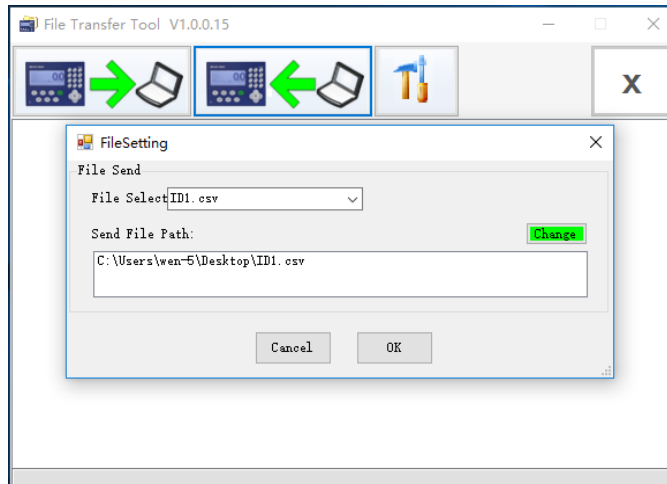

Figure 3-49: FTT – Selecting the ID File Path

5. Click OK. The following message appears to indicate that the import was successful.

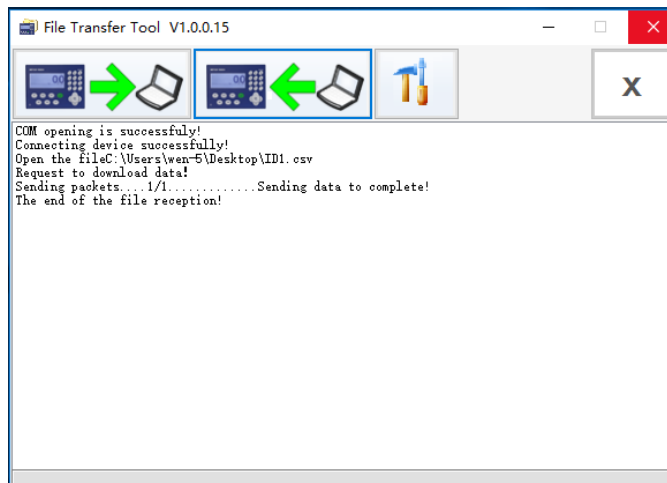

Figure 3-50: FTT – Confirmation of File Transfer Success

6. Repeat steps 2 to 4 to import the remaining two ID files to the terminal.
7. Now, in the ID Input screen, when an index value is entered for ID1, ID2 or ID3, the corresponding ID description will appear automatically (see Figure 3-47).

3.6.1.4. Transaction Log

Transaction log field options are Trans. Table Config. and Trans. Table Search.

3.6.1.4.1. Transaction log Configuration

By default the transaction log records contain:

- Transaction No.
- Transaction date and time
- Gross weight, net weight and tare

Up to four additional items can be recorded by selecting an item number from 1 to 4 from the first drop-down list, then selecting an item from the second drop-down list.

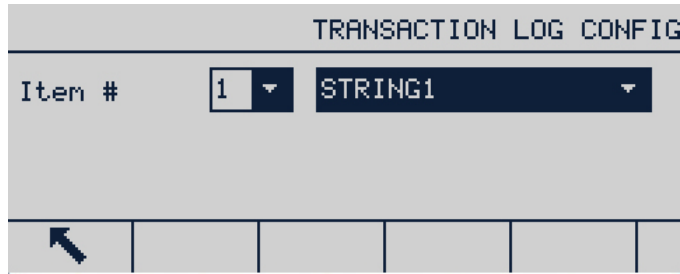

Figure 3-51: Transaction Log Configuration Screen

The following items are available for inclusion:

None (default)	TARGET+
SCALENA.	Result
TRANSDSC	STRINGx (x = 1,2,3)
TARGETVAL	IDx (x = 1,2,3) INDEX
TARGET-	IDx (x = 1,2,3) DESC

- Changing the transaction log configuration resets the table.

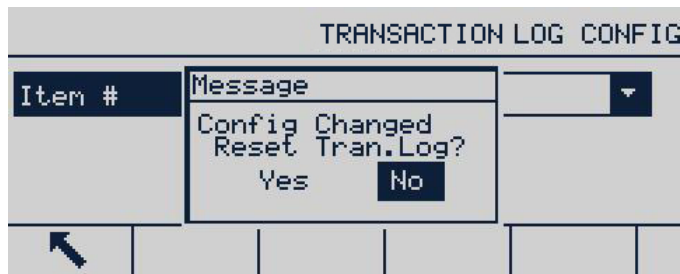



Figure 3-52: Transaction Log Reset Screen

3.6.1.4.2. Transaction Log Search

The table search screen includes selection boxes and associated fields to enter specific search information to limit the search. Alternatively, enter no search limits to view all Transaction log records. The displayed table view can be printed by clicking the PRINT  softkey.

3.6.1.4.3. Print Transaction Log Record

1. Ensure that the same COM port (access Communications > Connections) is assigned for both Reports and Demand Output.

CONNECTIONS		
Port	Assignment	Trigger
COM1	Reports	
COM1	Demand Output	Scale

Figure 3-53: Connections List

2. Access the Transaction Log Record (at Application > Memory > Transaction Log > Transaction Log Search) and press the START SEARCH softkey . Then click the PRINT softkey .

Transaction Log Record			
Date	Time	Counter	N
22-Oct-2019	10:33:43	00000002	0.00
22-Oct-2019	13:07:26	00000003	7.78

Figure 3-54: Transaction Log Record View

3. The IND256x will prompt Print this one Record? Click Yes to start printing, or No to cancel the print. Then the terminal will prompt Print all Records? Click Yes to start printing the entire Transaction Log record table, or No to cancel the print. Press the EXIT softkey to leave the Transaction Log Record screen.

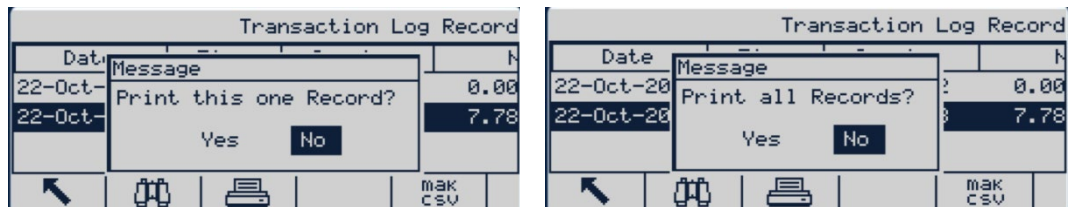

Figure 3-55: Printing Transaction Log Records

3.6.2. Application Assignment

Options for Application Assignment are:

Basic weighing [default], Checkweighing

Application		APPLICATION ASSIGNMENT	
Memory	APP Assignment	APP Assignment	Checkweighing
Checkweighing	Totalization		
Transaction Counter Reset			

Figure 3-56: Application Configuration

3.6.2.1. Checkweighing

When checkweighing is selected, the checkweighing options – Operation, Display and Target Table – will be displayed in the application screen.



Figure 3-57: Checkweighing Application Configuration Menu

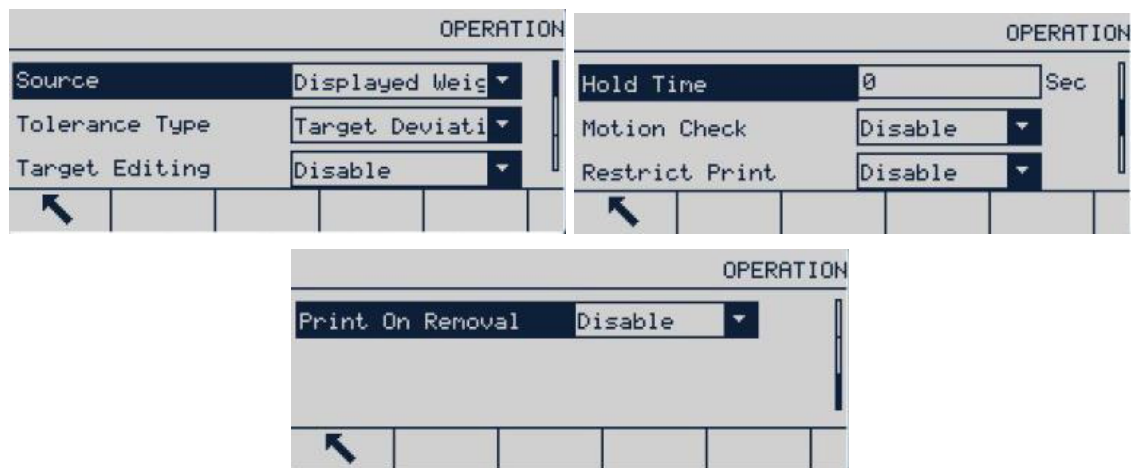

Figure 3-58: Checkweighing Application Operation Screens

3.6.2.1.1. Operation

Source

The data source can be set to Displayed Weight (default) or Gross Weight. If Displayed Weight is selected, the checkweighing function is based on displayed weight.

If Gross Weight is selected, the target value is based on gross weight even if the terminal has tared or is in net weight mode.

Tolerance Type

Tolerance type includes target deviation (default), % of target and weight value. The tolerance type setting determines the basis on which the terminal compares upper and lower limits of checkweighing.

Target Editing

The target value edit parameter determines which parameters may be accessed and modified from the operator's screen. The options are:

Disabled [default], target only, target & tolerance

When the target only or target & tolerance is selected, the operator can edit the value/s. All data can be edited in setup.

Hold Time

The hold time range is 0-9s. If the terminal receives a print command after setting, the screen will remain unchanged for the defined period. If the terminal receives a print command, the screen will count from 0 until the lock screen time, after which the screen will display the current, real-time weight.

During the hold time, an asterisk appears on the screen (*) to indicate that the displayed weight is not the live weight on the scale.

Motion Check

The Motion check parameter can be disabled (default) or enabled. When it is enabled, the discrete output of Under, Ok, Over will be enabled and the weight state identifier will be displayed only when the weight on the scale is stable. When disabled, the above output and display will be enabled as long as the weight is with the defined range, whether or not the weight is stable.

Restrict Print

Print restriction options are:

Disabled [default], Enabled.

3.6.2.1.2. Display

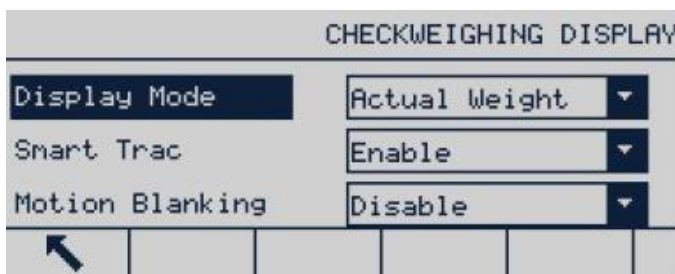

Figure 3-59: Checkweighing Application Display Screen

Display Mode

Display mode determines the display content – actual weight (default), target deviation or no-display in the main display area.

Smart Trac

Smart Trac options are:

Disabled, Enabled [default]

SmartTrac is a graphic visualization of the weight on the scale, when it is enabled, it may be viewed in the main screen.

Motion Blanking

The options are:

Disabled [default], Enabled

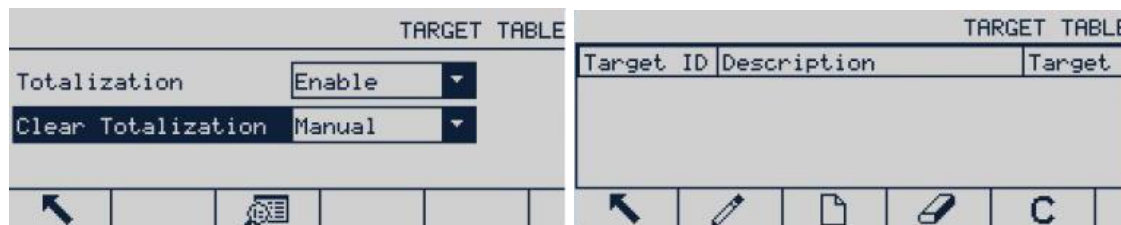

Figure 3-60: Checkweighing Application Target Value Table Screens

3.6.2.1.3. Target Table

Totalization in Target Table

The options are:

Disabled [default], Enabled.

When totalization is enabled, the Clear Totalization parameter will display.

Clear Totalization

The options are:

Automatic, Manual [default], Disabled

3.6.3. Totalization

Set totalization related parameters under the totalization setup interface. The options are:

None [default], Displayed Weight, Gross Weight



Figure 3-61: Cumulative Screen

3.6.3.1. Mode

The Mode setting determines which data is totalized – displayed weight or gross weight. The totalization function is disabled if none is selected.

3.6.3.2. Clear GT (Grand Total) on Print

When Clear GT on Print is enabled, the total value is cleared when the total report is printed. If enabled, the subtotal will be cleared automatically after printing the total reports.

3.6.3.3. Subtotal

Choose to enable or disable the subtotal register.

3.6.3.4. Clear ST (Subtotal) After Print

When Clear GT on Print is enabled, and Clear ST on Print is enabled, the terminal continues to accumulate the total, and resets the subtotal register when the total is printed. Select enable or disable in the selection box.

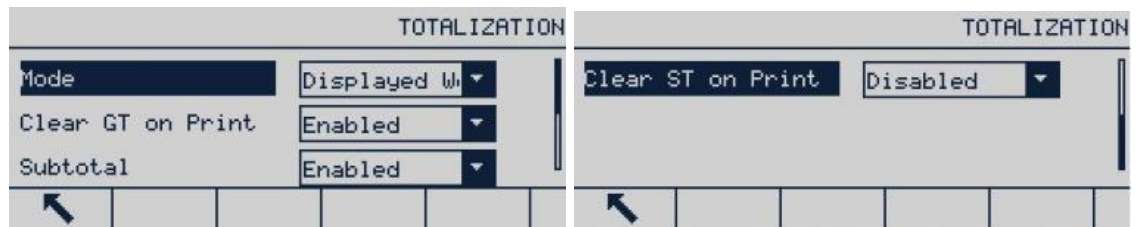

Figure 3-62: Totalization Screens

3.6.4. Transaction Counter

This screen displays the following items:

- Transaction counter
- Counter reset
- Next transaction

The transaction counter may be Enabled [default] or disabled to record the transaction data.

The Counter Reset parameter enables resetting the count using the Transaction Counter **123** softkey, configured in setup at Terminal > Softkeys (refer to section 3.7.5.)



Figure 3-63: Transaction Counter Configuration Screen

3.6.5. Reset

The reset function returns most configuration settings in the application branches to their original factory default values.

To reset, press OK softkey . In case of reset success, a proof message appears, showing "Reset success". In case of reset failed, an error message appears, showing "Reset failed". In case of reset failure, try to reset again. If the process continues to fail, contact your local METTLER TOLEDO representative for assistance.

Press Exit softkey  to exit without resetting.

- Application > Reset does not reset the information stored in the Alibi memory or table. Such data may only be reset by executing the function found in Maintenance > Reset All.

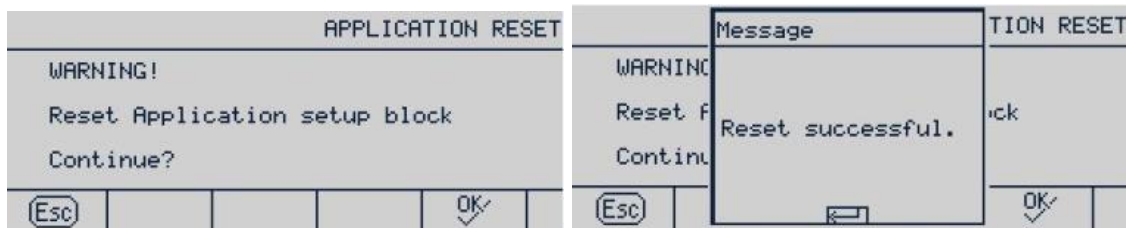

Figure 3-64: Application Reset Screens

3.7. Terminal

The following parameters may be set in the terminal menu:

- Device
- Users
- Display
- Softkeys
- Region
- Reset

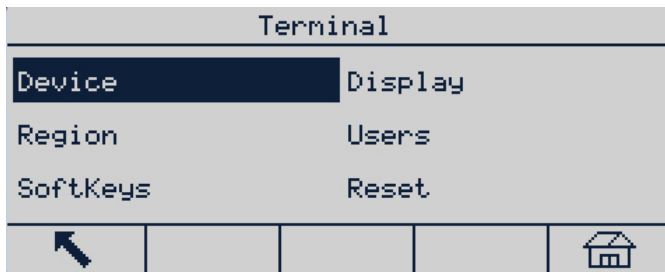

Figure 3-65: Terminal Menu

3.7.1. Device

The Device setup screen allows displaying the terminal serial number information, battery type and service contact.

3.7.1.1. Serial Number

The Serial Number textbox is used to enter the serial number of IND256x terminal.

3.7.1.2. Battery Type

Two battery types are available. These are:

None [default], Li, NiMH

Li: Explosion-proof lithium battery sold in Chinese mainland market (only with China explosion-proof certification)

NiMH: Explosion-proof NI-MH battery sold in global market (with global explosion-proof certification)

3.7.2. Display

Use the Display setup screen to configure the settings for backlight timeout, auto OFF, system line contents, backlight level and tare display.

3.7.2.1. Backlight Timeout

Backlight timeout may save electric energy is particularly useful for DC power supply. When the terminal is steady without key action in the setup time, the backlight is off automatically. The options are:

Always On, Disabled, 1min, 5min [default], 10min.

3.7.2.2. Auto OFF Timer

This feature helps conserve battery power by putting the terminal into a sleep mode by turning off the display after a certain amount of time has passed with no-motion and no key presses. If a key is pressed or the motion is detected on the scale, the terminal will wake up automatically. The options are

disabled [default], 10min, 30min and 60min.

3.7.2.3. System Line

The system line in the weighing display can be configured to display the time and date. The options are Blank, Time and Date [default].

3.7.2.4. Backlight Level

The outdoor sunlight may affect the terminal display effect. The display effect may be adjusted through contrast control. The backlight level options are:

High, Mid [default], Low

The backlight level may also be adjusted at will by pressing  soffkey and up and down navigation keys.

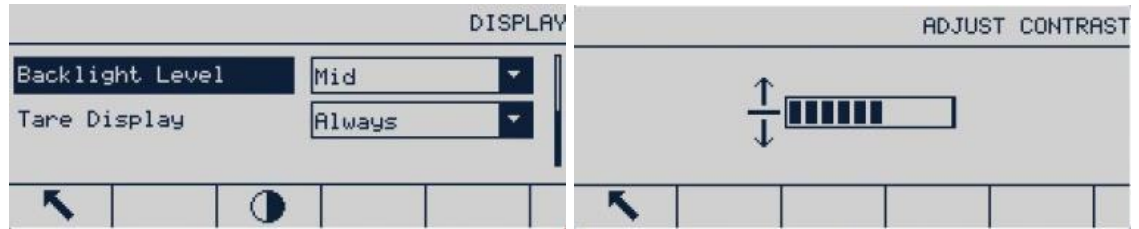

Figure 3-66: Backlight Level Adjustment Screens

3.7.2.5. Tare Display

This setting determines whether the tare is displayed on the main screen when the weight screen of the largest size is displayed. The tare display options are:

- | | |
|------------------|---|
| Never | The tare value will not appear in the weight display |
| Tare Activated | Only when the tare has been available, the tare value will appear on the weighing main interface. The tare value is not displayed in gross weight mode. |
| Always [default] | A space is reserved in the weighing main interface for current tare value. The tare is displayed as 0 in gross weight mode. |

3.7.3. Region

Configure the following settings in the region screen:

- Time and date format
- Time and date setting
- Language

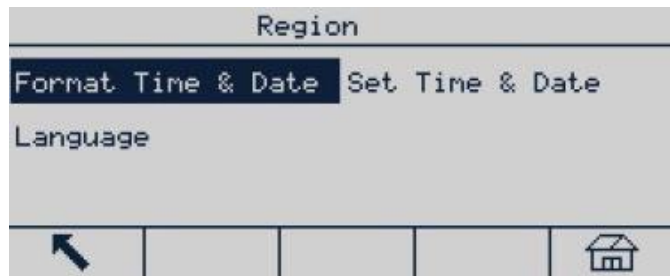

Figure 3-67: Country/Region Menu

3.7.3.1. Time & Date Format



Figure 3-68: Time & Date Format Screen

3.7.3.1.1. Time Format

- 12:MM (12h format, MM indicates minute)
- 12:MM:SS (12h format, MM indicates minute and SS indicate second)
- 24:MM (24h format, MM indicates minute)
- 24:MM:SS[default] (24h format, MM indicates minute and SS indicate second)

3.7.3.1.2. Date Format

- DD/MM/YY (day, month, year)
- DD/MMM/YYYY[default] (2-bit indicates day, 3-bit month and 4-bit year)
- MM/DD/YY (month, day, year)
- MMM/DD/YYYY (3-bit indicates month, 2-bit day and 4-bit year)
- YY/MM/DD (year, month, day)
- YYYY/MMM/DD (4-bit indicates year, 3-bit month and 2-bit day)
- YYYY/MM/DD (4-bit indicates year, 3-bit month and 2-bit day)

3.7.3.1.3. Separators in Date Format

- / [default] (oblique line)
- - (dash)
- . (full stop)
- (Spacing)
- None (none)

3.7.3.2. Set Time & Date

Enter the hour, minutes, day, month and year in the text fields and selection box of this setup screen. The terminal will automatically adjust the date in a leap year. In case of power failure, the standby battery will maintain the time and date setting.

- When required, a daylight saving time adjustment must be made manually.

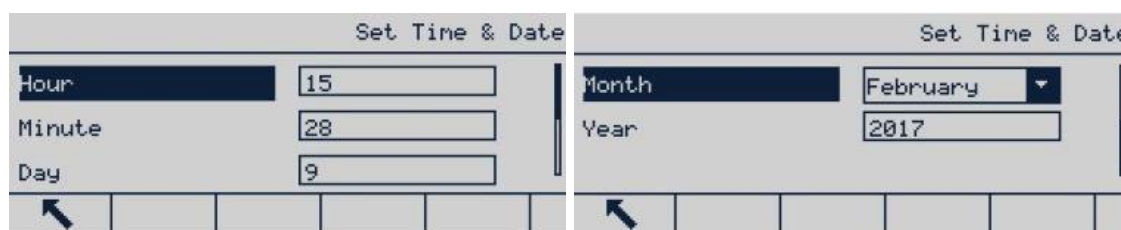

Figure 3-69: Time and Date Setting Screens

3.7.3.2.1. Hour

Use numeric keyboard to enter hour in Hour field textbox. If the time format is set to 12:MM or 12:MM:SS in the format date and time setting, AM [default] or PM must be selected.

- 3.7.3.2.2. Minutes
Use numeric keyboard to enter minutes in Minutes field textbox.
- 3.7.3.2.3. Day
Use numeric keyboard to enter day in Day field textbox.
- 3.7.3.2.4. Month
Use Month selection box to select month.
- 3.7.3.2.5. Year
Use numeric keyboard to enter year in Year field textbox.
- 3.7.3.3. Language
Use the Language setup screen to set the terminal language.



Figure 3-70: Language Selection Screen

Use Display Messages selection box to select the language of the messages displayed in the terminal. Options are:

English [default], Spanish, German, French, Italian, Portuguese, Chinese, Polish

3.7.4. Users

The password function is disabled when the IND256x terminal is delivered. The user can enable, enter and confirm a password, and press Enter to save.





Figure 3-71: Users Screen

- 3.7.4.1. Enter Password
 1. Enter the desired password in "Password" and "Confirm Password".
 2. Press Enter  to accept the entered user name and password.

3. Press Exit  to exit without saving the user name or password.

3.7.4.2.

Change and Delete Password

1. Move the cursor to the password to be edited.
 2. Enter the desired password and press Enter  to save.
 3. Press Exit  to exit without saving the password.
- Empty the password in the password box and press Enter to save to delete the password.

3.7.5. Softkeys

Set the shortcut keys on the weighing main interface by configuring "Softkeys".

Adding softkeys to the weighing main interface of the terminal does not mean that the functions the softkey references are automatically enabled. Most functions related to the softkey must also be enabled in setting. For example, adding UNITS SWITCHING softkey  does not allow units switching if second or third units are not set at Scale > Units. If a softkey has been added in setup, but does not appear on the home page, check whether the setup parameter of the function itself has been enabled.

- If a whole row of softkeys is blank, that row will not be displayed in the main screen. For example, if the softkey positions 1-5 and 11-15 are configured with softkeys, but positions 6-10 are blank, the second row of softkeys will not be accessible from the main screen.

The following softkeys can be configured for use on the home screen:

Softkey	View information*	Unit conversion
x10 display	Alibi	Transaction log
Report	Time date	Repeat print
Tare table	Tare table view	Contrast control
MinWeigh	Transaction count	Target value
Target value view	Cumulative report	ID

When the softkey edit screen is accessed, focus is located at softkey position 1, above the first icon.



Figure 3-72: Softkey Edit Screen

To edit a soffkey:

1. Use up and down navigation keys to select the software position number.
2. Press ENTER to select the soffkey selection box.
3. Use up and down navigation keys to scroll through the options until the cursor is located at the desired soffkey.
4. Press ENTER to select soffkey. If None is selected for distribution, the soffkey distribution is reserved as vacancy.
- At most 15 soffkeys can be defined.
5. Press EXIT soffkey  to return to the soffkey setup screen. The new soffkey will be displayed on the soffkey setup screen, and will appear on the home screen.

3.7.6. Reset

The "Reset" screen permits the resets the Terminal configuration to its factory default.

To reset, press the OK soffkey . A warning screen appears.

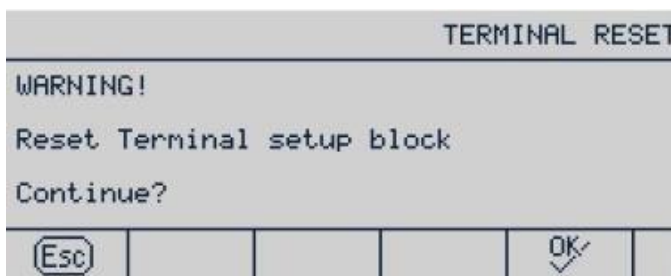

Figure 3-73: Terminal Reset Menu Warning Screen

When reset is successful, a prompt appears showing "Reset success". If the reset fails, an error message appears, showing "Reset failed". In this case, re-try the process. If reset continues to fail, contact your local METTLER TOLEDO representative for assistance.

Press the ESCAPE soffkey  to exit without resetting.

3.8. Communication

Configuration of following functions is managed from the Communication screen.

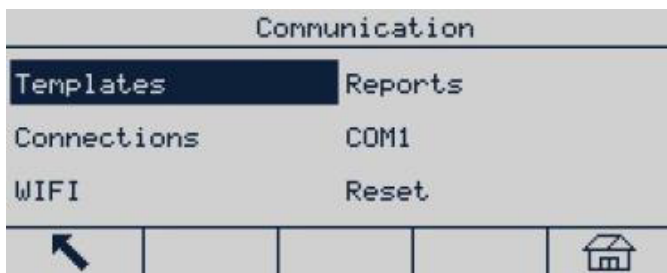

Figure 3-74: Communication Menu

3.8.1. Templates

The following template options may be configured:

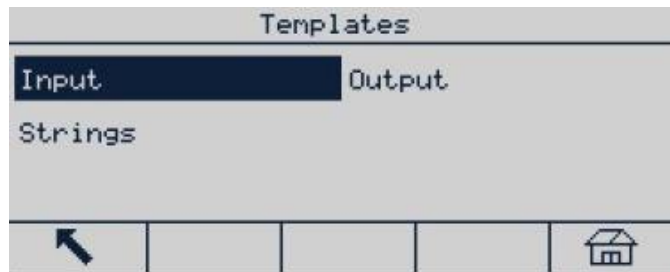

Figure 3-75: Communication Templates Menu

3.8.1.1. Input

Use the Input template to enter the device (such as barcode) and set the data format, to identify the specific data required for the source. The Input template setting parameters include the following:



Figure 3-76: Input Template Screens

3.8.1.1.1. Preamble Length

This how many characters are skipped at the beginning of an input string before the desired data is identified. Values from 0 to 255 can be entered.

3.8.1.1.2. Data Length

This defines the length of the data to be extracted from the incoming string. All characters beginning after the preamble through the data length selection are used as the input. Values from 1 to 40 are accepted.

3.8.1.1.3. Postamble Length

Defines the number of characters (before but not including the termination character) that will be stripped off the end of the incoming data string. When using an input that is always the same fixed length, this field remains blank. Values from 0 to 255 are accepted.

All characters after the preamble length to the termination character minus the postamble length are used as the input data string.

3.8.1.1.4. Termination Character

This is used to signal the end of the string input. The termination character can be any ASCII control character. Selections for Termination Character include:

EOT BS FF DLE DC4 CAN FS SOH

ENQ	HT	CR [default]	DC1	NAK	EM	GS	STX
ACK	LF	SO	DC2	SYN	SUB	RS	ETX
BEL	VT	SI	DC3	ETB	ESC	US	

- If None is selected, the entry is terminated after a three-second timeout. There is also a three-second timeout feature that tracks the amount of time between incoming characters. Even if a terminal character is selected, if three seconds elapses between character receipt, the string is considered terminated.

3.8.1.1.5. Assignment

This parameter determines how the input data should be used. Choices are:

Keypad	Data that would normally be entered using the alphanumeric keypad may be scanned in with this setting
Tare [default]	Enters input data as a preset tare value
Tare ID	Use incoming value as ID lookup in the tare table
Target ID	Use incoming value as ID lookup in the target value table

3.8.1.2. Output

The terminal supports 5 output templates, which may be set individually. Output template 1 is shown as an example in the illustration below.

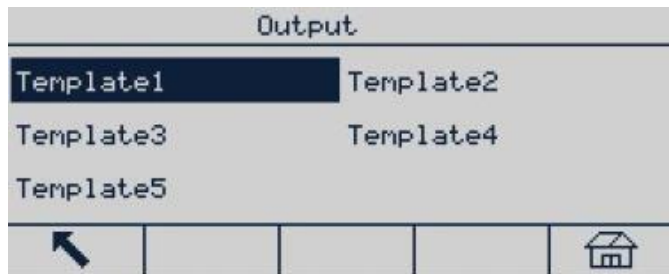

Figure 3-77: Output Template Menu

3.8.1.2.1. Output Template 1

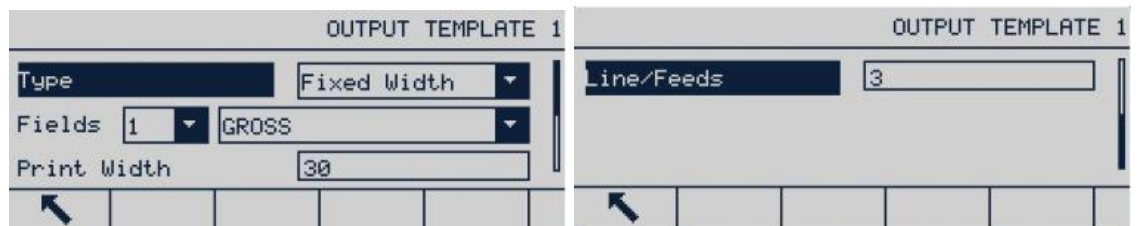

Figure 3-78: Output Template Configuration Screens

If the selected template is a custom label template created externally, set Type to Label Print. For further details on using a custom label template, refer to Appendix B, Communications, section B.7.4.

3.8.1.3. Template strings

The Template Strings setup screen defines strings frequently used in the output template message. Template strings may be viewed, edited, deleted or printed.

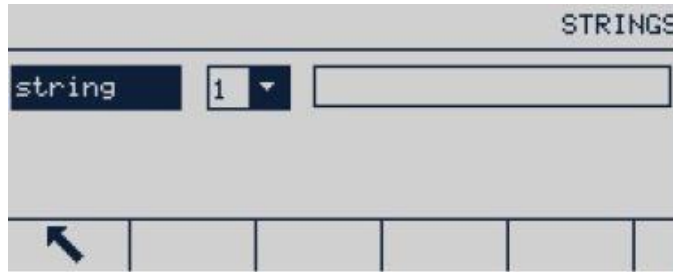





Figure 3-79: Template Strings Screen

3.8.1.3.1. Edit

1. When the focus is on the string label, press OK . Focus will move to the serial number drop-down box.
2. Press Up or Down to select the string serial number to be viewed, then press OK again. The focus moves to the edit field, where the string corresponding to the serial number is displayed.
3. Press the EDIT softkey  to open the record for editing. The edit screen will appear and the Text field is in focus. This is the only editable field in the screen. ID numbers cannot be changed.
4. Use the alphanumeric keyboard to edit the string. A string may contain up to 20 characters.
5. After input, press ENTER to save the new string. Press Exit  to return to String Search View screen, and the string change is not allowed.

3.8.1.4. Print Configuration

3.8.1.4.1. Title Configuration

Select the language used by the templates. Options are

English [default], Chinese, None

3.8.1.4.2. Printer

Select the type of printer connected. Options are

Others [default], PQ16

3.8.2. Reports

The Reports setup screen sets the structure of the tare table and target value table reports generated by the IND256x terminal.

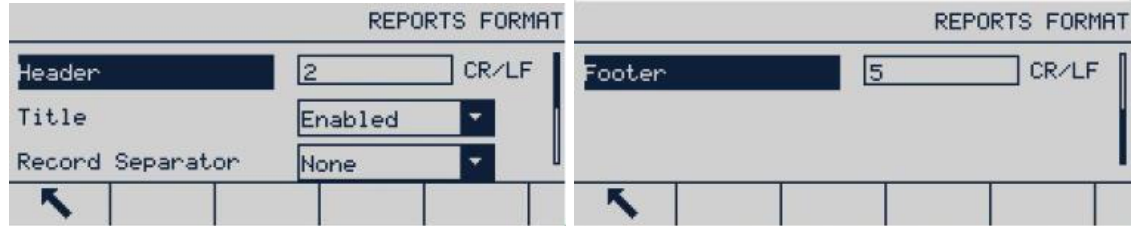

Figure 3-80: Reports Format Screens

3.8.2.1. Header

Header field specifies the number of blank lines (CR/LF) to be placed at the beginning of each report. Values from 0 to 99 are accepted, with 2 the default.

3.8.2.2. Title

The Title selection box allows a default title line to be printed at the top of the report. Options are:

Disabled, Enabled [default]

3.8.2.3. Record Separator

The report character may be selected as the separator between the print records in the report. The character to be used is selected at this step. The optional characters in the selection box include:

None [default], * (asterisk), – (dash), = (equal sign), CR/FL (blank line)

For example, if * (asterisk) is selected, the line separator will be displayed as follows:

3.8.2.4. Footer

Footer field stipulates the number of blank lines (CR/LF) to be placed at the end of each report. Values 0-99 are acceptable, with 5 the default.

3.8.3. Connections

The Connections setup screen displays the physical port connections configured in the terminal, including COM1 intrinsically safe RS232, WiFi option board and an active current loop option board. Each port is available only when the corresponding option board is installed.

The Connections screen lists what type of communication will occur over each programmed port. If no connection is programmed, no data transfer will be available over that port.

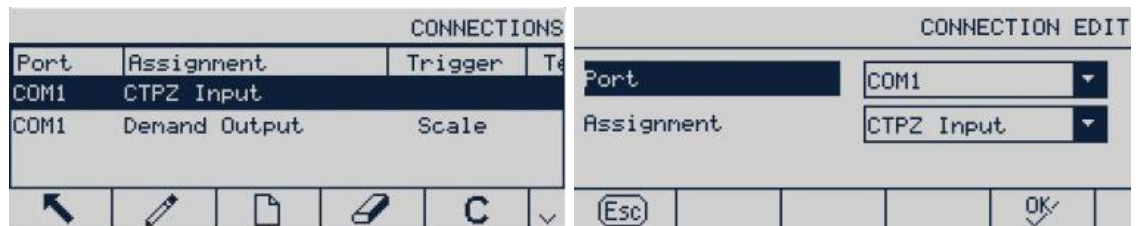



Figure 3-81: Connections Screens



3.8.3.1. Create and Edit Connection Allocation

1. Press NEW  to create new connection allocation; or press up and down navigation keys, select (Highlighted) edited connection allocation in the list and then press EDIT softkey  to open the setup screen for editing.
2. The parameters configured in Connections screen include input or output allocation port and type and the template to be sent.
3. Use the selection box of each field and select the port and allocation on connections.

The optional ports include COM1, COM2 and COM3

The allocation options support CTPZ input, command print, Shared Data service, report, SICS, remote display, character input, continuous output and EX200 continuous output.



Notes for connection options

- Not all options may be used for connection allocation. Only effective options may be displayed in the selection box.
 - Shared Data Server allocation may only be used in COM1. The serial connection to Shared Data Server can only be made using COM1. This allocation allows user to connect to the Shared Data Server in COM1, and does not require turning switch SW2-1 to "on".
 - Template field may be displayed only when the allocation option is "command output" or "continuous template". Only one template may be allocated for each connection.
 - SICS option provides level 0 and level 1 interface commands. Refer to Appendix B, Communication, for the details of SICS protocol.
 - The alarm message is displayed in case of use conflict.
4. When connection allocation is fully edited or added, press OK  to accept the connection parameter and return to the connection setup screen.
 5. Press ESCAPE softkey  to give up connection parameter and return to the connection setup screen without saving connection allocation edit or addition.
 6. Press EXIT softkey  to return to the menu tree.

3.8.3.1.1. Delete Connection

Use the UP and DOWN navigation keys to highlight the stored connection. Press the DELETE softkey  to delete the selected connection from the list.

3.8.3.1.2. Clear all connections

To clear all connection allocations in the connection list, press CLEAR  and then press OK  to confirm.

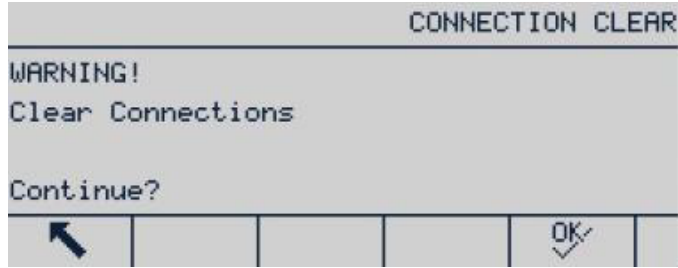

Figure 3-82: Delete Warning Screen

3.8.4. COM1

The COM1 communication setup screen provides configures the COM1 serial port, active or passive current loop communication parameters.

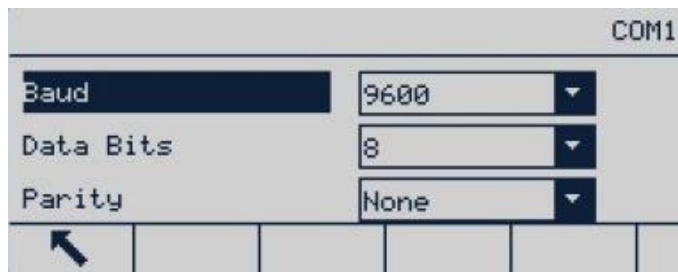

Figure 3-83: COM1 (Serial) Setup Screen

3.8.4.1. Baud Rate

Use Baud selection box to set the Baud rate at the serial port. Options are:

1200, 2400, 4800, 9600 [default], 19.2k, 38.4k, 57.6k, 115.2k

3.8.4.2. Data Bits

Use Data Bits selection box to set the number of data bits. Options are:

7, 8 [default]

3.8.4.3. Parity

Use Parity selection box to set the parity. The options are:

None [default], odd parity check, even parity check

3.8.4.4. Ethernet

3.8.4.4.1. MAC Address

The Media Access Control (MAC) address cannot be edited and is only displayed to provide information.

3.8.4.4.2. DHCP Client

If the IP address, subnet mask and gateway address field are allocated automatically by the network using DHCP (Dynamic Host Configuration Protocol), these parameters will be read-only in

the setup screen. If DHCP is disabled, the IP address must be manually allocated in the following fields. DHCP options are:

Disabled [default], Enabled

- 3.8.4.4.3. IP Address
Enter the IP address of the IND256x terminal (or view the address, if DHCP client is enabled). Press ENTER after entering each group of figures to move focus to the next group. The default IP is 192.68.0.1.
- 3.8.4.4.4. Subnet Mask
Enter the subnet mask of the IND256x terminal (or view the address, if DHCP client is enabled). Press ENTER after entering each group of figures to move focus to the next group. The default subnet mask is 255.255.255.0.
- 3.8.4.4.5. Gateway Address
Enter the gateway address of the IND256x terminal (or view the address, if DHCP client is enabled). Press ENTER after entering each group of figures to move focus to the next group. The default gateway is blank.

After entering, press EXIT softkey  to return to the menu tree.
- 3.8.4.4.6. Server
The IND256x terminal can execute SICS commands from a PC. The terminal must be configured as Server and the PC must be configured as Client.
- 3.8.4.5. Ethernet mode MOVE UP
Switch the network connection mode between server and client. If the server mode is selected, the default port communicating with other client is 1701.
- 3.8.4.6. Print Client
The Print Client connection allows IND256x to send data directly to a specific IP address in the same network with IND256x.
 - 3.8.4.6.1. Server IP Address
Enter the IP address for the PC or laptop or printer as the Server IP Address. This is the IP address of the device to which the IND256x sends print information. The default IP address is 0.0.0.0.
 - 3.8.4.6.2. Server TCP Port
Enter the TCP port number of the service of the device to which the data is to be sent. The default port is 8000.



Figure 3-84: Print Client Configuration

3.8.5. WiFi

3.8.5.1. WiFi Account

3.8.5.1.1. SSID (Service Set Identifier)

Enter the name of the wireless network to which the IND256x will connect. Refer to section 2.3, Data Input, for instructions on how to input data using the numeric keypad. Please note that the SSID is case sensitive.

3.8.5.1.2. Password

Enter the password of the wireless network the IND256x is going to connect. Refer to section 2.3, Data Input, for instructions on how to input data using the numeric keypad. Please note that the password is case sensitive.

3.8.5.2. Print Client

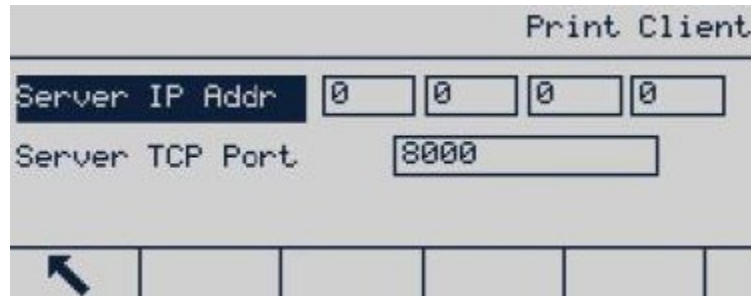

Figure 3-85: Print Client Configuration

3.8.5.2.1. Server IP Address

Enter the IP address for the PC, laptop or printer as the Server IP Address. This is the IP address of the device to which the IND256x sends print information. The default IP address is 0.0.0.0.

3.8.5.2.2. Server TCP Port

Enter the TCP port number of the service of the device to which the data is to be sent. The default port is 8000.

3.8.5.3. Ethernet

3.8.5.3.1. MAC Address

The Media Access Control (MAC) address cannot be edited and is only displayed to provide information.

3.8.5.3.2. DHCP Client

If the IP address, subnet mask and gateway address field are allocated automatically by the network using DHCP (Dynamic Host Configuration Protocol), these parameters will be read-only in the setup screen. If DHCP is disabled, the IP address must be manually allocated in the following fields. DHCP options are:

Disabled [default], Enabled

3.8.5.3.3. IP Address

Enter the IP address of the IND256x terminal (or view the address, if DHCP client is enabled). Press ENTER after entering each group of figures to move focus to the next group. The default IP is 192.68.0.1.

3.8.5.3.4. Subnet Mask

Enter the subnet mask of the IND256x terminal (or view the address, if DHCP client is enabled). Press ENTER after entering each group of figures to move focus to the next group. The default subnet mask is 255.255.255.0.

3.8.5.3.5. Gateway Address

Enter the gateway of the IND256x terminal (or view the address, if DHCP client is enabled). Press ENTER after entering each group of figures to move focus to the next group. The default gateway is blank.

After entering, press EXIT softkey  to return to the menu tree.

3.8.5.4. Ethernet Mode

3.8.5.4.1. Ethernet Mode

Switch the network connection mode between server and client. If the server mode is selected, the default port communicating with other client is 1701.

3.8.5.5. WiFi Router Setup

By default, IND256x WiFi communication uses channels selected from the range 1 to 11. Make sure that the related WiFi Router is configured to use the same range of channels.

3.8.5.6. WiFi Communication Mechanism



The IND256x terminal will automatically switch to another access point with the strongest signal strength when it loses connectivity with its current access point, if there are other access points distributed in the area. Please ensure that the WiFi signal strength is $>-65\text{dB}$ to guarantee continuity of wireless communication.





3.8.6. Analog Output

The analog output of the IND256x terminal provides 4-20 mA output. The output can be configured to represent either the displayed weight or the gross weight.

To configure analog output:

1. Choose the appropriate source from the Source field selection box. Source options include:

- a. None
 - b. Displayed Weight [default]
 - c. Gross Weight
2. In the Zero Value field, enter the weight value [default: 0 kg] at which the 4 mA output of the analog signal should occur.
 3. If the programmed values do not provide the exact outputs required, they can be trimmed as follows, by using the ZERO and SPAN softkeys located at the bottom of the screen:
 - a. Press the ZERO softkey to initiate the zero fine-tuning process or the SPAN softkey to initiate the span fine-tuning process.
 - b. In either case, a prompt will offer two options: OK to continue with the operation, or ESCAPE to return to the previous screen without making any adjustment.
- Note: The analog output signal value will change during this procedure; ensure that the PLC or other control equipment is disconnected.
- c. A warning message will display, requesting verification to continue.
 - d. Once the OK softkey  is pressed, the zero fine-tuning or span fine-tuning operation begins. A message will display, showing the current value of the analog output signal. Use the softkeys below to adjust the signal if necessary.
-  Bump Down
(faster adjustment down)
 Bump Up
(faster adjustment up)

 Nudge Down
(slower adjustment down)
 Nudge Up
(slower adjustment up)
- e. Press the EXIT softkey  to return to the previous screen.
4. In the Full Scale Value field, enter the weight value [default: 50 kg] at which the 20 mA output of the analog signal should occur. Please note that the weight value should be larger than that of the zero value.
 5. Refer to step 3 to trim the Full Scale Value if the programmed values do not provide the exact outputs required.
 6. Press the EXIT softkey  to return to the menu tree.

3.8.7. Current Loop Interface

Active and passive current loop interfaces are available using the appropriate option board.

3.8.8. Reset

The Reset setup screen restores the Communications parameters to their factory default settings. Select Reset, then press the OK softkey . In case of reset success, a message will appear indicating "Reset successful". If reset fails, an error message will appear indicating "Reset failed". In case of a failed reset, re-try the process. If it continues to fail, contact your local METTLER TOLEDO representative for help.

Press the ESCAPE softkey  to exit without resetting.

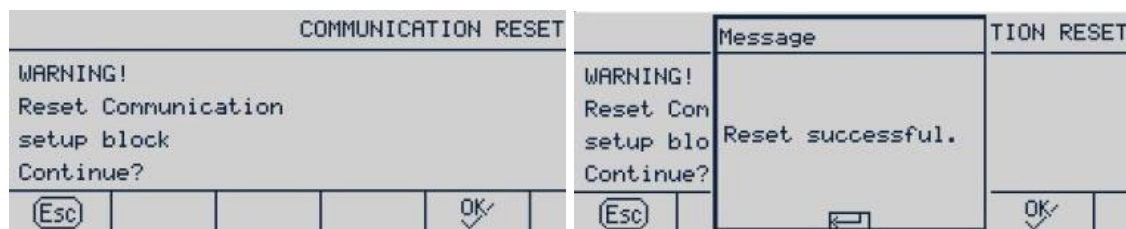

Figure 3-86: Communication Reset Screens

3.9. Maintenance

The Maintenance branch includes diagnostics, software upgrade installation, parameter backup to an SD card, parameter recovery from an SD card, file download, and a master reset function.

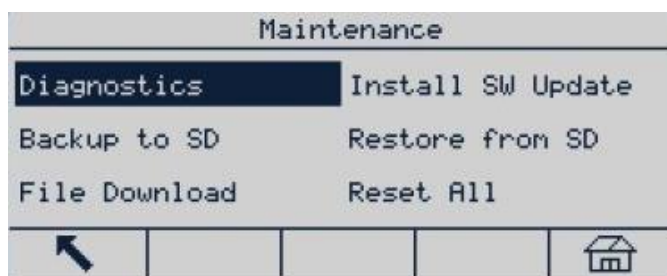

Figure 3-87: Maintenance Menu

3.9.1. Diagnostics

The Diagnostics test setup screen includes a variety of functions – tests for the display, keyboard, scale and serial communication.

3.9.1.1. Display Test

When the Display test is selected, press ENTER to display alternating off/on spot patterns.

Press the EXIT soffkey  to return to the menu tree.

3.9.1.2. Keyboard Test

The Keyboard test screen allows the terminal keys to be tested. These include soffkeys, scale function keys, navigation keys and alphanumeric keys.

Press any key and the screen will display the symbol of the key pressed.

Press EXIT soffkey  to return to the menu tree.

3.9.1.3. Scale

The possible scale diagnosis setup screens include Load Cell Output, Calibration Values and Statistics.

3.9.1.3.1.

Load Cell Output

The Load Cell Output screen displays the current count value (active value) of the scale.

Press EXIT softkey  to return to the menu tree.

3.9.1.3.2.

Calibration Values

The Calibration values screen displays the current calibration values configured for the scale.

These calibration values may be recorded and, in case of failure, manually entered after a new main board is installed, making it unnecessary to calibrate the scale again by test weights. This method is fast, but it is less accurate than recalibration using test weights.

Use the numeric keyboard to enter a new value.

Press EXIT softkey  to return to the menu tree.

3.9.1.3.3.

Statistics

The Scale Statistics screen displays the scale statistical information, such as number of weighments (incremented when triggered by each transaction), number of overloads (incremented when the load applied on single load cell exceeds its overload capacity), peak weight (maximum weight recorded by the scale), number of clear operations (incremented on each receipt of the operator's or a remote clear command) and number of clear failures (incremented each time in case of failure upon receipt of the operator's or a remote clear command).

Use the navigation keys to scroll and view all information and records. Press EXIT softkey  to return to the menu tree.

3.9.1.4.

Serial Test

The Serial Test screen allows self-diagnosis test for the serial port to determine whether the hardware port is functional (self-diagnosis test for SMS sending and receiving port).

3.9.2. Install SW (Software) Upgrade

The IND256x terminal supports the on-site upgrade of software, using an SD card. Use the drop-down box to select the software file from the SD card.

Note that the file name of terminal firmware should be 256X***.hex (where *** is the revision number).

To eliminate possible memory errors, it is recommended that the user execute a Master Reset after downloading new software.



Figure 3-88: Software Upgrade Screen

3.9.3. Backup to SD Card

This function allows the terminal parameters to be backed up to an SD card. Press Start to begin the back up.

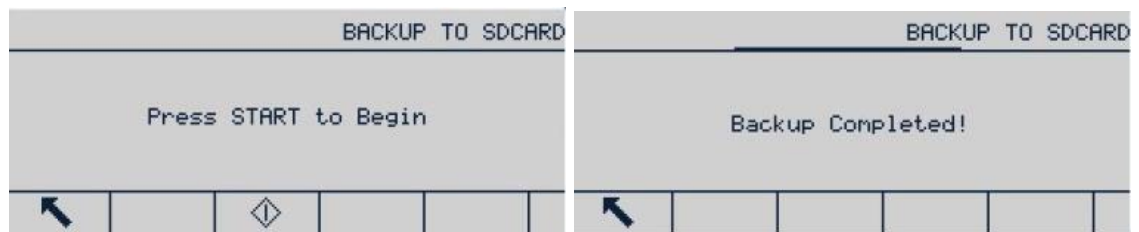

Figure 3-89: Backup Screens

3.9.4. Restore from SD Card

Here, the user can recover the terminal parameters from an SD card. Use the drop-down box to choose whether to recover calibration parameters only, or to recover calibration and setup parameters together.



Figure 3-90: Recovery Screens

3.9.5. File Download

This function allows data files to be downloaded from the terminal. First, set the port to be used for this operation, then select the appropriate file from the File Name drop-down list. The port options are None [default], serial 1 and serial 3.

The optional filenames include:

ctemp1.prn, ctemp2.prn, ctemp3.prn, ctemp4.prn, ctemp5.prn, ID1.csv, ID2.csv, ID3.csv

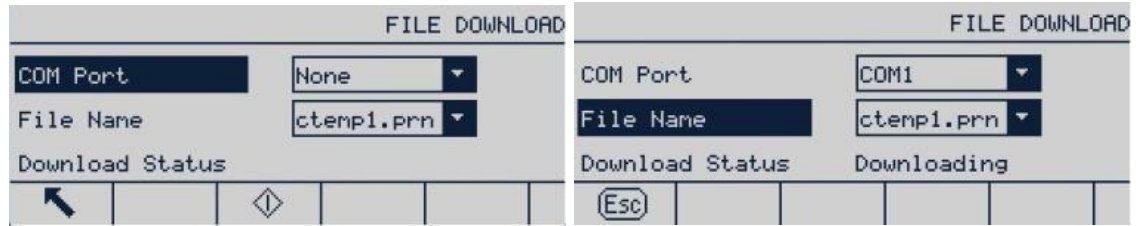



Figure 3-91: File Download Screens

Press RUN  to start the download. If no port is selected, a message will appear indicating that an invalid value is selected.

3.9.5.1. Reset All (Factory Default Values)

Use the maintenance menu's Reset All option to return all setup parameters to their factory default states.

- The "Reset All" function resets all parameters in the terminal, except for metrologically significant settings, such as scale type and capacity.

When the Reset All screen is accessed, a message appears, requiring confirmation for the operation. To continue, press OK softkey. If the reset succeeds, a confirmation message appears, showing "Reset success". If the reset fails, an error message appears, showing "Reset failed". If the reset fails, try to reset again. If it continues to fail, contact your local METTLER TOLEDO representative for assistance.

Press the ESCAPE softkey  to exit without resetting.



Figure 3-92: Maintenance Reset Screens

4 Service and Maintenance



Operational reliability is built into the design of the IND256x terminal. However, METTLER TOLEDO suggests that like any industrial equipment, the terminal and the system connected with the scale should be maintained regularly. The METTLER TOLEDO technical service department provides timely and regular maintenance and calibration, and records and saves accurate and reliable parameters to meet technical specifications.

4.1. Terminal Cleaning and Maintenance

To clean the IND256x terminal's keypad and cover:

- Gently wipe the IND256x terminal's keypad and cover with a clean, damp, soft cloth.
- Use water or mild, non-abrasive cleaning agents.
- Do not use any type of acids, alkalis or strong industrial solvents such as toluene or isopropanol (IPA) that could damage the terminal's finish.
- Do not spray cleaner directly on the terminal.
- Do not clean the terminal using high-pressure or high-temperature water.
- The build-up of dust layers must be avoided.
- Remove light dust deposits using a damp cloth with a gentle wiping motion.
- Do not use compressed air or vacuum to remove dust layers.
- Follow good housekeeping practices to keep the terminal clean.

Regular maintenance inspections and calibration by a qualified service technician are recommended.

	 WARNING
	IF THE IND256X KEYBOARD, DISPLAY LENS OR ENCLOSURE IS DAMAGED, THE DEFECTIVE COMPONENT MUST BE REPAIRED IMMEDIATELY. REMOVE POWER IMMEDIATELY AND DO NOT REAPPLY POWER UNTIL THE DISPLAY LENS, KEYBOARD OR ENCLOSURE HAS BEEN REPAIRED OR REPLACED BY QUALIFIED SERVICE PERSONNEL. FAILURE TO DO SO COULD RESULT IN BODILY HARM AND/OR PROPERTY DAMAGE.

4.2. Service

Only qualified personnel should perform installation, programming, and service. Please contact a local METTLER TOLEDO representative for assistance.

In general, once the IND256x is installed, programmed, and calibrated for a given application, only routine calibration service is required.

	WARNING
	PERMIT ONLY QUALIFIED PERSONNEL TO SERVICE THE TERMINAL. EXERCISE CARE WHEN MAKING CHECKS, TESTS AND ADJUSTMENTS THAT MUST BE MADE WITH POWER ON. FAILING TO OBSERVE THESE PRECAUTIONS CAN RESULT IN BODILY HARM AND/OR PROPERTY DAMAGE.

4.2.1. General Safety Guidelines for Service

When performing on-site service or maintenance, only carry out work on the weighing terminal in the hazardous area if the following conditions are fulfilled:

- The certification papers (conformity certificates, control drawing, manufacturer certifications, etc.) are present and can be used to confirm the correctness and safety of the installation
- The intrinsically safe entity parameters and area approval of the individual components are in accord with one another
- The customer has issued a permit ("spark permit" or "fire permit")
- The area has been rendered safe and the owner's safety coordinator has confirmed that there is no danger
- The necessary tools and any required protective clothing are provided (to avoid the danger of a build-up of static electricity)

4.3. Error Messages

The IND256x uses error messages to indicate error conditions that occur in the terminal. A list of possible error codes is given in Table 4-1. Error messages will be shown in the top (system) line of the display and will overwrite the date/time information if enabled in setup. After the message is cleared, the display reverts to the data shown before the error was detected.

Table 4-1: Error Messages and Explanations

Prompt message	Explanation / Solution
Access denied. The scale is in approved state.	Cancel the terminal's approval by selecting None in setup at Scale > Type > Approval
Exceed scale capacity	Check the set value of the scale range
Error: AD is subject to final factory test	This terminal shall be subject to factory test
The cell signal has been saturated. Please use new range for calibration	Check the set value of the scale range

Prompt message	Explanation / Solution
! Warning! Are the results saved after completion of correction in motion state?	It is recommended to keep the weighing body still for re-calibration
Increased test weight is not detected	Check the loaded weight or check the cell signal input
Calibration prohibited	Check the terminal's approval status
Zero adjustment failed	Check whether the scale is in motion
Default recovery error.	Replacement of the mainboard is recommended
Password error	Check password output
Report print connection is not set. Press Enter to continue	Check print connection setting
The target value exceeds the range.	Check the range set value to ensure that the range is greater than the target value.
Analog output invalid!	Check whether the analog board supplies power normally or is damaged
ALIBI storage failed!	Check whether SD card is inserted correctly
Cumulative overflow	Clear cumulative value
Zero failed – motion	Try again after the scale is stable
Zero failed – scale in net weight mode	Execute a clear operation and return to gross mode
Zero failed – beyond range	Check the set zero range
Tare failed- motion	Try again after the scale is stable
No cell signal	Check the cell signal line input
Display exceeded!	Configure the scale's capacity and increment so that displayed weight will not exceed six digits.
Fail to execute tare table operation!	Check whether the tare table is enabled
Fail to convert units!	Check whether the unit conversion is enabled
Fail to execute X10 display!	Check whether X10 display function is enabled
No print connection	Enter print setup and configure print connection
Print busy	Other tasks are being printed. Please try again later.
Print is not ready	Check whether the serial connection is set correctly
Fail to execute target value table operation!	Check whether the target value table is enabled
Check weight process stop.	Check whether the target value is set correctly
WIFI VERIFY FAULT	Check whether there is electromagnetic equipment nearby, and avoid interference
WIFI WRXACTIVE FAULT	Failed to start 802.11 Radio: suggest replacement of Wi-Fi module
WIFI WD FAULT	Failed to read revision of Firmware: suggest replacement of Wi-Fi module
WIFI WM FAULT	Failed to set work mode: suggest replacement of Wi-Fi module
WIFI DHCPENABL FAULT	Failed to enable DHCP: suggest replacement of Wi-Fi module
WIFI DHCPDISABLE FAULT	Failed to disable DHCP: suggest replacement of Wi-Fi module



Prompt message	Explanation / Solution
WIFI NSET FAULT	Failed to set static IP, mask IP and gateway: suggest replacement of Wi-Fi module
WIFI WAUTH FAULT	Failed to configure work mode: check the revision of Wi-Fi module
WIFI WSEC FAULT	Failed to set encryption mode: check whether the encryption setting of router is compatible with IND256x
WIFI SSID FAULT	Failed to search WLAN: check whether SSID and password are correct and channel is 0-11
WIFI WA FAULT	Failed to join WLAN: check whether DHCP setting is correct or MAC address is registered in IT server
WIFI BADATA FAULT	Failed to execute data communication: suggest replacement of Wi-Fi module
WIFI NSTAT FAULT	Failed to inquire IP address: suggest replacement of Wi-Fi module
Baud rate error	There is a communication error between Wi-Fi module and mainboard. Please check the revision of Wi-Fi module
WIFI No Connection	During printing, Wi-Fi connection is not reliable.

4.4. System Information

Only service personnel with appropriate tools may install, program and service the IND256x. Contact your local METTLER TOLEDO representative for help.

- Contact information on local service provider may be found in the terminal. Press the Information recall  softkey to view any available service contact information.

METTLER TOLEDO recommends regular preventive maintenance for the terminal and the scale system to ensure reliability and maximize uptime. All measuring systems should be regularly calibrated and certified as required to meet production, industry and regulatory requirements. Through regular maintenance and adjustment services, we can help you maintain the working time, compliance and quality system materials. Contact a local METTLER TOLEDO authorized service organization to discuss your requirements.

	 WARNING
	ONLY PROFESSIONAL SERVICE PERSONNEL ARE ALLOWED TO MAINTAIN THIS TERMINAL. PLEASE BE CAREFUL DURING INSPECTION, TEST AND ADJUSTMENT. INCORRECT OPERATION MAY RESULT IN INJURY.

4.5. Firmware Upgrade

	 WARNING
	ONLY SERVICE PERSONNEL WITH PROFESSIONAL TECHNOLOGY MAY UPGRADE THE TERMINAL FIRMWARE. CONTACT YOUR LOCAL METTLER-TOLEDO REPRESENTATIVE FOR HELP.

If a new IND256x***.hex file is copied to the SD Memory card from a PC, the firmware can then be updated by the following procedure.

1. Remove power from the terminal and insert the SD memory card with the IND256x***.hex file copied to it into the SD memory card slot on the Main Board.
2. Power up the terminal and access Setup > Maintenance > Install SW Update.
3. A message of [WARNING! Install new software from SD memory?] will appear on the display. To exit without performing the firmware upgrade, press the LEFT navigation key.

To perform the upgrade, in the File Name parameter, select the firmware file to be uploaded. Only files on the SD card named in the format IND256x***.hex will be displayed.

4.6. Backup and Restore Using InSite™

4.6.1. InSite SL

InSite SL is an application for the PC that can be used to save the terminal configuration and restore it at a later date, or copy configurations into other terminals. InSite SL cannot be used to upgrade firmware or carry out terminal configuration.

Procedures for importing and exporting files using InSite SL are provided in the [InSite SL User's Guide](#). The InSite™ SL PC tool is available for download at mt.com.

- Please note that the COM of IND256x must be configured to Shared Data Server, and the InSite Baud rate set to 57600.

4.7. Troubleshooting

Troubleshooting activities for the IND256x include:

- Power Test
- Load Cell Power Testing
- Battery test
- Internal Diagnostic Testing
- RS-232 Serial Output Voltage Testing
- WiFi option board testing

4.7.1. Power Test

If the display is blank or if intermittent problems are occurring, the condition of the power source should be checked.

Begin by checking the input power supplies. Please refer to Figure 4-1 and Table 4-2 for pin testing positions and expected voltages in the various power supply versions.

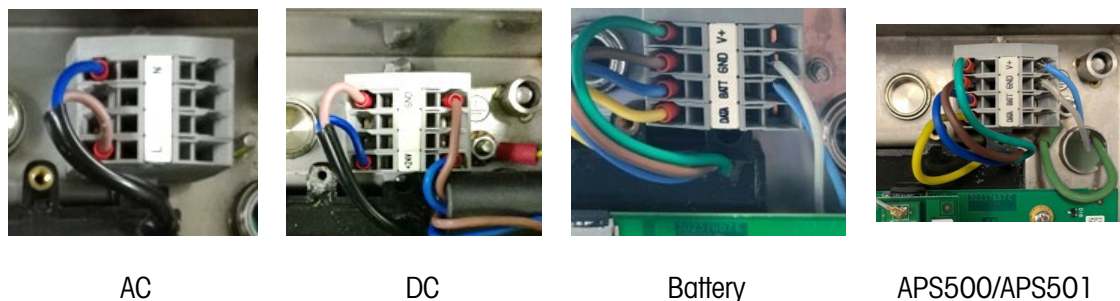

Figure 4-1: Pin Locations on IND256x Power Supply Connection Terminal

Table 4-2: Input Voltages for IND256x

Measuring Point	Setpoint [V]		Remarks
	Min	Max	
L – N	187VAC	250VAC	AC version
+24V – GND	18VDC	30VDC	DC version
BATT – GND	9VDC	12.6VDC	When connected to battery
V+ – GND	9VDC	11.7VDC	When connected to APS500/501

For both the AC and DC versions, if no power is present at the IND256x input, ensure that the AC or DC power is present at the source. Otherwise, have a qualified electrician at the site restore power at the source.

For the battery version, if no voltage or only small voltage is present at the IND256x input, check that the battery has been charged. If the battery output voltage is correct, check the connection of the cable between battery and IND256x terminal.

When IND256x is connected with an APS500, if the voltage value presenting at the terminal input is not in range, disconnect the APS500 and measure the output voltages. If they are also incorrect, refer to APS500 Power Supply Service Manual (64062815) for further information. Otherwise, check the connection of the cable between APS500 and IND256x terminal.

For all versions, if the voltage value at the IND256x input is in range, the next step is to test the encapsulated power supply module's output voltages. Refer to Figure 4-2 and Table 4-3 for pin testing positions and expected voltages.

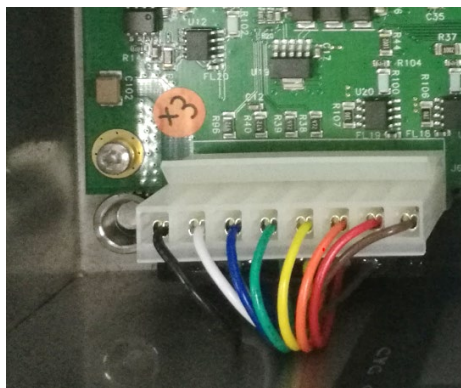

Figure 4-2: Pin Locations of the Encapsulated Power Supply Module

Table 4-3: Output Voltages of the Encapsulated Power Supply Module

Measuring Point (Wire color)	Setpoint [V DC]	
	Min	Max
J6_1 (Brown) – J6_7 (Black)	4.9	5.2
J6_2 (Red) – J6_7 (Black)	4.7	5.0
J6_3 (Orange) – J6_7 (Black)	4.9	5.2

For all versions, if the voltage values at the IND256x main board input are not in range, disconnect the connection between the encapsulated power supply module and the main board, and recheck the output voltage of the power supply module. If the voltage values are still out of range, replace the power supply module with a new one; otherwise, check the main board, option board and other modules (such as LCD, Load Cell etc.), step by step.

4.7.2. Load Cell Power Test

When measuring the output voltages of a connected analog load cell system, be sure that the IND256x is powered on and the scale is correctly connected. Refer to Figure 4-3 and Table 4-4 for pin testing positions and expected voltages of the analog load cell connection.



Figure 4-3: Analog Load Cell Connection Terminal

Table 4-4: Analog Output Voltages

Measuring Point	Setpoint [V DC]	
	Min	Max
J5_1 – J5_7	4.2	4.8

4.7.3. Battery Tests

If setup parameters change uncontrollably or programming is lost, check the BRAM battery voltage. Battery voltage is tested at the battery assembly on the Main PCB. The battery testing positions are shown in Figure 4-4.

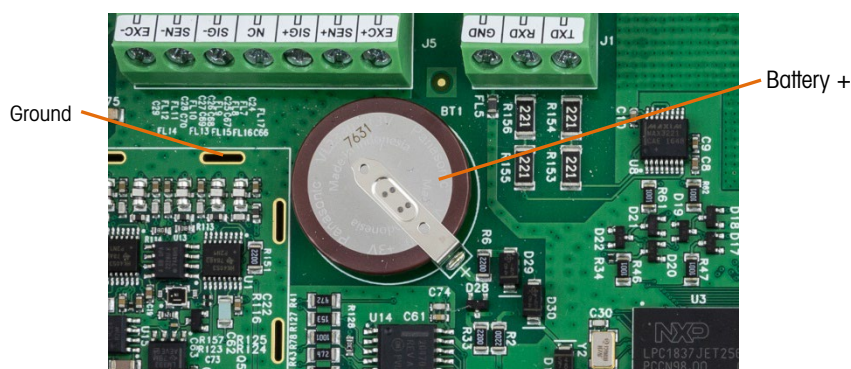
**Figure 4-4: Battery Test**

With the power disconnected from the terminal, use a Volt-Ohm meter to measure voltage between the top of the battery (+) and ground. This measurement should be approximately 3.0 to 3.4 VDC. Replace the Main PCB if the measured voltage is below 2.5 VDC.

4.7.4. Internal Diagnostic Testing

The IND256x provides several internal diagnostic tests that are accessible in setup mode. Press the SETUP softkey  to view the setup menu tree. Use the navigation key to Maintenance menu. Press ENTER key and then select the Diagnostics menu. Press ENTER key to enter the menu, available diagnostic setup screens include the following.

4.7.4.1. Display Test

This test displays an alternate off/on dot block pattern when accessed. Press any key to return the menu tree.

4.7.4.2. Keyboard Test

This is a test of the keyboard. When a key is pressed, the corresponding symbol will be shown on the display. When testing is complete, press the EXIT softkey  to return to the menu tree.

4.7.4.3. Scale

4.7.4.3.1. Load Cell Output

Displays the current load cell output (active weight) for the scale, in counts.

4.7.4.3.2. Calibration Values

Displays the current calibration values for the scale. If these values are recorded after a scale calibration, and the Main PCB is replaced in the future, the calibration values can be manually entered here to transfer the existing calibration to the new Main PCB.

4.7.4.3.3. Statistics

Displays statistical information for the scale such as the total number of weighments, the number of scale overloads, the peak weight weighed on the scale, the total number of zero commands and failed zero commands. These are very helpful when diagnosing scale problems.

4.7.5. RS-232 Serial Output Voltage Test

If tests of the transmission and reception functions on the COM1 serial ports fail, use the following procedure to determine whether the RS-232 serial port is operational:

1. Remove power from the IND256x terminal and the printer.
2. Disconnect the data cable from the printer.
3. Set the voltmeter to read 20 VDC.
4. Connect the red lead to the transmit terminal of the COM port and connect the black lead to the ground terminal of the COM port.
5. Apply power to the IND256x. The meter should read as follows:
 - Demand mode – The meter should read a stable value (without fluctuation) between -4.55 and -5.36 VDC.
 - Continuous mode – The meter should fluctuate continuously within the range -5.36 to $+5.36$ VDC. The actual values and degree of fluctuation observed will depend on the type and sensitivity of the meter used. The constant fluctuation on the meter display indicates that the scale/terminal is transmitting information.

To test Demand baud rates, press the PRINT key . The display should fluctuate as for continuous mode for the duration of the transmission, then become stable again. This fluctuation indicates the terminal has transmitted data.

- When measuring higher baud rates in Demand mode, the meter display will fluctuate less, and for a shorter period of time.

4.7.6. Wi-Fi Option Board Power Test

If Wi-Fi function fails, ensure the software configuration is correct firstly. If the software sets are right, then check the connection of antenna. If the connection of antenna is OK as well, please refer to Figure 4-5 and Table 4-5 for testing positions and expected voltages.

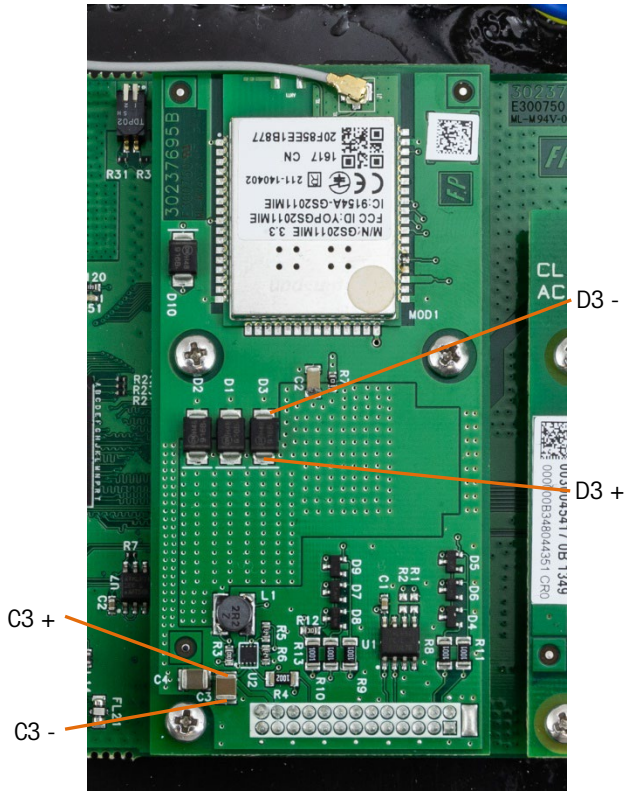

Figure 4-5: Testing positions for Wi-Fi board

Table 4-5: Expected voltages for Wi-Fi board

Measuring Point	Setpoint [V DC]	
	Min	Max
C3	4.9	5.2
D3	2.9	3.1

If the voltages are out of the range, please replace the Wi-Fi option board with a new one. Otherwise, check the software sets for Wi-Fi again.

	 WARNING
	USE ONLY METTLER TOLEDO SPARE PARTS WHEN REPLACING THE WIFI MODULE. METTLER TOLEDO ACCEPTS NO RESPONSIBILITY FOR SAFETY OR COMPLIANCE RISKS CAUSED BY USE OF INCORRECT COMPONENTS.

4.8. Master Reset

The master reset function is provided to reset IND256x terminal settings to the factory default setting.

- Before executing a master reset, make sure to back up the terminal configuration and scale calibration to SD card device. Upon completion of master reset, this data can be reloaded to the terminal.

A master reset is generally used under the following conditions:

- When a software configuration problem cannot be solved without starting from the factory default settings.
 - When the user security is enabled to protect unauthorized access or use, and the "admin" account password is lost.
- A master reset is recommended after a firmware upgrade is implemented.

4.8.1. Perform a Master Reset

1. Remove AC or DC power from the terminal.
2. Turn SW1-2 to ON, as shown in Figure 4-6.

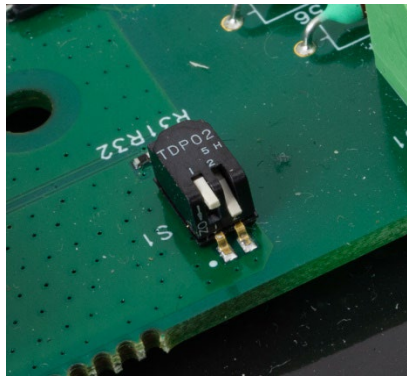

Figure 4-6: Metrology Switches SW1 OFF, SW2 ON

- If the metrology data is to be reset, SW-1 and SW1-2 should be set to ON simultaneously, as shown in Figure 4-7.

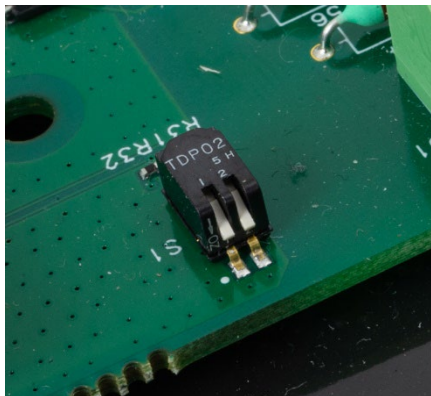

Figure 4-7: Metrology Switches SW1-1 and SW1-2, Both ON

3. Apply AC or DC power. The display will indicate the indication warning information during power-up sequence.

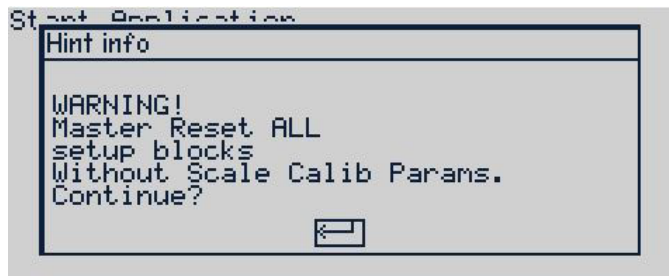

Figure 4-8: Master Reset Warning

4. Press "ENTER" to execute master reset and return all settings to their factory default values. A power cycle process is activated and the terminal restarts and displays its home screen.
 - To exit without executing the master reset, remove power from the terminal, return SW1-1 and SW1-2 to their original position, then re-apply DC or AC power.
5. Return SW1-1 and SW1-2 to OFF, as shown in Figure 4-9.

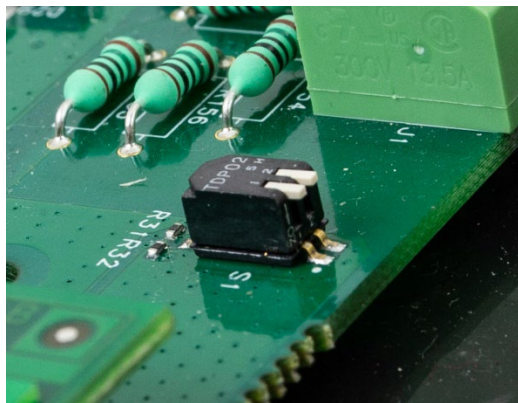

Figure 4-9: Metrology Switches SW1-1 and SW1-2, Both OFF

A Parameter Values

■ Default values are indicated in bold.

Parameter	Options	
Scale		
Type		
Name	[Manual entry] Scale 1	
Type	Analog, Remote	
Approval	None, USA, OIML, Australia, Canada, Thailand	
Certification #	[Manual entry]	
Capacity & Increment		
Primary Units	kg, lb, t, ton, g	
# Ranges/Intervals	1, 2 Intervals, 2 Ranges, 3 Intervals, 3 Ranges	
>[1]<	[Manual entry] 50 x 0.01 kg	
Blank Over Capacity	[Manual entry] 5d	
Calibration		
GEO Code	[Manual entry] 16	
Base Serial Number	[Manual entry]	
Calibration Units	kg, lb, t, g	
Linearity Adjust	Disabled, 3-point, 4-point, 5-point	
Zero		
Auto Zero	Gross, Gross & Net, Disabled	
Auto Zero Range	0.5d, 1d, 3d, 10d	
Under Zero Blanking	Disabled, 10d, 20d	
Power Up Zero	Disabled, +/-2%, +/-20%	
Pushbutton Zero	Disabled, +/-2%, +/-20%	
Tare		
Types	Pushbutton Tare	Enabled, Disabled
	Keyboard Tare	Enabled, Disabled
	Net Sign Correction	Enabled, Disabled

Parameter	Options	
Auto Tare	Auto Tare	Enabled, Disabled
	Tare Threshold Wt.	[Manual entry] 0 kg
	Reset Threshold Wt.	[Manual entry] 0 kg
	Motion Check	Enabled, Disabled
Auto Clear	Auto Clear Tare	Enabled, Disabled
	Clear Threshold Wt.	[Manual entry] 0 kg
	Motion Check	Enabled, Disabled
	Clear After Print	Disabled, Enabled
	Clear With Zero	Disabled, Enabled
	Power Up	Restart, Reset
Units		
Second Unit	None, 1 : g, 2 : kg, 3 : lb, oz, 4 : t, 6 : ton	
Power Up	Restart, Primary Unit	
Filter		
Low Pass Frequency	[Manual entry] 2 Hz	
Lo Pass # of Poles	2, 4, 6, 8	
Notch Filter Frequency	[Manual entry] 30	
Stability Filter	Enabled, Disabled	
Stability		
Motion Range	[Manual entry] 1.0 d	
No-Motion Interval	[Manual entry] 0.3 seconds	
Timeout	[Manual entry] 3 seconds	
MinWeigh		
MinWeigh	Disabled, Enabled	
MinWeigh Value	[Manual entry] 0 kg	
Log or Print		
Minimum weight	[Manual entry] 0 kg	
Interlock	Enabled, Disabled	
Automatic	Enabled, Disabled	
Reset On	Return, Deviation	
Threshold Weight	[Manual entry] 0 kg	
Motion Check	Disabled, Enabled	
Reset		
Application		
Memory		
Alibi Memory	Disabled, Alibi Memory	

Parameter	Options		
Tare Table	Totalization	None, Gross Weight, Displayed Weight	
	Description	Disabled, Enabled	
Tare ID	ID 1, ID 2, ID 3		
Transaction Log	Transaction Table	Disable, Enable	
	Trans. Log Config.	Item # [1~4] [None ~ ID3DESC]	
	Trans. Log Search	Search Field 1	[Transaction]
		Data	[=] *
		Search Field 2	[None]
		Data	[=] *
App assignment			
App Assignment	Basic Weighing, Checkweighing		
Checkweighing			
Operation	Source	Displayed Weight, Gross Weight	
	Tolerance Type	Target Deviation, Weight Value, % Of Target	
	Target Editing	Disabled, Target Only, Target & Tolerance	
	Hold Time	[Manual entry] 0 Sec	
	Motion Check	Disable, Enable	
	Restrict Print	Disable, Enable	
	Print On Removal	Disable, Enable	
Display	Display Mode	Actual Weight, Target Deviation, No Display	
	Smart Trac	Enable, Disable	
	Motion Blanking	Disable, Enable	
Target Table	Totalization	Disable, Enable	
	Clear Totalization	Manual, Disable, Automatic	
Totalization			
Mode	None, Displayed Weight, Gross Weight		
Clear GT on Print	Enabled, Disabled		
Subtotal	Enabled, Disabled		
Clear ST on Print	Enabled, Disabled		
Transaction Counter			
Transaction Counter	Enabled, Disabled		
Counter Reset	Enabled, Disabled		
Next Transaction	[Manual entry] 0000001		
Reset			

Parameter	Options	
Terminal		
Device		
Serial Number	[Manual entry]	
Battery Type	None, Li, NiMH	
Service Contract	[Manual entry] 4008878989	
Display		
Backlight Timeout	1 Min., 5 Min., 10 Min, Always on, Disabled	
Auto Off Timer	Disabled, 10 Min., 30 Min., 60 Min.	
System Line	Time & Date, Blank	
Backlight Level	Mid, High, Low	
Tare Display	Always, Never, Tare-Activated	
Adjust Contrast	[UP and DOWN arrow keys]	
Region		
Format Time & Date	Time Format	24:MM:SS, 12:MM, 12:MM:SS, 24:MM
	Date Format	DD/MMM/YYYY, MM/DD/YY, MMM/DD/YYYY, YY/MM/DD, YYYY/MMM/DD, YYYY/MM/DD, DD/MM/YY
	Date field separator	/, -, ., (space), None
Set Time & Date	Hour	[Manual entry]
		AM, PM
	Minute	[Manual entry]
	Day	[Manual entry]
	Month	January, February, March, April, May, June, July, August, September, October, November, December
Year	[Manual entry]	
Language	Display Language	English, Spanish, German, French, Italian, Portuguese, Chinese, Polish
Users		
Password	[Manual entry]	
Confirm Password	[Manual entry]	
Softkeys #		
Softkey Edit	None, Setup, Recall Info, Unit Switching, x10 Display, Alibi, Reports, Time & Date, Repeat Print, Tare Table, Tare Table View, Adjust Contrast, MinWeigh, Transaction Count, Target, Target Table View, Totals Report, ID	
Reset		

Parameter	Options		
Communication			
Templates			
Input	Preamble Length	[Manual entry] 0	
	Data Length	[Manual entry] 1	
	Postamble Length	[Manual entry] 0	
	Termination character	CR, SO, SI, DLE, DC1, DC2, DC3, DC4, NAK, SYN, ETB, CAN, EM, SUB, ESC, FS, GS, RS, US, None, SOH, STX, ETX, EOT, ENQ, ACK, BEL, BS, HT, LF, VT, FF	
	Assignment	TARE, Tare ID, Target ID, keypad	
Output	Template 1	Type	Fixed width, Single Line, EX200, Label Print
		Fields	Gross, Net, Tare, Unit, T Type, Date, Time, ScaleNa., TransID, G/N, Total, SubTotal, TotalCount, SubCount, TransDsc, TargetVal, Target-, Target+, Tar Type, Tar ID, Tar Total, TarCount, Result, Line Feed, String 1, String 2, String 3, ID1 Index, ID2 Index, ID3 Index, ID1 Desc, ID2 Desc, ID3 Desc, Template End, NONE, Display
	Separation char.	, ; ~ ^	
	Print Width	[Manual entry] 30	
	Format	1, 2, 3	
	Line/Feeds	[Manual entry] 3	
	Template 2	Same as Output Template 1	
	Template 3		
	Template 4		
	Template 5		
Strings	String	1, 2, 3	
Print Config	Title Config	English, Chinese, None	
	Printer	Others, PQ16	
Reports			
Header	[Manual entry] 2 CR/LF		
Title	Enabled, Disabled		
Record Separator	None, *, -, =, CR/LF		
Footer	[Manual entry] 5 CR/LF		

Parameter	Options	
Connections		
Connections	Port, Assignment, Trigger	
COM1		
Baud	1200,2400, 4800, 9600, 19200, 38400, 57600, 115200	
Data Bits	7, 8	
Parity	None, Odd, Even	
WiFi		
WiFi Account	SSID	[Manual entry]
	Password	[Manual entry]
Ethernet	MAC Address	[Read Only]
	DHCP Client	Disabled, Enabled
	IP Address	[Manual entry]
	Subnet Mask	[Manual entry]
	Gateway Address	[Manual entry]
Print Client	Server IP Addr	[Manual entry] 0,0,0,0
	Server TCP Port	[Manual entry] 8000
Ethernet Mode	Ethernet Mode	Server, Client
WiFi Calibration		
Reset		
Maintenance		
Diagnostics		
Keyboard Test	Key pressed [Displayed value]	
Scale	Load Cell Output	[Displayed value]
	Calibration Value	Zero [Editable value], Test Load #1 [Editable value] kg, Test Load #2 [Editable value] kg, Test Load #3 [Editable value] kg, Test Load #4 [Editable value] kg
	Statistics	Weighments [Displayed value], Overloads [Displayed value], Peak Weight [Displayed value] kg, Zero Commands [Displayed value], Zero Failures [Displayed value]
Serial Test	COM Port	None, COM1
	Sending	
	Receiving	

Parameter	Options
Install SW Update	
Install SW Update	File Name
Backup to SD	
Backup to SD	[Display: "Press START to begin"]
Restore from SD	
Restore Type	Calibration, Calibration & Config
	[Display: "Press START to begin" "Restoring, Please wait!" "Restore file failure!" / "Restore file OK!"]
File Download	
COM Port	None, COM1
File Name	ctemp1.prn, ctemp2.prn, ctemp3.prn, ctemp4.prn, ctemp5.prn, ID1.csv, ID2.csv, ID3.csv
Download Status	"Downloading", "Invalid value"
Reset All	

B Communication

B.1. Demand Output Mode

The demand output mode transmits data only when the terminal receives a print request. Print requests are sent to the IND256x terminal when:

- The operator presses PRINT
- A discrete input selected as print is triggered
- An ASCII "P" is sent through a demand or continuous port
- Auto print is enabled and all conditions for auto print are met
- A print command is sent via shared variable access. NOTE: This does not apply to terminals with Argentina approval.

When triggered, data is transmitted in a string programmed in the output template portion of setup. Demand mode is used typically when sending data to a printer or PC on a transactional basis.

- NOTE: When the demand output mode is assigned, the port is automatically set up to also receive certain ASCII characters to duplicate keypad functions. Refer to the C, T, P, Z section later in this appendix for more details.

B.1.1. Output Templates

The IND256x terminal provides three programmable output templates to define the string of data to be transmitted. Each of the templates is configured in setup and can contain up to 30 fields of data. The same template can be sent to both COM1 and COM2 if both ports are programmed for demand output. It is also possible to send a different data string from the two ports by assigning a different template to each one. The default values for each of the templates follow:

Template 1	
GROSS	18.24 kg
TARE	0.05 kg
NET	18.19 kg

Template 2
18.24 kg, 0.05 kg, 18.19 kg

Template 3
18.23 kg
0.05 kg Tare
18.18 kg NET

B.2. Continuous Output Mode

The IND256x terminal supports the Toledo Continuous Mode for continuous transfer of weight data and status information, for example to a PC or a secondary display. At a baud rate of 2400 and

higher, a data string is transferred approximately 9 times per second. The transfer rate is slower if the baud rate is lower.

B.2.1. Continuous Mode Commands

Command	Use
P	Print the current result
T	Tare the scale
Z	Zero the display
C	Clear the current value
U	Switch the weight unit

B.2.2. Continuous Mode Format

Weight values are always transmitted in the following format:

STX	SB1	SB2	SB3	DF1	DF2	CR	CHK
-----	-----	-----	-----	-----	-----	----	-----

Table B-1: Elements of Continuous Mode Weight Values

Element	Interpretation
STX	ASCII characters 02 hex/2 deci, character for "start of text"
SB1, 2, 3	For status bytes, refer to sections B.2.3, B.2.4 and B.2.5.
DF1	Data field with 6 digits for the weight value (gross or net), transmitted without a decimal point and unit, leading zeroes replaced by blank spaces
DF2	Data field with 6 digits for the tare weight; transmitted without a decimal point and unit. Leading zeroes are replaced by blank spaces
CR	Carriage return (ASCII character 0D hex/13 deci)
CHK	Checksum (2-part complement of binary sum of 7 lower bits of all previously transmitted characters, including STX and CR), transmitted only if activated in the menu

B.2.3. Status Byte SB1

Bit 6	Bit 5	Bit 4	Bit 3	Bit 2	Bit 1	Bit 0
0	1	Rounding/Increment		Decimal Position		

Bit 4	Bit 3	Rounding/Increment
0	1	x1
1	0	x2
1	1	x3

Bit 2	Bit 1	Bit 0	Decimal Position
0	0	0	XXXX00
0	0	1	XXXXX0
0	1	0	XXXXXX
0	1	1	XXXXX.X
1	0	0	XXXX.XX
1	0	1	XXX.XXX

1	1	0	XX.XXXX
1	1	1	X.XXXXX

B.2.4. Status Byte SB2

Bit 6	Bit 5	Bit 4	Bit 3	Bit 2	Bit 1	Bit 0
1	1	0 lb	0 Stability	0 Normal status	0 Positive Sign	Gross value
		1 kg	1 Movement	1 Underload/Overload	1 Negative Sign	Net value

B.2.5. Status Byte SB3

Bit 6	Bit 5	Bit 4	Bit 3	Bit 2	Bit 1	Bit 0
1	1	0 Normal Status	0 Normal status	Weight Unit		
		1 High resolution (x10)	1 Print request			

Bit 2	Bit 1	Bit 0	Weight Unit
0	0	0	kg / lb (SB2 Bit 4)
0	0	1	g
0	1	0	†
0	1	1	oz
1	0	0	oz†
1	0	1	dwt
1	1	0	ton
1	1	1	Free unit

B.3. CTPZ

When a serial port is programmed as a demand, continuous, continuous extended or continuous Multi 1 or Multi2 output, the CTPZ input mode is automatically assigned. The CTPZ input mode provides a method for a remote serial device to trigger several basic functions when a command character is sent to the terminal. A termination character is not required. Remote ASCII command characters include:

- C – Clears the scale to gross
- T – Tares the scale (causes a pushbutton tare)
- P – Initiates a print command

- Z – Zeros the scale

All other characters are ignored. Note that some of the applications have serial commands added. These are described in the application details in the Application chapter.

- ASCII command characters must be sent in upper-case letters.

Example

To initiate a pushbutton tare, program the terminal for demand or continuous output for a specific port, program the serial port parameters to match the other device and then send the ASCII character "T".

B.4. Standard Interface Command Set (SICS) Protocol

The IND256x terminal supports the METTLER TOLEDO Standard Interface Command Set (MT-SICS), which is divided into four levels (0, 1, 2, 3), depending on the functionality of the device. This terminal supports parts of levels 0 and 1:

- MT-SICS level 0 – Command set for the simplest device.
- MT-SICS level 1 – Extension of the command set for standard devices.

A feature of this interface is that the commands combined in MT-SICS level 0 and 1 are identical for all devices. Both the simplest weighing device and a fully expanded weighing workstation can recognize the commands of MT-SICS levels 0 and 1.

B.4.1. Version Number of the MT-SICS

Each level of the MT-SICS has its own version number, which can be requested with the command I1 from level 0. This terminal supports:

- MT-SICS level 0, version 2.2x (except the ZI command)
- MT-SICS level 1, version 2.2x (except the D, DW and K commands)

B.4.2. Command Formats

Each command received by the terminal via the SICS interface is acknowledged by a response to the transmitting device. Commands and responses are data strings with a fixed format. Commands sent to the terminal comprise one or more characters of the ASCII character set. Commands must be in upper-case.

The parameters of the command must be separated from one another and from the command name by a space (20xh), in the examples shown in this section, a space is represented as _).

Each command must be terminated by <CR><LF> (0Dxh, 0Axh).

The characters <CR> and <LF>, which can be input using the **ENTER** or **RETURN** key of most PC terminal keypads, are not shown in this description; however, it is essential they be included for communication with the terminal.

Example

Command to tare the terminal:

"TA_20.00_lb" (The command terminators <CR><LF> are not shown.)

B.4.3. Response Formats

All responses sent by the terminal to the transmitting device acknowledging the received commands have one of the following formats:

Response with weight value

Response without weight value

Error message

B.4.3.1. Format of the Response with Weight Value

A general description of the response with weight value as follows:

ID	___	Status	___	Weight Value	___	Unit	C_R	L_F
1-2		1		10		1-3		
characters		character		characters		characters		

ID – Response identification.

___ – Space (20xh)

Status – Status of the terminal. See description of the commands and responses.

Weight Value – Weighing result, which is shown as a number with 10 digits, including sign directly in front of the first digit. The weight value appears right justified. Preceding zeroes are suppressed with the exception of the zero to the left of the decimal point.

Unit – Weight unit displayed.

CR – Carriage Return (0Dxh.)

LF – Line Feed (0Axh)

Comment

The <CR> and <LF> characters will not be shown in this description.

Example

Response with a stable weight value of 0.256 kg:

S _ S _ _ _ _ _ 0.256 _ kg

B.4.3.2. Format of the Response without Weight Value

A general description of the response without weight value is as follows:

ID	__	Status	__	Parameters	C _R	L _F
1-4		1				
characters		character				

ID – Response identification.

__ – Space (20xh)

Status – Status of the terminal. See description of the commands and responses.

Parameters – Command-dependent response code.

CR – Carriage Return (0Dxh)

LF – Line Feed (0Axh)

Comment – the <CR> and <LF> characters will not be shown in this description.

ID C_R L_F

B.4.3.3. Format of Error Message

There are three different error messages. The identification always comprises two characters:

- ES – Syntax error
The terminal has not recognized the received command.
- ET – Transmission error
The terminal has received a “faulty” command, such as a parity error.
- EL – Logical error
The terminal cannot execute the received command.
- CR – Carriage return (0Dxh)
- LF – Line Feed (0Axh)

Comment

The <CR> and <LF> characters will not be shown in this description.

B.4.4. Tips for the Programmer

Tips for creating a robust communication with the terminal using the SICS protocol include:

B.4.4.1. Command and Response

Improve the dependability of application software by having the program evaluate the response of the terminal to a command. The response is the acknowledgment that the terminal has received the command.

B.4.4.2. Reset

When establishing communication between the terminal and system, send a reset command to the terminal to enable a start from a determined state. When the terminal or system is switched on or off, faulty characters can be received or sent.

B.4.4.3. Quotation Marks (“ ”)

Quotation marks included in the command responses are used to designate fields and will always be sent.

B.4.5. Commands and Responses MT-SICS Level 0

The terminal receives a command from the system computer and acknowledges the command with an appropriate response. The following sections contain a detailed description of the command set in alphabetical order with the associated responses. Commands and responses are terminated with <CR> and <LF>. These termination characters are not shown in the following description, but they must always be entered with commands or sent with responses.

The following commands of MT-SICS level 0 are supported:

IO	Inquiry of all implemented MT-SICS commands
I1	Inquiry of MT-SICS level and MT-SICS versions
I2	Inquiry of balance data
I3	Inquiry of balance SW version and type definition number
I4	Inquiry of serial number
S	Send stable weight value
SI	Send weight value immediately
SIR	Send weight value immediately and repeat
Z	Zero
@	Reset (clear out serial buffer)

The following are detailed descriptions of these Level 0 commands:

B.4.5.1. IO – INQUIRY OF ALL IMPLEMENTED MT-SICS COMMANDS

Command:	IO
Response:	IO_B_0_“IO” Level 0 “IO” command implemented
	IO_B_0_“I1” Level 0 “I1” command implemented
	IO_B_0_“I2” Level 0 “I2” command implemented
	IO_B_0_“I3” Level 0 “I3” command implemented
	IO_B_0_“I4” Level 0 “I4” command implemented
	IO_B_0_“S” Level 0 “S” command implemented
	IO_B_0_“SI” Level 0 “SI” command implemented
	IO_B_0_“SIR” Level 0 “SIR” command implemented
	IO_B_0_“Z” Level 0 “Z” command implemented
	IO_B_0_“@” Level 0 “@” command implemented
	IO_B_0_“SR” Level 1 “SR” command implemented
	IO_B_0_“T” Level 1 “T” command implemented
	IO_B_0_“TA” Level 1 “TA” command implemented
	IO_B_0_“TAC” Level 1 “TAC” command implemented
Response:	IO_A_1_“TI” Level 1 “TI” command implemented (last command)

Response: IO_I Cannot execute command at this time.

B.4.5.2. I1 – INQUIRY OF MT-SICS LEVEL AND MT-SICS VERSIONS

Command: I1

Response: I1_A_""_2.2x_2.2x_""_""_""
 "" No Levels fully implemented
 2.2x Level 0, version V2.2x
 2.2x Level 1, version V2.2x
 "" No MT-SICS 2 commands
 "" No MT-SICS 3 commands

Response: I1_I Command understood, not executable at present.

Comments

- For the MT-SICS level, only fully implemented levels are listed. In this case, neither level 0 nor level 1 were fully implemented so the level is not specified.
- In the case of the MT-SICS version, all levels are specified even those only partially implemented.

B.4.5.3. I2 – INQUIRY OF DATA

Command: I2

Response: I2_A_“IND246_Standard_50.00_kg”
 IND246 Model number of terminal
 Standard Standard functionality
 50.00 kg Capacity and primary unit of the scale

Response: I2_I Command understood, not executable at present.

Comments

- The number of characters in the “text” field depends on the scale capacity.

B.4.5.4. I3 – INQUIRY OF SW VERSION

Command: I3

Response: I3_A_“1.00”
 1.00 Firmware version of the terminal

Response: I3_I Command understood, not executable at present.

Comment

- The number of characters of “text” depends on the revision level.

B.4.5.5. I4 – INQUIRY OF SERIAL NUMBER

Command: I4

Response: I4_A_“123456”

123456 Serial number of terminal

Response: I4_I Command understood, not executable at present.

Comments

- The serial number response is the content of the terminal serial number variable (#301) as entered in setup.

B.4.5.6. S – SEND STABLE WEIGHT VALUE

Command: S

Response: S_S_ _ _ _ _ 436.2_lb

436.2 stable displayed weight

lb weight unit

Response: S_I Command understood, not executable at present.

Response: S_+ Terminal in overload range.

Response: S_- Terminal in underload range.

Comments

- The terminal will wait for up to 3 seconds after receiving an “S” command for no-motion. If motion does not settle within this time, the command is aborted and the S_I response is sent.

B.4.5.7. SI – SEND WEIGHT VALUE IMMEDIATELY

Command: SI

Response: S_S_ _ _ _ _ 436.2_lb Stable weight value.

Response: S_D_ _ _ _ _ 436.2_lb Non-stable (dynamic) weight value.

Response: S_I Command understood, not executable at present.

Response: S_+ Terminal in overload range.

Response: S_- Terminal in underload range.

Comments

- The response to the command SI is the last internal weight value (stable or dynamic) before receipt of the “SI” command.

B.4.5.8. SIR – SEND WEIGHT VALUE IMMEDIATELY AND REPEAT

Command: SIR

Response: S_S_ _ _ _ _ 436.2_lb Stable weight value.

Response: S_D_ _ _ _ _ 436.2_lb Non-stable (dynamic) weight value.
 Response: S_I Command understood, not executable at present.
 Response: S_+ Terminal in overload range.
 Response: S_- Terminal in underload range

Example

Command: SIR
 Response: S_D_ _ _ _ _ 129.07_kg
 S_D_ _ _ _ _ 129.09_kg
 S_S_ _ _ _ _ 129.09_kg
 S_S_ _ _ _ _ 129.09_kg
 S_D_ _ _ _ _ 114.87_kg
 ... The scale continues to send stable or dynamic weight values

Comments

- The SIR command is overwritten and cancelled by the commands S, SI, SR, and @.
- The data output rate is approximately 4 per second.

B.4.5.9.

Z – ZERO

Command: Z
 Response: Z_A Command performed, meaning the scale was in gross mode, scale was stable and weight was within the zero capture range.
 Response: Z_I Command understood, not executable at present.
 Response: Z_+ Upper limit of zero setting range exceeded.
 Response: Z_- Lower limit of zero setting range exceeded.

Comments

- The calibrated zero point determined during calibration is not influenced by this command.
- The terminal will wait for up to 3 seconds after receiving an “Z” command for no-motion. If motion does not settle within this time, the command is aborted and the Z_I response is sent.

B.4.5.10.

@ – RESET

Command: @
 Response: I4_A_“12345678”
 12345678 Serial number of the scale

Comments

- Resets the scale to the condition found after switching on, but without a zero setting being performed.
- All commands awaiting responses are canceled.
- The tare register is cleared.
- The SIR and SR commands are cancelled.
- The Reset command is always executed except that a Reset command received by the terminal during the calibration and test procedure cannot be processed.

B.4.6. Commands and Responses MT-SICS Level 1

The following commands of MT-SICS level 1 are available:

SR	Send weight value on weight change (Send and Repeat)
T	Tare
TA	Set or inquiry of preset tare value
TAC	Clear tare value
TI	Tare Immediately

B.4.6.1. SR – SEND WEIGHT VALUE ON WEIGHT CHANGE (SEND AND REPEAT)

Command: SR_Value_Unit

SR

Response: S_S_ _ _ _ _ 105.1_lb Current stable weight.

S_D_ _ _ _ _ 106.7_lb Dynamic weight value.

S_S_ _ _ _ _ 124.3_lb Next stable weight value.

Response: S_I Command understood, not executable at present.

Response: S_L Command understood, invalid parameter.

Response: S_+ Terminal in overload range.

Response: S_- Terminal in underload range.

Example

Command: SR_0.50_kg Send the current stable weight value followed by every load change ≥ 0.50 kg.

Response: S_S_ _ _ _ _ 100.00_kg Scale stable.

S_D_ _ _ _ _ 115.23_kg More than 0.50 kg loaded.

S_S_ _ _ _ _ 200.00_kg Scale stable again.

Comments

- Command to send the current stable weight once then continuously after every weight change greater or equal to the “value” a non-stable (dynamic) value followed by the next stable value. If no preset value is included, the weight change must be at least 12.5% of the last stable weight value an a minimum of 30d.
- SR is overwritten and cancelled by the commands S, SI, SIR, @ and hardware break.
- If, following a non-stable (dynamic) weight value, stability has not been reached within the 3 second timeout interval, the response “S_I ” is sent and then a non-stable weight value. Timeout then starts again form the beginning.
- The range value must be entered in primary units and must be in the range of 1d to capacity.

B.4.6.2.

T – TARE

Command: T

Response: T_S_ _ _ _100.00_kg Tare performed, meaning the scale was stable and weight was within the weighing range.

Response: T_I Command understood, not executable at present.

Response: T_+ Upper limit of zero setting range exceeded.

Response: T_- Lower limit of zero setting range exceeded.

Comments

- The existing tare will be overwritten and replaced by the new preset tare weight value.
- The terminal will wait for up to 3 seconds after receiving a “T” command for no-motion. If motion does not settle within this time, the command is aborted and the T_I response is sent.

B.4.6.3.

TA – INQUIRE/ENTER TARE VALUE

Command: TA Inquiry of tare weight value

TA_Tare Preset Value_Unit Entry of a preset tare value.

Response: TA_A_TareWeightValue_Unit Current Tare weight value.

Response: TA_I Current Tare weight value cannot be transferred (the terminal is currently executing another command, such as zero setting).

Response: TA_L Command understood, invalid parameter.

Example

Command: TA_10.00_kg Load a preset tare of 10 kg.

Response: TA_A_ _ _ _10.00_kg The 10.00 kg tare value was accepted.

Comments

- The existing tare will be overwritten and replaced by the new preset tare weight value.
- The terminal will automatically round the tare value to the current readability.

- The preset value must be entered in primary units.

B.4.6.4. TAC – CLEAR TARE VALUE

Command: TAC

Response: TAC_A Tare value cleared.

Response: TAC_I Command understood, not executable at present.

B.4.6.5. TI – TARE IMMEDIATELY

Command: TI

Response: TI_S_WeightValue_Unit Taring performed, stable tare value.

Response: TI_D_WeightValue_Unit Taring performed, non-stable (dynamic) tare value.

Response: TI_I Command understood, not executable at present.

Response: TI_L The command is not executable.

Response: TI_+ Upper limit of taring range exceeded.

Response: TI_- Lower limit of taring range exceeded.

Example

Command: TI

Response: TI_D_ _ _ _ 117.57_kg Tare taken with dynamic weight value.

Comments

- Any previous tare value will be overwritten by the new tare weight value.
- Tare weight values determined during motion may not be accurate.
- The tare weight value is sent in the current units.

B.5. Reports

In order to print reports, a connection must be made for the “Reports” function. When a reports connection is made to a serial port, whenever a report is run and then printed, it will be routed to the assigned port.

The line width of the printed report is 80 characters. This format is fixed and cannot be changed. A title and a footer consisting of additional line feeds and the record separator character are also selected in the Reports sub-block of Communications.

A sample of the Alibi memory and totalization register reports in an 80 column wide print are shown in the following sections.

B.5.1. Alibi Memory

The alibi memory can be viewed and printed. Alibi memory is viewed by selecting the ALIBI icon **Alibi**. A search screen is shown that can help reduce the number of records retrieved to a manageable level.

After entering the desired search criteria, move focus to the START text and press ENTER. The Alibi memory report will be run and the first record will be shown on the display. Move through the results using the UP and DOWN navigation keys. There is a scroll bar indicator on the right of the display to indicate where in the search results the currently displayed record is positioned.

Pressing PRINT with any record shown will initiate a transmission of the results from the port programmed as Reports. An example is shown in Figure B-1.

Alibi Memory Report					
08:35:45 04/Jul/2018					
22-Jun-2018	13:45:22	00000024	23561 kg N	0 kg T	23561 kg
22-Jun-2018	13:45:45	00000025	23563 kg N	0 kg T	23563 kg
04-Jul-2018	08:06:29	00000026	27 kg N	0 kg T	27 kg
04-Jul-2018	08:06:32	00000027	28 kg N	0 kg T	28 kg
04-Jul-2018	08:25:55	00000028	27 kg N	0 kg T	27 kg
04-Jul-2018	08:25:58	00000029	27 kg N	0 kg T	27 kg
04-Jul-2018	08:26:16	00000030	27 kg N	0 kg T	27 kg
04-Jul-2018	08:26:17	00000031	28 kg N	0 kg T	28 kg
04-Jul-2018	08:26:18	00000032	27 kg N	0 kg T	27 kg
04-Jul-2018	08:27:56	00000033	31 kg N	0 kg T	31 kg
04-Jul-2018	08:27:57	00000034	31 kg N	0 kg T	31 kg

Figure B-1: 80 Column Alibi Memory Print Example

B.5.2. Totals Report

The totals report will print only the fields that have been enabled for the totalizing function. If the subtotal feature has been disabled, then that field will not display or print. The example in Figure B-2 below includes both the subtotal and grand total fields.

Totals Report			
Time:	09:01:33	Date:	04/Jul/2018

SubTotal	n = 8	3519	kg

GrandTotal	n = 8	3519	kg

Figure B-2: Totals Report Sample

B.5.3. Transaction Log Report

The transaction log report can be viewed and printed. To reduce the number of records retrieved to a manageable level, use the SEARCH icon and enter the desired search criteria. Press START. The

transaction log report will be run and the first record will be shown on the display. Move through the results using the UP and DOWN navigation keys. A scroll bar indicator on the right of the display indicates where in the search results the currently displayed record is positioned.

Pressing PRINT with any record shown will initiate a transmission of the results out the port programmed as Reports. An example is shown in Figure B-3.

Transaction Table Report							
19-Jun-2018	13:54:45	00000022	20631 kg N	0 kg T	20631 kg	Scale 1	123456 ABCGHI
22-Jun-2018	13:45:22	00000023	23561 kg N	0 kg T	23561 kg	Scale 1	1001 ABCGHI
22-Jun-2018	15:35:45	00000024	23563 kg N	0 kg T	23563 kg	Scale 1	1001 ABCGHI
04-Jul-2018	08:06:29	00000025	27 kg N	0 kg T	27 kg	Scale	1001 ABCGHI
04-Jul-2018	08:06:32	00000026	28 kg N	0 kg T	28 kg	Scale	1001 ABCGHI
04-Jul-2018	08:06:32	00000027	28 kg N	0 kg T	28 kg	Scale	1001 ABCGHI
04-Jul-2018	08:29:56	00000028	32 kg N	0 kg T	32 kg	Scale	1001 ABCGHI
04-Jul-2018	08:29:57	00000029	31 kg N	0 kg T	31 kg	Scale	1001 ABCGHI
04-Jul-2018	08:54:46	00000030	769 kg N	0 kg T	769 kg	Scale	1001 ABCGHI

Figure B-3: Transaction Log Report Print Example

B.5.4. Target Table

The target table will print only the fields that have been edited in the table. If you want to display and print total and count, Totalization must be enabled and the Clear Totalization must be selected. The example in Figure B-4 below includes both the total and count fields.

TARGET TABLE									
Target	ID	Description	Target	Unit	Tolerance-	Tolerance+	Total	Count	
1	PQ	100	kg	0	0	0	0		
2	AB	30	kg	0	0	0	0		
3	EF	250	kg	0	0	0	0		
10	PQR	500	kg	1	1	0	0		

Figure B-4: Target Table Print Example

B.6. Label Design and Printing

B.6.1. Preparation

The following are required:

- A PC with an USB interface.
- A SD card reader.
- An IND256X electronic counting scale
- An IND256X Terminal
- A label printer.

- A RS232 serial cable

B.6.2. Set the Printer Template

To meet users' changing needs, IND256x terminals use custom templates to output data in a custom format.

B.6.2.1. Predefined Strings

The IND245x can provide Gross, Net, Tare, Time, and various other data outputs. The user specifies the required data in a custom template by using a conditional string.

These conditional strings tell the terminal which data to output. Each string consists of three parts: prefixes, a string label, and suffixes. The prefix and suffix characters are all "\$\$", two consecutive dollar signs.

Available strings are listed in Table B-2, together with the data to which they refer.

Table B-2: Conditional Strings Relevant to Terminal Data

String	Corresponding Terminal Data
\$\$ID1INDEX\$\$	Field 1 in ID1 table
\$\$ID2INDEX\$\$	Field 1 in ID2 table
\$\$ID3INDEX\$\$	Field 1 in ID3 table
\$\$ID1DESC\$\$	Field 2 in ID1 table
\$\$ID2DESC\$\$	Field 2 in ID2 table
\$\$ID3DESC\$\$	Field 2 in ID3 table
\$\$DISPLAY\$\$	Displaying Weight
\$\$GROSS\$\$	Gross
\$\$NET\$\$	Net
\$\$TARE\$\$	Tare
\$\$UNIT\$\$	Unit
\$\$T TYPE\$\$	Type of Tare
\$\$DATE\$\$	Date
\$\$TIME\$\$	Time
\$\$SCALENA\$\$	Scale Name
\$\$TRANSID\$\$	Transaction ID
\$\$G/N\$\$	G/N
\$\$TOTAL\$\$	Total Value
\$\$SUBTOTAL\$\$	Subtotal
\$\$TOLCOUNT\$\$	Total Count
\$\$SUBCOUNT\$\$	Subcount

String	Corresponding Terminal Data
\$\$TRANSDSC\$\$	Description of Transaction
\$\$TARGETVAL\$\$	Target Value
\$\$TARGET-\$\$	Target-
\$\$TARGET+\$\$	Target +
\$\$STARTYPE\$\$	Type of Target
\$\$STARID\$\$	Target ID
\$\$STARTOTAL\$\$	Total Target
\$\$STARCOUNT\$\$	Target Count
\$\$RESULT\$\$	Result
\$\$STRING1\$\$	String 1
\$\$STRING2\$\$	String 2
\$\$STRING3\$\$	String 3

B.6.3. Template Editing Software

The IND256x terminal supports many kinds of label printer. In the sections below, ZebraDesigner software is used to provide an example of creating and using a label-printing template.

B.6.3.1. Installing GT800 (ZPL) Driver Programs

Install the ZPL driver programs from the program disc.

B.6.3.2. Installing Template Design Software

Install the ZebraDesigner software on PC (e.g., from a disc, or by download from the Zebra official website).

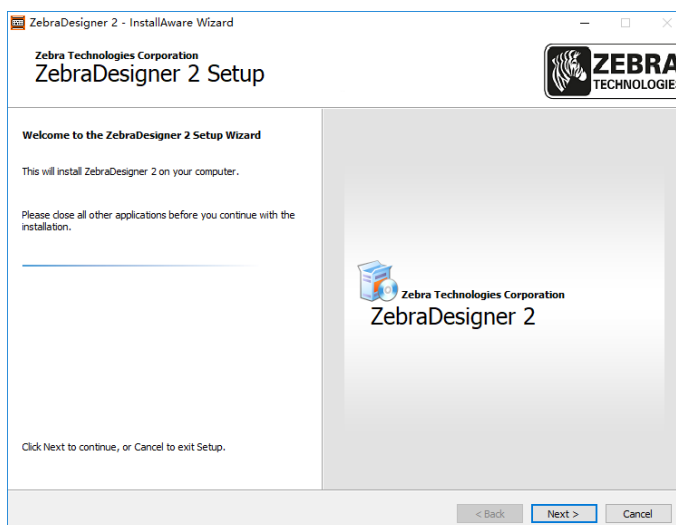

Figure B-5: ZebraDesigner Setup Wizard

B.6.3.3. Starting up label design program

Double click the icon on the desktop to run the label design program.

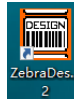

Figure B-6: ZebraDesigner Desktop Icon

Select 'Create a new label' (or open a recently used label), and click 'Finish'.

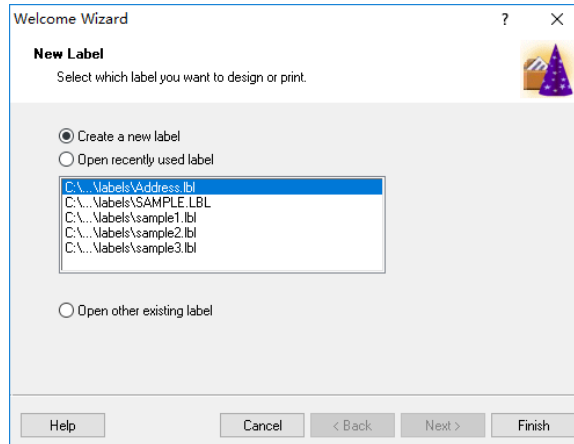

Figure B-7: New Label Creation Dialog

The label design process includes a number of steps, including

- Selecting a printer
- Defining, or selecting, a label stock
- Selecting label orientation

Defining label dimensions

B.6.3.3.1. Printer Selection

Select the correct printer and click Properties, or click Next to select a paper size from the predefined label formats list.

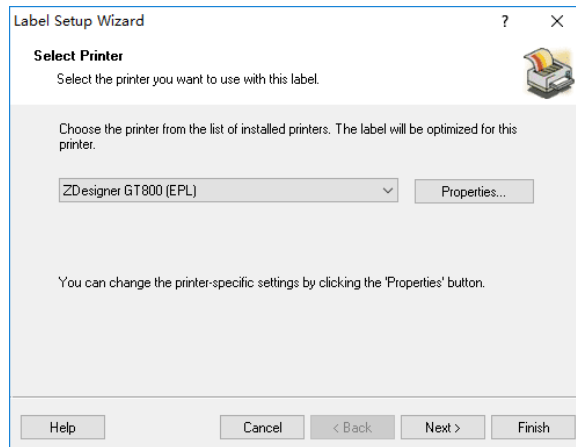

Figure B-8: Printer Selection Dialog

B.6.3.3.2. Setting Label Size

Defining a Custom Label

Specify the label's width and height based on the label in use; when defining a custom size, select None in the Stock size list. Click OK after these settings are completed.

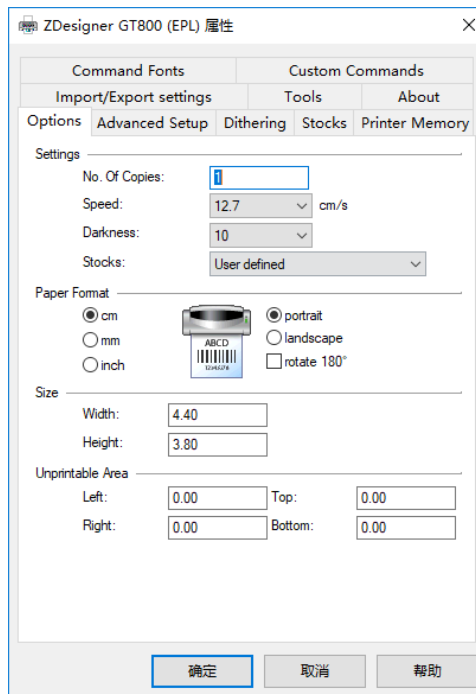

Figure B-9: Label Size and Format Options Dialog

Click Finish when settings are complete.

Using a Stock Label

Alternatively, use a predefined stock size:

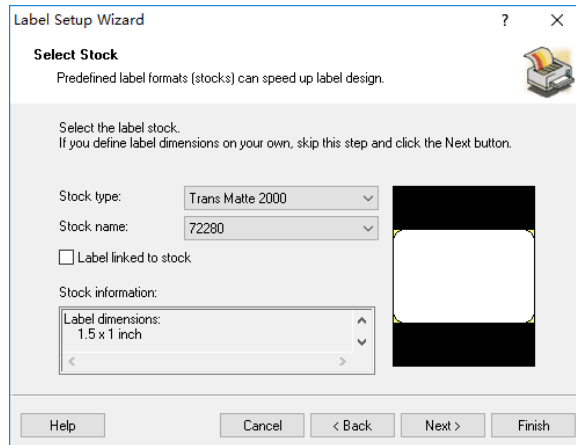

Figure B-10: Label Setup Wizard: Select Stock

Click Next. Now set the page size by checking Automatically set from label dimensions, and click Next.

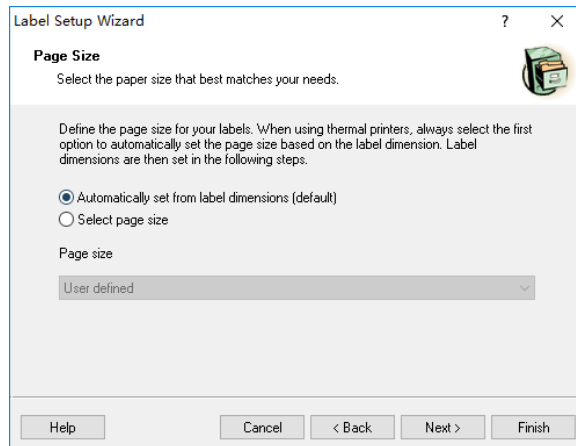

Figure B-11: Label Setup Wizard: Page Size

Finally, define the layout of the label based on the options provided in the next screen:

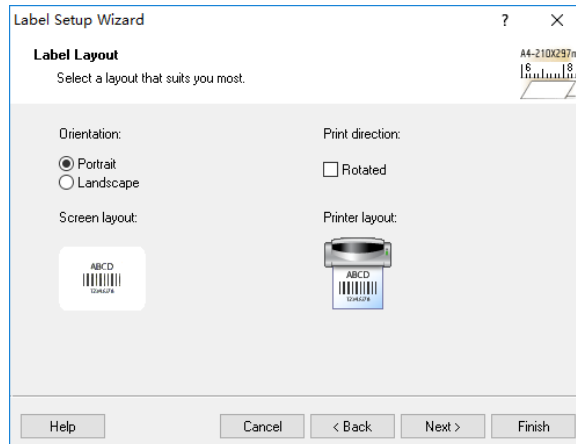

Figure B-12: Label Setup Wizard: Label Layout

Check and set the parameters. Click Finish when completed.

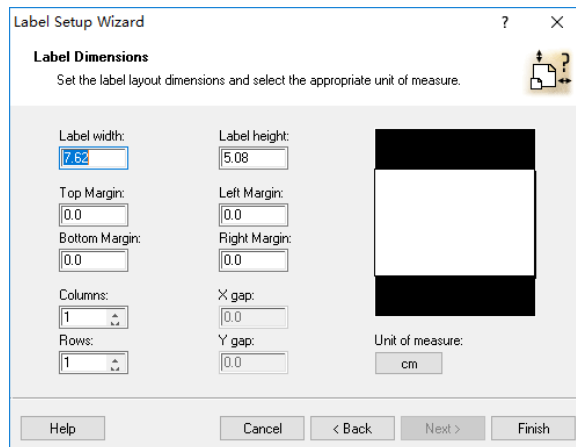

Figure B-13: Label Setup Wizard: Label Dimensions

Click Finish to complete the setup process.

B.6.3.3.3. Designing a Label

The next figure shows the ZebraDesigner design window with an example label design. Its components are indicated, and described below.

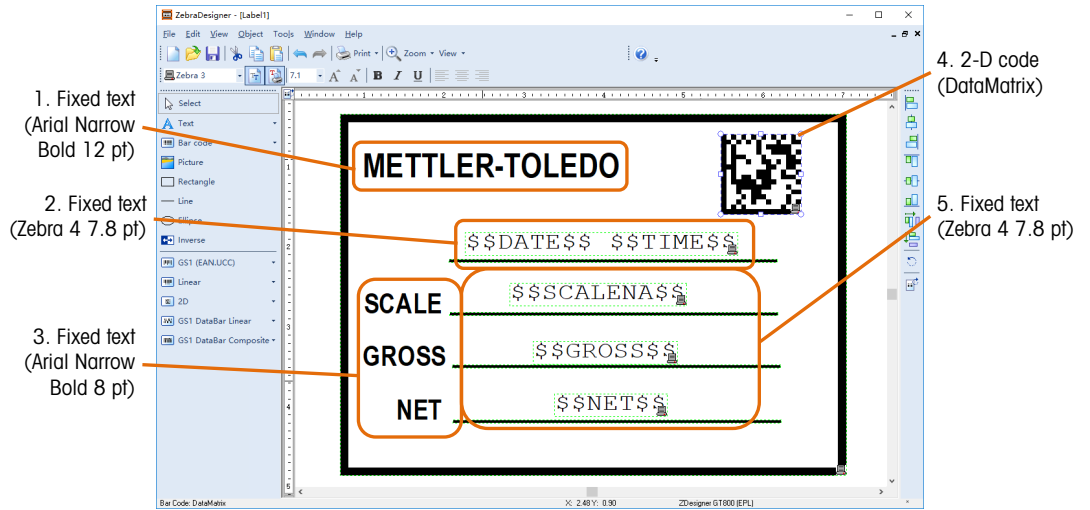

Figure B-14: Elements of a Sample Label

Items 1 and 3: Click Text in the left pane of the design window. Move the mouse cursor to the point where you wish to place the text, and left-click. Enter the fixed text in the screen that appears, and click Finish.

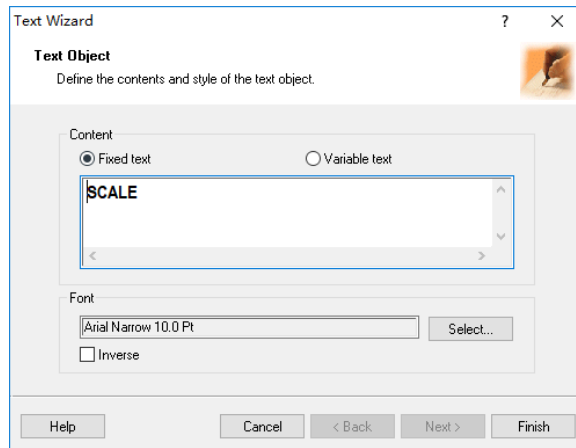

Figure B-15: Fixed Text Entry

Items 2 and 5: These four items contain conditional strings. As before, click Text, position the cursor to locate the text, left-click, then enter the desired string (selected from the list provided in Table B-2) in the dialog that appears.

- Note that conditional strings are case-sensitive, and must be entered exactly as shown in Table B-2.

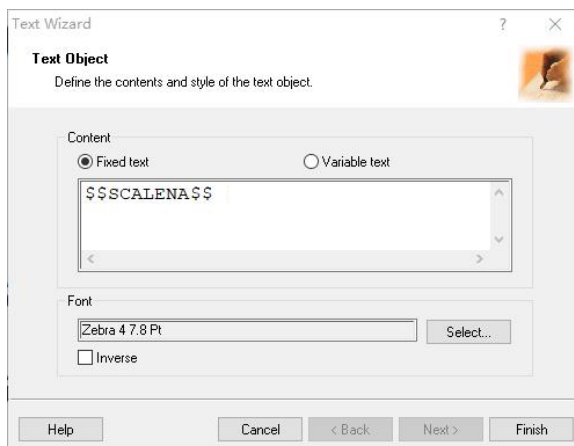

Figure B-16: Conditional Text Entry

- Note: The current font must be Zebra x.

Item 4: This item will be used to create a barcode, in this case set to show the transaction ID. Click 2D in the left pane of the design window, place the cursor where the code should appear, and left-click. From the Bar Code Type drop-down box, choose DataMatrix, then enter the \$\$TRANSID\$\$ conditional string.

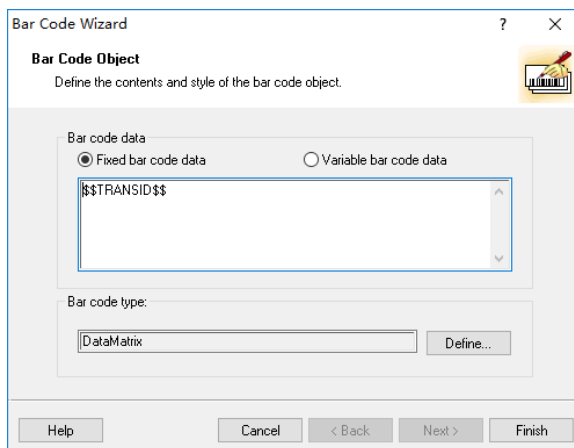

Figure B-17: Defining a Bar Code Object

B.6.3.4. Generating a Print Template

When the label design is complete, click Print in the menu bar of the screen shown in Figure B-14. Configure the print dialogue as shown below:

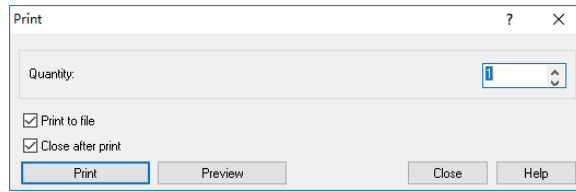

Figure B-18: Print Dialog

Press Print, and save the template as a .prn file. The template must be named ctemp1.prn, ctemp2.prn, ctemp3.prn, ctemp4.prn, or ctemp5.prn, which will link to Templates 1 to 5, respectively, in the terminal. The terminal will not be able to recognize the templates if they are incorrectly named.

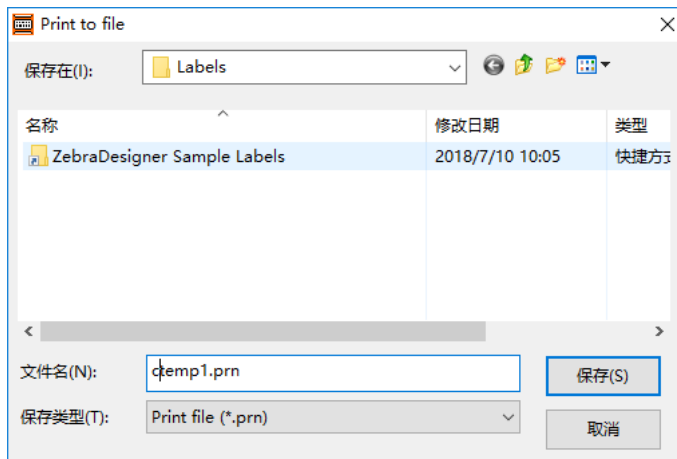

Figure B-19: Creating the .prn File

Now, when the template is used it will create a label which reads current values from the printer and includes them in place of the conditional strings.

B.6.3.5. Uploading the Template to the Terminal

1. Open the terminal and carefully remove the SD card from its slot.
2. Insert the SD card into a card reader connected to the PC used to design the label.



Figure B-20: SD to PC Transfer

- Copy the printer template generated above to the template folder on the SD card. Templates 1 to 5 link to the template documents ctemp1.prn, ctemp2.prn, ctemp3.prn, ctemp4.prn, and ctemp5.prn, respectively, created in section B.6.3.4.
- Reinstall the SD card in terminal.

B.6.4. Setting the Printer Template

- Apply power to the terminal and, once it has booted, enter setup, using a supervisor-level login, and access Communication.



Figure B-21: Communication Menu

- Access Communication | Connections. From the Connections list, select the port to be configured and click EDIT .



Figure B-22: Connections List

- Configure the connection use the scale as its trigger, and select the desired template.



Figure B-23: Connections Edit Screens

- At Communication | Templates | Output | Template1, set the Type to Label Print.

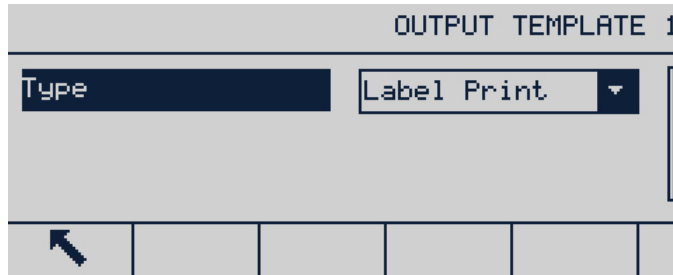

Figure B-24: Output Template Type Selection

- At Communication I Print Config, set the printer type to Others.

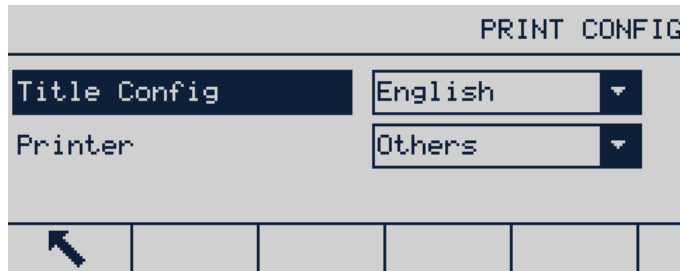

Figure B-25: Printer Configuration Screen

- Access Communication I COM1 and check that the GT800 printer communication parameters are as shown in Figure B-26.

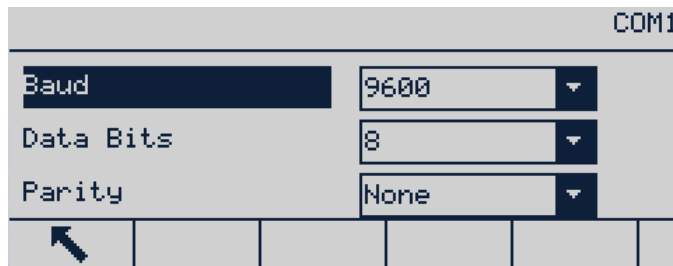



Figure B-26: COM1 Configuration Screen

- Exit setup.

Now, pressing the PRINT key  on the printer's front panel will print a label using current scale data and formatted according to the selected template.

C GEO Codes

The GEO code feature provided in the IND256x terminal permits calibration readjustment due to changes in elevation or latitude without reapplying test weights. This adjustment assumes a previously accurate calibration was done with the GEO code set properly for that original location and that the GEO code for the new location can be accurately determined. The procedure for using this feature is as follows.

C.1. Original Site Calibration

1. Use the GEO code chart (Table C-1) on the following pages to determine the GEO code for the current altitude and location at which the scale will be calibrated.
2. Enter that GEO value into the GEO code parameter in setup at Scale > Calibration.
3. Immediately after entering the GEO code, perform a zero and span adjustment using accurate test weights.
4. Exit the setup menu tree.
5. The scale can now be used in its new location.

C.2. New Site GEO Code Adjustment

When a terminal is to be reinstalled at a different geographic location, gravitational and altitude changes can be accounted for by following these steps. Note that this procedure is not necessary if an on-site recalibration is performed.

1. Use the GEO code chart (Table C-1) on the following pages to determine the GEO code for the new altitude and location at which the scale will be used.
2. Enter that GEO value into the GEO code parameter in Setup at Scale > Calibration.
3. Immediately after entering the GEO code, exit the setup menu tree. DO NOT perform a normal calibration.

The calibration has now been adjusted for the differences in gravity from the original site of calibration to the new site of use.

- Using the GEO code value for calibration adjustment is not as accurate as re-applying certified test weights and re-calibrating the scale in a new location.

Table C-1: GEO Adjustment Values

Latitude North or South, in Degrees and Minutes	Height Above Sea Level, in Meters										
	0	325	650	975	1300	1625	1950	2275	2600	2925	3250
	325	650	975	1300	1625	1950	2275	2600	2925	3250	3575
	Height Above Sea Level, in Feet										
	0	1060	2130	3200	4260	5330	6400	7460	8530	9600	10660
1060	2130	3200	4260	5330	6400	7460	8530	9600	10660	11730	
0° 0'–5° 46'	5	4	4	3	3	2	2	1	1	0	0
5° 46'–9° 52'	5	5	4	4	3	3	2	2	1	1	0
9° 52'–12° 44'	6	5	5	4	4	3	3	2	2	1	1
12° 44'–15° 6'	6	6	5	5	4	4	3	3	2	2	1
15° 6'–17° 0'	7	6	6	5	5	4	4	3	3	2	2
17° 10'–19° 2'	7	7	6	6	5	5	4	4	3	3	2
19° 2'–20° 45'	8	7	7	6	6	5	5	4	4	3	3
20° 45'–22° 22'	8	8	7	7	6	6	5	5	4	4	3
22° 22'–23° 54'	9	8	8	7	7	6	6	5	5	4	4
23° 54'–25° 21'	9	9	8	8	7	7	6	6	5	5	4
25° 21'–26° 45'	10	9	9	8	8	7	7	6	6	5	5
26° 45'–28° 6'	10	10	9	9	8	8	7	7	6	6	5
28° 6'–29° 25'	11	10	10	9	9	8	8	7	7	6	6
29° 25'–30° 41'	11	11	10	10	9	9	8	8	7	7	6
30° 41'–31° 56'	12	11	11	10	10	9	9	8	8	7	7
31° 56'–33° 9'	12	12	11	11	10	10	9	9	8	8	7
33° 9'–34° 21'	13	12	12	11	11	10	10	9	9	8	8
34° 21'–35° 31'	13	13	12	12	11	11	10	10	9	9	8
35° 31'–36° 41'	14	13	13	12	12	11	11	10	10	9	9
36° 41'–37° 50'	14	14	13	13	12	12	11	11	10	10	9
37° 50'–38° 58'	15	14	14	13	13	12	12	11	11	10	10
38° 58'–40° 5'	15	15	14	14	13	13	12	12	11	11	10
40° 5'–41° 12'	16	15	15	14	14	13	13	12	12	11	11
41° 12'–42° 19'	16	16	15	15	14	14	13	13	12	12	11
42° 19'–43° 26'	17	16	16	15	15	14	14	13	13	12	12
43° 26'–44° 32'	17	17	16	16	15	15	14	14	13	13	12
44° 32'–45° 38'	18	17	17	16	16	15	15	14	14	13	13

Latitude North or South, in Degrees and Minutes	Height Above Sea Level, in Meters										
	0	325	650	975	1300	1625	1950	2275	2600	2925	3250
	325	650	975	1300	1625	1950	2275	2600	2925	3250	3575
	Height Above Sea Level, in Feet										
	0	1060	2130	3200	4260	5330	6400	7460	8530	9600	10660
1060	2130	3200	4260	5330	6400	7460	8530	9600	10660	11730	
45° 38'–46° 45'	18	18	17	17	16	16	15	15	14	14	13
46° 45'–47° 51'	19	18	18	17	17	16	16	15	15	14	14
47° 51'–48° 58'	19	19	18	18	17	17	16	16	15	15	14
48° 58'–50° 6'	20	19	19	18	18	17	17	16	16	15	15
50° 6'–51° 13'	20	20	19	19	18	18	17	17	16	16	15
51° 13'–52° 22'	21	20	20	19	19	18	18	17	17	16	16
52° 22'–53° 31'	21	21	20	20	19	19	18	18	17	17	16
53° 31'–54° 41'	22	21	21	20	20	19	19	18	18	17	17
54° 41'–55° 52'	22	22	21	21	20	20	19	19	18	18	17
55° 52'–57° 4'	23	22	22	21	21	20	20	19	19	18	18
57° 4'–58° 17'	23	23	22	22	21	21	20	20	19	19	18
58° 17'–59° 32'	24	23	23	22	22	21	21	20	20	19	19
59° 32'–60° 49'	24	24	23	23	22	22	21	21	20	20	19
60° 49'–62° 9'	25	24	24	23	23	22	22	21	21	20	20
62° 9'–63° 30'	25	25	24	24	23	23	22	22	21	21	20
63° 30'–64° 55'	26	25	25	24	24	23	23	22	22	21	21
64° 55'–66° 24'	26	26	25	25	24	24	23	23	22	22	21
66° 24'–67° 57'	27	26	26	25	25	24	24	23	23	22	22
67° 57'–69° 35'	27	27	26	26	25	25	24	24	23	23	22
69° 5'–71° 21'	28	27	27	26	26	25	25	24	24	23	23
71° 21'–73° 16'	28	28	27	27	26	26	25	25	24	24	23
73° 16'–75° 24'	29	28	28	27	27	26	26	25	25	24	24
75° 24'–77° 52'	29	29	28	28	27	27	26	26	25	25	24
77° 52'–80° 56'	30	29	29	28	28	27	27	26	26	25	25
80° 56'–85° 45'	30	30	29	29	28	28	27	27	26	26	25
85° 45'–90° 00'	31	30	30	29	29	28	28	27	27	26	26

METTLER TOLEDO Service

To protect your product's future:

Congratulations on choosing the quality and precision of METTLER TOLEDO. Proper use according to these instructions and regular calibration and maintenance by our factory-trained service team ensure dependable and accurate operation, protecting your investment. Contact us about a service agreement tailored to your needs and budget.

We invite you to register your product at www.mt.com/productregistration so we can contact you about enhancements, updates and important notifications concerning your product.

www.mt.com/IND256x

For more information

Mettler-Toledo, LLC
1900 Polaris Parkway
Columbus, OH 43240

© 2022 Mettler-Toledo, LLC
30491440 Rev. 09, 09/2022



30491440