

METTLER TOLEDO
Weighing terminal IND429
Weighing terminal IND429xx
Compact scales BBA429

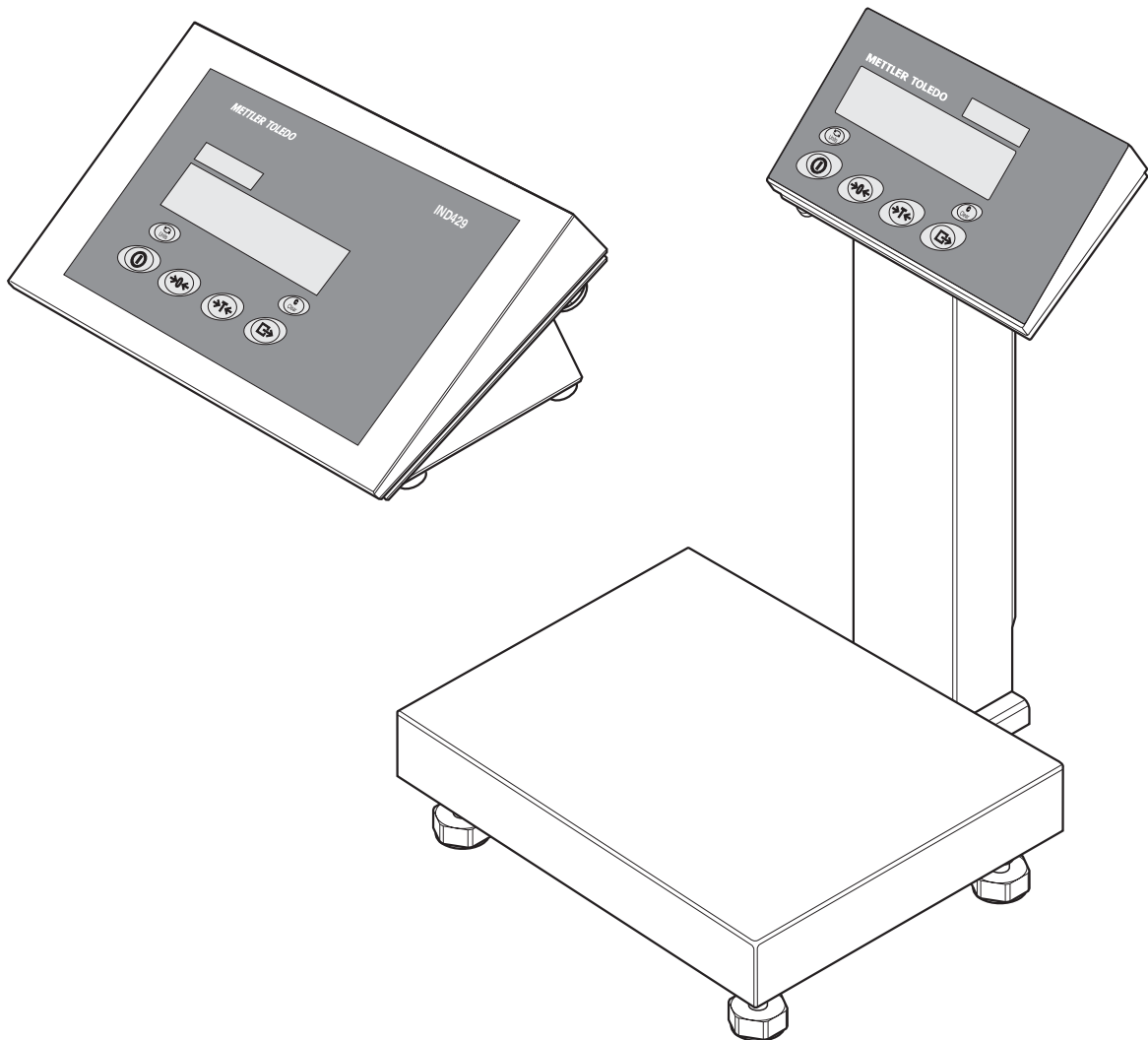



Congratulations on choosing the quality and precision of METTLER TOLEDO. Proper use according to this Operating Manual and regular calibration and maintenance by our factory-trained service team ensures dependable and accurate operation, protecting your investment. Contact us about a ServiceXXL agreement tailored to your needs and budget.

We invite you to register your product at www.mt.com/productregistration so we can contact you about enhancements, updates and important notifications concerning your product.

Table of contents

| | Page |
|----------|---|
| 1 | Introduction5 |
| 1.1 | Safety instructions for the explosion protected weighing terminal IND429xx5 |
| 1.2 | Safety instructions for non-explosion-protected devices6 |
| 1.3 | Disposal7 |
| 1.4 | Use in hygienically sensitive areas7 |
| 1.5 | Description8 |
| 1.6 | Commissioning12 |
| 2 | Operation15 |
| 2.1 | Switching on and off15 |
| 2.2 | Zeroing / Zero point correction15 |
| 2.3 | Simple weighing15 |
| 2.4 | Weighing with tare16 |
| 2.5 | Dynamic weighing17 |
| 2.6 | Printing results18 |
| 2.7 | Cleaning18 |
| 2.8 | Testing of weighing terminal and scale/display of the ID code (only for weighing terminals with IDNet interface)19 |
| 3 | Settings in the menu20 |
| 3.1 | Operating the menu20 |
| 3.2 | Overview22 |
| 3.3 | Scale settings (SCALE) – analog25 |
| 3.4 | Scale settings (SCALE) – IDNet27 |
| 3.5 | Application settings (APPLICATION)29 |
| 3.6 | Terminal settings (TERMINAL)29 |
| 3.7 | Configuring interfaces (COMMUNICATION)30 |
| 3.8 | Diagnosis and printing out of the menu settings (DIAGNOS)34 |
| 4 | Interface description35 |
| 4.1 | SICS interface commands35 |
| 4.2 | TOLEDO Continuous mode37 |
| 4.3 | MMR interface commands39 |
| 5 | Event and error messages42 |
| 6 | Technical data and accessories44 |
| 6.1 | Technical data44 |
| 6.2 | Accessories48 |

| | | |
|----------|---|-----------|
| 7 | Appendix | 50 |
| 7.1 | Safety checks | 50 |
| 7.2 | Tests for utilisation in hygienically sensitive areas | 50 |
| 7.3 | Working to GMP (Good Manufacturing Practice) | 51 |
| 7.4 | Tables of geo values | 51 |
| 7.5 | FCC | 54 |
| 8 | Index | 55 |

1 Introduction

1.1 Safety instructions for the explosion protected weighing terminal IND429xx



The device fulfills Device category 3 and is approved for operation in Zone 2 (gases) and Zone 22 (dusts) hazardous areas.

There is an increased risk of injury and damage when used in hazardous areas.

Special care must be taken when working in such hazardous areas. The code of practice is oriented to the "Safe Distribution" concept drawn up by METTLER TOLEDO.

Competence

- ▲ The device, accompanying weighing platforms and accessories may only be installed, maintained and repaired by authorized METTLER TOLEDO service personnel.
- ▲ The mains connection may only be connected or disconnected by the owner's electrician.

Ex approval

- ▲ For the exact specification please refer to the statement of conformity.
- ▲ No modifications may be made to the terminal and no repair work may be performed on the modules. Any weighing platform or system modules that are used must comply with the specifications contained in the installation instructions. Non-compliant equipment jeopardizes the safety of the system, cancels the Ex approval and renders any warranty or product liability claims null and void.
- ▲ The cable glands must be tightened so that a strain relief of ≥ 20 N per mm cable diameter is ensured.
- ▲ When connecting external devices, always observe the maximum permissible connected loads, refer to the installation instructions. It must be ensured that no voltages are fed into the device than it itself provides. The interface parameters have to fulfil the standard.
- ▲ Peripheral devices without an Ex approval may only be operating in non-hazardous areas. It must be ensured that no voltages are fed into the device than it itself provides. In addition the maximum permissible connected loads have to be observed, refer to the installation instructions. The interface parameters have to fulfil the standard.
- ▲ The safety of the weighing system is only guaranteed when the weighing system is operated, installed and maintained in accordance with the respective instructions.

- Ex approval**
- ▲ Also comply with the following:
 - the instructions for the system modules,
 - the regulations and standards in the respective country,
 - the statutory requirement for electrical equipment installed in hazardous areas in the respective country,
 - all instructions related to safety issued by the owner.
 - ▲ Before initial start-up and following service work, check the explosion protected weighing system for the proper condition of all safety-related parts.
- Operation**
- ▲ Prevent the build-up of static electricity. Therefore:
 - always wear suitable working clothes when operating or performing service work on the system,
 - do not rub or wipe off the keyboard surface with a dry cloth or glove.
 - ▲ Do not use protective hoods.
 - ▲ Prevent damage to the weighing terminal. Hairline cracks in the keyboard membrane are also considered damage.
 - ▲ If the weighing terminal, accompanying weighing platforms or accessories are damaged:
 - Switch off weighing terminal.
 - Separate the weighing terminal from the mains in accordance with the applicable regulations.
 - Secure the weighing terminal against accidental start-up.
 - ▲ Always charge the storage batteries in a safe zone.
 - ▲ Ensure that the supply voltage at the installation site amounts to 230 V.

1.2 Safety instructions for non-explosion-protected devices



- ▲ Do not use the device in an hazardous environment!
Special devices are available in our range of products for hazardous environments.
- ▲ Ensure that the power socket outlet for the device is earthed and easily accessible, so that it can be de-energized rapidly in emergencies.
- ▲ Ensure that the supply voltage at the installation site lies within in the range of 100 V to 240 V.
- ▲ The safety of the device cannot be ensured if it is not operated in accordance with these operating instructions.
- ▲ Only authorized personnel may open the device.
- ▲ Check the power cable regularly for damage. If it is damaged, disconnect the device immediately from the power supply.
- ▲ Ensure that there is a space of at least 3 cm at the rear in order to prevent the power cable from being bent too strongly.

1.3 Disposal

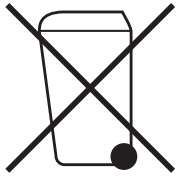

In conformance with the European Directive 2002/96 EC on Waste Electrical and Electronic Equipment (WEEE) this device may not be disposed of with domestic waste. This also applies to countries outside the EU, per their specific requirements.

→ Please dispose of this product in accordance with local regulations at the collecting point specified for electrical and electronic equipment.

If you have any questions, please contact the responsible authority or the distributor from which you purchased this device.

Should this device be passed on to other parties (for private or professional use), the content of this regulation must also be related.

Thank you for your contribution to environmental protection.

If the device is equipped with a storage battery:

The nickel metal hydride (NiMH) storage battery does not contain any heavy metals. However, it may not be disposed of with the normal refuse.

→ Observe the local regulations on the disposal of materials that are hazardous to the environment.

1.4 Use in hygienically sensitive areas

The device is suitable for use in hygienically sensitive areas. It fulfils the following requirements on areas coming into contact with the product (keyboard) and areas not coming into contact with the product (housing, stand):

- Suitability of the materials for contact with foodstuffs
- Continuous bonding joints that do not act on the material
- Smooth, non-porous and flat surfaces that are easy to clean
- Continuous welding seams
- No sharp corners

For further information please refer to Sections 7.2 and 7.3.

1.5 Description

1.5.1 Weighing terminals IND429 and IND429xx

METTLER TOLEDO weighing platforms can be connected without problems to the weighing terminals.

The weighing terminals are available in two different basic versions: for connecting analog scales or for digital scales with IDNet interface.

Both basic versions are supplied by default with in-built power supply unit and an RS232 interface.

IND429xx is approved for use in hazardous areas of the Category 3.

1.5.2 Compact scale BBA429

The compact scale BBA429 consists of a terminal-stand combination that is connected to an analog weighing platform of the PBA430 series.

The compact scale is supplied by default with an in-built power supply unit and an RS232 interface.

1.5.3 Additional equipment

The following alternatives are also possible:

- Power supply via in-built storage battery
- Version for external power supply 12 – 24 V DC
- Power supply via an external storage battery (not for IND429xx)
- Additional second communication interface

One of the following options is available as the second communication interface:

- RS232
- RS485/RS422
- Ethernet interface
- USB interface
- Digital I/O
- WLAN

1.5.4 Overview

- 1** Keys
- 2** Display
- 3** Measuring data sign

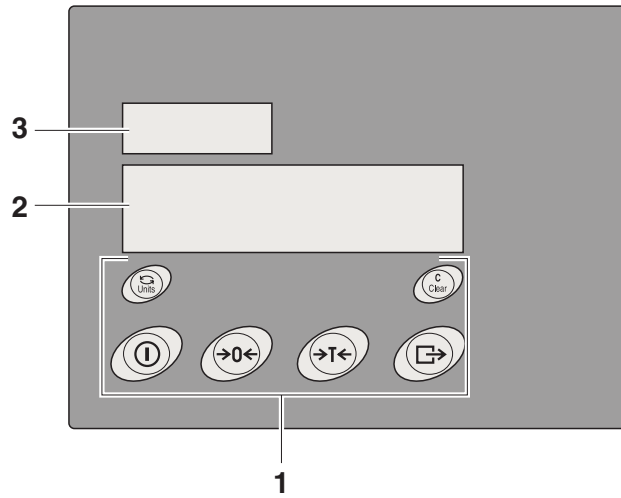

Weighing terminal connections

- 1** Power supply connection
- 2** Pressure compensation
- 3** Equipotential bonding terminal, only for IND429xx
- 4** COM1 interface
- 5** COM2 interface (optional)
- 6** Antenna for optional WLAN interface
- 7** not assigned
- 8** Scale connection
- 9** Securing plate for the interface connections, only for IND429xx

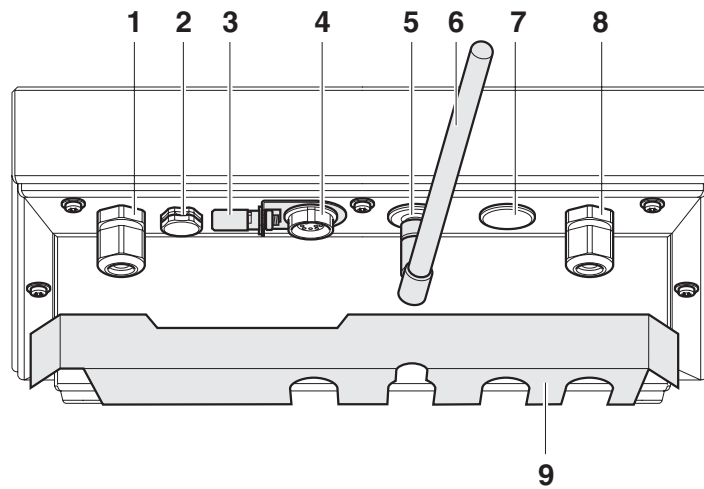

Compact scale connections



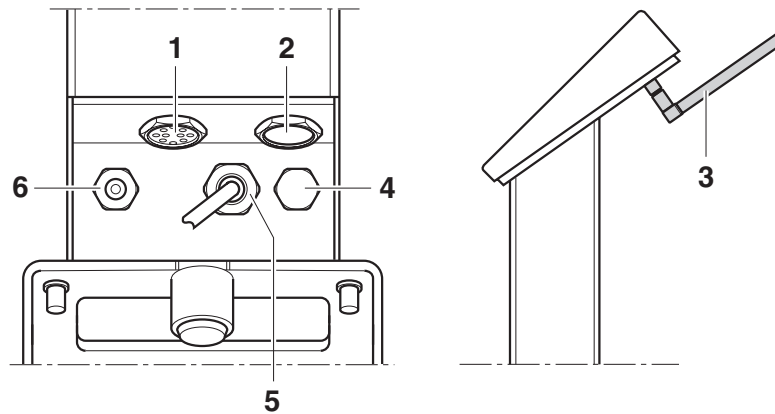
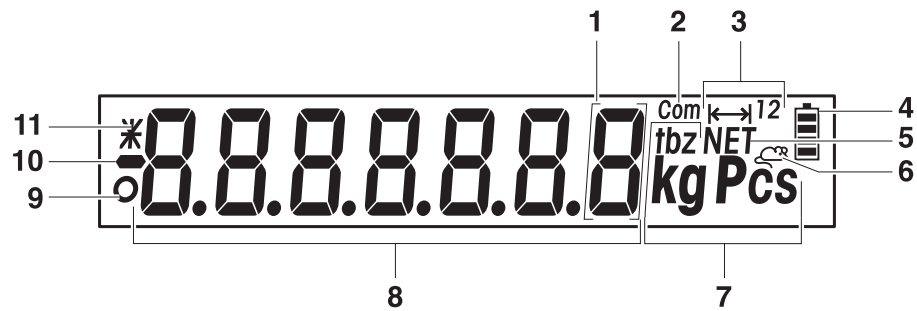

- 1** COM1 interface
- 2** COM2 interface (optional)
- 3** Antenna for optional WLAN interface
- 4** Pressure compensation
- 5** Power supply connection
- 6** Scale connection

**1.5.5 Display**



- 1** Notation for weight values with $e = 10 d$
- 2** Active interface
- 3** Weighing range display
- 4** Charge state of the storage battery, only for devices with storage battery
- 5** Symbol for displaying net values
- 6** Symbol for dynamic weighing
- 7** Weight units
- 8** 7-segment display, 7 digits, with decimal point
- 9** Standstill check (goes out when a stable weight value has been reached)
- 10** Sign
- 11** Notation for modified or calculated weight values, e.g. higher resolution, weight below minimum value

1.5.6 Keyboard

Main functions

| Key | Function in the operating mode | Function in the menu |
|---|--|---|
|  | Switch the terminal on/off; cancel | To the last menu item –End– |
|  | Set scale to zero, delete tare Long keypress at scales with IDNet interface: Display of the ID code and checking of the calibration | Page backwards |
|  | Tare scale, delete tare | Page forwards |
|  | Transfer key Long keypress: Call up menu | Activate menu item Accept selected setting |

Additional functions

| Key | Function |
|---|-------------------------|
|  | Switch over weight unit |
|  | Delete key |

1.6 Commissioning

The weighing platform connection to the weighing terminals IND429 / IND429xx as well as the commissioning of the interfaces are described in the "IND4x9 / BBA4x9" installation instructions.

→ Call the METTLER TOLEDO service or carry out commissioning in accordance with the installation instructions.

1.6.1 Limited mobility at explosion protected weighing terminal IND429xx



CAUTION!

The device may only be operated in Zone 2 and 22 hazardous areas.

- ▲ Protect data and signal cable extensions against inadvertent disconnection.
- ▲ Secure the interface connections on the rear using the interface plate.

1.6.2 Labelling for operation in hazardous area

The following signs must be mounted on the device, accompanying weighing platforms and accessories so that they are clearly visible:

- Model plate and the device's model data, manufacturer and serial number
- Safety instructions
- Explosion protection identification
- If appropriate, temperature range

1.6.3 Establishing a mains connection at an explosion protected weighing terminal IND429xx



CAUTION!

The mains connection may only be connected by the owner's electrician.



CAUTION!

The device only operates correctly at a supply voltage of 230 V.

- ▲ Do not under any circumstances connect the device if the voltage value on the rating plate deviates from the local system voltage.
- ▲ Only connect the device to an earthed mains connection.
- ▲ Ensure that equipotential bonding has been implemented.

1.6.4 Establishing a mains connection at non-explosion-protected devices



CAUTION!

Before connecting the power supply check whether the voltage value printed on the rating plate agrees with the local system voltage.

▲ Do not under any circumstances connect the device if the voltage value on the rating plate deviates from the local system voltage.

→ Plug the power plug into the power socket.

After it has been connected, the device carries out a self-testing routine. The device is ready to operate when the zero display appears.

1.6.5 Devices with built-in or external storage battery

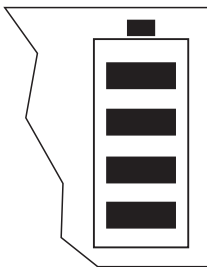

The operating life depends on the intensity of use, the configuration and the connected scale. For details see Section 6.1.2.

The battery symbol shows the current charge state of the storage battery. 1 segment corresponds to approx. 25% capacity. If the symbol flashes, the storage battery has to be charged. If work is continued during the charging process, the charging time is extended. The storage battery is protected against overcharging.

The charging time of the storage battery amounts to approx. 6 hours. If the device continues to be operated during the charging process, the charging time is extended. The storage battery has a service life of approx. 1,000 charging/discharging cycles.



CAUTION!

Explosion hazard!

▲ In the case of explosion protected devices the storage battery may only be charged in a safe area.



CAUTION!

Danger of soiling! The charger for the storage battery is not protected to IP69K.

▲ Do not charge the device in humid or dusty rooms.

▲ After the internal storage battery has been charged, close the cover cap of the charging socket at the device.

▲ Close the cover cap of the charging socket again at an external storage battery.

▲ In order to maintain degree of protection IP69K, make sure at devices with an external storage battery that the external storage battery is connected firmly to the device. Ensure that the plug connector of the external storage battery is inserted into the socket outlet of the device until it will go no further.

Note The storage battery is also suitable for permanent mains operation.

→ In order to obtain the full nominal capacity we recommend that you discharge the storage battery at regular intervals (approx. every 4 weeks) through normal operation.

1.6.6 Devices with external power supply 12 – 24 V DC

Explosion protected weighing terminals IND429xx

The device is supplied with a fixed-mounted 2.5 m long connecting cable with open ends.

Connection values: 12 – 24 V DC, max. 800 mA.

Non-explosion-protected devices

The device is equipped with a socket for connecting the power supply.

Connection values: 12 – 24 V DC, max. 800 mA.

A connecting cable with open ends is included with the device.



CAUTION!

Danger of soiling!

- ▲ In order to maintain degree of protection IP69K, make sure at devices with an external power supply that the connecting cable is connected firmly to the device. Ensure that the plug connector of the connecting cable is inserted into the socket outlet of the device until it will go no further.

1.6.7 Verification at partially verified scales

Partially verified scales (scales with first-stage verification) and scales with IDNet interface have to be verified by an authorized office or the METTLER TOLEDO Service.

→ Call the METTLER TOLEDO Service.

Note Adjust non-verified analog scales for the maximum precision, refer to Section 3.3.1.

2 Operation

2.1 Switching on and off

Switching on → Press .

The scale conducts a display test. Afterwards the software version identifier is displayed. When the weight display appears, the scale is ready to weigh.

Note

If  is pressed for a long time while switching on, the serial number of the device is also displayed after the software version identifier.

Switching off → Press .

Before the display goes out, **-OFF-** appears briefly.

2.2 Zeroing / Zero point correction

Zeroing corrects the influence of slight changes on the load plate or minor deviations from the zero point.

Manual 1. Unload scale.

2. Press .

The zero display appears.

Automatic In the case of scales that cannot be certified, the automatic zero point correction can be deactivated in the menu or the amount can be changed. Verified scales are set fixed to 0.5 d.

As standard, the zero point of the scale is automatically corrected when the scale is unloaded.

2.3 Simple weighing

1. Place weighing sample on scale.

2. Wait until the stability monitor  goes out.

3. Read weighing result.

2.4 Weighing with tare

2.4.1 Taring

→ Place the empty container on the scale and press .

The zero display and the symbol **NET** appear.

The tare weight remains saved until it is cleared.

2.4.2 Clearing the tare

→ Unload scale and press .

The symbol **NET** goes out, the zero display appears.

or

→ Press .

The symbol **NET** goes out, the gross weight appears in the display.

If `A.CL-tr` is activated in the menu under `SCALE` → `tArE`, the tare weight is automatically cleared as soon as the scale is unloaded.

2.4.3 Automatic taring

Prerequisite

`A-tArE` is activated in the menu under `SCALE` → `tArE`, the symbol **T** flashes in the display.

The packaging material must be heavier than 9 display steps of the scale.

→ Place the container or packaging material on the scale.

The packaging weight is automatically saved as the tare weight, the zero display and the symbol **NET** appear.

2.4.4 Chain tare

Prerequisite

The tare function `CHAIIn.tr` is activated in the menu under `SCALE -> tArE`.

With this function it is possible to tare several times if, for example, cardboard is placed between individual layers in a container.

1. Place the first container or packaging material on the scale and press .

The packaging weight is automatically saved as the tare weight, the zero display and the symbol **NET** appear.

2. Weigh the weighing sample and read/print out the result.

3. Place the second container or packaging material on the scale and press  again.

The total weight on the scale is saved as the new tare weight. The zero display appears.

4. Weigh the weighing sample in the second container and read/print the result.
5. Repeat the last two steps for other containers.

2.5 Dynamic weighing

With the dynamic weighing function, it is possible to weigh restless weighing samples such as live animals. If this function is activated, the symbol  appears in the display.

With dynamic weighing, the scale calculates the mean value from 56 weighing operations within 4 seconds.

With manual start Prerequisite

`AVERAGE -> MAnuAL` is selected in the menu.

The weighing sample must be heavier than 5 scale divisions.

1. Place the weighing sample on the scale and wait until it has stabilized.
2. Press  to start dynamic weighing.

During dynamic weighing, horizontal segments appear in the display, and the dynamic result is then displayed with the symbol *****.

3. Unload the scale to be able to start a new dynamic weighing operation.

With automatic start Prerequisite

AVERAGE → AUTO is selected in the menu.

The weighing sample must be heavier than 5 scale divisions.

1. Place the weighing sample on the scale.

The scale starts the dynamic weighing automatically.

During dynamic weighing, horizontal segments appear in the display, and the dynamic result is then displayed with the symbol *.

2. Unload the scale to be able to perform a new dynamic weighing operation.

2.6 Printing results

If a printer or computer is connected to the scale, the weighing results can be printed out or sent to a computer.

→ Press .

The display contents are printed out or transferred to the computer.

2.7 Cleaning

The device conforms to degree of protection IP69K to DIN 40050.

It is suitable for hygienically sensitive areas - see the proofs in Section 7.2.

The device is designed so that it can be cleaned easily. The housing is made of stainless steel 1.4301 (AISI 304), the keyboard of resistant polyester (PE). If required, high-pressure equipment can be used for cleaning.

Cleaning

- Close open connectors with cap plugs.
- Clean the protective hood of the non-explosion-protected devices separately. The protective hood is dishwasher-proof.
- Replace protective hoods regularly.
- Use a moist cloth for minor soiling.
- Do not use acids, alkaline solutions or strong solvents.
- Observe the following limits when using high-pressure equipment:
 - Max. water temperature 80 °C / 176 °F
 - Max. water pressure 8,000 kPa (80 bars)
 - Min. distance jet nozzle to terminal 50 cm
 - Do not point the jet at one point for longer than 10 seconds
 - Water flow rate not greater than 10 l/min
- Observe all the existing regulations on cleaning intervals and permissible cleaning agents.

Information on cleaning the weighing platform connected to the weighing terminal

- Be sure to observe the cleaning instructions for the connected weighing platform. The weighing platform may not be designed for cleaning with high-pressure equipment.

2.8 Testing of weighing terminal and scale/display of the ID code (only for weighing terminals with IDNet interface)

The ID code is increased by 1 at every calibration in case of IDNet scales. For verified scales, the ID code displayed by the weighing terminal must match the ID code on the ID cards. Otherwise, the verification is no longer valid.

2.8.1 Displaying the ID code

1. Unload weighing platform.
2. Press the  key and keep it pressed until the display changes to -----.
The ID code is then displayed: CODE= . . .

2.8.2 Testing the weighing platform and terminal

- After the ID code is displayed, press the  key again.
CHE CAL is displayed. The weighing platform is tested.
After a successful test CAL ok is displayed briefly.
The terminal then changes to normal operation.

Note If a calibration error CAL Err is displayed during testing, repeat the test. If the error is displayed again, inform the METTLER TOLEDO Service.

3 Settings in the menu

Settings can be changed and functions can be activated in the menu. This enables adaptation to individual weighing requirements.



The menu consists of 6 main blocks containing various submenus on several levels.

3.1 Operating the menu

3.1.1 Calling up the menu and entering the password



The menu differentiates between 2 operating levels: Operator and Supervisor. The Supervisor level can be protected by a password. When the device is delivered, both levels are accessible without a password.

Operator menu

1. Press  and keep it pressed until CODE appears.
2. Press  again.

The menu item tErMINL appears. Only the submenu dEVICE is accessible.

Supervisor menu

1. Press  and keep it pressed until CODE appears.
2. Enter the password and confirm with .



The first menu item SCALE appears.

Note

No supervisor password has been defined when the device is first delivered. Therefore, respond to the password inquiry with  when you call up the menu for the first time. If a password has still not been entered after a few seconds, the scale returns to weighing mode.

Emergency password for Supervisor access to the menu

If a password has been issued for Supervisor access to the menu and you have forgotten it, you can still enter the menu:

- Press  3 times and confirm with .

3.1.2 Selecting and setting parameters

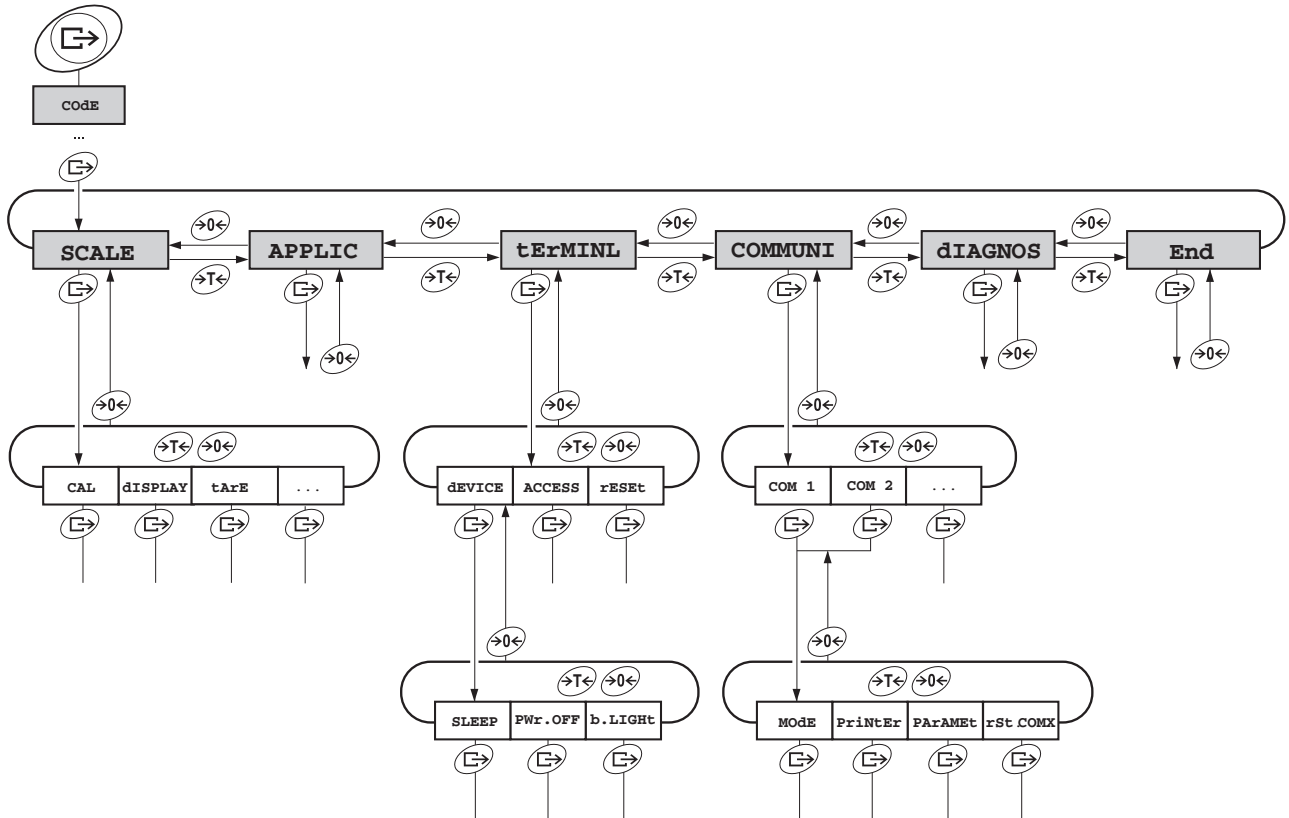

- Scrolling on one level**
- Scroll forward: Press →T←.
 - Scroll back: Press →0←.

- Activating menu items/ accepting selection**
- Press →.

- Exiting menu**
1. Press ○.
 - The last menu item End appears.
 2. Press →.
 - The inquiry SAVE appears.
 3. Confirm inquiry with → to save the settings and return to weighing mode.
 - or-
 - Press →T← to discard changes and return to weighing mode.

Note The SCALE menu block depends on the built-in scale interface.

3.2 Overview

Factory settings are printed **bold** in the following overview.

| Level 1 | Level 2 | Level 3 | Level 4 | Level 5 | Level 6 | Page | | |
|--------------------------|----------|---|---|---------|---------|------|----|--|
| SCALE (analog) | CAL | | | | | 25 | | |
| | dISPLAY | UNIt1 | g, kg , oz, lb, t | | | | 25 | |
| | | UNIt2 | g , kg, oz, lb, t | | | | | |
| | | rESOLU | | | | | | |
| | | UNt.rOLL | ON, OFF | | | | | |
| | tArE | A-tArE | ON, OFF | | | | 25 | |
| | | ChAIn.tr | ON , OFF | | | | | |
| | | A.CL-tr | ON, OFF , 9 d | | | | | |
| | ZErO | AZM | OFF; 0.5 d ; 1 d; 2 d; 5 d; 10 d | | | | 25 | |
| | rEStArt | ON, OFF | | | | | 26 | |
| | FILtEr | VibrAt | LOW, Med , HIGH, | | | | 26 | |
| | | PrOCeSS | UNIVER , dOSING | | | | | |
| | | StAbILI | FASt, StAndrd , PrECISE | | | | | |
| | Min.WEiG | ON/OFF | ON, OFF | | | | 26 | |
| rESEt | SUrE? | | | | | 26 | | |
| SCALE (IDNet) | dISPLAY | UNIt2 | g , kg, oz, lb, t | | | | 27 | |
| | | UNt.rOLL | ON, OFF | | | | | |
| | tArE | A-tArE | ON, OFF | | | | 27 | |
| | | ChAIn.tr | ON , OFF | | | | | |
| | | A.CL-tr | ON, OFF , 9 d | | | | | |
| | ZErO | AZM | ON , OFF | | | | 27 | |
| | rEStArt | ON, OFF | | | | | 27 | |
| | FILtEr | VibrAt | StAbLE, nOrMAL , UnStAbL, | | | | 28 | |
| | | PrOCeSS | FinEFiL, UNIVERs , AbSOLUt | | | | | |
| | | StAbILI | ASd=0, ASd=1, ASd=2 , ASd=3, ASd=4 | | | | | |
| | UPdAtE | Setting possibilities depend on the connected scale | | | | | 28 | |
| Min.WEiG | ON/OFF | ON, OFF | | | | 28 | | |
| rESEt | SUrE? | | | | | 28 | | |
| APPLIC | AVErAGE | OFF , AUtO, MAnuAL | | | | 29 | | |
| | rESEt | SUrE? | | | | 29 | | |



| Level 1 | Level 2 | Level 3 | Level 4 | Level 5 | Level 6 | Page | |
|----------------|-------------------------|----------|---|----------------------------------|---------------------------------|------|----|
| tERMINL | dEVICE | SLEEP | OFF , 1 min, 3 min, 5 min, 15 min, 30 min | | | 29 | |
| | | PWr OFF | OFF , 1 min, 3 min, 5 min, 15 min, 30 min | | | | |
| | | b.LIGHT | ON , OFF , 5 sec, 10 sec, 30 sec, 1 min | | | | |
| | ACCESS | SUPeRVI | | | | 30 | |
| | rESEt | SUrE? | | | | 30 | |
| COMMUNI | COM 1/COM 2 | MOdE | Print | | | 30 | |
| | | | A.Print | | | | |
| | | | CONTINU | | | | |
| | | | dIALOG | | | | |
| | | | MMr | | | | |
| | | | MMr.A.SIr | | | | |
| | | | CONT.OLd | | | | |
| | | | dIAL.OLd | | | | |
| | | | dt-b | GrOSS | ON, OFF | | |
| | | | | tArE | ON, OFF | | |
| | | | | nEt | ON, OFF | | |
| | | | dt-G | GrOSS | ON, OFF | | |
| | | | | tArE | ON, OFF | | |
| | | nEt | | ON, OFF | | | |
| | | COnt-Wt | | | | | |
| | | 2nd.dISP | | | | | |
| | | InSt.Prn | | | | | |
| | | PriNtEr | tYPE | ASCII , GA46 | | | 31 |
| | | | tEMPLat | stdArd , tEMPLt1, tEMPLt2 | | | |
| | | | ASci.Fmt | LINE.FMt | MULtI SINGLE FIXEd | | |
| LENGtH | 1 ... 24 ... 100 | | | | | | |
| SEPArAt | , ; ... | | | | | | |
| Add LF | 0 ... 9 | | | | | | |

| Level 1 | Level 2 | Level 3 | Level 4 | Level 5 | Level 6 | Page |
|----------------|---------|---------------------|-----------------------------------|---|---------|------|
| | | PARAMeT | bAUd | 300 ... 2400 ... 38400 | | 31 |
| | | | PARity | 7 nonE, 8 nonE, 7 odd, 8 odd, 7 EVEN , 8 EVEN | | |
| | | | H.SHAKE | NO, XONXOFF , nEt 422, nEt 485 | | |
| | | | NEt.Addr | 0 ... 31 | | |
| | | | ChECSuM | ON, OFF | | |
| | | | Vcc | ON, OFF | | |
| | | rSt.COMx | SUrE? | | 32 | |
| COMMUNI | OPTION | EtH.NEt | IP.AddrS, SUBnEt, GAtEWAY | | 32 | |
| | | WLAn | IP.AddrS, SUBnEt, GAtEWAY, SIGNAL | | | |
| | | USb | USb tEST | | | |
| | | diGitAL | IN 0 ... 3 | OFF , ZErO, tArE, Print, CLEar, UNIt | | |
| | | | OUt 0 ... 3 | OFF , StAbLE, bEL.Min, AbV.Min, UndErLd, OVErLd, StAr, ... | | |
| | | | | SEt.Pt 1 | | |
| | | | SEt.Pt 2 | | | |
| | dEF.PrN | tEMPLt1/ tEMPLt2 | LINE 1 ... LINE 8 | Not .USED , HEAdEr, GrOSS, tArE, nEt, StArLN, CrLF, F.FEEd | 33 | |
| dIAGNOS | tEST SC | | | | | 34 |
| | KboArd | | | | | |
| | dISPLAY | | | | | |
| | SNr | | | | | |
| | LiSt | | | | | |
| | | rESEt.AL | SUrE? | | | |

3.3 Scale settings (SCALE) – analog

3.3.1 CAL – calibration (adjustment)

This menu item is not available for certified scales.

| | |
|-----|--|
| CAL | <ol style="list-style-type: none"> 1. Unload scale. 2. Activate menu item CAL with . The scale determines the zero point. -0- appears in the display. The calibration weight to be placed on the scale then flashes in the display. 3. If necessary, change the weight value displayed with . 4. Place the calibration weight on the scale and confirm with . <p>The scale calibrates with the calibration weight loaded. After calibration is completed, -donE- appears briefly in the display, and the scale automatically returns to weighing mode.</p> <p>In order to achieve particularly high precision, calibrate under full load.</p> |
|-----|--|

3.3.2 DISPLAY – weighing unit and display accuracy

| | |
|------------|--|
| UNIt1 | Select weighing unit 1: g, kg, oz, lb, t |
| UNIt2 | Select weighing unit 2: g, kg, oz, lb, t |
| rESOLU | Select readability (resolution), model-dependent |
| UNt . rOLL | When UNt . rOLL is switched on, the weight value can be displayed in all available units with  . |
| Notes | <ul style="list-style-type: none"> • In the case of certified scales individual sub-items of the dISPLAY menu item may not be available or only to a limited extent, depending on the respective country. • On dual-range/dual interval scales, resolutions marked with <-> 1/2 are divided up into 2 weighing ranges / intervals, e.g. 2 x 3000 d. |

3.3.3 TARE – tare function

| | |
|-----------|---|
| A-tArE | Switching on/off automatic taring |
| CHAIIn.tr | Switching on/off chain tare |
| A.CL-tr | Switching on/off automatic clearing of the tare weight when the load is removed from scale Possible settings: OFF, ON, 9 d |

3.3.4 ZERO – automatic zero update

| | |
|-----|---|
| AZM | On certified scales, this menu item does not appear. Switching on/off automatic zero update and selecting zeroing range. Possible settings: OFF; 0.5 d; 1 d; 2 d; 5 d; 10 d |
|-----|---|

3.3.5 RESTART – automatic saving of zero point and tare value

| | |
|---------------|--|
| ON/OFF | When the Restart function is activated, the last zero point and tare value are saved. After switching off / on or after a power interruption, the device continues to work with the saved zero point and tare value. |
|---------------|--|

3.3.6 FILTER – adaptation to the ambient conditions and the weighing type



| | |
|--|--|
| VibrAt LOW MED HIGH | Adaptation to the ambient conditions <ul style="list-style-type: none"> • Very steady and stable environment. The scale works very rapidly, but is very sensitive to external influences. • Normal environment. The scale operates at medium speed. • Restless environment. The scale works more slowly, but is insensitive to external influences. |
| PrOCeSS UNIVER dOSING | Adaptation to the weighing process <ul style="list-style-type: none"> • Universal setting for all weighing samples and normal weighing goods • Dispensing liquid or powdery weighing samples |
| StAbILI FASt StAndrd PrECISE | Adjusting the stability detector <ul style="list-style-type: none"> • The scale operates very fast. • The scale operates at medium speed. • The scale operates with the greatest possible reproducibility. <p>The slower the scale works, the greater the reproducibility of the weighing results.</p> |

3.3.7 MIN.WEIG – minimum weight

This menu item appears only if the service technician has saved a minimum weight.

| | |
|---------------|---|
| ON/OFF | Switching minimum weight function on/off If the weight on the scale falls below the stored minimum weight, an * appears on the display in front of the weight indicator. |
|---------------|---|

3.3.8 RESET – resetting scale settings to factory settings

| | |
|--------------|--|
| SUrE? | Confirmation inquiry <ul style="list-style-type: none"> • Reset the scale settings to factory settings with  • Do not reset scale settings with  |
|--------------|--|

3.4 Scale settings (SCALE) – IDNet

3.4.1 DISPLAY – weighing unit

| | |
|-----------------|---|
| UNIt2 | Select weighing unit 2: g, kg, oz, lb, t |
| UNT.rOLL | When UNT.rOLL is switched on, the weight value can be displayed in all available units with  . |
| Notes | <ul style="list-style-type: none"> In the case of certified scales individual sub-items of the dISPLAY menu item may not be available or only to a limited extent, depending on the respective country. For two-range/two-interval scales, resolutions identified with <-> 1/2 are divided into the 2 weighing ranges/intervals, for example 2 x 3000 d. |

3.4.2 TARE – tare function

| | |
|------------------|---|
| A-tArE | Switching on/off automatic taring |
| CHAIIn.tr | Switching on/off chain tare |
| A.CL-tr | Switching on/off automatic clearing of the tare weight when the load is removed from scale Possible settings: OFF, ON, 9 d |

3.4.3 ZERO – automatic zero update

| | |
|------------|---|
| AZM | <p>On certified scales, this menu item does not appear.</p> <p>Switching on/off automatic zero update.</p> <p>The effective range of the zero update mode (0.5 d, 1.0 d, 3.0 d) can only be set by service technicians in case of IDNet scales.</p> <p>Factory setting: 0.5 d</p> |
|------------|---|

3.4.4 RESTART – automatic saving of zero point and tare value

| | |
|---------------|---|
| ON/OFF | When the Restart function is activated, the last zero point and tare value are saved. After switching off /on or after a power interruption, the device continues to work with the saved zero point and tare value. |
|---------------|---|

3.4.5 FILTER – adaptation to the ambient conditions and the weighing type

| | | | | | | | | | | | | | | | | | | | |
|---|--|---------------------------|-----------------------------------|--|--|---|--|---------|---------------|----------------------|---------|---|---|---------|---|---|---------|--------------|---------------------------|
| VIbrAt StAbLE nOrMAL UnStAbL | Adaptation to the ambient conditions <ul style="list-style-type: none"> • Very steady and stable environment. The scale works very rapidly, but is very sensitive to external influences. • Normal environment. The scale operates at medium speed. • Restless environment. The scale operates more slowly, but is insensitive to external influences. | | | | | | | | | | | | | | | | | | |
| PrOCeSS FinEFiL UniVERs AbSOLUt | Adaptation to the weighing process <ul style="list-style-type: none"> • Dispensing of liquid or powdered weighing samples • Universal setting for all weighing modes and normal weighing samples • For solid bodies under extreme conditions, e.g. strong vibrations | | | | | | | | | | | | | | | | | | |
| StAbILI ASd=0 ... ASd=4 | <table border="0"> <tr> <td>ASD = 0</td> <td>Stability monitoring switched off</td> <td></td> </tr> <tr> <td></td> <td>Only possible for non-verifiable weighing platforms</td> <td></td> </tr> <tr> <td>ASD = 1</td> <td>Rapid display</td> <td>Good reproducibility</td> </tr> <tr> <td>ASD = 2</td> <td>↑</td> <td>↓</td> </tr> <tr> <td>ASD = 3</td> <td>↑</td> <td>↓</td> </tr> <tr> <td>ASD = 4</td> <td>Slow display</td> <td>Excellent reproducibility</td> </tr> </table> | ASD = 0 | Stability monitoring switched off | | | Only possible for non-verifiable weighing platforms | | ASD = 1 | Rapid display | Good reproducibility | ASD = 2 | ↑ | ↓ | ASD = 3 | ↑ | ↓ | ASD = 4 | Slow display | Excellent reproducibility |
| ASD = 0 | Stability monitoring switched off | | | | | | | | | | | | | | | | | | |
| | Only possible for non-verifiable weighing platforms | | | | | | | | | | | | | | | | | | |
| ASD = 1 | Rapid display | Good reproducibility | | | | | | | | | | | | | | | | | |
| ASD = 2 | ↑ | ↓ | | | | | | | | | | | | | | | | | |
| ASD = 3 | ↑ | ↓ | | | | | | | | | | | | | | | | | |
| ASD = 4 | Slow display | Excellent reproducibility | | | | | | | | | | | | | | | | | |

3.4.6 UPDATE – setting the display speed of the weight display

This menu item is only displayed if the UPDATE function is supported by the connected weighing platform.



| | |
|---------------|--|
| xx UPS | Selecting the number of updates per second (UPS) |
| Note | The possible settings depend on the connected weighing platform. |

3.4.7 MIN.WEIG – minimum weighing-in quantity

This menu item appears only if the service technician has saved a minimum weight.

| | |
|---------------|---|
| ON/OFF | Switching minimum weight function on/off If the weight on the scale falls below the stored minimum weight, an * appears on the display in front of the weight indicator. |
|---------------|---|

3.4.8 RESET – resetting scale settings to factory settings



| | |
|-------------|--|
| SUR? | Confirmation inquiry <ul style="list-style-type: none"> • Reset the scale settings to factory settings with  • Do not reset scale settings with  |
|-------------|--|

3.5 Application settings (APPLICATION)

3.5.1 AVERAGE – determining the average weight for an unstable load

| | |
|---------------|--|
| OFF | Calculating average weight switched off |
| AUTO | Calculating average weight with automatic start of the weighing cycle |
| MANUAL | Calculating average weight with manual start of the weighing cycle via  |

3.5.2 RESET – resetting application settings to factory settings





| | |
|--------------|--|
| SURE? | Confirmation inquiry <ul style="list-style-type: none"> Reset the application settings to factory settings with  Do not reset the application settings with  |
|--------------|--|

3.6 Terminal settings (TERMINAL)



3.6.1 DEVICE – sleep mode, energy-saving mode and display backlighting

| | |
|-------------------------------------|---|
| SLEEP | This menu item only appears on devices in mains operation. When SLEEP is activated, the scale switches off display and backlighting after the time period set when not in use. The display and backlighting are switched on again at the press of a key or if the weight changes. Possible settings: OFF, 1 min, 3 min, 5 min, 15 min, 30 min |
| PWR OFF | This menu item only appears on devices in battery operation. When PWR OFF is activated, the device switches itself off automatically after approx. 3 minutes when not in use. After this, it must be switched on again using  . Possible settings: OFF, 1 min, 3 min, 5 min, 15 min, 30 min |
| b.LIGHT OFF / 5 sec / ... | Set the background lighting of the display Setting whether and after which time the background lighting is to be switched off. Scales with a storage battery switch the background lighting off automatically by default when no action takes place at the scale for approx. 5 seconds. Possible settings: OFF (switched off), 5 sec, 10 sec, 30 sec, 1 min, ON (switched on) |
| Notes | <ul style="list-style-type: none"> This menu item is accessible without a Supervisor password. The time specifications are approximate values. |

3.6.2 ACCESS – password for Supervisor menu access

| | |
|---|---|
| SUPeRVI ENTEr.C rEtYPE.C | <p>Password entry for Supervisor menu access</p> <p>Request to enter password</p> <p>→ Enter the password and confirm with .</p> <p>Request to repeat the password entry</p> <p>→ Enter the password again and confirm with .</p> |
| Notes | <ul style="list-style-type: none"> The password can consist of up to 4 characters. The key  must not be part of the password. It is required for confirming the password. The key  may only be used in combination with another key. If you enter an impermissible code or make a typing error in the repetition, COdE.Err. appears in the display. |

3.6.3 RESET – resetting terminal settings to the factory settings

| | |
|--------------|---|
| SURe? | <p>Confirmation inquiry</p> <ul style="list-style-type: none"> Reset terminal settings to the factory settings with . Do not reset the terminal settings with . |
|--------------|---|

3.7 Configuring interfaces (COMMUNICATION)

3.7.1 COM1/COM2 -> MODE – operating mode of the serial interface

| | |
|-------------------------------------|--|
| Print | Manual data output to the printer with  |
| A.Print | Automatic output of stable results to the printer (e. g. for series weighing operations) |
| CONtINU | Ongoing output of all weight values via the interface |
| dIALOG | Bi-directional communication via MT-SICS commands, control of the scale via PC |
| MMr | Bidirectional communication via MMR commands, controlling of a scale via a PC, command set compatible to the weighing terminals ID1 and ID3. |
| MMr.A.SIr | Automatic continuous transmission: a stable or dynamic weight value is transmitted after every measuring cycle. |
| CONt.OLd | As per CONtINU, see above, but with 2 fixed blanks in front of the unit (compatible with Spider 1/2/3) |
| dIAL.OLd | As per dIALOG, see above, but with 2 fixed blanks in front of the unit (compatible with Spider 1/2/3) |
| dt-b GrOSS tArE nEt | <p>DigiTOL-compatible format.</p> <ul style="list-style-type: none"> Transfer of the gross weight, identified with "B" Transfer of the tare weight Transfer of the net weight |
| dt-G | As per dt-b, see above, gross weight identified with "G" |

| | |
|------------------|--|
| Cont -Wt | TOLEDO Continuous mode |
| 2nd.dISP | For connecting a second display (automatically activates the 5-V voltage supply at Pin 9) |
| InSt .Prn | Immediate manual data output to the printer with  (not certifiable) |

3.7.2 COM1/COM2 -> PRINTER – settings for protocol printout



This menu item only appears if the mode "Print" or "A.Print" is selected.

| | |
|------------------|---|
| tYPE | Select the printer type |
| ASCII | • ASCII printer |
| GA46 | • GA46 printer |
| tEmPLat | Selecting protocol printout |
| StdArd | • Standard printout |
| tEmPLt1 | • Printout in accordance with Template 1 |
| tEmPLt2 | • Printout in accordance with Template 2 |
| ASci .Fmt | Selecting formats for the protocol printout |
| LINE .Fmt | • Line format: MULTI (multiple lines), SINGLE (single lines) or FIXED (Records are output in single lines. Every record encompasses the number of character that was defined under LENGTH.) |
| LENGtH | • Line length: 0 to 100 characters, is only displayed at the line format MULTI and FIXED |
| SEPArAt | • Separator: , ; . / \ _ and space; appears only with line format SINGLE |
| Add LF | • Line feed: 0 ... 9 |

3.7.3 COM1/COM2 -> PARAMET – communication parameters





| | |
|------------------|---|
| baUD | Selecting baud rate: 300, 600, 1200, 2400, 4800, 9600, 19200, 38400 baud |
| PArity | Selecting parity: 7 none, 8 none, 7 odd, 8 odd, 7 even, 8 even |
| H .SHAKE | Select handshake: NO, XONXOFF, NET 422 (network operation via the optional RS422/RS485 interface via 4-wire bus, only for COM1), NET 485 (network operation via the optional RS422/RS485 interface via 2-wire bus, only for COM1) |
| NEt .Addr | Assigning network address: 0 ... 31, only for NET 485 |
| ChECSuM | Activating checksum byte (appears only in TOLEDO Continuous mode) |
| Vcc | Switching 5 V voltage, e.g. for a bar code reader or the optional interface RS485/422, on/off |

3.7.4 COM1/COM2 -> RESET COM1/RESET COM2 – resetting serial interface to factory settings

| | |
|--------------|--|
| SURe? | <p>Confirmation inquiry</p> <ul style="list-style-type: none"> • Reset interface settings to factory settings with  • Do not reset the interface settings with  |
|--------------|--|

3.7.5 OPTION – configuring options

If no option is installed or is not yet configured, N . A . appears in the display.











| | |
|--|--|
| <p>Eth.NET</p> <p>IP.AddrS</p> <p>SUBNET</p> <p>GATEWAY</p> | <p>Configuration of the Ethernet interface</p> <ul style="list-style-type: none"> • Enter IP address • Enter Subnet address • Enter Gateway address |
| <p>WLAN</p> <p>IP.AddrS</p> <p>SUBNET</p> <p>GATEWAY</p> <p>SIGNAL</p> | <p>Configuration of the WLAN interface</p> <ul style="list-style-type: none"> • Enter IP address • Enter subnet address • Enter gateway address • SIG ... shows the signal strength of the WLAN connection as a percentage value. 0 to 25 very weak 26 to 49 weak 50 to 74 good 75 to 100 excellent Reliable operation requires at least a good signal strength. |
| <p>USB</p> <p>USB tEST</p> | <p>Configuration of the USB interface</p> <ul style="list-style-type: none"> • Test of the USB interface. After the test has been passed, rEAdY appears in the display. |
| <p>digital</p> <p>IN 0 ... 3</p> <p>OFF</p> <p>ZErO</p> <p>tArE</p> <p>PrINt</p> <p>CLear</p> <p>UNIt</p> | <p>Configuration of the digital inputs/outputs</p> <p>Configuring inputs 0 ... 3</p> <ul style="list-style-type: none"> • Input not assigned • Key  • Key  • Key  • Key  • Key  |

| | |
|-------------|--------------------------------------|
| OUT 0 ... 3 | Configuring outputs 0 ... 3 |
| OFF | • Output not assigned |
| StAbLE | • Stable weight value |
| bEL.Min | • Minimum weight not reached |
| AbV.Min | • Minimum weight reached or exceeded |
| UNdErLd | • Insufficient load |
| OVERLd | • Overload |
| StAr | • Changed/calculated value |
| bEL.SP1 | • Setpoint 1 not reached |
| AbV.SP1 | • Setpoint 1 reached or exceeded |
| bEL.SP2 | • Setpoint 2 not reached |
| AbV.SP2 | • Setpoint 2 reached or exceeded |
| SEt.Pt1 | Enter value for setpoint 1 |
| SEt.Pt2 | Enter value for setpoint 2 |

3.7.6 DEF.PRN – configuring templates

| | |
|------------------------|---|
| tEMPLt1/tEMPLt2 | Selecting Template 1 or Template 2 |
| LINE 1 ... 8 | Selecting line |
| NOt.USEd | • Line not used |
| HEAdEr | • Line as header. The contents of the header must be defined via an interface command, see Section 4.1. |
| GrOSS | • Gross weight |
| tArE | • Tare weight |
| nEt | • Net weight |
| StArLN | • Line with *** |
| CrLF | • Line feed (blank line) |
| F.FEEd | • Page feed |

3.8 Diagnosis and printing out of the menu settings (DIAGNOS)

| | |
|--|---|
| <p>tEst SC</p> <p>External</p> | <p>Testing the scale</p> <p>This menu item is only displayed at scales with an analog scale interface.</p> <p>Testing scale with external calibration weight</p> <ol style="list-style-type: none"> 1. The scale checks the zero point. -0- appears in the display. The test weight flashes in the display. 2. If necessary, change the weight value displayed with . 3. Put the calibration weight on the scale and confirm with . 4. The scale checks the calibration weight put on them. 5. After the test is completed, the deviation from the last calibration briefly appears in the display, ideally *d=0.0g, after which the scale changes to the next menu item KboArđ. |
| <p>KboArđ</p> <p>PUSH 1 . . . 6</p> | <p>Keyboard test</p> <ul style="list-style-type: none"> • Press the keys       in order. If the key works, the scale changes to the next key. <p>Note</p> <p>You cannot abort the keyboard test!</p> <p>If you have selected the menu item KboArđ, you must press all keys.</p> |
| <p>dISPLAY</p> | <p>Display test: The scale displays all functioning segments</p> |
| <p>SNr</p> | <p>Display of the serial number</p> |
| <p>LiSt</p> | <p>Printout of a list of all menu settings</p> |
| <p>rESEt.AL</p> <p>SUrE?</p> | <p>Resetting all menu settings to the factory settings</p> <p>Confirmation inquiry</p> <ul style="list-style-type: none"> • Reset all menu settings to the factory settings with . • Do not reset the menu settings with . |

4 Interface description

4.1 SICS interface commands

The device supports the command set MT-SICS (METTLER TOLEDO **Standard Interface Command Set**). With SICS commands, it is possible to configure, query and operate the scales from a PC. SICS commands are divided up into various levels.

4.1.1 Available SICS commands

| | Command | Meaning |
|----------------|---------|---|
| LEVEL 0 | @ | Reset the scale |
| | I0 | Inquiry of all available SICS commands |
| | I1 | Inquiry of SICS level and SICS versions |
| | I2 | Inquiry of scale data |
| | I3 | Inquiry of scale software version |
| | I4 | Inquiry of serial number |
| | I6 | Inquiry of weighing parameters |
| | S | Send stable weight value |
| | SI | Send weight value immediately |
| | SIR | Send weight value repeatedly |
| | Z | Zero the scale |
| | ZI | Zero immediately |
| LEVEL 1 | D | Write text into display |
| | DW | Weight display |
| | K | Keyboard check |
| | SR | Send and repeat stable weight value |
| | T | Tare |
| | TA | Tare value |
| | TAC | Clear tare |
| | TI | Tare immediately |

In the case of Levels 0 and 1, these are commands which, if implemented, will function identically with all METTLER TOLEDO scales or weighing terminals.

In addition there are also further interface commands which apply either to the entire product series or to the particular application level. This and further information on the MT-SICS command set may be found in the MT-SICS Manual (Order Number 22 011 459 or at www.mt.com) or be obtained by request from your METTLER TOLEDO customer service representative.

4.1.2 Requirements for communication between scale and PC

- The scale must be connected to the RS232, RS485, USB or Ethernet interface of a PC with a suitable cable.
- The interface of the scale must be set to "Dialog" mode, see Section 4.6.1.
- A terminal program must be available on the PC, e.g. HyperTerminal.
- The communication parameters baud rate and parity must be set in the terminal program and on the scale to the same values, see Section 4.6.3.

4.1.3 Notes on network operation via the optional interface RS422/485

Up to 32 scales can be networked with the optional RS422/485 interface. In network operation, the scales must be addressed from the computer before commands can be sent and weighing results received.

| Address | Hex | ASCII |
|---------|------|-------|
| 0 | 0x30 | 0 |
| 1 | 0x31 | 1 |
| 2 | 0x32 | 2 |
| ... | ... | ... |
| 9 | 0x39 | 9 |
| 10 | 0x3A | : |
| 11 | 0x3B | ; |
| ... | ... | ... |
| 31 | 0x4F | 0 |

| Description of the steps | Host | Direction | Scale |
|---|-----------|-----------|--------------------------|
| 1. Host addresses the scale, e.g. with the address 3A hex. | <ESC> : | —> | |
| 2. Host sends a SICS command, e.g. SI | SI <CRLF> | —> | |
| 3. The scale confirms receipt of the command and sends the address back | | <— | <ESC>: |
| 4. The scale responds to the command and returns control of the bus to the host | | <— | S_S___45.02_kg <CRLF> |

4.2 TOLEDO Continuous mode

4.2.1 TOLEDO Continuous commands

In TOLEDO Continuous mode the scale supports the following input commands:

| Command | Meaning |
|----------|---------------------------------|
| P | Printing out the current result |
| T | Taring of the scale |
| Z | Zero setting of the display |
| C | Deleting of the current value |

4.2.2 Output format in TOLEDO Continuous mode

Weight values are always transferred in TOLEDO Continuous mode in the following format:

| 1 | Status | | | Field 1 | | | | | | Field 2 | | | | | | 17 | 18 |
|---------------|--------|--|-----|---------|---|---|---|---|-----|---------|----|----|----|----|-----|----|-----|
| | 2 | 3 | 4 | 5 | 6 | 7 | 8 | 9 | 10 | 11 | 12 | 13 | 14 | 15 | 16 | | |
| STX | SWA | SWB | SWC | MSD | - | - | - | - | LSD | MSD | - | - | - | - | LSD | CR | CHK |
| Field 1 | | Cont-Wt: 6 digits for the weight value that is transferred without comma and unit | | | | | | | | | | | | | | | |
| Field 2 | | Cont-Wt: 6 digits for the tare weight that is transferred without comma and unit | | | | | | | | | | | | | | | |
| STX | | ASCII character 02 hex, character for "start of text" | | | | | | | | | | | | | | | |
| SWA, SWB, SWC | | Status words A, B, C, see below | | | | | | | | | | | | | | | |
| MSD | | Most significant digit | | | | | | | | | | | | | | | |
| LSD | | Least significant digit | | | | | | | | | | | | | | | |
| CR | | Carriage Return, ASCII character 0D hex | | | | | | | | | | | | | | | |
| CHK | | Checksum (2-complement of the binary sum of the 7 lower bits of all the characters sent beforehand incl. STX and CR) | | | | | | | | | | | | | | | |

| Status word A | | | | | | | | | | | |
|---------------------|-----------|------------|---|---|---|---|---|---|---|---|---|
| Function | Selection | Status bit | | | | | | | | | |
| | | 6 | 5 | 4 | 3 | 2 | 1 | 0 | | | |
| Decimal position | X00 | 0 | 1 | | | 0 | 0 | 0 | | | |
| | X0 | | | | | | | | 0 | 1 | |
| | X | | | | | | | | 0 | 1 | 0 |
| | 0.X | | | | | | | | 0 | 1 | 1 |
| | 0.0X | | | | | | | | 1 | 0 | 0 |
| | 0.00X | | | | | | | | 1 | 0 | 1 |
| | 0.000X | | | | | | | | 1 | 1 | 0 |
| | 0.0000X | | | | | | | | 1 | 1 | 1 |
| Numerical increment | X1 | | | 0 | 1 | | | | | | |
| | X2 | | | 1 | 0 | | | | | | |
| | X5 | | | 1 | 1 | | | | | | |

| Status word B | |
|------------------------|-----|
| Function/Value | Bit |
| Gross/Net: Net = 1 | 0 |
| Sign: Negative = 1 | 1 |
| Overload/Underload = 1 | 2 |
| Movement = 1 | 3 |
| lb/kg: kg = 1 | 4 |
| 1 | 5 |
| Power up = 1 | 6 |

| Status word C | | | | |
|----------------------------|---|---|----|-----|
| Function/Value | | | | Bit |
| kg/lb | g | t | oz | |
| 0 | 1 | 0 | 1 | 0 |
| 0 | 0 | 1 | 1 | 1 |
| 0 | 0 | 0 | 0 | 2 |
| Print request = 1 | | | | 3 |
| Extended = 1 | | | | 4 |
| 1 | | | | 5 |
| Tare manually, only kg = 1 | | | | 6 |

4.3 MMR interface commands

The device supports the command set MMR (**METT**LER **MultiR**ange). This command set is compatible to the weighing terminals ID1 and ID3. For new installations we recommend the SICS command set, refer to Section 4.1.

4.3.1 Available MMR commands

| Com- mand | Meaning |
|--------------|--|
| AR | Read application block |
| AW | Write application block |
| D | Describe display |
| RO | Switch on the keyboard |
| R1 | Switch off the keyboard |
| S | Transmit stable weight value |
| SI | Transmit weight value immediately |
| SIR | Transmit weight value immediately and repeat |
| SR | Transmit stable weight value and repeat |
| SX | Transmit stable data record |
| SXI | Transmit data record immediately |
| SXIR | Transmit data record immediately and repeat |
| T | Taring |
| U | Switch over weight unit |
| Z | Setting to zero |

4.3.2 Syntax and formats

Commands have to be entered as ASCII characters and completed with C_{RLF}.

The following ASCII characters are available: 20 hex/32 dec ... 7F hex/127 dec.

Command format when transmitting weight values

| Identification | _ | Weight value | _ | Unit | Limit |
|--|-------|---|-------|---|------------------|
| String of characters for specification of command (1 ... 4 characters) | Blank | 1 ... 8 digits, Number of digits variable | Blank | 1 ... 3 characters, Number of characters variable | C _{RLF} |

Response format when transmitting weight values

| Identification | _ | Weight value | _ | Unit | Limit |
|---|-------|--|-------|--|------------------|
| String of characters for specification of the response (2 ... 3 characters) | Blank | 10 digits, right-justified, fill with blanks | Blank | 3 characters, left-justified, fill with blanks | C _{RLF} |

Example

Tare specification command T_13.295_kg

Tare specification response TBH_ _ _ _ 13.295_kg_

4.3.3 Error messages

Error messages consist of 2 characters and the delimiter C_{RLF}.

| Error message | Meaning | Description |
|---------------|--------------------|--|
| ET | Transmission error | Error in the received bit sequence, e.g. parity error, missing stop bit |
| ES | Syntax error | The received character string cannot be processed, e.g. command does not exist |
| EL | Logic error | Command cannot be executed, command is not supported on this application level |

4.3.4 Available application blocks

The device disposes of the following application blocks. The numbers of application blocks that can be written are printed in **bold**.

| No. | Content |
|------------|------------------------|
| 002 | Current program number |
| 003 | <STX> |
| 004 | <ETX> |
| 006 | <CR><LF> |
| 007 | Gross, 2nd unit |
| 008 | Net, 2nd unit |
| 009 | Tare, 2nd unit |
| 011 | Gross, 1st unit |
| 012 | Net, 1st unit |
| 013 | Tare, 1st unit |
| 014 | Display contents |
| 016 | Dynamic weighing |

5 Event and error messages

| Error | Cause | Remedy |
|----------------------------------|--|--|
| Display dark | <ul style="list-style-type: none"> • Back lighting set too dark • No mains voltage • Unit switched off • Mains cable not plugged in • Brief fault | <ul style="list-style-type: none"> → Set back lighting (b.LIGHT) brighter → Check mains → Switch on unit → Plug in mains plug → Switch device off and back on again |
| Insufficient load L _ _ _ _ J | <ul style="list-style-type: none"> • Load plate not on the scale • Weighing range not reached | <ul style="list-style-type: none"> → Place load plate on the scale → Set to zero |
| Overload r - - - - 7 | <ul style="list-style-type: none"> • Weighing range exceeded | <ul style="list-style-type: none"> → Unload scale → Reduce preload |
| - - - - - | <ul style="list-style-type: none"> • Result not yet stable | <ul style="list-style-type: none"> → If necessary, adjust vibration adapter or weigh dynamically |
| - - n 0 - - | <ul style="list-style-type: none"> • Function not permissible | <ul style="list-style-type: none"> → Unload scale and set to zero |
| r - n 0 - 7 L - n 0 - J | <ul style="list-style-type: none"> • Zeroing not possible with overload or insufficient load | <ul style="list-style-type: none"> → Unload scale |
| Err 6 | <ul style="list-style-type: none"> • No calibration | <ul style="list-style-type: none"> → Unplug the mains plug then plug it back in; switch unit off and then back on in battery mode → Calibrate scale → Call METTLER TOLEDO Service |
| Err 17 | <ul style="list-style-type: none"> • Printout not yet ended | <ul style="list-style-type: none"> → End printout → Repeat required action |
| Err 18 | <ul style="list-style-type: none"> • Switching the weighing unit impermissible during dynamic weighing | <ul style="list-style-type: none"> → End dynamic weighing |
| Err 30 | <ul style="list-style-type: none"> • No IDNet scale found | <ul style="list-style-type: none"> → Check connectors and cabling → Call METTLER TOLEDO service |

| Error | Cause | Remedy |
|--------------------------|--|--|
| Err 31 | <ul style="list-style-type: none"> • Data communication with IDNet scale faulty | <ul style="list-style-type: none"> → Remove and plug the power plug back in. In case of battery operation switch the device off and on again → Call METTLER TOLEDO service |
| Err 32 | <ul style="list-style-type: none"> • Restart error | <ul style="list-style-type: none"> → Remove and plug the power plug back in. In case of battery operation switch the device off and on again → Call METTLER TOLEDO service |
| Err 33 | <ul style="list-style-type: none"> • Weighing error | <ul style="list-style-type: none"> → Remove and plug the power plug back in. In case of battery operation switch the device off and on again → Call METTLER TOLEDO service |
| Err 53 | <ul style="list-style-type: none"> • EAROM checksum error | <ul style="list-style-type: none"> → Unplug the mains plug then plug it back in; switch unit off and then back on in battery mode → Call METTLER TOLEDO Service |
| Weight display unstable | <ul style="list-style-type: none"> • Restless installation location • Draft • Restless weighing sample • Contact between weighing pan and/or weighing sample and surroundings • Mains fault | <ul style="list-style-type: none"> → Adjust vibration adapter → Avoid drafts → Weigh dynamically → Remedy contact → Check mains |
| Incorrect weight display | <ul style="list-style-type: none"> • Incorrect zeroing • Incorrect tare value • Contact between weighing pan and/or weighing sample and surroundings • Scale tilted | <ul style="list-style-type: none"> → Unload scale, set to zero and repeat weighing operation → Clear tare → Remedy contact → Level scale |

6 Technical data and accessories

6.1 Technical data

6.1.1 General data

| IND429 / IND429xx / BBA429 | |
|-----------------------------------|--|
| Applications | <ul style="list-style-type: none"> • Weighing • Dynamic weighing |
| Settings | <ul style="list-style-type: none"> • Resolution can be selected • Weighing unit can be selected: g, kg, oz, lb, t • Taring function: Manual, automatic, next tare • Automatic zero compensation mode during switching on and during operation • Filter for adapting to the environmental conditions (vibration adapter) • Filter for adapting to the weighing mode, e.g. dispensing (weighing process adapter) • Switch-off function, sleep mode for power-operated devices, energy saving mode for storage battery operation • Display illumination |
| Display | <ul style="list-style-type: none"> • LCD liquid crystal display, digit height 16 mm, backlighting |
| Keyboard | <ul style="list-style-type: none"> • Tactile-touch membrane keypad • Scratch-resistant labelling |
| Housing | <ul style="list-style-type: none"> • Stainless steel 1.4301 or AISI 304 • For dimensions, see Page 46 |
| Net weight | <ul style="list-style-type: none"> • IND429/IND429xx with AC power supply unit approx. 2.2 kg • IND429/IND429xx with storage battery approx. 2.8 kg • BBA429-A with AC power supply unit approx. 9.0 kg • BBA429-A with storage battery approx. 9.6 kg • BBA429-BB with AC power supply unit approx. 12.1 kg • BBA429-BB with storage battery approx. 12.7 kg |
| Protection type (DIN 40050) | <ul style="list-style-type: none"> • IP69K |

| IND429 / IND429xx / BBA429 | |
|---|--|
| Mains connection | <p>Direct connection to power supply (supply voltage fluctuation not exceeding $\pm 10\%$ of the rated voltage)</p> <ul style="list-style-type: none"> • IND429 weighing terminal: Rated voltage 100 ... 240 VAC / 47 ... 63 Hz / 300 mA • IND429xx weighing terminal: Rated voltage 230 VAC $\pm 10\%$ / 47 ... 63 Hz / 300 mA • BBA429 compact scale Rated voltage 100 ... 240 VAC / 47 ... 63 Hz / 300 mA |
| Storage battery operation | <p>Supply at device: 24 VDC / 1.0 A</p> <p>If the supply voltage is interrupted, the scale switches automatically over to storage battery operation</p> <p>For operating life, see Section 6.1.2.</p> |
| Ignition protection type IND429xx (to IEC 60079-15) | <ul style="list-style-type: none"> • Hazardous area Zone 2: Device category II 3G EEx nA II T4, Temperature range $-10\text{ }^{\circ}\text{C}$... $+40\text{ }^{\circ}\text{C}$ / $14\text{ }^{\circ}\text{F}$... $104\text{ }^{\circ}\text{F}$ • Hazardous area Zone 22: Device category II 3D IP66 T 70°C |
| Ambient conditions | <ul style="list-style-type: none"> • Application in interiors • Height up to 2,000 m • Temperature range Class III $-10\text{ }^{\circ}\text{C}$... $+40\text{ }^{\circ}\text{C}$ / $14\text{ }^{\circ}\text{C}$... $104\text{ }^{\circ}\text{F}$ • Temperature range Class II $0\text{ }^{\circ}\text{C}$... $+40\text{ }^{\circ}\text{C}$ / $32\text{ }^{\circ}\text{C}$... $104\text{ }^{\circ}\text{F}$ • Installation/overvoltage category II • Pollution degree 2 • Relative humidity up to max. 80 %, non-condensing |
| Interfaces | <ul style="list-style-type: none"> • 1 RS232 interface integrated • 1 further optional interface possible |
| Technical data for analog scales | <p>For technical data of the analog scales to be connected to IND429 / IND429xx please refer to the "IND4x9 / BBA4x9" installation instructions.</p> <p>For technical data of the weighing platform used at BBA429 please refer to the PBA430 operating instructions.</p> |

6.1.2 Operating life with storage battery

The operating life during storage battery operation differs depending on the intensity of use, the configuration and the connected scale.

The following approximate values apply with activated background lighting and with standard RS232 interface.

| Scale | Conditions | Duration |
|---|--|----------|
| Scale with 1 DMS weighing cell (e.g. BBA429) | 10 % operating time 90 % power-off mode | 120 h |
| | Continuous operation | 12 h |
| Scale with 4 DMS weighing cells | 10% operating time 90% power-off mode | 90 h |
| | Continuous operation | 9 h |
| K line | 10% operating time 90% power-off mode | 70 h |
| | Continuous operation | 7 h |

Any additional optional equipment reduces the operating life correspondingly.

6.1.3 IND429 / IND429xx weighing terminal dimensions

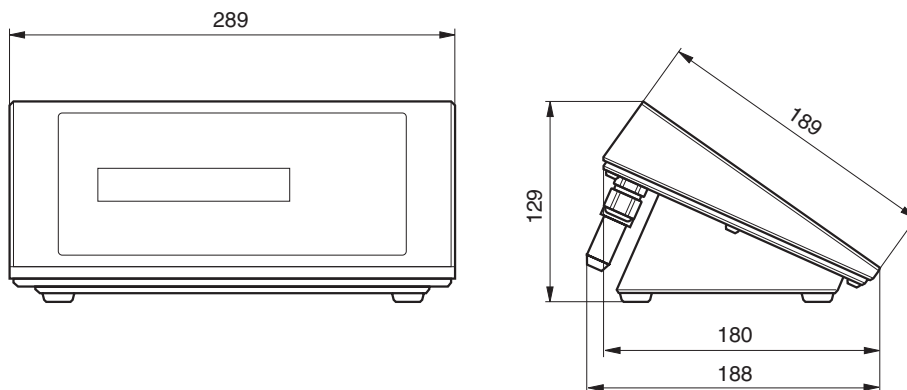

Dimensions in mm

6.1.4 BBA429 compact scale dimensions

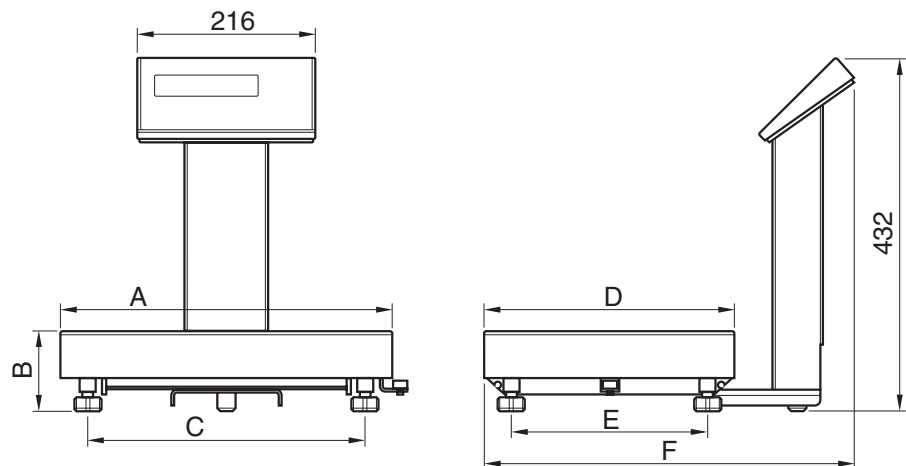

Dimensions in mm

| Model | A | B | C | D | E | F |
|-------------|-----|-------|-----|-----|-----|-----|
| BBA429-A... | 300 | 102.5 | 235 | 240 | 175 | 380 |
| BBA429-BB | 400 | 104.5 | 335 | 300 | 235 | 450 |

6.1.5 Interface connections

The device can be equipped with a maximum of 2 communication interfaces. The following combinations are possible:

| | COM1 | COM2 |
|------------------------|-----------|-------------|
| Standard | RS232 | – |
| Standard + RS232 | RS232 | RS232 |
| Standard + RS422/485 | RS422/485 | RS232 |
| Standard + Ethernet | RS232 | Ethernet |
| Standard + USB | RS232 | USB |
| Standard + Digital I/O | RS232 | Digital I/O |
| Standard + WLAN | RS232 | WLAN |

6.2 Accessories



| Designation | Order number |
|--|--------------|
| GA46 thermal printer, RS232, 2.5 m cable and connector incl., not for a hazardous area | 00 505 471 |
| GA46 thermal printer, RS232, 0.4 m cable and connector incl., not for a hazardous area | 00 507 229 |
| GA46-W thermal printer, take-up device/protective hood, RS232, 2.5 m cable and connector incl., not for a hazardous area | 00 505 799 |
| GA46-W thermal printer, take-up device/protective hood, RS232, 0.4 m cable and connector incl., not for a hazardous area | 00 507 230 |
| Secondary display ADI419 (display without background lighting, stainless steel, IP69K, RS232, 3 m cable incl.), not for a hazardous area | 22 013 962 |
| Secondary display ADI419-B (display with background lighting, stainless steel, IP69K, RS232, 3 m cable incl.), not for a hazardous area | 22 014 022 |
| RS232 cable for SICS second scale (3 m, 8 pin <-> 9 pin Sub D connector) | 22 006 795 |
| RS232 cable for PC (3 m, 8 pin <-> 9 pin Sub D socket) | 00 504 376 |
| RS232 mating plug, 8 pin | 00 503 756 |
| RS422/RS485 cable (3 m, 6 pin <-> open ends) | 00 204 933 |
| RS422/RS485 mating plug, 6 pin | 00 204 866 |
| Ethernet 10/100 Base T twisted pair cable (5 m -> 8 pin RJ45) | 00 205 247 |
| Ethernet 10/100 Base T twisted pair cable (20 m -> 8 pin RJ45) | 00 208 152 |
| USB adapter cable (0.2 m -> USB Series A socket) | 22 006 268 |
| USB adapter cable (3 m -> USB Series A socket) | 22 007 713 |
| Relay box for digital I/O option, not for a hazardous area | 22 011 967 |
| Connection cable Digital I/O option with relay box (10 m) | 00 504 458 |
| Digital I/O mating plug, 19 pin | 00 504 461 |
| Protective hood for IND4x9 terminals (set with 3 pieces) not for a hazardous area | 22 013 963 |
| Protective hood for BBA4x9 compact scales (set with 3 pieces) | 22 013 992 |
| Stand, stainless steel, for IND4x9 and PBA430, height 330 mm | 22 013 964 |
| Stand, stainless steel, for IND4x9 and PBA430, height 660 mm | 22 013 965 |

| Designation | Order number |
|---|---------------------|
| Stand, stainless steel, for IND4x9 and KA, KB, MA, MB and DB weighing platforms | 22 014 836 |
| Bench stand, stainless steel, for IND4x9, suitable for mounting frame 503632 and 504854 | 22 014 835 |
| Floor stand, stainless steel, for IND4x9 | 22 014 834 |
| Stand base for floor stand | 22 011 982 |
| Wall adapter, stainless steel, for IND4x9, tiltable | 22 013 966 |
| Wall bracket, stainless steel, for IND4x9, rotatable and tiltable | 22 014 833 |
| GA46 mounting plate, stainless steel, for bench stand, floor stand and wall bracket | 22 011 985 |
| External storage battery for BBA4x9, stainless steel, IP69K (without charger) | 22 013 988 |
| Charger for version with internal or external storage battery (incl. power cable) | 22 014 056 |

7 Appendix

7.1 Safety checks

The device has been tested by accredited inspection bodies. It has passed the safety checks listed below and carries the relevant test symbols. Production is subject to production monitoring by the inspection offices.

| Country | Test symbol | Standard |
|-----------------|--|--|
| Canada USA |  | CAN/CSA-C22.2 No. 1010.1-92 (für IND429) CAN/CSA-C22.2 No. 1010.1-04 (für BBA429) UL Std. No. 61010A-1 |
| Other countries | CB Scheme | IEC/EN61010-1:2001 |
| EU | ATEX prototype test certificate  | only for IND429xx: EN 60079-15:2003 EN 50281-1-1:1998 |

7.2 Tests for utilisation in hygienically sensitive areas

Weighing terminal IND429 and compact scale BBA429 have been assessed by the EHEDG (European Hygienic Engineering and Design Group) and the NSF (National Sanitation Foundation).

Both institutes certify the fulfilment of the hygienic requirements for easy cleaning (Hygienic Design Criteria).

EHEDG The EHEDG is an association of device manufacturers, firms in the foodstuff industry, research institutes and health authorities. It was founded in 1989 with the aim of promoting the hygienically faultless manufacturing and packaging of foodstuffs. A positive expertise of the device by the EHEDG has taken place.

A corresponding report is available on the Internet under www.mt.com.

NSF NSF is an independent NGO founded in 1944 in the USA. Corresponding regulations were published for the use of devices in the foodstuff industry. The device fulfils the NSF criteria C-2 (Special Equipment and/or Devices) for use in the foodstuff industry.

The corresponding certificate is available on the Internet under www.mt.com.

7.3 Working to GMP (Good Manufacturing Practice)

Weighing terminal IND429 and compact scale BBA429 were evaluated by the Steinbeis-Transferinstitut Berlin with the following result:

"The device is excellently suited for GMP working to EC-GMP Guideline Annex 15 and PIC/S Guideline PI 006-1."

The evaluation encompasses the following points:

- Requirements for surfaces in the pharmaceutical production
- Ability to be cleaned
- Calibration
- Documentation with regard to qualification

The corresponding certificate is available on the Internet under www.mt.com.

7.4 Tables of geo values

For weighing instruments verified at the manufacturer's, the geo value indicates the country or geographical zone for which the instrument is verified. The geo value set in the instrument (e.g. "Geo 18") appears briefly after switch-on or is specified on a label.

Table **GEO VALUES 3000e** shows the geo values for European countries.

Table **GEO VALUES 6000e/7500e** shows the geo values for different gravitation zones.

7.4.1 GEO VALUES 3000e, OIML Class III (European Countries)

| Geographical latitude | Geo value | Country |
|-----------------------|-----------|----------|
| 46°22' – 49°01' | 18 | Austria |
| 49°30' – 51°30' | 21 | Belgium |
| 41°41' – 44°13' | 16 | Bulgaria |
| 42°24' – 46°32' | 18 | Croatia |
| 48°34' – 51°03' | 20 | Czechia |
| 54°34' – 57°45' | 23 | Denmark |
| 57°30' – 59°40' | 24 | Estonia |
| 59°48' – 64°00' | 25* | Finland |
| 64°00' – 70°05' | 26 | |
| 41°20' – 45°00' | 17 | France |
| 45°00' – 51°00' | 19* | |
| 47°00' – 55°00' | 20 | Germany |
| 34°48' – 41°45' | 15 | Greece |
| 45°45' – 48°35' | 19 | Hungary |

| Geographical latitude | Geo value | Country |
|------------------------------|------------------|----------------|
| 63°17' – 67°09' | 26 | Iceland |
| 51°05' – 55°05' | 22 | Ireland |
| 35°47' – 47°05' | 17 | Italy |
| 55°30' – 58°04' | 23 | Latvia |
| 47°03' – 47°14' | 18 | Liechtenstein |
| 53°54' – 56°24' | 22 | Lithuania |
| 49°27' – 50°11' | 20 | Luxemburg |
| 50°46' – 53°32' | 21 | Netherlands |
| 57°57' – 64°00' | 24* | Norway |
| 64°00' – 71°11' | 26 | |
| 49°00' – 54°30' | 21 | Poland |
| 36°58' – 42°10' | 15 | Portugal |
| 43°37' – 48°15' | 18 | Romania |
| 47°44' – 49°46' | 19 | Slovakia |
| 45°26' – 46°35' | 18 | Slovenia |
| 36°00' – 43°47' | 15 | Spain |
| 55°20' – 62°00' | 24* | Sweden |
| 62°00' – 69°04' | 26 | |
| 45°49' – 47°49' | 18 | Switzerland |
| 35°51' – 42°06' | 16 | Turkey |
| 49°00' – 55°00' | 21* | United Kingdom |
| 55°00' – 62°00' | 23 | |

* factory setting

7.4.2 GEO VALUES 6000e/7500e OIML Class III (Height ≤1000 m)

| Geographical latitude | Geo value |
|------------------------------|------------------|
| 00°00' – 12°44' | 5 |
| 05°46' – 17°10' | 6 |
| 12°44' – 20°45' | 7 |
| 17°10' – 23°54' | 8 |
| 20°45' – 26°45' | 9 |
| 23°54' – 29°25' | 10 |
| 26°45' – 31°56' | 11 |
| 29°25' – 34°21' | 12 |
| 31°56' – 36°41' | 13 |
| 34°21' – 38°58' | 14 |
| 36°41' – 41°12' | 15 |
| 38°58' – 43°26' | 16 |
| 41°12' – 45°38' | 17 |
| 43°26' – 47°51' | 18 |
| 45°38' – 50°06' | 19 |
| 47°51' – 52°22' | 20 |
| 50°06' – 54°41' | 21 |
| 52°22' – 57°04' | 22 |
| 54°41' – 59°32' | 23 |
| 57°04' – 62°09' | 24 |
| 59°32' – 64°55' | 25 |
| 62°09' – 67°57' | 26 |
| 64°55' – 71°21' | 27 |
| 67°57' – 75°24' | 28 |
| 71°21' – 80°56' | 29 |
| 75°24' – 90°00' | 30 |

7.5 FCC

This equipment has been tested and found to comply with the limits for a Class A digital device, pursuant to both Part 15 of the FCC Rules and the radio interference regulations of the Canadian Department of Communications. These limits are designed to provide a reasonable protection against harmful interference when the equipment is operated in a commercial environment. This equipment generates, uses and can radiate radio frequency energy and, if not installed and used in accordance with the user manual, may cause harmful interference to radio communications. Operation of this equipment in a residential area is likely to cause harmful interference, in which case the user will be required to correct the interference at his own expense.

Cet appareil a été testé et s'est avéré conforme aux limites prévues pour les appareils numériques de class A et à la partie 15 des règlements FCC et à la réglementation des radio-Interférences du Canadian Department of Communications. Ces limites sont destinées à fournir une protection adéquate contre les interférences néfastes lorsque l'appareil est utilisé dans un environnement commercial. Cet appareil génère, utilise et peut radier une énergie à fréquence radioélectrique; il est en outre susceptible d'engendrer des interférences avec les communications radio, s'il n'est pas installé et utilisé conformément aux instructions du mode d'emploi. L'utilisation de cet appareil dans les zones résidentielles peut causer interférences néfastes, auquel cas l'exploitant sera amené à prendre les dispositions utiles pour palier aux interférence à ses propres frais.

8 Index

- A**
 Accessories 48
 Additional equipment 8
 Adjustment 25
 Ambient conditions 45
 Analog scale 45
 Applications 44
 Average 17, 29
- C**
 Calibration 25
 Chain tare 17
 Cleaning 18
 Compact scale 8
 Continuous mode 37
- D**
 Device overview 9
 Digital I/O 47
 Dimensions 46, 47
 Display 10
 Display accuracy 25
 Display precision 27
 Dynamic weighing 17, 29
- E**
 Error messages 42
 Ethernet 47
 Explosion protected weighing terminals 5
 External power supply 8, 14, 49
- F**
 Filter 26, 28
- H**
 Hygienically sensitive areas . 7, 18, 50
- I**
 Ignition protection type 45
 Interface commands
 MMR 39
 Interface protocol 37, 39
 Interfaces
 Configuring 30
 Connections 8, 47
- K**
 Keyboard 11
- M**
 Mains connection 12, 13, 45
 Menu
 Application 29
 Communication 30
 Diagnosis 34
 Operation 20
 Overview 22
 Scale 25, 27
 Terminal 29
 Menu structure 21
- O**
 Operator menu 20
 Options 32
- P**
 Password 20
 Power supply 12, 13
 Protocol 18
- R**
 Reset
 Application 29
 Interface 32
 Scale 26, 28
 Terminal 30
 RS232 45, 47
 RS422 47
 RS422/RS485 36
 RS485 47
- S**
 Safety checks 50
 Safety instructions 5
 SICS commands 35
 Storage battery operation 13, 46
 Supervisor menu 20
 Switching off 15
 Switching on 15
- T**
 Tare
 Automatic 16
 Chain tare 17
 Clearing 16
 Terminal settings 29
 TOLEDO Continuous 37
- U**
 USB 47
- V**
 Verification 14
- W**
 Weighing terminal 8
 Weighing unit 25, 27
 WLAN 32, 47
- Z**
 Zeroing 15



22013801B

Subject to technical changes © Mettler-Toledo (Albstadt) GmbH 05/08 Printed in Germany 22013801B

Mettler-Toledo (Albstadt) GmbH

D-72458 Albstadt

Tel. ++49-7431-14 0, Fax ++49-7431-14 232

Internet: <http://www.mt.com>