

# ICS425 / ICS429 / ICS435 / ICS439

## Weighing systems

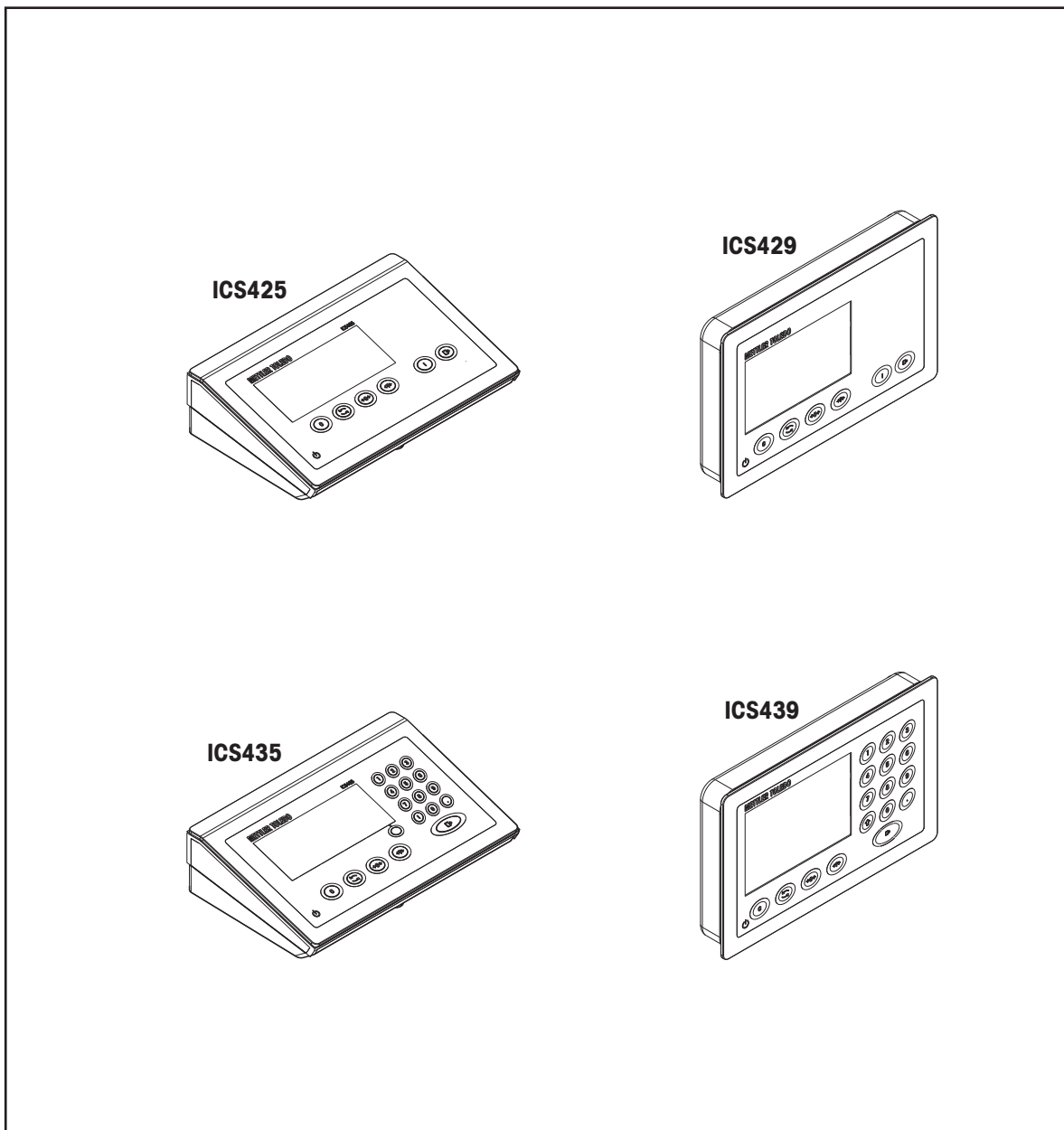

**METTLER TOLEDO**



# METTLER TOLEDO Service

Congratulations on choosing the quality and precision of METTLER TOLEDO. Proper use of your new equipment according to this Manual and regular calibration and maintenance by our factory-trained service team ensures dependable and accurate operation, protecting your investment. Contact us about a service agreement tailored to your needs and budget. Further information is available at [www.mt.com/service](http://www.mt.com/service).

There are several important ways to ensure you maximize the performance of your investment:

- 1 **Register your product:** We invite you to register your product at [www.mt.com/productregistration](http://www.mt.com/productregistration) so we can contact you about enhancements, updates and important notifications concerning your product.
- 2 **Contact METTLER TOLEDO for service:** The value of a measurement is proportional to its accuracy – an out of specification scale can diminish quality, reduce profits and increase liability. Timely service from METTLER TOLEDO will ensure accuracy and optimize uptime and equipment life.
  - ⇒ **Installation, Configuration, Integration and Training:** Our service representatives are factory-trained weighing equipment experts. We make certain that your weighing equipment is ready for production in a cost effective and timely fashion and that personnel are trained for success.
  - ⇒ **Initial Calibration Documentation:** The installation environment and application requirements are unique for every industrial scale so performance must be tested and certified. Our calibration services and certificates document accuracy to ensure production quality and provide a quality system record of performance.
  - ⇒ **Periodic Calibration Maintenance:** A Calibration Service Agreement provides on-going confidence in your weighing process and documentation of compliance with requirements. We offer a variety of service plans that are scheduled to meet your needs and designed to fit your budget.



# Table of Contents

<b>1</b>	<b>Introduction</b>	<b>3</b>
1.1	Safety instructions.....	3
1.2	Presentation.....	4
1.3	Commissioning.....	10
<b>2</b>	<b>Operation</b>	<b>14</b>
2.1	Switching on/off.....	14
2.2	Straight weighing.....	14
2.3	Switching units.....	14
2.4	Zeroing / Zero point correction.....	15
2.5	Weighing with tare.....	15
2.6	Displaying information.....	17
2.7	Printing results.....	17
2.8	Average (dynamic) weighing.....	18
2.9	Working with identifications.....	18
2.10	Cleaning.....	19
2.11	Verification test.....	20
<b>3</b>	<b>Settings in the menu</b>	<b>21</b>
3.1	Menu overview.....	21
3.2	Operating the menu.....	21
3.3	Scale menu block.....	24
3.4	Application menu block.....	32
3.5	Terminal menu block.....	33
3.6	Communication menu block.....	37
3.7	Maintenance menu block.....	44
<b>4</b>	<b>Event and error messages</b>	<b>46</b>
4.1	Error conditions.....	46
4.2	Errors and warnings.....	47
4.3	Smart weighing counter / spanner icon.....	48
4.4	Service information.....	48
<b>5</b>	<b>Technical data and accessories</b>	<b>49</b>
5.1	Devices for dry environment.....	49
5.2	Devices for wet environment.....	56
5.3	General technical data.....	62
<b>6</b>	<b>Appendix</b>	<b>63</b>
6.1	Metrological information.....	63
6.2	Table of Geo Code values.....	63
6.3	Disposal.....	66
6.4	Protocol printouts.....	67
	<b>Index</b>	<b>69</b>



# 1 Introduction

## 1.1 Safety instructions

### General

- Do not use the device in a hazardous environment. Special devices are available in our range of products for hazardous environments.
- The safety of the device cannot be ensured if it is not operated in accordance with these operating instructions.
- Only authorized personnel may open the device.



### CAUTION

#### **Risk of personal injury, damage to property, erroneous operation or voided warranty**

Use only genuine METTLER TOLEDO accessories and cable assemblies with this product. Use of unauthorized or counterfeit accessories or cable assemblies may result in voided warranty, improper or erroneous operation, or damage to property (including the unit) and personal injury.

### **Devices with protection level IP5x or IP65**

Devices with protection level IP54 or IP65 are protected against dust and splashing of water respectively dust-tight and protected from water jets according to EN 60529. They are suitable for use in dusty environments and brief contact with liquids.

- Ensure that the device is dried off after coming into contact with liquid.
- Do not use the device in environments with a risk of corrosion.
- Do not flood the device or submerge it in liquid.

### **Devices with built-in power supply unit**

- Ensure that the power socket outlet for the device is earthed and easily accessible, so that it can be de-energized rapidly in emergencies.
- Ensure that the supply voltage at the installation site lies within the range of 100 V to 240 V.
- Ensure that there is a space of at least 3 cm (1.25") at the rear in order to prevent the power cable from being bent too strongly.
- Check the power cable regularly for damage. If it is damaged, immediately disconnect the device from the power supply unit.

### **Devices with built-in storage battery**

- Only use storage batteries from the manufacturer.
- Do not use the battery charger in humid or dusty rooms or below 0 °C (32 °F) ambient temperature.
- After the storage battery has been charged, the cover cap of the charging socket on the device must be closed.



### WARNING

#### **Explosion hazard**

Use only genuine METTLER TOLEDO replacement battery packs and rechargers as listed in the applicable User Manual. Use of anything other than genuine METTLER TOLEDO battery packs or chargers may cause fire or explosion resulting in serious personal injury up to and including death or property damage.

Batteries must be disposed of properly in accordance with local environmental and any other applicable regulatory requirements. Do not discard in normal domestic waste.

### Compact scales / Terminal and platform combinations

- Avoid falling and shock loads as well as any impact from the side.
- The maximum static safe load must never be exceeded. Observe the operation limits, see technical data of the connected weighing platform.

## 1.2 Presentation

### 1.2.1 Type overview

**ICS425 / ICS429 / ICS435 / ICS439** weighing terminals vary in the following:

	<b>ICS425</b>	<b>ICS429</b>	<b>ICS435</b>	<b>ICS439</b>
<b>Numeric keypad</b>	–	–	x	x
<b>Environment</b>	dry	wet	dry	wet
<b>Available as compact scale</b>	x	–	x	–
<b>Available as terminal and platform combination</b>	x	x	x	x

### Default equipment

Each weighing terminal offers the following interfaces:

- 1 serial RS232 interface
- 1 scale interface

### Optional equipment

The weighing terminals can be equipped or retrofitted with an additional interface:

- RS232
- RS422/485
- USB Device
- USB Host
- Ethernet
- WLAN
- Digital I/O



## 1.2.2 Display

To meet your special requirements, different display layouts are available in the menu under `Terminal -> Device -> Display -> Display layout`.

### Straight weighing display – Default layout

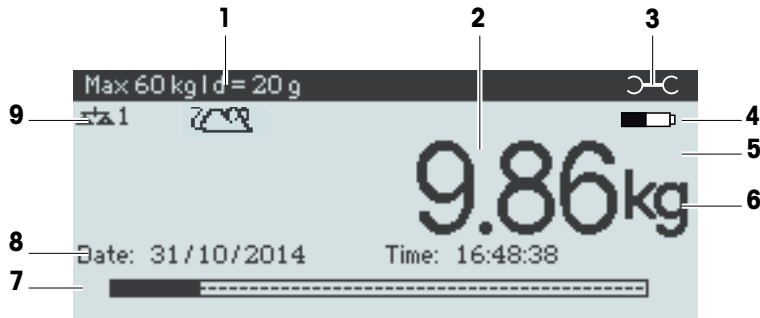

- |   |  |  |
|---|--|--|
| 1 | Metrological data                                  | For details see following table          |
| 2 | Weight value with star, sign and stability monitor | For details see following table          |
| 3 | Spanner icon: service needed                       | For details see Event and error messages |
| 4 | Battery symbol                                     |  |
| 5 | Net/Gross  |  |
| 6 | Unit   |  |
| 7 | Bargraph   |  |
| 8 | Auxiliary data line                                | The contents is defined in the menu      |
| 9 | Symbol and info line                               | For details see following table          |

### Straight weighing display – 3-line mode



### Straight weighing display – Big font mode



## Straight weighing display – Bargraph

The device offers a bargraph indicating the scale capacity.



The bargraph indicates roughly which part of the scale capacity is already occupied and what capacity is still available.

In the example above, approximately 3/4 of the scale capacity is occupied, although the applied net weight isn't really high. The reason therefore could be a high tare weight.

## Metrological data line

**i** The metrological data is stored in the weighing platform. The weighing terminal only serves as indicator.

In the metrological data line the following information is displayed:

Symbol	Information	Remark
<b>I1</b> , <b>I2</b> , <b>I3</b> , <b>I4</b>	Accuracy classes	Displayed only if the scale is approved according to the Weights and Measures guidelines
<b>W1</b> , <b>W2</b> , <b>W3</b>	Weighing range information	For multi range devices only and if the scale is approved according to the Weights and Measures guidelines
<b>Max</b> , <b>cap</b>	Maximum capacity	<b>cap</b> for NTEP only
<b>Min</b>	Minimum capacity	Displayed only if the scale is approved according to the OIML Weights and Measures guidelines
<b>e =</b>	Approved resolution	Displayed only if the scale is approved (OIML)
<b>d =</b>	Display resolution	Please note for approved scales: <b>OIML</b> : Displayed only if d is different from e <b>NTEP</b> : Always displayed
<b>Approved scale</b>	Approved weighing device	Metrology display disabled for SICS scales, e.g., BBK422. Weights and Measures data must be indicated on a label near the weight display.





## Weight value

The weight value can be marked with the following symbols:





Symbol	Information	Remark
<b>*</b>	Calculated weight value	For example for average weighing results
<b>—</b>	Sign	For negative weight values
<b>○</b>	Stability monitor	For unstable weight values
<b>1.234<sub>3</sub> kg</b>	Non-approved last digit with e>d	For approved scales only The example shows the weight value for a scale with e=1g and d=0.1g. The last, smaller digit is not approved.

## Symbols and info line

In the symbols and info line the following information can be displayed:

Symbol	Information	Remark
<->	Weighing range	For multi range or multi interval scales only
	Weight below minimum weight	MinWeigh must be activated in the menu
	Average weighing	Average must be activated in the menu
	Automatic taring	Auto Tare must be activated in the menu
	Automatic clearing of the tare weight	A-Clear Tare must be activated in the menu
<b>&gt;0&lt;</b>	Center of zero indication	Availability depending on local Weights and Measures regulations
<b>Fact</b>	Fact needs to be performed	Fact = Fully automatic calibration test. When Fact is displayed: Ensure that the weighing platform is empty and wait until the calibration test is done automatically. For <b>ICS4_5k-.../f</b> compact scales only.

### 1.2.3 Keyboard

Key	Name	Function in the operating mode	Function in the menu
	Power	<ul style="list-style-type: none"> <li>Switching on and off</li> <li>Cancelling editing</li> </ul>	<ul style="list-style-type: none"> <li>Cancelling editing</li> <li>Exiting menu</li> </ul>
<b>C</b>	Clear	<ul style="list-style-type: none"> <li>Clearing tare</li> <li>Leaving info page</li> </ul>	<ul style="list-style-type: none"> <li>Clearing value</li> <li>Clearing digit</li> </ul>
	Switch	<ul style="list-style-type: none"> <li>Switching over weight unit</li> </ul>	<ul style="list-style-type: none"> <li>Re-editing</li> </ul>
	Zero	<ul style="list-style-type: none"> <li>Setting scale to zero</li> <li>Clearing tare</li> </ul>	—
	Tare	<ul style="list-style-type: none"> <li>Taring scale</li> <li>Clearing previous tare</li> </ul>	—
<b>i</b>	Info	<ul style="list-style-type: none"> <li>Activating info screen</li> <li>Proceeding to the next info line / info page</li> <li>Freezing and releasing startup screen</li> </ul>	—
	Transfer	<ul style="list-style-type: none"> <li>Transferring data to a printer or computer</li> </ul>	<ul style="list-style-type: none"> <li>Confirming entry/selection</li> </ul>

## 1.2.4 Connections

### ICS4\_5 weighing terminal for dry environments

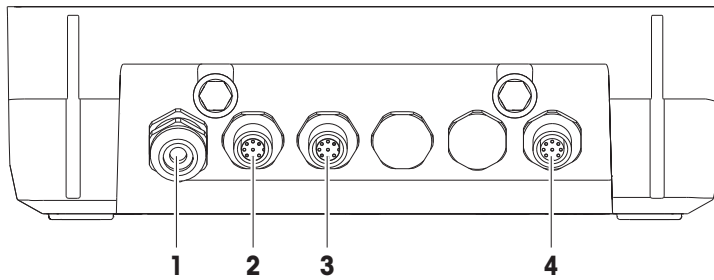

- |   |                                     |   |                                     |
|---|-------------------------------------|---|-------------------------------------|
| 1 | AC power supply or battery charging | 2 | Standard interface COM1 (RS232)     |
| 3 | Optional interface COM2             | 4 | Weighing platform connection SCALE1 |

### ICS4\_9 weighing terminal for wet environments

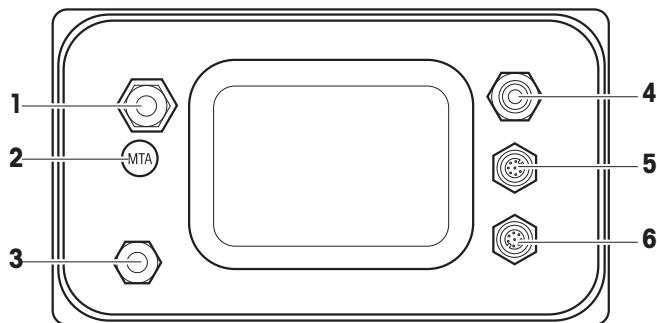

- |   |                                 |   |                                     |
|---|---------------------------------|---|-------------------------------------|
| 1 | Weighing platform connection    | 2 | Verification securing seal          |
| 3 | Pressure compensation           | 4 | AC power supply or battery charging |
| 5 | Standard interface COM1 (RS232) | 6 | Optional interface COM2             |

### ICS4\_9a-.../c

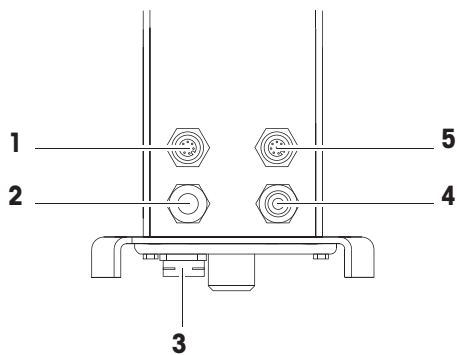

- |   |                                 |   |                                     |
|---|---------------------------------|---|-------------------------------------|
| 1 | Optional interface COM2         | 2 | Analog weighing platform connection |
| 3 | Pressure compensation           | 4 | AC power supply or battery charging |
| 5 | Standard interface COM1 (RS232) |   |                                     |

The verification securing seal is applied directly on the weighing terminal.

## 1.3 Commissioning

### 1.3.1 Selecting the location

The correct location is crucial for the accuracy of the weighing results.

- 1 Select a stable, vibration-free and, if possible, a horizontal location for the weighing platform.
  - ⇒ The ground must be able to safely bear the weight of the fully loaded weighing platform.
- 2 Observe the following environmental conditions:
  - ⇒ No direct sunlight
  - ⇒ No strong drafts
  - ⇒ No excessive temperature fluctuations

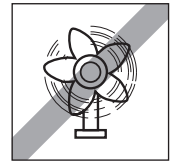
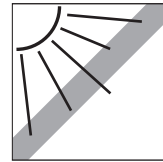
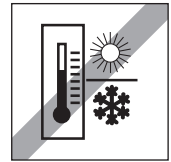
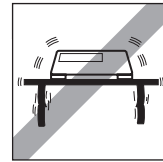

### 1.3.2 Levelling

#### Levelling of weighing platforms

Only weighing platforms that have been levelled precisely horizontally, provide accurate weighing results. Weights and Measures approved weighing platforms have a level bubble to simplify levelling.

- Turn the adjustable feet of the weighing platform until the level bubble's air bubble is inside the inner circle.

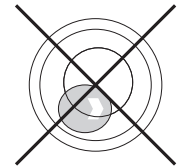
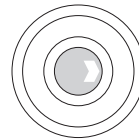

#### Levelling of compact scales ICS4\_5-.../f

On compact scales levelling can be done in an easier way.

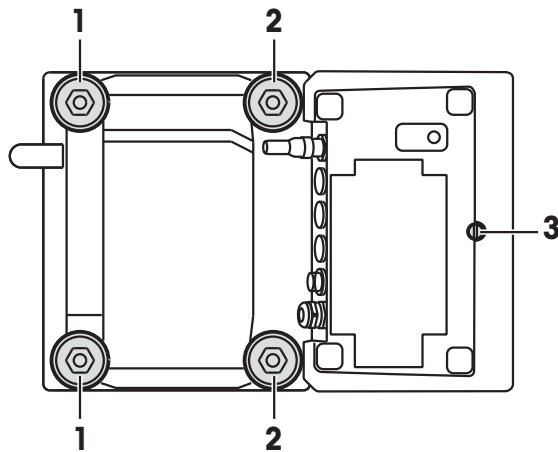

- 1 Turn the compact scale upside down.
- 2 Screw in the 2 adjustable feet (2) on the terminal side of the weighing platform.
- 3 Turn over the compact scale to its normal position.
- 4 Level the compact scale by turning the other 2 adjustable feet (1) of the weighing platform until the level bubble is inside the inner circle.
- 5 Screw out the feet (2) of the weighing platform until they have contact with the table.

**i** The adjustable foot (3) of the weighing terminal is screwed out for 7 mm at the factory and needs not be adjusted for levelling.

### 1.3.3 Weighing platform connection

#### Analog weighing platforms

- Call the METTLER TOLEDO service technician to connect an analog weighing platform to the **ICS4\_5g / ICS4\_9g** weighing terminal.

#### Weighing platforms with digital scale interface

- Connect the weighing platform connector to the **ICS4\_5i / ICS4\_9i** or **ICS4\_5s / ICS4\_9s** weighing terminal.



- If you have ordered an approved weighing system consisting of an **ICS4\_5s** weighing terminal and an approved PBD555 weighing platform, the approval was done in the factory (not for the US market).
- You can disconnect the weighing platform from the **ICS4\_5s / ICS4\_9s** or **ICS4\_5i / ICS4\_9i** weighing terminal of an approved weighing system without violating the approval. If another weighing platform is connected to the weighing terminal, the system is not approved. If the weighing platform of the approved system is connected again, the approval is valid again.
- If you have ordered an approved weighing system consisting of an **ICS4\_5s / ICS4\_9s** weighing terminal and an approved PBK/PFK weighing platform, the approval was done in the factory (not for the US market).
- If you have connected a non-approved weighing platform and want to have the system approved, call the **METTLER TOLEDO** service technician.

### 1.3.4 Power supply connection



#### CAUTION

##### Risk of electric shock!

- 1 Before connecting the power supply, check whether the voltage value printed on the label corresponds to your local system voltage.
- 2 Do not, under any circumstances, connect the device if the voltage value on the label deviates from the local system voltage.
- 3 Make sure the weighing platform has reached room temperature before switching on the power supply.

- Plug the power plug into the power socket.
- ⇒ After it has been connected, the device runs a self-test. The device is ready to operate when zero appears on the display.

### 1.3.5 Handling the storage battery

#### Battery symbol

The battery symbol shows the current charging status of the storage battery.



- One segment corresponds with approx. 25 % capacity.
- If the symbol flashes, the storage battery has to be charged.
- During charging the segments are "running" until the battery is fully charged and all segments light up continuously.

Note the following when operating a device with a built-in storage battery:

- Before the first operation charge the storage battery for at least 3 hours.
- The operating life depends on the intensity of use, the configuration, and the connected scale. For details concerning **ICS4\_5**, see "[Operating life with battery ▶ Page 52]", or concerning **ICS4\_9**, see "[Operating life with battery ▶ Page 58]".
- The charging time of the storage battery amounts to 4 to 5 hours. The storage battery is protected against overcharging.
- The storage battery has a service life of 500 to 1,000 charging/discharging cycles.



#### **CAUTION**

**Charging the storage battery below 0 °C (32 °F) or above 40 °C (104 °F) is prevented by the charging electronics!**

- Make sure that the temperature is within the range of 0 °C to 40 °C (32 °F to 104 °F) to charge the storage battery.



#### **CAUTION**

**Danger of soiling because the charger for the storage battery is not protected according to IP69K!**

- 1 Do not charge the device in humid or dusty rooms.
- 2 After the storage battery has been charged, close the cover cap of the charging socket on the device.

#### Recommended use of the storage battery

The characteristics mentioned above are only valid if the following recommendations are observed:

- Change the battery as soon as the warning message "Low battery" appears and the battery symbol starts flashing. When the message appears, you still have enough time (at least 10 minutes), to complete your current task.
- For optimum battery performance, operate the device with built-in storage battery at an ambient temperature range of 10 °C to 30 °C (50 °F to 86 °F). This also applies to discharging the battery.



### Changing battery (ICS4\_5 only)

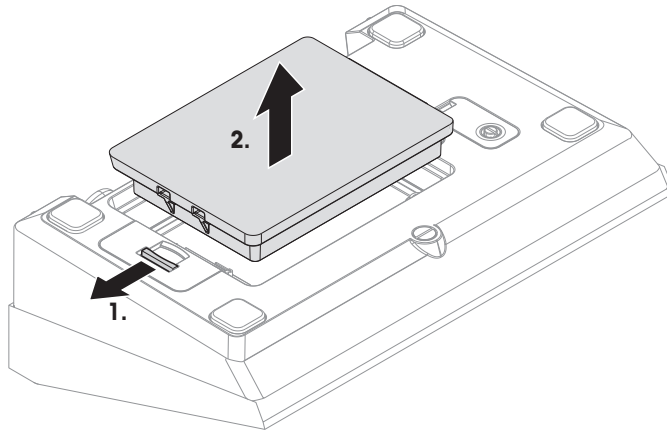

- 1 Unlock the battery by moving the slider away from the battery and remove the discharged battery.
- 2 Insert the fully charged battery and secure it by moving the slider towards the battery.



With optional IP65 protection, the battery is not accessible from the outside. Please call the **METTLER TOLEDO** service technician.

### 1.3.6 Use in hygienically sensitive areas

**ICS4\_9** weighing terminals are easy to clean and are designed to be used in the food industry.

#### **ICS4\_9 features**

- Protection degree IP68/69k
- Terminal housing and load plate made of stainless steel
- No open threads
- No screws with recesses
- Keypad made of PET with a smooth surface
- Reduced horizontal surfaces
- Continuous welding seams



The standard load cell is made of aluminium. As an option, stainless steel potted and hermetically sealed load cells are available.

## 2 Operation

### 2.1 Switching on/off

#### Switching on

- Press .

⇒ For a few seconds the device shows a start-up screen with device name, software version, serial number of the weighing terminal and the Geo Code value.



- You can freeze the start-up screen by pressing .
- When you start a compact scale, the metrology line shows whether it is approved or not. If you have ordered an approved weighing system, approval has been done in the factory already (not for the US market).
- With **ICS4\_5k-.../f** compact scales ensure that the device is at room temperature before switching on. **To ensure accurate weighing results, wait 15 minutes after switching on before starting weighing operation.**

#### Switching off

- Press .

⇒ Before the display goes out, `-OFF-` appears briefly.

#### Resetting

- Press and hold  for approx. 5 seconds.

⇒ The device is switched off.

### 2.2 Straight weighing

- 1 Place weighing sample on the scale.
- 2 Wait until the stability monitor  disappears.
- 3 Read the weighing result.

### 2.3 Switching units

If an additional second weight unit is configured in the menu, it is possible to switch back and forth between the two weight units.

- Press .

⇒ The weight value is displayed in the second unit.



- Possible units are g, kg, oz, lb, lb-oz, t.
- When in the menu `Scale -> Disp. unit & res. -> Unit roll` is set to `On`, the weight value can be displayed in all available weight units by repeatedly pressing .

## 2.4 Zeroing / Zero point correction

Zeroing corrects the influence of slight changes on the load plate or minor deviations from the zero point.

### Manual

- 1 Unload scale.
- 2 Press **→0←**.
  - ⇒ Zero appears in the display.

### Automatic

In case of non-approved scales, the automatic zero point correction can be deactivated in the menu or the zero range can be changed. Approved scales are set fixed at 0.5 d per second.



- The zero function is only available within a limited weighing range.
- After zeroing the scale, the whole weighing range is still available.

## 2.5 Weighing with tare

### 2.5.1 Taring

- Place the empty container on the scale and press **→T←**.
  - ⇒ The zero display and the symbol **NET** appear.
  - ⇒ The tare weight remains stored until it is cleared.

### 2.5.2 Clearing the tare

- Press **C**.
  - ⇒ The symbol **NET** goes out, the gross weight appears in the display.



If the symbol  is displayed, i.e., the tare function `Auto clear tare` is activated in the `Scale` menu, the tare weight is automatically cleared as soon as the scale is unloaded.

### 2.5.3 Automatic clearing the tare

A tare weight is automatically cleared when the scale is unloaded.

#### Prerequisite

The symbol  is displayed, i.e., the tare function `Auto clear tare` is activated in the `Scale` menu.



The tare weight must be heavier than 9 scale divisions.

### 2.5.4 Automatic taring

If you place a weight on an empty scale, the scale tares automatically and the symbol **NET** is displayed.

#### Prerequisite

The symbol  is displayed, i.e., the tare function `Auto tare` is activated in the `Scale` menu.



The weight to be tared automatically, e.g., packaging material, must be heavier than 9 scale divisions.

## 2.5.5 Chain tare

With this function it is possible to tare several times if, e.g., cardboard is placed between individual layers in a container.

- The tare function `Chain tare` is activated in the `Scale` menu.

1 Place the first container or packaging material on the scale and press **→T←**.

⇒ The packaging weight is automatically saved as the tare weight, the zero display and the symbol **NET** appear.

2 Load the sample and read/print out the result.

3 Place the second container or packaging material on the scale and press **→T←** again.

⇒ The total weight on the scale is saved as the new tare weight. The zero display appears.

4 Load the sample in the second container and read/print the result.

5 Repeat steps 3 and 4 for other containers.

## 2.5.6 Tare preset

For established container weights enter the tare weight numerically or via barcode / SICS command. Thus, you do not have to tare the empty container.



The entered tare weight is valid until a new tare weight is entered or the tare weight is cleared.

### Tare preset with numeric entry

1 Enter the known tare weight and press **→T←** to confirm.

⇒ The weight display shows the negative tare weight and the symbol **NET** appears.

2 Place the full container on the weighing platform.

⇒ The net weight is displayed.



Tare preset with numeric entry is only available for **ICS435** and **ICS439**.

### Tare preset with barcode entry

- For barcode use, `Tare preset` is selected as destination for external input in the menu under `Communication -> COMx -> External input -> Destination`.

1 Enter the known tare weight via barcode.

⇒ The weight display shows the negative tare weight and the symbol **NET** appears.

2 Place the full container on the weighing platform.

⇒ The net weight is displayed.

### Tare preset with SICS command from a connected computer

1 Enter the known tare weight on the computer using the SICS command `TA_Value_Unit`.

⇒ The weight display shows the negative tare weight and the symbol **NET** appears.

2 Place the full container on the weighing platform.

⇒ The net weight is displayed.

## 2.6 Displaying information

Up to 5 different items can be configured in the menu for the **i** key. Depending on the configuration in the menu under `Terminal -> Device -> Keyboard -> Info key`, the following data can be assigned in any order, e.g.,

- Date & Time
- Weight values
- Identifications
- Device information
- Serial numbers and software versions
- Network information

On the second and third info page, system and contact information can be displayed.

1 Press **i**.

⇒ The (first) info page is displayed.

2 Press **i** again.

⇒ The next info screen is displayed.

3 To leave the info screens, press **C**.

**i** An info screen is displayed until **i** is pressed again or until **C** is pressed.

## 2.7 Printing results

If a printer or computer is connected, weighing results and other information can be printed out or transferred to a computer.

– Press **↵**.

⇒ The defined data is printed out or transferred to the computer.

**i** The printout content can be defined in the menu under `Communication -> COMx -> Define Templates`. The template has to be assigned to the printout in the `Application` menu.

### Printing without pressing a key (clever print)

▪ In the menu `Application -> Clever print -> Activate` is set to `On`.

▪ To initiate the next printout, the weight must drop below the set threshold.

1 Put the weighing sample on the load plate.

⇒ When a stable weight value is reached, the result is printed automatically.

2 Remove the weighing sample from the load plate and load the next weighing sample.

⇒ When the weight value has dropped below the set threshold, the next stable weight value is printed automatically.

## 2.8 Average (dynamic) weighing

With the average weighing function, it is possible to weigh moving weighing samples such as animals. If this function is activated,  is displayed in the info line. With average weighing, the scale calculates the mean value from weighing operations within a certain time interval.

### Start via hard key

- Application -> Average Weighing -> Mode -> Print key (factory setting), Info key or Switch key is selected in the menu.
- Weighing sample heavier than 9 scale divisions.
  - 1 Place the weighing sample on the scale.
  - 2 Press the key defined in the menu to start average weighing.
    - ⇒ During average weighing, stars appear in the display, and the average result will be displayed with the symbol **\***.
  - 3 Unload the scale to begin a new average weighing operation.

### With automatic start

- Application -> Average -> Mode -> Auto is selected in the menu.
- Weighing sample heavier than 9 scale divisions.
  - 1 Place the weighing sample on the scale.
    - ⇒ Average weighing starts automatically.
    - ⇒ During average weighing, stars appear in the display, and the average result will be displayed with the symbol **\***.
  - 2 Unload the scale to start a new average weighing operation.

## 2.9 Working with identifications

Weighing series can be assigned with 3 identification numbers ID1, ID2 and ID3 with up to 40 numeric characters that are also printed out in the protocols. If, for example, a customer number and a batch number are assigned, it can be clearly seen in the protocol which batch was weighed for which customer.

### Barcode use (for one identification only)

- ID1, ID2 or ID3 is selected as destination for external input in the menu under Communication - COMx -> External input -> Destination.
- To display the identification in the auxiliary line, ID1, ID2 or ID3 has to be activated in the menu under Terminal -> Display -> Auxiliary line.
- Scan the ID.
  - ⇒ The ID is assigned to the following weighings until a new ID is scanned.

### Using SICS command set (up to three identifications)

- To display the identification in the auxiliary line, ID1, ID2 or ID3 has to be activated in the menu under Terminal -> Display -> Auxiliary line.
- Send the ID command (I12, I13 or I14) from a PC.
  - ⇒ The ID is assigned to the following weighings until a new ID is sent.

## 2.10 Cleaning



### **WARNING**

#### **Risk of electric shock**

- 1 Before cleaning, unplug the power plug in order to disconnect the terminal from the power supply.
- 2 Cover open connectors with protective caps.

#### **Cleaning of the ICS4\_5 (dry environments)**

- Clean the optional protective cover separately. The protective cover is dishwasher-safe.
- Take off the load plate and remove any dirt and foreign substances which may have collected underneath. Do not use any hard objects to prevent scratching the surface.
- Do not disassemble the weighing device.
- Remove any remaining detergent with a wet cloth.
- Observe all existing regulations on cleaning intervals and permissible cleaning agents.
- In case of a windshield, we recommend to clean it with a glass cleaner each day of usage in order to prolong the durability.

#### **Cleaning of the ICS4\_9 (wet environments)**

These devices are designed to be used in a wet environment. Depending on the environment and the cleaning procedures, we suggest appropriate weighing platforms with different types of load cells. The following table provides a detailed overview of recommended environments and suitable cleaning procedures.

	Terminal	Weighing platform		
	ICS4_9	Standard aluminium potted load cell	Option potted stainless steel load cell	Option hermetically sealed stainless steel load cell
IP rating	IP68/ IP69k	IP65	IP65/IP67	IP68/IP69k
<b>Environment</b>				
Short time wet (30 min / day)	x	x	x	x
Part time wet (120 min/day)	x	–	x	x
Permanently wet	x	–	–	x
<b>Cleaning procedure</b>				
Wet wipe down	x	x	x	x
Light hose down < 5 l/min, 20 kPa	x	x	x	x
Light wash down < 12.5 l/min, 30 kPa	x	–	x	x
Heavy wash down, high pressure water and steam jet up to 10000 kPa	x	–	–	x
<b>Cleaning detergents</b>				
Mild detergents	x	x	x	x
Other detergents in accordance with the manufacturer's specifications and instructions	x	–	–	x

- Clean the optional protective cover separately. The protective cover is dishwasher-safe.
- Replace the protective cover regularly.
- Take off the load plate and remove any dirt and foreign substances which may have collected underneath. Do not use any hard objects to prevent scratching the surface.
- Do not disassemble the weighing device.
- Remove any remaining detergent by rinsing with clear water.
- To prolong the lifetime of the load cell, dry it with a soft lint-free cloth immediately after cleaning.
- Observe all existing regulations on cleaning intervals and permissible cleaning agents.

#### **Cleaning of other weighing platforms not described in this user manual**

- Make sure to observe the cleaning instructions for the connected weighing platform. The weighing platform may not be designed for the environments and cleaning procedures described above!

## **2.11 Verification test**

The weighing instrument is verified if:

- the accuracy class is displayed in the metrological line,
- the approval readability is shown with "e = readability",
- it bears an official verification mark, e.g., the green M sticker (OIML),
- the validity is not expired.

The weighing instrument is also verified if:

- the metrological line shows "Approved scale",
- labels with the metrological data are placed near the weight display,
- the securing seal is not tampered with,
- it bears an official verification mark, e.g., the green M sticker (OIML),
- the validity is not expired.



The period of validity is country-specific. It is in the responsibility of the owner to renew verification in due time.

### **Strain gauge weighing platforms**

Strain gauge weighing platforms use a Geo Code to compensate gravitational influence. The manufacturer of the weighing instrument uses a defined Geo Code value for verification.

- 1 Check if the Geo Code in the instrument corresponds with the Geo Code value defined for your location.
  - ⇒ The Geo Code value is displayed when you switch on the instrument.
  - ⇒ The Geo Code value for your location is shown in the Appendix.
- 2 Call the **METTLER TOLEDO** service technician if the Geo Code values do not match.



## 3 Settings in the menu

### 3.1 Menu overview

In the menu, settings can be changed and functions can be activated. This enables adaptation to individual weighing requirements.

The menu consists of the following 5 main blocks containing various submenus on several levels which are described in the following sections.



- Scale
- Application
- Terminal
- Communication
- Maintenance

### 3.2 Operating the menu



#### 3.2.1 Calling up the menu and entering the password

The menu differentiates between 2 operating levels: Operator and Supervisor. The Supervisor level can be protected by a password. When the device is delivered, both levels are accessible without a password.

##### Operator menu

- 1 Press  and keep it pressed until **Enter code** appears.
- 2 Press  again.
  - ⇒ The menu item `Terminal` is displayed. Only parts of the submenu `Device` are accessible.

##### Supervisor menu

- 1 Press  and keep it pressed until **Enter code** appears.
- 2 Enter the password and confirm with .
  - ⇒ The first menu item `Scale` is highlighted.



- By default, no password is set. Therefore, confirm the password inquiry with  when you call up the menu for the first time.
- As long as no supervisor password is defined, operator access will offer the complete supervisor menu.
- If a password is not entered within a few seconds, the scale returns to the weighing mode.

##### Emergency password for Supervisor access to the menu

If a password has been issued for Supervisor access to the menu and you have forgotten it, you can still enter the menu:

- Press **→0←** three times and confirm with .

### 3.2.2 Display in the menu

Menu items are displayed together with their context.

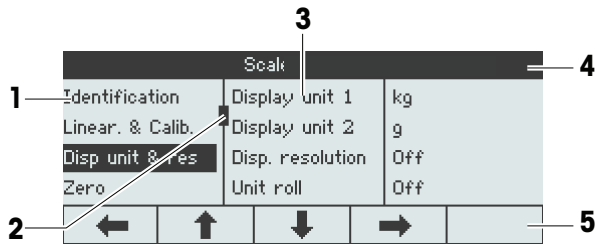







- 1 Menu items; the selected menu item is highlighted
- 2 Scroll flag, like, e.g., the scroll bar of your PC
- 3 Sub-menu items
- 4 Menu info line, i.e., menu path of the current menu item
- 5 Navigation info line: use the keys below to navigate the menu as indicated

#### Exiting the menu

- Press .
- ⇒ **Save settings?** is displayed.
- Press the key to save the menu changes and to return to the weighing mode.
- or
- Press the key for further menu settings.
- or
- Press the key to discard changes and return to the weighing mode.

### 3.2.3 Selecting and setting parameters in the menu

#### Example: Setting the average weighing mode to "Automatic"

- 1 In the menu start screen use  to select (highlight) the `Application` menu.  
The submenus are displayed in the middle column.
- 2 Press  to enter the `Application` menu.  
The current setting of the highlighted menu item is displayed in the right column.
- 3 Press  and then press  to open the `Avg. weighing` submenu.  
The possible settings of the selected menu item are displayed on the right side.
- 4 Press  to enter the `Mode` submenu.  
The setting of the average weighing mode has changed.
- 5 Press  to select (highlight) `Auto` and confirm selection with .

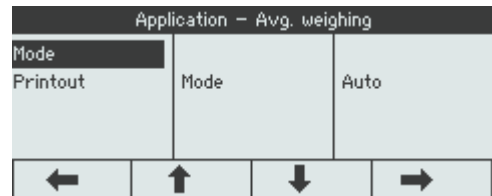
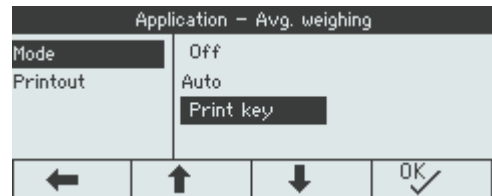
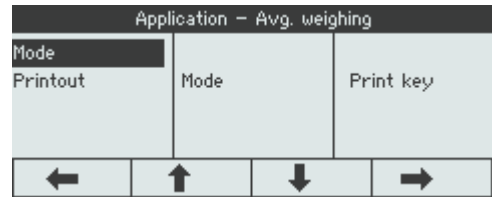
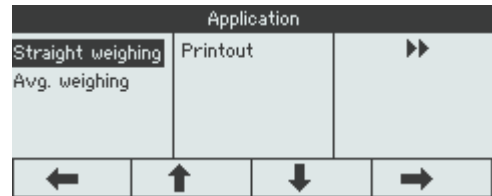
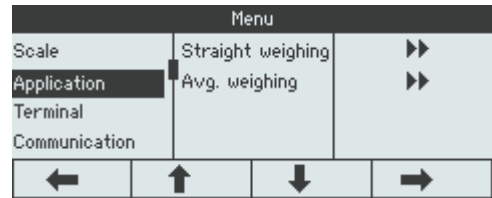

Should the settings of a menu item not be displayed on one page (e.g., all the info items), use  to proceed to the hidden items.

### 3.3 Scale menu block

#### 3.3.1 Scale menu overview

The `scale` menu depends on the connected load cell which is indicated on the type label.

Type	Load cell	Scale menu
<b>ICS4_5g / ICS4_9g</b>	Analog	[Analog scale menu ▶ Page 24]
<b>ICS4_5i / ICS4_9i</b>	IDNet	[IDNet scale menu block ▶ Page 29]
<b>ICS4_5s / ICS4_9s</b>	SICSpro	[Analog scale menu ▶ Page 24]
<b>ICS4_5k-.../f</b>	MonoBloc®	[Analog scale menu ▶ Page 24]

#### 3.3.2 Scale menu block (Analog / SICSpro)

##### Overview

Factory settings are printed in **bold** in the following overview.

Level 1	Level 2	Level 3	Level 4
Identification	Serial no. scale, Scale model, Scale location, Scale ID		
Linear. & Calib.	Last calibration		
	Start up FACT (for <b>ICS4_5k-.../f</b> compact scales only)	<b>On</b> , Off	
	Auto print calib.	<b>On</b> , Off	
	Perform calib.		
Disp. unit & res.	Display unit 1	g, <b>kg</b> , oz, lb, lb-oz, t	
	Display unit 2	<b>g</b> , kg, oz, lb, lb-oz, t	
	Disp. resolution		
	Unit roll	On, <b>Off</b>	
Zero	AZM	Off, <b>0.5d</b> , 1d, 2d, 5d, 10d	
Tare	Auto tare	On, <b>Off</b>	
	Chain tare	<b>On</b> , Off	
	Auto clear tare	On, <b>Off</b>	
Restart	On, Off		
Filter	Vibration	Low, <b>Medium</b> , High	
	Process	<b>Universal</b> , Dosing, Absolute	
	Stability	Fast, <b>Standard</b> , Precise	
MinWeigh	MinWeigh	On, <b>Off</b>	
FACT (for <b>ICS4_5k-.../f</b> compact scales only)	Temperature	Off, 1K, 2K, 3K	
	Time	Time 1, Time 2, Time 3	
	Days	Monday ... Sunday	<b>Off</b> , On
Reset	Perform reset?		

## Description

Identification	Displaying/setting scale identification data
Serial no. scale	Displaying the serial number of the weighing platform
Scale model	Displaying the scale type, e.g., PBD555 Available for <b>METTLER TOLEDO</b> scales only
Scale location	Entering the scale location, e.g., floor and room
Scale ID	Entering the scale identification, e.g., inventory number
Notes	<ul style="list-style-type: none"> <li>Scale location and Scale ID can be displayed in the auxiliary or info lines or printed out.</li> <li>Scale location and Scale ID can consist of up to 24 alphanumeric characters.</li> </ul>

Linear. & Calib	Linearization and calibration
Last calibration	Shows the date of the last calibration.
Start up FACT	When set to <b>On</b> , an internal calibration is performed every time the scale is switched on. It is recommended not to disable this setting if the scale will be moved to other locations.
Autoprint calib.	When set to <b>On</b> , a protocol is printed out automatically for each calibration process.
Perform calib.	<p><b>Important:</b> With <b>ICS4_5k-.../f</b> weighing terminals make sure that the scale has been switched on at least 15 minutes before performing linearization/calibration.</p> <ol style="list-style-type: none"> <li>Start calibration with <input type="text" value="OK"/>. ⇒ <b>Preload</b> is blinking.</li> <li>Ensure that the weighing platform is empty and confirm with <input type="text" value="OK"/>.</li> <li>If necessary, change the calibration weight value displayed using <input type="text" value="↓"/> / <input type="text" value="↑"/>.</li> <li>Put on the indicated calibration weight on the weighing platform and confirm with <input type="text" value="OK"/>.</li> <li>Remove the calibration weight and confirm with <input type="text" value="OK"/>.</li> </ol> <p>⇒ <b>Passed</b> is displayed briefly.</p>
Notes	<ul style="list-style-type: none"> <li>In order to achieve a particularly high precision, calibrate under full load.</li> <li>The calibration process can be aborted using <input type="text" value="ESC"/>.</li> <li>This menu item is not available for verified scales.</li> </ul>

<b>Disp. unit &amp; res.</b>	<b>Display units and resolution</b>
Display unit 1	Selecting weighing unit 1
Display unit 2	Selecting weighing unit 2, different from unit 1
Display resolution	Selecting readability (resolution). The possible settings depend on the connected scale. When set to <i>off</i> , only the default resolution of the weighing platform is available.
Unit roll	When set to <i>on</i> , the weight value can be displayed in all available units with  .
Notes	<ul style="list-style-type: none"> <li>In case of verified scales, individual sub-items of the <i>Display/Units &amp; Resolution</i> menu item may not be available or only to a limited extent, depending on the respective country.</li> <li>On dual-range/dual interval scales, resolutions marked with <b>I&lt;-&gt;I 1/2</b> are divided into 2 weighing ranges/intervals, e.g., 2 x 3000 d.</li> <li>On triple-range/multi interval scales, resolutions marked with <b>I&lt;-&gt;I 1/2/3</b> are divided into 3 weighing ranges/intervals, e.g., 3 x 3000 d.</li> </ul>

<b>Zero</b>	<b>Automatic zero setting</b>
<b>AZM</b>	<b>Automatic Zero Maintenance</b>
On/Off	Switching automatic zero maintenance on/off.
Off; 0.5 d; 1 d; 2 d; 5 d; 10 d	Selecting zeroing range in digits per second.
Note	On verified scales, this menu item does not appear.



<b>Tare</b>	<b>Tare function</b>
Auto tare	Switching on/off automatic taring <i>Auto tare = On</i> : When a load is placed on the scale and the gross weight exceeds 9 d, the weight is tared automatically.
Chain tare	Switching on/off chain tare <i>Chain tare = On</i> : It is possible to tare several times if, e.g., cardboard is placed between individual layers in a container.
Auto clear tare	Switching on/off automatic clearing of the tare weight <i>Auto clear tare = On</i> : When the load is removed and the weight drops below 9 d, the tare weight is cleared automatically.

<b>Restart</b>	<b>Automatic saving of zero point and tare value</b>
Restart	When set to <i>on</i> , the last zero point and the tare value are saved. After switching off/on or after a power interruption, the device continues to work with the saved zero point and tare value.

<b>Filter</b>	<b>Filter settings</b>
<b>Vibration</b>	<b>Adaptation to ambient conditions</b>
Low	Very steady and stable environment. The scale works very rapidly, but is very sensitive to external influences.
Medium	Normal environment. The scale operates at medium speed.
High	Unstable environment. The scale works more slowly, but is less sensitive to external influences.
<b>Process</b>	<b>Adaptation to the weighing process</b>
Universal	Universal setting for all weighing samples and normal weighing goods.
Dosing	Dispensing liquid or powdery weighing samples (only for certain weighing platforms, e.g., PBK9-series / PFK9-series).
Absolute	For solid bodies under extreme conditions, e.g., strong vibrations.
<b>Stability</b>	<b>Adjusting the stability detector</b>
	The slower the scale works, the greater the reproducibility of the weighing results.
Fast	The scale operates very fast.
Standard	The scale operates at medium speed.
Precise	The scale operates with the greatest possible reproducibility.

<b>MinWeigh</b>	<b>MinWeigh function</b>
MinWeigh	Switching MinWeigh function on/off When set to $\text{On}$ and if the weight on the scale drops below the stored minimum weight, $\text{⚠}$ will appear in the symbols and info line.
Note	Before you can use this function, the <b>METTLER TOLEDO</b> service technician has to determine and enter a minimum weight value.

<b>FACT</b>	<b>Fully automatic calibration test (for ICS4_5k-.../f compact scales only)</b>
<b>Temperature</b>	<b>Setting the temperature difference for automatic adjustment.</b>
Off	Switching off automatic adjustment in case of a temperature difference.
1K, 2K, 3K	Automatic adjustment in case of the selected temperature change.
<b>Time</b>	<b>Setting up to 3 times per day for automatic adjustment.</b>
Time 1, Time 2, Time 3	Entering the times for the automatic adjustment (hours, minutes in 24 h format). To deactivate Time 2 and Time 3, set them to 00:00:00.
<b>Days</b>	<b>Setting the days of the week for automatic adjustment.</b>
Monday ... Sunday	On all days which are set to $\text{On}$ , the automatic adjustment will be performed.
Note	FACT is executed under the following conditions: <ul style="list-style-type: none"> <li>• No key has been pressed for 3 minutes. <ul style="list-style-type: none"> <li>– and –</li> </ul> </li> <li>• The displayed weight value is smaller than 30 d and stable.</li> </ul>

Reset	Resetting the scale settings to factory settings
Perform reset?	<p>– Confirm with <input type="checkbox"/>  to reset the scale menu settings.</p> <p><b>For ICS4_5k-.../f compact scales only</b></p> <ol style="list-style-type: none"> <li>1 Press <b>Reset</b> for 5 seconds. <ul style="list-style-type: none"> <li>⇒ <b>Reset User Calibration</b> is displayed.</li> </ul> </li> <li>2 Confirm with <input type="checkbox"/>  to reset the user calibration.</li> </ol>



### 3.3.3 IDNet scale menu block

#### Overview

Level 1	Level 2	Level 3
Display unit & Resolution	Display unit 2	<b>g</b> , kg, oz, lb, t
	Unit roll	On, <b>Off</b>
Zero	AZM	Off, <b>0.5d</b> , 1d, 2d, 5d, 10d
Tare	Auto tare	On, <b>Off</b>
	Auto clear tare	On, <b>Off</b> , 9 d
	Chain tare	<b>On</b> , Off
Restart	On, <b>Off</b>	
Filter	Vibration	Stable, <b>Normal</b> , Unstable
	Process	Finefill, <b>Universal</b> , Absolute
	Stability	ASD = 0, 1, <b>2</b> , 3, 4, 5
Update	The possible settings depend on the connected scale	
MinWeigh	Function	On, <b>Off</b>
	MinWeigh value	
Reset	Perform reset?	

#### Description

Identification	Displaying/setting scale identification data
Serial no. scale	Displaying the serial number of the weighing platform
Scale model	Displaying the scale type, e.g., PBD555 Available for <b>METTLER TOLEDO</b> scales only
Scale location	Entering the scale location, e.g., floor and room
Scale ID	Entering the scale identification, e.g., inventory number
Notes	<ul style="list-style-type: none"> <li>Scale location and Scale ID can be displayed in the auxiliary or info lines or printed out.</li> <li>Scale location and Scale ID can consist of up to 24 alphanumeric characters.</li> </ul>

Display unit & Resolution	Setting the weighing units
Unit 2	Selecting weighing unit 2, different from unit 1.
Unit roll	When set to <b>On</b> , the weight value can be displayed in all available units with  .
Notes	<ul style="list-style-type: none"> <li>In case of verified scales, individual sub-items of the <code>Display unit &amp; Resolution</code> menu item may not be available or only to a limited extent, depending on the respective country.</li> <li>On dual-range/dual interval scales, resolutions marked with <b>I&lt;-&gt;I 1/2</b> are divided up into 2 weighing ranges/intervals, e.g., 2 x 3000 d.</li> <li>On triple-range/multi interval scales, resolutions marked with <b>I&lt;-&gt;I 1/2/3</b> are divided up into 3 weighing ranges/intervals, e.g., 3 x 3000 d.</li> </ul>

<b>Zero</b>	<b>Automatic zero setting</b>
<b>AZM</b>	<b>Automatic Zero Maintenance</b>
On/Off	Switching automatic zero maintenance on/off.
0.5d, 1d, 2d, 5d, 10d	Selecting the threshold for automatic zero setting.
Notes	<ul style="list-style-type: none"> <li>• On verified scales, this menu item does not appear.</li> <li>• The effective range of the zero update mode can only be set by the <b>METTLER TOLEDO</b> service technician.</li> </ul>

<b>Tare</b>	<b>Tare function</b>
<b>Auto tare</b>	Switching on/off automatic taring.
On	When a load is placed on the scale and the gross weight exceeds 9 d, the weight is tared automatically.
Off	No automatic taring.
<b>Auto clear tare</b>	Configuring the automatic clearing of the tare weight.
On	The tare weight is automatically cleared if the gross weight is 0 or below zero.
Off	No automatic clearing of the tare weight.
9 d	The tare weight is automatically cleared if the gross weight is within +/- 9 display steps.
<b>Chain tare</b>	Switching on/off chain tare.
On	It is possible to tare several times if, e.g., cardboard is placed between individual layers in a container.
Off	Taring is only possible once.

<b>Restart</b>	<b>Automatic saving of zero point and tare value</b>
Restart	When set to $\text{On}$ , the last zero point and the tare value are saved. After switching off/on or after a power interruption, the device continues to work with the saved zero point and tare value.

<b>Filter</b>	<b>Filter settings</b>
<b>Vibration</b>	<b>Adaptation to ambient conditions</b>
Low	Very steady and stable environment. The scale works very rapidly, but is very sensitive to external influences.
Medium	Normal environment. The scale operates at medium speed.
High	Unstable environment. The scale works more slowly, but is insensitive to external influences.
<b>Process</b>	<b>Adaptation to the weighing process</b>
Dosing	Dispensing of liquid or powdered weighing samples manually.
Universal	Universal setting for all weighing samples and normal weighing goods.
Absolute	No adaptation, to perform automated filling processes, e.g., with PLC.
<b>Stability</b>	<b>Adjusting the stability detector</b>
	The slower the scale works, the greater the reproducibility of the weighing results.
ASD = 0	Stability detector switched off. Only possible for non-verified scales.
ASD = 1	Rapid display, good reproducibility
...	...
ASD = 4	Slow display, excellent reproducibility

<b>Update</b>	<b>Setting the display speed of the weight display</b>
xx UPS	Selecting the number of updates per second (UPS).
Notes	<ul style="list-style-type: none"> <li>This menu is only displayed if the Update function is supported by the connected scale.</li> <li>The possible settings depend on the connected scale.</li> </ul>

<b>MinWeigh</b>	<b>MinWeigh function</b>
MinWeigh	Switching MinWeigh function on/off When set to <b>On</b> and if the weight on the scale drops below the stored minimum weight,  will appear in the symbols and info line and the display color will change.
Note	Before you can use this function, the <b>METTLER TOLEDO</b> service technician has to determine and enter a minimum weight value.



<b>Reset</b>	<b>Resetting the scale settings to factory settings</b>
Perform reset?	– Confirm resetting with <input type="checkbox"/>  <input type="checkbox"/> .

### 3.4 Application menu block

#### 3.4.1 Application → Straight weighing

Printout	Defining printer and template in the straight weighing application
COM1, COM2	<b>Selecting the COM port for the desired printer</b> E.g., COM1 for printout to a PC and the optional COM2 for printout on an office (ASCII) printer
Off	No printout on this COM port
Standard	Printout with the standard template on the selected printer
Template 1 ... Template 5	Assigning a customer template to the selected printer
Notes	<ul style="list-style-type: none"> <li>• Templates 1 ... 5 can be defined under <code>Communication → Define templates</code>.</li> <li>• This menu item is only available if a COM port is set to Print mode.</li> <li>• There are 5 more templates available (Template 6 ... Template 10). Please ask your <b>METTLER TOLEDO</b> service technician to configure these templates or create them by yourself using the DatablCS software (<a href="http://www.mt.com/ind-datablcs">www.mt.com/ind-datablcs</a>), if desired.</li> </ul>

#### 3.4.2 Application → Average weighing

Mode	Selecting mode for determining the average weight for an unstable load (dynamic weighing)
Auto	Calculating average weight with automatic start of the weighing cycle
Print key Info key Switch key	Calculating average weight with manual start of the weighing cycle via the selected key: Print key  , Info key  , Switch key 
Printout	Defining printer and template in the average weighing application
	See Application → Straight weighing

#### 3.4.3 Application → Clever print

Clever print	Settings for printing without pressing a key
Activate	When set to <code>On</code> , the result is automatically printed when the weight between two weighings has dropped below the threshold.
Threshold	Enter threshold for unloading the scale between two weighings. Possible settings: 0.0 kg ... max. capacity Factory setting: 0.0 kg

#### 3.4.4 Application → Reset

Reset	Resetting the application settings to factory settings
Perform reset?	– Confirm resetting with <input type="checkbox"/>  .

## 3.5 Terminal menu block

### 3.5.1 Terminal menu overview

The `Terminal` menu block consists of the following main subblocks, which are described in detail in the following.

- Device
- Access
- Reset

Factory settings are printed in **bold** in the following overview.

### 3.5.2 Terminal → Device

#### Overview

Level 1	Level 2	Level 3	Level 4	Level 5
Region	Language	<b>English</b> , US English, Deutsch, Français, Italiano, Español, Chinese, ...		
	Date format	MM/DD/YY, MM/DD/YYYY, MMM/DD/YYYY, DD/MM/YY, DD/MMM/YYYY, YY/MM/DD, YYYY/MMM/DD, YYYY/MM/DD, <b>DD/MM/YYYY</b>		
	Set date	Set year		
		Set month		
		Set day		
	Time format	24:MM, 12:MM tt, <b>24:MM:SS</b> , 12:MM:SS tt		
Set time	Set hour			
	Set minutes			
Energy save	Backlight	<b>On</b> , 5 seconds, 10 seconds, 15 seconds, 30 seconds		
	Power off	<b>Off</b> , 1 minute, 3 minutes, 5 minutes, 15 minutes, 30 minutes		
Identification	Terminal loc.			
	Terminal ID			
Display	Display layout	<b>Default</b> , 3-lines mode, Big font mode		
	Contrast	1 ... <b>5</b> ... 10		
	Brightness	1 ... <b>5</b> ... 10		
	Weight hold	<b>0</b> (s) ... 10 (s)		
	Auxiliary line	Not used, <b>Date &amp; Time</b> (for battery devices incl. remaining capacity in % and in hours), Gross, Net, Tare, High resolution (not available for approved scales), ID1, ID2, ID3, Bargraph, Temperature (for <b>ICS4_5k-.../f</b> only)		

Level 1	Level 2	Level 3	Level 4	Level 5
Keyboard	Hard keys	Power, Clear, Switch, Info, Transfer, Numeric keys	<b>On</b> , Off	
	Info key	Page 1	Item 1 ... Item 5	Not used, <b>Date &amp; Time</b> , Highres & net (not available for approved scales), Gross, Net, Tare, ID1, ID2, ID3, Terminal ID, Terminal loc., Terminal model, SNo. Terminal, Terminal FW, SNo. Scale, Scale FW, Temperature (for <b>ICS4_5k-.../f</b> only), MinWeigh, IP address, Subnet mask, Gateway, USB version, Consecutive number
		Page 2 & 3	Info page 2	Off, <b>System info</b> , Contact info
			Info page 3	<b>Off</b> , System info, Contact info
	Beeper	<b>On</b> , Off		
Message time	1 s, <b>2 s</b> , ... 6 s			
Battery	Charge strategy	<b>Full</b> , Preservation		
Timeout	Mode	Off, Rental, Rental info		
	Set date	Set year, Set month, Set day		



## Description

Region	Country specific settings
<b>Language</b>	<b>Selecting the language of the operator interface.</b> We will expand the available languages continuously.
<b>Date format</b>	<b>Selecting the date format.</b>
<b>Set date</b>	<b>Entering the date in the selected format.</b>
Set month	Entering the month in the selected format.
Set day	Entering the day in the selected format.
<b>Time format</b>	<b>Selecting the time format.</b>
<b>Set time</b>	<b>Entering the time in the selected format.</b>
Set hour	Entering the hour in the selected format.
Set minutes	Entering the minutes.

Energy save (Operator access)	Setting the energy saving mode
<b>Backlight</b>	Settings for switching off the backlighting
On	Backlight always on
5 seconds ... 30 seconds	Selecting the time period after which the device switches off display and backlighting when not in use and gross weight is 0. Display and backlighting are switched on again by pressing a key or if the weight changes.
<b>Power off</b>	Settings for switching off the device
Off	No energy saving mode
1 minute ... 30 minutes	Selecting the time period after which the device switches off when not in use and gross weight is 0. After this, it must be switched on again using  .

<b>Identification</b>	<b>Setting terminal identification data</b>
Terminal location	Entering the terminal location, e.g., floor and room
Terminal ID	Entering the terminal identification, e.g., inventory number
Notes	<ul style="list-style-type: none"> <li>Terminal location and terminal identification can be displayed in the auxiliary or info lines or printed out.</li> <li>Terminal location and terminal identification can consist of up to 12 characters (0 ... 9 and decimal point).</li> </ul>

<b>Display</b>	<b>Setting the display according to your specific task</b>
Display Layout	Selecting the presentation of the weight value.
Contrast (Operator access)	Setting the contrast of the display. This menu item is accessible with Operator access rights.
Brightness (Operator access)	Setting the brightness of the display. This menu item is accessible with Operator access rights.
Weight hold	Setting how long (in seconds) the weighing result is frozen in the display after the transfer key  has been pressed or auto print was generated.
Auxiliary line	Selecting the contents of the auxiliary display line.

<b>Keyboard</b>	<b>Setting the keyboard according to your specific task</b>
<b>Hard keys</b>	<b>Locking/unlocking keys</b> Possible keys: Power (  ), Clear ( <b>C</b> ), Switch / Toggle (  ), Info ( <b>i</b> ), Transfer (  ), Numeric keys ( <b>ICS435</b> and <b>ICS439</b> only)
<b>Info key</b>	<b>Configuring the items to be displayed using the info key ( <b>i</b> )</b>
Page 1	On the first page of the info key up to 9 information items on the weighing process can be configured. 1 Select item number. 2 Assign information
Page 2, Page 3	On pages 2 and 3 system and contact information will be displayed. In case of a problem, here you will find your contact data and the system information the service technician will ask for. System information is set by the manufacturer, contact information can be entered directly.
<b>Beeper</b>	<b>When set to On, each keystroke will be confirmed by a short beep.</b>

<b>Message time</b>	<b>Setting how long a message is displayed</b>
1, 2, 3, 4, 5, 6	Setting how long a message is displayed in seconds

<b>Battery</b>	<b>Battery settings</b>
<b>Charge strategy</b>	<b>Setting the charging strategy.</b>
Full	The battery will always be fully charged.
Preservation	Charging to prevent total discharge.

<b>Time out</b>	<b>Setting the behaviour when no action takes place on the terminal</b>
<b>Mode</b>	<b>Setting the time out mode.</b>
Off	No time out setting.
Rental	The scale can only be used until a set date, e.g., when the scale is rented for a special event like a fair or a market. After the expiration date a message is displayed: <b>Rental expired</b> and the scale can no longer be used.
Rental info	When the set date has passed, a message is displayed: <b>Rental expired</b> . By pressing the key <b>C</b> , the message is cleared and the scale can be used as before.
<b>Set date</b>	<b>Entering the expiration date.</b>
Set year	Entering the year of the expiration date.
Set month	Entering the month of the expiration date.
Set day	Entering the day of the expiration date.

### 3.5.3 Terminal → Access

<b>Supervisor</b>	<b>Password for Supervisor menu access</b>
Password	Enter password for Supervisor menu access.
Retype password	Repeat the password entry.
Note	The password can consist of up to 4 characters.

### 3.5.4 Terminal → Reset

<b>Reset</b>	<b>Resetting the terminal settings to factory settings</b>
Perform reset?	– Confirm resetting with <input type="checkbox"/> <sup>OK</sup> ✓.



## 3.6 Communication menu block

### 3.6.1 General



For detailed information on interface protocols and commands refer to the SICS Reference manual.

The `Communication` menu block consists of the following subblocks:

- **Overview** Showing the installed interfaces.
- **COM1** Parameter settings for the standard RS232 interface COM1.
- **COM2** Parameter settings for the optional second interface COM2.
- **Define templates** Defining templates to be assigned to the application-specific printouts.

The interfaces identify themselves. Therefore only those menu settings appear which are relevant for the individual interface. If no optional interface is installed, the COM2 menu will not appear.

### 3.6.2 Overview of the communication menu blocks

#### Possible settings

		COM1	COM2					
		RS232	RS232	RS422 / RS485	Ethernet	WLAN	USB Device	USB Host
Mode	Print	x	x	x	x	x	x	–
	Auto print							
	Instand print							
	Continuous (Dialog)*							
	Dialog*	Factory setting						
	External input	x	x	x	x	x	x	x
	Toledo cont.-weight Digitol B Digitol G	x	x	x	x	x	x	–
Second display	x	x	x	x	x	–	–	
Printer	x	x	x	x	x	x	–	
External input	x	x	x	x	x	x	x	
Parameter	Baud (factory setting)	9600	9600	9600	–	–	–	–
	Parity (factory setting)	8 none	8 none	8 none	–	–	–	–
	Handshake	x	x	x	–	–	–	–
	RS Type Net Address Load resistor	–	–	x	–	–	–	–
	DHCP IP address Subnet mask Gateway	–	–	–	x	x	–	–
	TCP settings	–	–	–	x	x	–	–
Wireless settings	–	–	–	–	x	–	–	

\* for more information see SICS Reference manual

\*\* only available for Toledo cont.-weight

## RS232 menu block

Level 1	Level 2	Level 3	Level 4
Mode	Print, Auto print, Instant print, <b>Dialog</b> , Continuous (Dialog), External input, Toledo Cont.-weight, Second display, SICS scale, X scale		
	Digitol B, Digitol G	Net Gross Tare	On, <b>Off</b>
Printer	Type	<b>ASCII printer</b> , Values only	
	ASCII Format	Line format	<b>Multiple</b> , Single, Fixed
		Line length	1 ... <b>24</b> ... 100
		Separator (for line format Single only)	, ; - _ / \ Space
		Add line feed	<b>0</b> ... 9
External input	Preamble length		
	Data length		
	Postamble length		
	Termination character	CR, LF, EOT, ...	
	Destination	Off, Tare preset, ID1, ID2, ID3	
Parameter	Baud	300, 600, ... <b>9600</b> , ... 115200 baud	
	Parity	7 none, <b>8 none</b> , 7 odd, 8 odd, 7 even, 8 even	
	Handshake	Off, Xon – Xoff	
	Checksum	Off, On	
Reset RS232	Perform Reset?		

## RS422 / RS485 menu block

Level 1	Level 2	Level 3
Mode	Print, Auto print, Instant print, <b>Dialog</b> , Continuous (Dialog), External input, Toledo Cont.-weight, Second display, SICS scale, X scale, SICSpro scale	
Printer	see RS232	
External input		
Parameter	Baud	300, 600, ... 9600, ... 115200 baud
	Parity	7 none, <b>8 none</b> , 7 odd, 8 odd, 7 even, 8 even
	Handshake	<b>Off</b> , Xon – Xoff
	RS-Type	<b>RS422</b> , RS485
	Net address	<b>0</b> ... 31
	Checksum	<b>Off</b> , On
	Load resistor	<b>Off</b> , On
Reset RS4xx	Perform Reset ?	

### Ethernet menu block

Level 1	Level 2	Level 3
Mode	see RS232	
Printer		
External input		
Parameter	DHCP	<b>Off, On</b>
	Local IP	
	Subnet mask	
	Gateway	
	Checksum	<b>Off, On</b>
TCP Mode	TCP Mode	<b>Server, Client, FreeWeigh</b>
	Local Port	<b>4305</b>
	Remote IP	
	Remote port	
	Connect timeout	
	Disconnect timeout	
Reset Ethernet	Perform Reset?	



### USB Host menu block

Level 1	Level 2	Level 3
USB version		
Keyboard / Barcode Reader	Preamble length	
	Data length	
	Postamble length	
	Termination char.	
	Destination	
USB settings	Alibi on the fly	On, Off

### USB Device menu block

Level 1	Level 2	Level 3	Level 4
Mode	Continuous (Dialog), <b>Dialog</b> , External input, Toledo Cont.-weight, Print, Auto print, Instant print		
	Digitol B, Digitol G	Net, Gross, Tare	On, <b>Off</b>
Reset USB	Perform Reset?		

### 3.6.3 Description of the communication menu blocks

Mode	Operating mode of the serial interface
<b>Print</b>	Manual data output of stable results to the printer with 
<b>Auto print</b>	Automatic output of stable results to the printer (e.g., for series weighing operations)
<b>Instant print</b>	Manual data output of the current weight value (either stable or not) to the printer with 
<b>Dialog</b>	Bi-directional communication via MT-SICS commands, control of the device via PC
<b>Continuous (Dialog)</b>	Ongoing output of all weight values via the interface
<b>External input</b>	Input other than via terminal keypad. What the input is used for is defined in the <code>Destination</code> menu block.
<b>Toledo Cont.-weight</b>	TOLEDO Continuous mode
<b>Second display</b>	On the selected interface port, a second display is connected.
<b>Digital scale</b>	On the selected interface port, a digital scale is connected.
<b>Digitol B</b> <b>Digitol G</b>	Digitol compatible format. The gross weight is identified by "B". Digitol compatible format. The gross weight is identified by "G".
Net, Gross, Tare	Selecting the weight values to be transferred.
Notes	Printing conditions for <code>Auto print</code> : <ul style="list-style-type: none"> <li>• The weight must be heavier than 9 display increments.</li> <li>• A weight change of at least 9 display increments is required to initiate the next printout.</li> </ul>

Printer	Configuring printer and formats for the protocol printout	
<b>Type</b>	ASCII printer	If <code>Values only</code> is selected, the transmitted data does not include the name of the variable, e.g., date, gross, ID1, but the value and, if appropriate, the unit, as a separate line. This allows the label printer to fill its template with the required data.
	Values only	
<b>ASCII format</b>	<b>Line format</b>	<b>Selecting line format</b> (for ASCII printers only)
	Multiple	Multiple lines
	Single	Single lines
	Fixed	Fixed (records output in single lines; every record includes the number of characters that was defined under <code>Line length</code> )
	<b>Line length</b>	<b>Setting line length</b> This item is only displayed for the line formats <code>Multiple</code> and <code>Fixed</code> .
	<b>Separator</b>	<b>Selecting the separator</b> This item is only displayed for the line format <code>Single</code> .
	<b>Add line feed</b>	<b>Adding line feeds</b>





External input	Configuring input via barcode reader
Preamble length	The barcode may contain additional data before the relevant data (preamble) and behind (postamble).
Data length	
Postamble length	– Enter the number of characters of preamble, (relevant) data and postamble.
Termination char.	Selecting the termination character which is used by the connected barcode scanner
Destination	Selecting the item to be entered via barcode scanner

<b>USB Host</b>	<b>Configuring the USB Host interface</b>
<b>USB version</b>	<b>Show the implemented USB version</b>
<b>Keyboard / Barcode reader</b>	<b>Configure the external input via keyboard or barcode</b>
Preamble length	The barcode may contain additional data before the relevant data (preamble) and behind (postamble). – Enter the number of characters of preamble, (relevant) data and postamble.
Data length	
Postamble length	
Termination char.	Selecting the termination character which is used by the connected barcode scanner
Destination	Selecting the item to be entered via barcode scanner
<b>USB settings</b>	<b>Configuring an external alibi memory</b>
Alibi on the fly	When set to <code>On</code> and a USB stick is inserted, the records are stored on the USB stick as well.

### Connecting an USB keyboard

- To connect an external keyboard via USB Host, the COM port has to be defined as `External input` with the termination character LF.
- If a function is assigned to the external input as well, e.g., "Load article", use the Enter key to confirm the external input.

The function keys of the USB keyboard correspond to the following keys on the weighing terminal:

F1		F8	Displayed soft key 4
F2		F9	Displayed soft key 5 (right)
F3		ESC	 in the menu
F4		Back	Delete text character by character
F5	Displayed soft key 1 (left)	Enter	In straight weighing: print As external input: confirm
F6	Displayed soft key 2	Cursor keys	Cursor keys
F7	Displayed soft key 3		

Parameter	Communication parameters
Baud	Selecting baud rate
Parity	Selecting parity
Handshake	Selecting handshake
Checksum	Activating/deactivating checksum byte
STX	Activating/deactivating STX If STX is set to <code>On</code> , the STX signal (0x02) is sent at the beginning of each output string that is sent via the interface.
RS Type	Selecting type of the optional RS422/RS485 interface: either RS422 or RS485
Net Address	Assigning network address
Load resistor	To avoid reflections on a network, we recommend to make a defined termination. For this purpose, the load resistor within the terminal can be used. When set to <code>On</code> , a resistor of approx. 100 Ohm between the signal lines is enabled.

<b>Parameter</b>	<b>Communication parameters</b>
DHCP	If DHCP is set to <code>on</code> , the device will receive the IP address automatically. Then IP address, Subnet mask and Gateway are read-only fields.
Local IP	Displaying/entering the local IP address
Subnet mask	Displaying/entering subnet mask
Gateway	Displaying/entering gateway address
Note	Not all parameters are available on all serial interfaces. Refer to the overviews of the interfaces to check which parameters are available.

<b>TCP Mode</b>	<b>Transmission control protocol settings</b>
<b>TCP Mode</b>	<b>Configuring TCP mode</b>
Server	Weighing terminal acting as server E.g., to execute SICS commands from a PC. To do so, the weighing terminal must be configured as Server and the PC must be configured as Client.
Client	Weighing terminal acting as client E.g., to print to a PC or printer. To do so, the weighing terminal must be configured as Client and the PC must be configured as Server.
FreeWeigh	To connect as SICS scale to freeweigh.net
<b>Local Port</b>	<b>Displaying/entering the local port</b>
<b>Remote IP</b>	<b>Displaying/entering the remote IP address</b>
<b>Remote Port</b>	<b>Displaying/entering the remote port</b>
<b>Connect timeout</b>	<b>Setting timeout for connecting</b>
<b>Disconnect timeout</b>	<b>Setting timeout for disconnecting</b>

### 3.6.4 Digital I/Os menu block

Level 1	Level 2	Level 3
Input	Input pin 1 ... Input pin 4	Off, Zero, Tare, Transfer, Switch, Clear, Info
Output	Ready, Stable, Tare, Zero, < Min weigh, >= Min weigh, Underload, Overload, <= Setpoint 1, > Setpoint 1, <= Setpoint 2, > Setpoint 2, Star	<b>Off</b> , Output pin 1 ... Output pin 4
Setpoints	Setpoint 1, Setpoint 2	
Output mode	Continuous, Stable	

#### Configuring inputs

- 1 Select an input pin.
- 2 Assign an input signal to the selected input pin.

#### Configuring outputs

- 1 Select an output signal.
- 2 Assign an output pin.

#### Configuring setpoints

- Enter values for the setpoints.

#### Setting output mode

Continuous	Digital outputs are updated continuously
Stable	Digital outputs are updated only when the weight is stable

### 3.6.5 Define templates menu block

Level 1	Level 2	Level 3
Template 1	Line 1	Not used, Header *, Date, Time, Gross, Net, Tare, High resolution, ID1, ID2, ID3, Terminal ID, Terminl loc., SNo.
...	...	
Template 5	Line 30	Terminal, SNo. Scale, Star line, New line, Form feed

\* The content of these items has to be entered via SICS command.

#### Configuring templates

- 1 Select a template.
- 2 Select a line.
- 3 Assign an item.



There are 5 more templates available (Template 6 ... Template 10). Please ask your **METTLER TOLEDO** service technician to configure these templates or create them by yourself using the DatabICS software ([www.mt.com/ind-databics](http://www.mt.com/ind-databics)), if desired.

## 3.7 Maintenance menu block

### 3.7.1 Overview

Level 1	Level 2	Level 3	Level 4
Scale test	Scale	Internal test	Perform test?
		External test	Perform test?
		Conf. ext. test	Test weight
			Weight name
	Auto print	On, <b>Off</b>	Tolerance
Keyboard test	Perform test?		
Display test	Perform test?		
Serial no.	Serial no. Scale		
	Serial no. Terminal terminal		
Print setup	Print menu settings		
Tool comm.	Port		
	Baudrate		
	Start		
Reset all	Perform reset?		

### 3.7.2 Description

<b>Scale test</b>	<b>Testing the selected scale</b>
<b>Internal test</b>	<b>Testing scales with an internal test weight</b>
Perform test?	<ul style="list-style-type: none"> <li>– Press <input type="checkbox"/> <b>OK</b> <input type="checkbox"/> to start the test.</li> <li>⇒ The deviation between test weight value and actually weighed value is displayed.</li> </ul>
<b>External test</b>	<b>Testing scales without an internal test weight</b>
Perform test?	<ol style="list-style-type: none"> <li>1 Press <input type="checkbox"/> <b>OK</b> <input type="checkbox"/> to start the test. ⇒ <b>Preload</b> is displayed.</li> <li>2 If applicable, load the preload, and press <input type="checkbox"/> <b>OK</b> <input type="checkbox"/>.</li> <li>⇒ The test weight is blinking.</li> <li>3 Load the requested test weight and press <input type="checkbox"/> <b>OK</b> <input type="checkbox"/>.</li> <li>⇒ The deviation between test weight value and actually weighed value is displayed.</li> </ol>
<b>Conf. ext. test</b>	<b>Configuring the external test weight</b>
Test weight	Setting the test weight value
Weight name	Entering the test weight name
Tolerance	Setting the test tolerance
<b>Auto print</b>	<b>Automatic printout</b> When set to <b>On</b> , a protocol is printed for each scale test.



<b>Keyboard test</b>	<b>Testing the keyboard</b>
Perform test?	<ol style="list-style-type: none"> <li>1 Press <input type="checkbox"/>OK to start the keyboard test.</li> <li>2 Press the keys in the displayed order. <ul style="list-style-type: none"> <li>⇒ If the key works, the device switches to the next key.</li> <li>⇒ The keyboard test is terminated by pressing <input type="checkbox"/>OK.</li> </ul> </li> </ol>

<b>Display test</b>	<b>Testing the display</b>
Perform test?	<ol style="list-style-type: none"> <li>1 Press <input type="checkbox"/>OK to start the display test. <ul style="list-style-type: none"> <li>⇒ A checkerboard pattern is displayed.</li> </ul> </li> <li>2 Press any key to invert the checkerboard pattern.</li> <li>3 Press any key again. <ul style="list-style-type: none"> <li>⇒ <b>Completed</b> is displayed.</li> </ul> </li> <li>4 Press <input type="checkbox"/>OK to leave the display test.</li> </ol>
Note	The display is working properly when all fields are displayed without missing pixels.

<b>Serial number</b>	<b>Displaying serial numbers</b>
SNo. Scale	Displaying the serial number of the connected weighing platform
SNo. Terminal	Displaying the serial number of the weighing terminal

<b>Print setup</b>	<b>Printout of a list of all menu settings</b>
Print menu settings	– Press <input type="checkbox"/> OK to start the printout.

<b>Tool communication</b>	<b>Testing the communication</b>
Port	Selecting the COM port to be tested
Baudrate	Setting the baudrate for testing
Start	Starting tool communication test

<b>Reset all</b>	<b>Reset all settings to factory setting</b>
Perform reset?	– Reset all settings to factory settings with <input type="checkbox"/> OK.

## 4 Event and error messages

### 4.1 Error conditions

Error	Cause	Remedy
Display dark	• Backlighting set too dark	– Set backlighting brighter.
	• No power supply	– Check power supply.
	• Unit switched off	– Switch on unit.
	• Power supply cable not plugged in	– Plug in power supply cable.
	• Brief fault	– Switch device off and on again.
Weight display unstable	• Unstable installation location	– Adjust vibration adapter.
	• Draft	– Avoid draft.
	• Unstable weighing sample	– Dynamic weighing.
	• Contact between weighing pan and/or weighing sample and surrounding	– Remedy contact.
	• Power supply fault	– Check power supply
Incorrect weight display	• Incorrect zeroing	– Unload scale, set to zero and repeat weighing operation.
	• Incorrect tare value	– Clear tare.
	• Contact between weighing pan and/or weighing sample and surroundings	– Remedy contact.
	• Weighing platform tilted	– Level weighing platform.
[ _ _ _ _ ]	• Load plate not on the scale	– Place load plate on the scale.
	• Weighing range not reached	– Set to zero.
[ _ _ _ _ ]	• Weighing range exceeded	– Unload scale. – Reduce preload.
— — — —	• Result not yet stable	– If necessary, adjust vibration adapter.
<b>Attention: Approval invalid</b> alternating with metrological data	• Approval was tampered with	– Call <b>METTLER TOLEDO</b> service technician.

## 4.2 Errors and warnings

### Error messages

Error messages contain the following information:

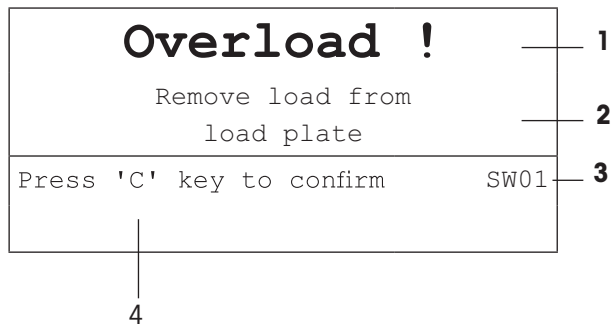

- 1 Error message
- 2 Remedy
- 3 Message identifier
- 4 How to clear the message

### Warnings

Warnings are displayed briefly and then disappear automatically.

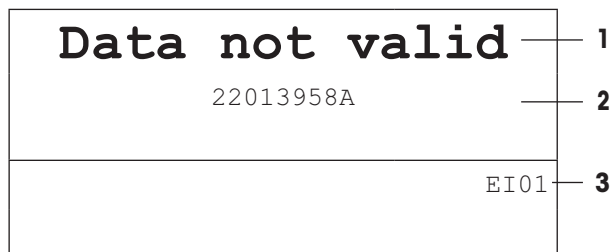

- 1 Warning
- 2 Additional information, e.g., which data is not valid
- 3 Warning identifier

### 4.3 Smart weighing counter / spanner icon

This weighing instrument features several control functions to monitor the condition of the device.

The **METTLER TOLEDO** service technician can setup and enable these functions.

This helps the user and the **METTLER TOLEDO** service technician to determine how the device is treated and what measures are needed to keep it in a good shape.

If the control functions triggers an alert, a message is shown.

You can confirm the message and continue to work with the weighing instrument. The spanner icon  lights up.

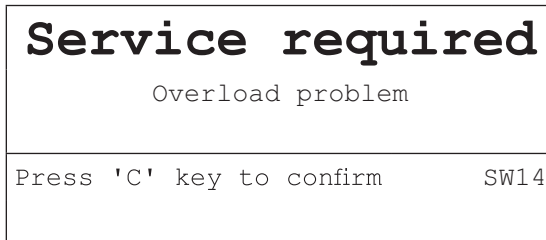

In case of an alert we strongly recommend calling the **METTLER TOLEDO** service technician

- to replace parts which are at the end of lifetime,
- to correct wrong settings,
- to educate operators about proper handling,
- to perform routine service work,
- to reset the alert.

The control functions monitor the following conditions:

- number of weighings
- number of overloads
- maximum weight
- zero commands and zero failures
- battery charging cycles
- power-on time
- date for the next service inspection

### 4.4 Service information



In case you need the **METTLER TOLEDO** service technician, you can read the necessary system and contact information from the device.

- 1 Press **i** twice.  
⇒ System information data are displayed.
- 2 Press **i** again  
⇒ Your contact data are displayed.

## 5 Technical data and accessories

### 5.1 Devices for dry environment

#### 5.1.1 Technical data for weighing terminals for dry environments

ICS4_5 weighing terminals		
Housing	Aluminium diecast	
Display	LCD liquid crystal graphical display, with back lighting	
Keyboard	Tactile-touch membrane keypad (PET) Scratch-resistant labelling	
Protection type	With power supply connection	IP65
	With built-in storage battery	IP65
	With exchangeable battery	IP5x
	Weighing platform	IP5x / IP65 (option, not for 0.6XS)
Net weight	Weighing terminal	2.0 kg / 4.4 lb
Power supply connection	Direct connection to power supply (supply voltage fluctuation not exceeding $\pm 10$ % of the rated voltage)	
	Rated voltage	100 ... 240 V AC / 50 ... 60 Hz / 300 mA
	Power cord	approx. 2.5 m / 8.2 ft
Battery operation	Supply of device	12 V  / 2.5 A
	Up to 22 hours of operation possible	
9-28 VDC power supply	Rated voltage	9 ... 28 V  / max. 2.5 A
	Power cord	approx. 5 m / 16 ft, open ends
Battery charger	Ambient conditions	0 ... 40 °C / 32 ... 104 °F, dry environment
Ambient conditions	Application	indoor use only
	Altitude	up to 2,000 m
	Temperature range Class III	-10 ... 40 °C / 14 ... 104 °F
	Temperature range Class II with PBK785	10 ... 30 °C / 50 ... 86 °F
	with PBK9-series / PFK9-series	0 ... 40 °C / 32 ... 104 °F
	Overvoltage category	II
	Pollution degree	2
Humidity	Max. rel. humidity 85 % for temperatures up to 40 °C / 104 °F	
W & M approvals	OIML Class II, III, IIII NTEP Class II, III	
Interfaces		
Communication interfaces	1 RS232 interface integrated 1 additional optional communication interface possible	
Scale interfaces	1 scale interface integrated	

## 5.1.2 Technical data for compact scales for dry environments



- The size of the weighing platform (0.6XS, 3XS, 6XS, 3SM, 6SM, 15LA, 35LA) is indicated at the end of the product name, e.g., **ICS425s-3XS/f**.
- Other combinations of weighing range and readability can be adjusted by the **METTLER TOLEDO** service technician on site.
- The table below indicates the factory settings of weighing range and readability.

### Weighing ranges and readability ICS4\_5s-.../f compact scales

- Approved resolution 1 x 6,000 e (OIML, NTEP)
- Non-approved resolutions up to 60,000 d

ICS4_5s-.../f	3SM	6SM	15LA	35LA
<b>Capacity</b>	3 kg	6 kg	15 kg	35 kg
	6 lb	12 lb	30 lb	60 lb
<b>Readability</b>				
Standard resolution: 6,000 d	0.5 g	1 g	2 g	5 g
	0.001 lb	0.002 lb	0.005 lb	0.01 lb
Optional resolution: 30,000 d	0.1 g	0.2 g	0.5 g	1 g
	0.0002 lb	0.0005 lb	0.001 lb	0.002 lb
Optional resolution: 60,000 d	0.05 g	0.1 g	0.2 g	0.5 g
	0.0001 lb	0.0002 lb	0.0005 lb	0.001 lb
Approved resolution: 6,000 e	0.5 g	1 g	2 g	5 g
	0.001 lb	0.002 lb	0.005 lb	0.01 lb
<b>Repeatability (sd)</b>	0.05 g	0.1 g	0.2 g	0.5 g
	0.0001 lb	0.0002 lb	0.0005 lb	0.001 lb
<b>Linearity</b>	0.1 g	0.2 g	0.5 g	1 g
	0.0002 lb	0.0005 lb	0.001 lb	0.002 lb
<b>Weight</b>	5.5 kg	5.5 kg	7.7 kg	7.7 kg
	12.1 lb	12.1 lb	17.0 lb	17.0 lb

### Weighing ranges and readability ICS4\_5k-.../f and ICS4\_5k-.../DR/f compact scales

- Approved resolution up to 61,000 e (OIML, NTEP)
- Non-approved resolutions up to 610,000 d
- FACT function (Fully Automatic Calibration Technology) calibrates the scale according to temperature changes thus increasing weighing accuracy

ICS4_5k-.../f	0.6XS	3XS	6XS	6SM	15LA	35LA
<b>Capacity</b>	0.61 kg	3.1 kg	6.1 kg	6.1 kg	15.1 kg	35.1 kg
	1.2 lb	6 lb	12 lb	12 lb	30 lb	60 lb
<b>Readability</b>						
Standard resolution	0.001 g	0.01 g	0.01 g	0.1 g	0.1 g	0.1 g
	0.000002 lb	0.00002 lb	0.00002 lb	0.0002 lb	0.0002 lb	0.0002 lb
Approved resolution	0.01 g	0.1 g	0.1 g	1 g	1 g	1 g
	0.00002 lb	0.0002 lb	0.0002 lb	0.002 lb	0.002 lb	0.002 lb
<b>Repeatability (sd)</b>	0.001 g	0.01 g	0.01 g	0.1 g	0.1 g	0.1 g
	0.000002 lb	0.00002 lb	0.00002 lb	0.0002 lb	0.0002 lb	0.0002 lb
<b>Linearity</b>	0.002 g	0.02 g	0.02 g	0.2 g	0.2 g	0.2 g
	0.000005 lb	0.00005 lb	0.00005 lb	0.0005 lb	0.0005 lb	0.0005 lb
<b>Weight</b>	6.3 kg	5.7 kg	5.7 kg	5.7 kg	9.0 kg	9.0 kg
	13.4 lb	12.6 lb	12.6 lb	12.6 lb	19.8 lb	19.8 lb

ICS4_5k-.../DR/f	0.6XS	3XS	6XS	6SM	15LA	35LA
<b>Capacity</b>	0.12 kg / 0.61 kg	0.6 kg / 3.1 kg	1.2 kg / 6.1 kg	1.2 kg / 6.1 kg	3 kg / 15.1 kg	3 kg / 15.1 kg
<b>Readability</b>						
Standard resolution	0.001 g / 0.01 g	0.01 g / 0.1 g	0.01 g / 0.1 g	0.1 g / 1g	0.1 g / 1g	0.1 g / 1g
Approved resolution	0.01 g	0.1 g	0.1 g	1 g	1 g	1 g

### Max. mechanical preload without losing capacity

ICS4_5	3SM	6SM	15LA	35LA
<b>Preload</b>	1.25 kg	3.25 kg	3.32 kg	13.32 kg
	2.76 lb	7.17 lb	7.32 lb	29.37 lb

ICS4_5	0.6XS	3XS	6XS	6SM	15LA	35LA
<b>Preload</b>	–	1.73 kg	0.73 kg	2.25 kg	20.32 kg	0.32 kg
	–	3.81 lb	1.61 lb	4.96 lb	44.80 lb	0.71 lb

### 5.1.3 Operating life with battery

The operating life during battery operation varies depending on the intensity of use, the configuration and the connected scale.

The following approximate values apply with standard RS232 interface and the brightness set to 5.

Weighing platform	Weighing terminal type	Conditions	Duration
Strain gauge weighing platform	<b>ICS4_5g</b>	WLAN, continuous operation	16 h
		USB host, continuous operation	16 h
MonoBloc® weighing platform	<b>ICS4_5k</b>	WLAN, continuous operation	10 h
		USB host, continuous operation	10 h

### 5.1.4 Dimensional drawings for devices for dry environments

#### ICS4\_5 weighing terminal

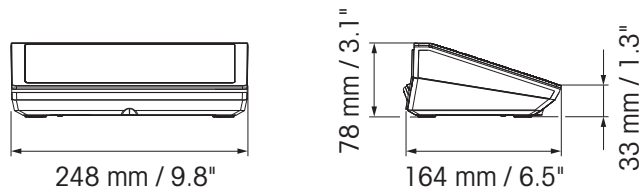

#### ICS4\_5 compact scale with XS or SM weighing platform

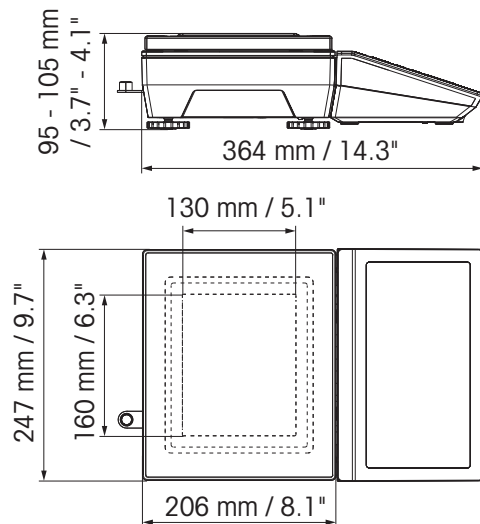



**ICS4\_5 compact scale with XS weighing platform and windshield**

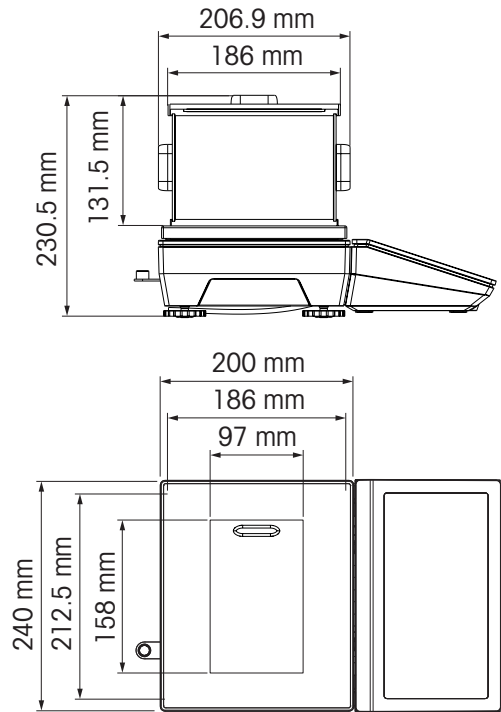

**ICS4\_5 compact scale with LA weighing platform**

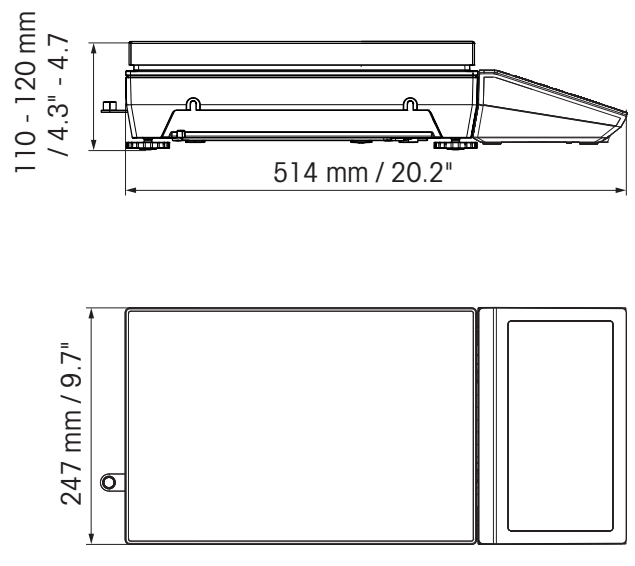
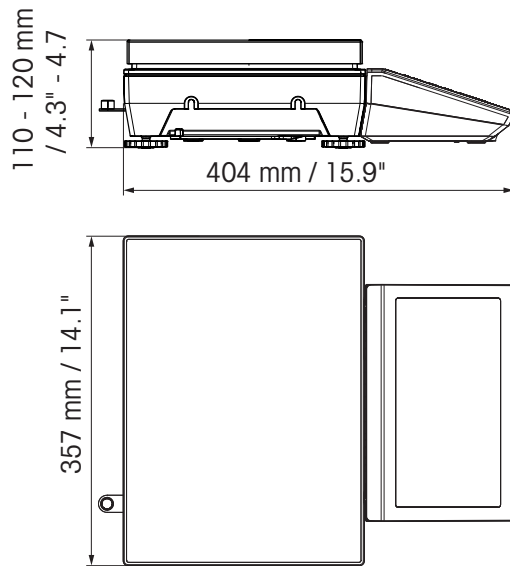

### 5.1.5 Accessories for dry environments



Accessories for ICS4_5	Order no.
Printer RS-P25/01 (for Europe only)	11 124 300
Printer RS-P26/01 (for Europe only)	11 124 304
Printer RS-P28/01 (for Europe only)	11 124 301
Printer APR510 Direct thermal Label Printer, 203 dpi	64 090 256
Printer APR510 Thermal Transfer Label Printer, 203 dpi	64 090 257
Printer APR510 Direct thermal Label Printer, 300 dpi	64 090 258
Printer APR510 Thermal Transfer Label Printer, 300 dpi	64 090 259
Printer APR710 Direct thermal Label Printer, 203 dpi	64 688 858
Printer APR710 Thermal Transfer Label Printer, 203 dpi	64 688 859
Printer APR710 Direct thermal Label Printer, 300 dpi	64 688 861
Protective cover for the weighing terminal, set of 5 pieces	30 032 638
Auxiliary display AD-RS-M7 (requiring cable 22 023 506)	12 122 381
Charging station for Battery pack (lithium ion)	30 093 236
Battery pack, lithium ion	
IP5x	30 093 237
IP65	30 093 238
Windshield for ...XS weighing platforms	72 262 929
Wall bracket	30 032 637
Support for wheeled bench stand	22 023 460
Column for PBA655, PBD655 and ICS4_5 / ICS685 compact scales (requires wall bracket 30 032 637)	
Height 330 mm / 1.3 ft	72 198 699
Height 660 mm / 2.6 ft	72 198 700
Floor stand, height 1000 mm / 3.3 ft	
Painted steel	22 023 451
Stainless steel	22 023 503
Relaybox 4, for Digital I/O	22 011 967
Power supply for Relaybox 4	00 505 544

<b>Cables and plugs for ICS4_5</b>	<b>Order no.</b>
<b>Cables</b>	
Cable M12 USB Female Type A, USB Host	
0.2 m / 0.7 ft	22 017 604
3 m / 10 ft	22 017 608
Cable M12 USB Male Type A, USB device, 3 m / 10 ft	22 018 967
Cable M12 RS232 Female Sub D 9 pin (crossed; used for PC)	22 017 601
Cable M12 RS232 Male Sub D 9 pin (not crossed; used for SICS scale)	22 017 602
Cable M12 RS422/485, open ends	22 017 603
Cable M12 Digital I/O, open ends	22 018 969
Cable M12 Ethernet RJ45	
5 m / 16 ft	22 017 610
20 m / 66 ft	22 017 614
Cable for auxiliary display AD-RS-M7	22 023 506
RS232 extension 0.5 m / 1.6 ft, incl. 5 V and 12 V	30 035 358
RS232 SICS (cross, M12 plug male / M12 male) 3 m	22 023 528
RS422/485 extension kit	22 023 698
SICSpro extension (M12 male / M12 female) *	
3 m / 10 ft	22 023 696
10 m / 32 ft	30 024 759
SICSpro extension (M12 male / open end) 5 m / 16 ft *	30 024 768
Cable for GA46	
0.4 m / 1.4 ft	22 018 978
2.5 m / 8 ft	22 018 979
<b>Plugs</b>	
RS232 Counter plug (8 pin; for compact scales, extension 30 035 358 required)	22 022 056
Ethernet Counter plug (4 pin, D; not for compact scales)	22 022 058
USB Device Counter plug (4 pin, A; not for compact scales)	22 022 059

\* Maximum admissible extension length: 30 m / 100 ft

## 5.2 Devices for wet environment

### 5.2.1 Technical data for weighing terminals for wet environments

ICS4_9 weighing terminals		
Housing	Stainless steel 1.4301 or AISI 304	
Display	LCD liquid crystal graphical display, with back lighting	
Keyboard	Tactile-touch membrane keypad (PET) Scratch-resistant labelling	
Protection type	Terminal	IP68/IP69k
	Standard weighing platform	IP65
	Weighing platform with option potted stainless steel load cell	IP65/IP67
	Weighing platform with option hermetically sealed stainless steel load cell	IP68/IP69k
Net weight	Weighing terminal	2.0 kg / 4.4 lb
	<b>ICS4_9g.../c</b>	3.2 kg / 7.1 lb + weight of the weighing platform
Power supply connection	Direct connection to power supply (supply voltage fluctuation not exceeding $\pm 10$ % of the rated voltage)	
	Rated voltage	100 ... 240 V AC 50 ... 60 Hz 300 mA
Battery operation	Supply of device	12 V  / 2.5 A
	Up to 22 hours of operation possible	
9-28 VDC power supply	Rated voltage	9 ... 28 V  / max. 2.5 A
	Power cord	approx. 5 m / 16 ft, open ends
Battery charger	Ambient conditions	0 ... 40 °C / 32 ... 104 °F dry environment
Ambient conditions	Application	indoor use only
	Altitude	up to 2,000 m
	Temperature range Class III	-10 ... 40 °C / 14 ... 104 °F
	Temperature range Class II	0 ... 40 °C / 32 ... 104 °F
	Overvoltage category	II
	Pollution degree	2
	Humidity	Max. rel. humidity 85 % for temperatures up to 40 °C / 104 °F
W & M approvals	OIML Class II, III, IIII NTEP Class II, III	
Interfaces		
Communication interfaces	1 RS232 interface integrated 1 additional optional communication interface possible	
Scale interfaces	1 scale interface integrated	

## 5.2.2 Technical data for terminal and platform combinations for wet environments



- The size of the weighing platform (A, BB, B, QA, QB) is indicated at the end of the product name, e.g., **ICS429g-QA6**.
- Other combinations of weighing range and readability can be adjusted by the **METTLER TOLEDO** service technician on site.
- The table below indicates the factory settings of weighing range and readability.

### Weighing ranges and readability

Model	A3	A6	A15	BB30	BB60	B30	B60
Weighing range	3 kg	6 kg	15 kg	30 kg	60 kg	30 kg	60 kg
	5 lb	10 lb	25 lb	50 lb	100 lb	50 lb	100 lb
Readability	1 g	2 g	5 g	10 g	20 g	10 g	20 g
	0.001 lb	0.002 lb	0.005 lb	0.01 lb	0.02 lb	0.01 lb	0.02 lb

Model	QA3	QA6	QB15	QB30	QB60
Weighing range	3 kg	6 kg	15 kg	30 kg	60 kg
	5 lb	10 lb	25 lb	50 lb	100 lb
Readability	1 g	2 g	5 g	10 g	20 g
	0.001 lb	0.002 lb	0.005 lb	0.01 lb	0.02 lb

### Operation limits – maximum static safe load

Model	a – center load	b – side load	c – corner load	
<b>A</b>	40 kg	30 kg	15 kg	
	80 lb	60 lb	30 lb	
<b>BB</b>	100 kg	70 kg	35 kg	
	200 lb	140 lb	70 lb	
<b>B</b>	200 kg	140 kg	75 kg	
	400 lb	280 lb	150 lb	
<b>QA</b>	40 kg	30 kg	15 kg	
	80 lb	60 lb	30 lb	
<b>QB</b>	100 kg	70 kg	35 kg	
	200 lb	140 lb	70 lb	

### Weights, approximate values

Model	Standard: potted aluminium	Option: potted stainless steel	Option: hermetically sealed stainless steel
<b>A</b>	4.8 kg	5.5 kg	5.7 kg
	10.6 lb	12.1 lb	12.6 lb
<b>BB</b>	7.2 kg	7.9 kg	8.1 kg
	15.9 lb	17.4 lb	17.9 lb
<b>B</b>	12.0 kg	15.0 kg	15.2 kg
	16.5 lb	33.1 lb	33.5 lb
<b>QA</b>	3.7 kg	4.4 kg	4.6 kg
	8.2 lb	9.7 lb	10.1 lb
<b>QB</b>	6.0 kg	6.7 kg	6.9 kg
	13.2 lb	14.8 lb	15.2 lb

### Length of load cell cable for ICS4\_9g-.../t

Models	Potted aluminum load cell	Potted stainless steel load cell Hermetically sealed stainless steel load cell
<b>A, QA</b>	1 m / 3.3 ft	3 m / 9.9 ft
<b>BB, B, QB</b>	2 m / 6.6 ft	

### 5.2.3 Operating life with battery

The operating life during battery operation varies depending on the intensity of use, the configuration and the connected scale.

The following approximate values apply with standard RS232 interface and the brightness set to 5.

Weighing platform	Conditions	Duration
With 1 strain gauge load cell, e.g., <b>ICS429g-A15...</b>	Continuous operation	25 h
With 4 strain gauge load cells, e.g., a floor scale	Continuous operation	22 h
With PBK98_/PFK98_	Continuous operation	14 h

## 5.2.4 Dimensional drawings for devices for wet environments

### ICS4\_9 weighing terminal

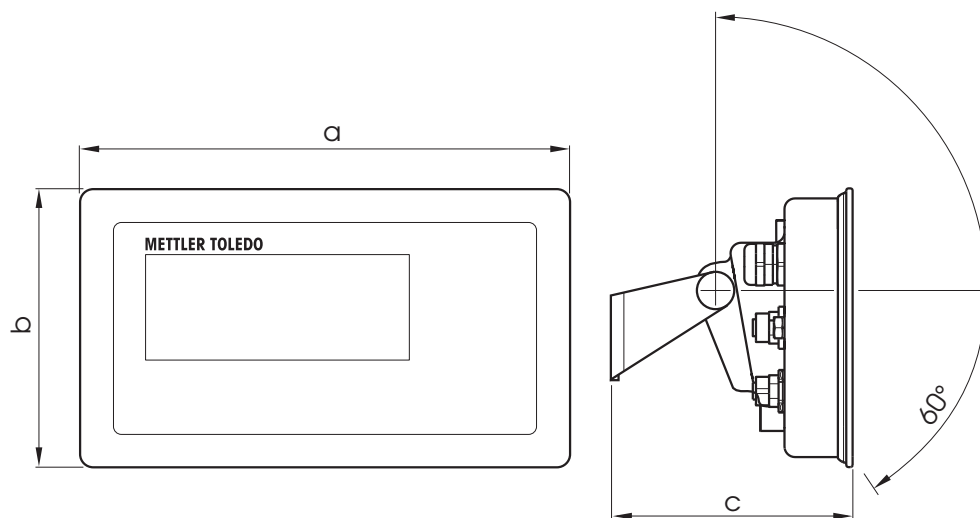

Dimension	[mm]	["]
<b>a</b>	232	9.13
<b>b</b>	132	5.20
<b>c</b>	115	4.53

### Weighing platforms for ICS4\_9g terminal and platform combinations

Front view

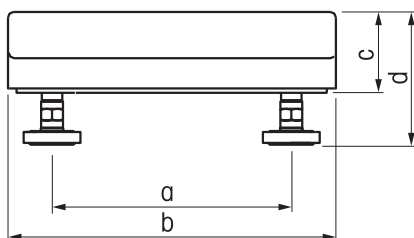

Side view

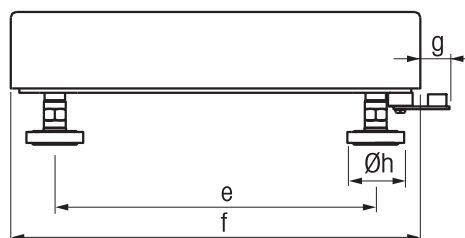

Dim.	A		B		BB		QA		QB	
	[mm]	["]	[mm]	["]	[mm]	["]	[mm]	["]	[mm]	["]
<b>a</b>	175	6.89	235	9.25	335	13.81	163	6.41	240	9.45
<b>b</b>	240	9.45	300	11.81	400	15.74	228	8.97	305	12.00
<b>c</b>	59	2.32	76	2.99	108.5	4.27	59	2.32	76	2.99
<b>d</b>	97	3.81	108	4.25	134,5	5.29	97	3.81	108	4.25
<b>e</b>	235	9.25	335	13.81	435	17.12	163	6.41	254	10.0
<b>f</b>	300	11.81	400	15.74	500	19.68	228	8.97	305	12.00
<b>g</b>	21	0.83	18	0.70	17	0.70	21	0.83	17	0.67
<b>h</b>	42	1.65	42	1.65	42	1.65	42	1.65	42	1.65

### ICS4\_9g-.../f terminal and platform combination

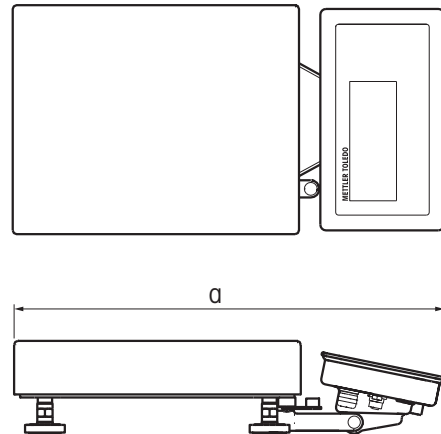

	A		B		BB		QA		QB	
Dim.	[mm]	["]	[mm]	["]	[mm]	["]	[mm]	["]	[mm]	["]
<b>a</b>	452	17.80	549	21.61	649	25.55	380	14.96	452	17.80

### ICS4\_9g-.../c terminal and platform combination

The size of the weighing platform (A, BB, B, QA, QB) is indicated at the end of the product name, e.g., **ICS429a-QA6**.

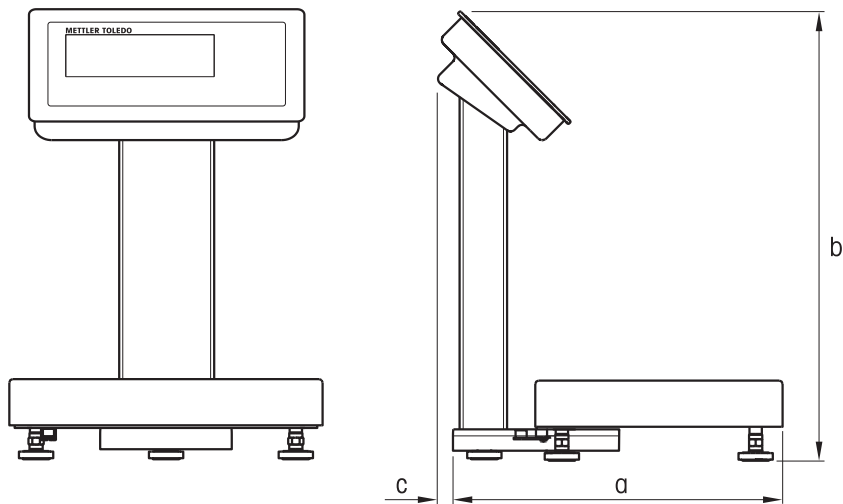

	A		B		BB		QA		QB	
Dim.	[mm]	["]	[mm]	["]	[mm]	["]	[mm]	["]	[mm]	["]
<b>a</b>	452	17.80	549	21.61	649	25.55	380	14.96	452	17.80
<b>b</b>	386	15.20	386	15.20	386	15.20	386	15.20	386	15.20
<b>c</b>	13	0.51	13	0.51	13	0.51	13	0.51	13	0.51



## 5.2.5 Accessories for wet environments

<b>Accessories for ICS4_9</b>	<b>Order no.</b>
GA46 printer, RS232, incl. 8-pin M12 plug cable 2.5 m / 8.2 ft cable 0.4 m / 1.3 ft	22 019 925 22 019 926
<b>I/O accessories</b>	
Relaybox 4, for Digital I/O	22 011 967
Power supply for Relaybox 4	00 505 544
<b>Mechanical parts</b>	
Protective cover for terminals <b>ICS4_9</b> , set of 3 pieces	22 021 109
Stand <b>ICS4_9</b> , for .../f version or terminal with PBA226, PBA426, PBA429 Height 120 mm / 0.4 ft Height 330 mm / 1.1 ft Height 660 mm / 2.2 ft Height 900 mm / 3.0 ft	72 219 393 72 198 702 72 198 703 72 198 704
Stand <b>ICS4_9</b> for PBK, PFK, MA, MD and DB Platforms, height 330 mm / 1.1 ft	22 014 836
Bench stand <b>ICS4_9</b> for scale bench 00 503 632 or 00 504 854, height 500 mm / 1.6 ft	22 014 835
Floor stand <b>ICS4_9</b> , height 1000 mm / 3.3 ft	22 014 834
Standbase for floor stand	22 011 982
Wall bracket <b>ICS4_9</b> , inclinable and swivelling	22 014 833
Desk mounting plate, for terminal and .../f version only	22 021 111

<b>Cables and plugs for ICS4_9</b>	<b>Order no.</b>
<b>Cables</b>	
RS232 cable for SICS scale, 8 pin M12 <-> 9 pin sub D plug, 3 m / 10 ft	22 021 087
RS232 cable for PC, 8 pin M12 <-> 9 pin sub D receptacle, 3 m / 10 ft	22 021 088
RS422/RS485 cable, 6 pin M12 <-> open ends, 3 m / 10 ft	22 021 089
Ethernet cable, 4 pin M12 coding D <-> RJ45 5 m / 16.4 ft 20 m / 65.6 ft	22 021 090 22 021 091
Cable to connect Digital I/O option with relay box, 12 pin M12 <-> open ends, 10 m / 32.8 ft	22 021 093
USB Device cable, connection to PC, 3 m / 10 ft	22 021 092
USB Host cable, connection to scanner, keyboard or USB stick, M12 USB female type A 0.2 m / 0.7 ft 3 m / 10 ft	30 093 252 30 093 253
<b>Plugs</b>	
RS232 counter plug, 8 pin M12 (for .../f versions extension 30 035 358 required)	22 022 056
Ethernet counter plug, 4 pin, coding D, M12 (not for .../f versions)	22 022 058
USB Device counter plug, 4 pin, coding A, M12 (not for .../f versions)	22 022 059
RS422/485 extension kit	22 023 698

## 5.3 General technical data

### 5.3.1 Applications

- Weighing
- Average weighing

### 5.3.2 Analog scale interface

Impedance	≥ 87.5 Ohm, e.g., 1 x 350 Ohm or 4 x 350 Ohm
Excitation	3.3 V DC
Sensitivity	2 to 3 mV/V
Max. resolution	7,500 e (OIML) 300,000 d (non approvable)
Min. verification interval	0.264 µV/e

### 5.3.3 Assignment of the interface connections

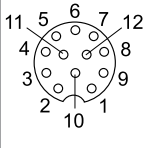
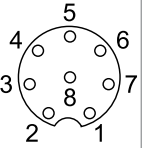
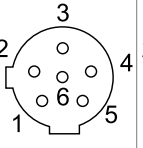
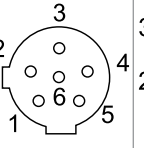
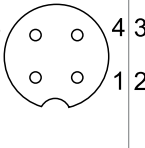
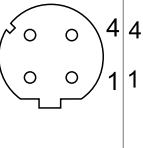
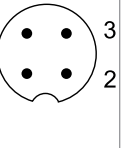
	Digital I/O	RS232	RS422	RS485	USB Device USB Host	Ethernet	Power
<b>Socket</b>							
<b>Pin 1</b>	In 0	CTS	TxD	T/RxD	+5 V *	TD+	+12 V *
<b>Pin 2</b>	In 1	TxD	TxD-	T/RxD-	D-	RD+	+12 V *
<b>Pin 3</b>	In 2	RTS	RxD	-	GND	TD-	GND
<b>Pin 4</b>	In 3	RxD	+12 V *	+12 V *	D+	RD-	GND
<b>Pin 5</b>	In_GND	+12 V *	GND	GND			
<b>Pin 6</b>	Out 0	+5 V *	RxD-	-			
<b>Pin 7</b>	Out 1	-					
<b>Pin 8</b>	Out 2	GND					
<b>Pin 9</b>	Out 3						
<b>Pin 10</b>	Out_GND						
<b>Pin 11</b>	+12 V *						
<b>Pin 12</b>	GND						

\* max. 0.5 A

## 6 Appendix

### 6.1 Metrological information

Scales that have been factory-calibrated have a label indicating this on the packaging.

Scales with a green M on the type plate are ready for operation.



Scales that are calibrated in two stages have a label indicating this on the packaging.

These scales have only been calibrated in a first stage (declaration of conformity in accordance with EN 45501-8.2). The second stage of the calibration must be done on-site by authorized service personnel. Please contact your local representative.



Medium accuracy scales that are used in commerce where certified calibration is required must be calibrated and certified.

Observe the respective measurement data guidelines in your country.

### 6.2 Table of Geo Code values

The Geo code feature provided in the weighing terminal permits calibration readjustment by a METTLER TOLEDO service technician due to changes in elevation or latitude without reapplying test weights. This adjustment assumes that a previously accurate calibration was done with the Geo code set properly for that original location and that the Geo code for the new location can be accurately determined.

When a weighing terminal is to be reinstalled at a different geographic location, gravitational and altitude changes can be accounted for by the following steps.

Note that this procedure is not necessary if an on-site recalibration is performed.

#### Determining the Geo code value

There are two methods to determine the Geo code value for your location.

##### Method A

- 1 Go to <https://www.welmec.org/welmec/gravity-information/> and obtain the g value (e.g. 9.770390 m/s<sup>2</sup>) for your specific geographic location.
- 2 Check the METTLER TOLEDO Geo code Table A to select the Geo code according to your g value, e.g. Geo code 20 should be applied if your g value is 9.810304.

##### Method B

- Use the METTLER TOLEDO Geo code Table B to determine the Geo code for the new altitude and location where the scale will be used.  
The latitude and height above sea level can be found using this link <https://www.mapcoordinates.net/en>.

#### Checking the Geo code value in the instrument

- Switch the weighing terminal off and on again.  
⇒ The currently set Geo code value is displayed when starting up.

#### Comparing Geo codes

- 1 Compare the determined Geo code with the current Geo code setting of the weighing terminal.
- 2 If the two Geo code values do not match, call the METTLER TOLEDO service technician.  
When the system is certified, a re-verification will be necessary.

#### Note

Using the Geo code value for calibration adjustment is not as accurate as re-applying certified test weights and re-calibrating the scale in a new location.

**Table A: Definition of METTLER TOLEDO Geo codes with g value**

Geo code	g value (m/s <sup>2</sup> )	Geo code	g value (m/s <sup>2</sup> )	Geo code	g value (m/s <sup>2</sup> )	Geo code	g value (m/s <sup>2</sup> )
0	9.770390	8	9.786316	16	9.802295	24	9.818326
1	9.772378	9	9.788311	17	9.804296	25	9.820333
2	9.774367	10	9.790306	18	9.806298	26	9.822341
3	9.776356	11	9.792302	19	9.808300	27	9.824351
4	9.778347	12	9.794299	20	9.810304	28	9.826361
5	9.780338	13	9.796297	21	9.812308	29	9.828371
6	0.782330	14	9.798295	22	9.814313	30	9.830383
7	9.784323	15	9.800295	23	9.816319	31	9.832396

**Table B: Definition of METTLER TOLEDO Geo codes with geographic latitude and height**

Geographical latitude, North or South	Height above sea level											
	[m]	0 - 325	325 - 650	650 - 975	975 - 1300	1300 - 1625	1625 - 1950	1950 - 2275	2275 - 2600	2600 - 2925	2925 - 3250	3250 - 3575
	[ft]	0 - 1060	1060 - 2130	2130 - 3200	3200 - 4260	4260 - 5330	5330 - 6400	6400 - 7460	7460 - 8530	8530 - 9600	9600 - 10660	10660 - 11730
0° 0' - 5° 46' (0.0° - 5.77°)		5	4	4	3	3	2	2	1	1	0	0
5° 46' - 9° 52' (5.77° - 12.87°)		5	5	4	4	3	3	2	2	1	1	0
9° 52' - 12° 44' (12.87° - 12.73°)		6	5	5	4	4	3	3	2	2	1	1
12° 44' - 15° 6' (12.73° - 15.1°)		6	6	5	5	4	4	3	3	2	2	1
15° 6' - 17° 10' (15.1° - 17.17°)		7	6	6	5	5	4	4	3	3	2	2
17° 10' - 19° 2' (17.17° - 19.03°)		7	7	6	6	5	5	4	4	3	3	2
19° 2' - 20° 45' (19.03° - 20.75°)		8	7	7	6	6	5	5	4	4	3	3
20° 45' - 22° 22' (20.75° - 22.37°)		8	8	7	7	6	6	5	5	4	4	3
22° 22' - 23° 54' (22.37° - 23.9°)		9	8	8	7	7	6	6	5	5	4	4
23° 54' - 25° 21' (23.9° - 25.35°)		9	9	8	8	7	7	6	6	5	5	4
25° 21' - 26° 45' (23.35° - 26.75°)		10	9	9	8	8	7	7	6	6	5	5
26° 45' - 28° 6' (26.75° - 28.1°)		10	10	9	9	8	8	7	7	6	6	5
28° 6' - 29° 25' (28.1° - 29.42°)		11	10	10	9	9	8	8	7	7	6	6
29° 25' - 30° 41' (29.42° - 30.68°)		11	11	10	10	9	9	8	8	7	7	6
30° 41' - 31° 56' (30.68° - 31.93°)		12	11	11	10	10	9	9	8	8	7	7
31° 56' - 33° 9' (31.93° - 33.15°)		12	12	11	11	10	10	9	9	8	8	7
33° 9' - 34° 21' (33.15° - 34.35°)		13	12	12	11	11	10	10	9	9	8	8
34° 21' - 35° 31' (34.35° - 35.52°)		13	13	12	12	11	11	10	10	9	9	8
35° 31' - 36° 41' (35.52° - 36.68°)		14	13	13	12	12	11	11	10	10	9	9

Geographical latitude, North or South	Height above sea level											
	[m]	0 - 325	325 - 650	650 - 975	975 - 1300	1300 - 1625	1625 - 1950	1950 - 2275	2275 - 2600	2600 - 2925	2925 - 3250	3250 - 3575
	[ft]	0 - 1060	1060 - 2130	2130 - 3200	3200 - 4260	4260 - 5330	5330 - 6400	6400 - 7460	7460 - 8530	8530 - 9600	9600 - 10660	10660 - 11730
36° 41' - 37° 50' (36.68° - 37.83°)		14	14	13	13	12	12	11	11	10	10	9
37° 50' - 38° 58' (37.83° - 38.97°)		15	14	14	13	13	12	12	11	11	10	10
38° 58' - 40° 5' (38.97° - 40.08°)		15	15	14	14	13	13	12	12	11	11	10
40° 5' - 41° 12' (40.08° - 41.2°)		16	15	15	14	14	13	13	12	12	11	11
41° 12' - 42° 19' (41.2° - 42.32°)		16	16	15	15	14	14	13	13	12	12	11
42° 19' - 43° 26' (42.32° - 43.43°)		17	16	16	15	15	14	14	13	13	12	12
43° 26' - 44° 32' (43.43° - 44.53°)		17	17	16	16	15	15	14	14	13	13	12
44° 32' - 45° 38' (44.53° - 45.63°)		18	17	17	16	16	15	15	14	14	13	13
45° 38' - 46° 45' (45.63° - 46.75°)		18	18	17	17	16	16	15	15	14	14	13
46° 45' - 47° 51' (46.75° - 47.85°)		19	18	18	17	17	16	16	15	15	14	14
47° 51' - 48° 58' (47.85° - 48.97°)		19	19	18	18	17	17	16	16	15	15	14
48° 58' - 50° 6' (48.97° - 50.1°)		20	19	19	18	18	17	17	16	16	15	15
50° 6' - 51° 13' (50.1° - 51.22°)		20	20	19	19	18	18	17	17	16	16	15
51° 13' - 52° 22' (51.22° - 52.37°)		21	20	20	19	19	18	18	17	17	16	16
52° 22' - 53° 31' (52.37° - 53.52°)		21	21	20	20	19	19	18	18	17	17	16
53° 31' - 54° 41' (53.52° - 54.68°)		22	21	21	20	20	19	19	18	18	17	17
54° 41' - 55° 52' (54.68° - 55.87°)		22	22	21	21	20	20	19	19	18	18	17
55° 52' - 57° 4' (55.87° - 57.07°)		23	22	22	21	21	20	20	19	19	18	18
57° 4' - 56° 17' (57.07° - 56.28°)		23	23	22	22	21	21	20	20	19	19	18
56° 17' - 59° 32' (56.28° - 59.53°)		24	23	23	22	22	21	21	20	20	19	19
59° 32' - 60° 49' (59.53° - 60.82°)		24	24	23	23	22	22	21	21	20	20	19
60° 49' - 62° 9' (60.82° - 62.15°)		25	24	24	23	23	22	22	21	21	20	20
62° 9' - 63° 30' (62.15° - 63.5°)		25	25	24	24	23	23	22	22	21	21	20
63° 30' - 64° 55' (63.5° - 64.92°)		26	25	25	24	24	23	23	22	22	21	21
64° 55' - 66° 24' (64.92° - 66.4°)		26	26	25	25	24	24	23	23	22	22	21
66° 24' - 67° 57' (66.4° - 67.95°)		27	26	26	25	25	24	24	23	23	22	22
67° 57' - 69° 35' (67.95° - 69.58°)		27	27	26	26	25	25	24	24	23	23	22
69° 35' - 71° 21' (69.58° - 71.35°)		28	27	27	26	26	25	25	24	24	23	23

Geographical latitude, North or South	Height above sea level											
	[m]	0 - 325	325 - 650	650 - 975	975 - 1300	1300 - 1625	1625 - 1950	1950 - 2275	2275 - 2600	2600 - 2925	2925 - 3250	3250 - 3575
	[ft]	0 - 1060	1060 - 2130	2130 - 3200	3200 - 4260	4260 - 5330	5330 - 6400	6400 - 7460	7460 - 8530	8530 - 9600	9600 - 10660	10660 - 11730
71° 21' - 73° 16' (71.35° - 73.27°)		28	28	27	27	26	26	25	25	24	24	23
73° 16' - 75° 24' (73.27° - 75.4°)		29	28	28	27	27	26	26	25	25	24	24
75° 24' - 77° 52' (75.4° - 77.87°)		29	29	28	28	27	27	26	26	25	25	24
77° 52' - 80° 56' (77.87° - 80.93°)		30	29	29	28	28	27	27	26	26	25	25
80° 56' - 85° 45' (80.93° - 85.75°)		30	30	29	29	28	28	27	27	26	26	25
85° 45' - 90° 0' (85.75° - 90.0°)		31	30	30	29	29	28	28	27	27	26	26

### 6.3 Disposal

In accordance with the requirements of European Directive 2002/96 EC on Waste Electrical and Electronic Equipment (WEEE), this device may not be disposed of with domestic refuse. This also applies for countries outside the EU in accordance with their respective national regulations.



- Please dispose of this product in accordance with local regulations for the separate collection of waste electrical and electronic equipment.

Should you have any questions, please contact the corresponding authorities or the dealer from whom this device was purchased.

If this device is passed on (for example for further private or commercial/industrial use), this regulation is also to be passed on.

Many thanks for your contribution to the protection of the environment.

#### Battery disposal

Batteries contain heavy metals and therefore cannot be disposed of in the normal refuse.

- Observe local regulations on the disposal of materials that are hazardous to the environment.

## 6.4 Protocol printouts

### GA46 printouts, in English

#### Straight weighing

```
XXXXXXXXXXXXXXXXXXXXX
Gross          1.19 kg
Net            0.37 kg
Tare           0.82 kg
```

#### Average weighing

```
XXXXXXXXXXXXXXXXXXXXX
Gross          1.19 kg
NetAverage     0.37 kg
Tare           0.82 kg
```

#### Printout with header (standard printout)

```
METTLER TOLEDO
Tel. +49 7431 140
Germany
www.mt.com

Date          27/04/2015
Time          22:21:14
Net           0.37 kg
Tare          0.82 kg

Dev.Id        #4591-22.A
Dev.Loc       Building B9
```

#### Printout with header and identification data

```
METTLER TOLEDO
Tel. +49 7431 140
Germany
www.mt.com

Date          27/04/2015
Time          21:50:48
ID1           Company ABC
ID2           67195 Town
Net           0.57 kg
Tare          0.82 kg
Gross         1.39 kg
```





# Index

## A

---

Accessories	
for dry environment	54
for wet environment	61
Application	
Clever print	32
Average weighing	
Operation	18
Settings	32

## C

---

Calibration	25
Cleaning	
in dry environment	19
in wet environment	19
Clever print	17, 32
Connections	
Power supply	11
Weighing platform	11

## D

---

Digital I/Os	43
Dimensional drawings	
Devices for dry environment	52
Devices for wet environment	59
Display	
3-line mode	5
Metrological data line	6
Serial numbers	45
Settings	35
Symbols and info line	7
Units	26, 29
Update	31
Weight value	7
Dynamic weighing	
Operation	18
Settings	32

## E

---

Energy save	34
Error conditions	46
Error messages	47
External input	
Entry	18
Settings	40, 41

## F

---

FACT	
Settings	27
Symbol	7
Filter	27, 31

## G

---

Geo code	
Display	14
Values	63

## H

---

Hygienically sensitive areas	13
------------------------------	----

## I

---

Identifications	
Scale data	25, 29
Terminal data	35
Weighing data	18
Info key	
Displaying information	17
Settings	35
Interfaces	
Pin assignment	62

## K

---

Keyboard	
Function keys	8
Settings	35

## L

---

Levelling	10
Linearization	25
Location	10

## M

---

Maintenance	44
Menu	
Analog scale	24
Application	32
Communication	37
Display	22
IDNet Scale	29
Maintenance	44
Operation	21
Operator menu	21
Scale	24

Supervisor menu	21	Assigning	32
Metrological data line	6	Defining	43
Metrological information	63	Testing	
MinWeigh		Communication	45
Settings	27, 31	Display	45
Symbol	7	Keyboard	45
		Scale	44
<b>P</b>		<b>V</b>	
Printing	17	Verification test	20
Clever print	17	<b>W</b>	
Printout configuration	32	Warning	47
Protocol printouts	67	<b>Z</b>	
<b>R</b>		Zeroing	
Reset		Automatic	15
Application	32	Manual	15
Reset all	45	Settings	26, 30
Scale	28, 31		
Terminal	36		
Resolution	26		
Restart	26, 30		
<b>S</b>			
Safety instructions	3		
Service information	48		
Smart weighing counter	48		
Spanner icon	5, 48		
Storage battery	12		
Straight weighing	14, 32		
Supervisor menu access	36		
Switching on/off	14		
Switching units	14		
<b>T</b>			
Taring			
Automatic	15		
Automatic clearing the tare	15		
Chain tare	16		
Clearing the tare	15		
Manual	15		
Settings	26, 30		
Tare preset	16		
Technical data			
Compact scales	50		
Terminal and platform combinations	57		
Weighing terminals for dry environment	49		
Weighing terminals for wet environment	56		
Templates			



**To protect your product's future:**  
METTLER TOLEDO Service assures  
the quality, measuring accuracy and  
preservation of value of this product  
for years to come.

Please request full details about our  
attractive terms of service.

**www.mt.com**

For more information

**Mettler-Toledo (Albstadt) GmbH**

Unter dem Malesfelsen 34  
D-72458 Albstadt, Germany  
Tel. +49 7431-14 0  
Fax +49 7431-14 232  
www.mt.com

Subject to technical changes.  
© Mettler-Toledo (Albstadt) GmbH 05/2020  
30243626C en



30243626