

ICS4_6x-series

English

Quick Guide **ICS4_6x-series** Explosion-protected weighing solutions

中文

快速使用指南 **ICS4_6x 系列** 防爆称重方案

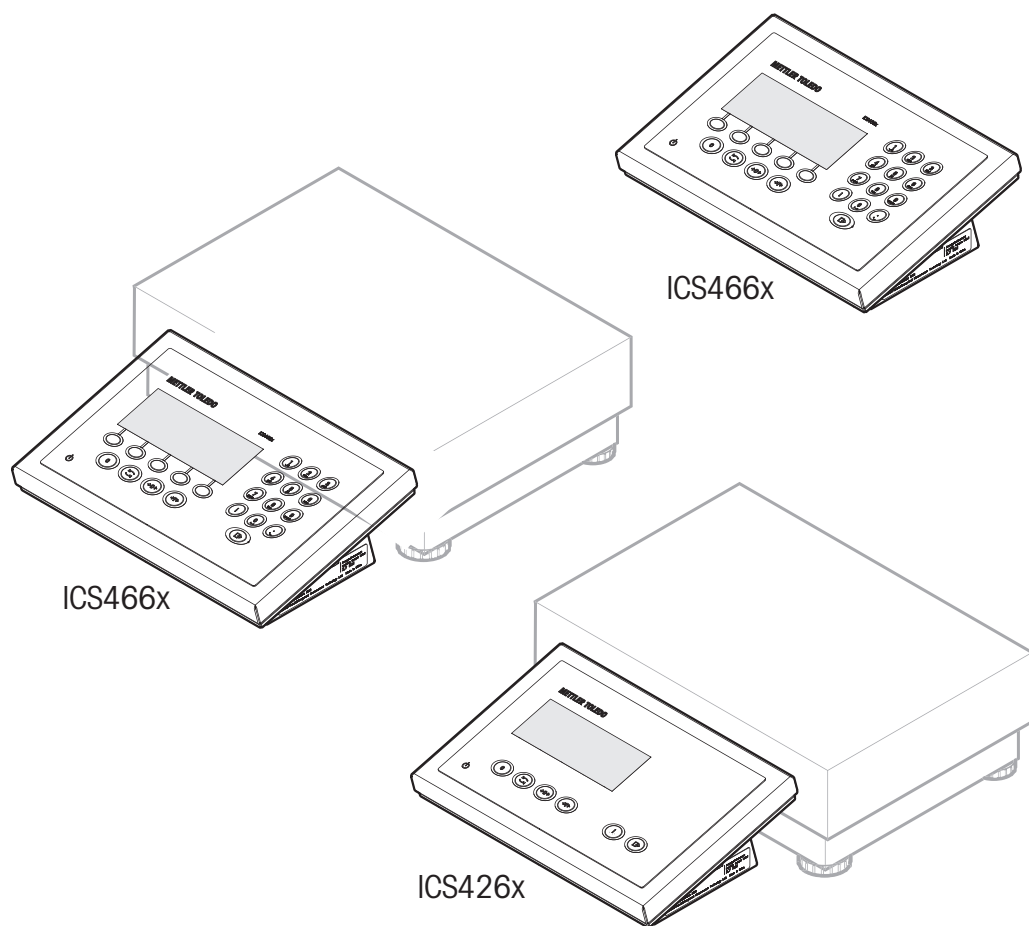

METTLER TOLEDO

METTLER TOLEDO Service

Congratulations on choosing the quality and precision of METTLER TOLEDO. Proper use of your new equipment according to this Manual and regular calibration and maintenance by our factory-trained service team ensures dependable and accurate operation, protecting your investment. Contact us about a service agreement tailored to your needs and budget. Further information is available at www.mt.com/service

There are several important ways to ensure you maximize the performance of your investment:

- 1 **Register your product:** We invite you to register your product at www.mt.com/productregistration so we can contact you about enhancements, updates and important notifications concerning your product.
- 2 **Contact METTLER TOLEDO for service:** The value of a measurement is proportional to its accuracy – an out of specification scale can diminish quality, reduce profits and increase liability. Timely service from METTLER TOLEDO will ensure accuracy and optimize uptime and equipment life.
 - ⇒ **Installation, Configuration, Integration and Training:** Our service representatives are factory-trained weighing equipment experts. We make certain that your weighing equipment is ready for production in a cost effective and timely fashion and that personnel are trained for success.
 - ⇒ **Initial Calibration Documentation:** The installation environment and application requirements are unique for every industrial scale so performance must be tested and certified. Our calibration services and certificates document accuracy to ensure production quality and provide a quality system record of performance.
 - ⇒ **Periodic Calibration Maintenance:** A Calibration Service Agreement provides on-going confidence in your weighing process and documentation of compliance with requirements. We offer a variety of service plans that are scheduled to meet your needs and designed to fit your budget.

Table of Contents

1	Safety instructions	3
1.1	Intended use	3
1.2	Misuse	3
1.3	Safety notes for operation in hazardous areas	3
2	Introduction	4
2.1	Weighing terminals of the ICS4_6x-series	4
2.2	About this document	4
2.3	Further documents	4
3	Installation	5
3.1	Installation, configuration service and repair	5
3.2	Leveling	5
4	Operation	6
4.1	Display	6
4.2	Keyboard	8
4.3	Switching on/off	9
4.4	Zeroing	9
4.5	Straight weighing	9
4.6	Taring	10
4.7	Printing or transferring data	10
4.8	Switching weight unit	10
4.9	Counting (ICS466x only)	11
4.10	Over/Under Checkweighing (ICS466x only)	12
4.11	Totalizing (ICS466x only)	13
5	Maintenance	14
5.1	Cleaning	14
5.2	Disposal	14
6	Technical data	15

1 Safety instructions

1.1 Intended use

Weighing terminals of the ICS4_6x-series are part of a modular explosion-protected weighing system consisting of a METTLER TOLEDO weighing terminal as indicator and at least one weighing platform.

Weighing terminals of the ICS4_6x-series are approved for operation in hazardous areas of Category 2 / Division 1.

- Use the weighing terminal only for weighing in accordance with this Quick guide and the corresponding User manual.
- The weighing terminal is intended for indoor use only.
- Any other type of use is considered as not intended.

Legal metrology

- For use in legal metrology, only use approved weighing systems.
- When using in legal metrology, the operating company is responsible for observing all national weights & measurements requirements.
- Please contact the METTLER TOLEDO Service organization for questions related to the use in legal for trade applications.

1.2 Misuse

- Do not use the weighing terminal other than for weighing operations.
- Do not modify the weighing terminal.
- Do not use the weighing terminal beyond the limits of the technical specifications.

1.3 Safety notes for operation in hazardous areas

Weighing terminals of the ICS4_6x-series are approved for operation in Category 2 / Division 1 hazardous areas.

The operating company is responsible for the safe operation of the explosion-protected weighing system.



DANGER

Explosion hazard

- 1 Strictly observe the instructions of the operating company.
- 2 Comply with all national regulations for operation in hazardous areas, as well as the instructions and information in this Quick guide.

2 Introduction

2.1 Weighing terminals of the ICS4_6x-series

This Quick guide focuses on the following weighing terminals:

Type	Numeric keypad	Soft keys	Environment	Terminal and platform combination
ICS426x	–	–	Category 2 / Division 1	with PBK9-/PFK-9 series with option Category 2 / Division 1
ICS466x	x	x		optional, e.g., with PBK9-/PFK-9 series with option Category 2 / Division 1 or PBA430x

Scale interfaces

Weighing terminals of the ICS4_6x-series are available with various scale interfaces. The built-in scale interface is indicated directly after the terminal type.

ICS4_6xa	...d
Scale interface	analog (ICS466x only)	IDNet / SICSpro

2.2 About this document



This document contains all information for the **operator** of the weighing terminals of the ICS4_6x-series.

- Read this document carefully before use.
- Keep this document for future reference.
- Pass this document on to any future owner or user of the product.

2.3 Further documents

In addition to this printed document you can download the following documents from <http://www.mt.com>:

- Operator manuals
- Technical manuals
- Installation manuals
- Data sheets
- Videos
- Brochures
- Type approval documents
- For terminal and platform combinations: User manuals of the connected weighing platforms

Type approval documents

ICS4_6x	Category 2	BVS 13 ATEX E042X IECEX BVS 13.0050X
	Division 1	FM16US00098

3 Installation

3.1 Installation, configuration service and repair

- For installation, configuration, service and repair of an explosion-protected weighing system call the METTLER TOLEDO Service.

3.2 Leveling

ICS4_6x weighing terminals are available as terminal and platform combination.

Only weighing platforms that have been leveled precisely horizontally provide accurate weighing results. Weights and Measures approved weighing platforms have a level bubble to simplify levelling.

- Turn the adjustable feet of the weighing platform until the level bubble's air bubble is inside the inner circle.

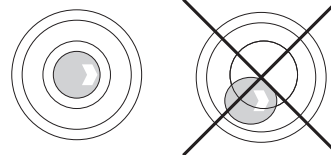

4 Operation

4.1 Display

4.1.1 Default layout

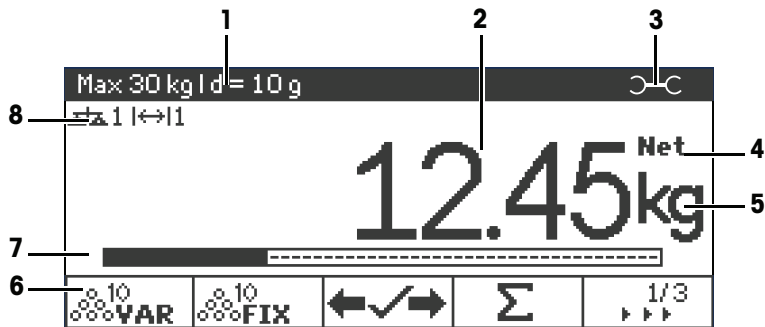

- 1 Metrological data line
- 2 Weight value
- 3 Spanner icon: service needed
- 4 Net/Gross
- 5 Unit
- 6 Soft keys (factory setting, page 1, ICS466x only)
- 7 Auxiliary data line: The contents is defined in the menu, see User manual.
- 8 Symbols and info line

Metrological data line

i The metrological data is stored in the weighing platform. The weighing terminal only serves as indicator.

In the metrological data line, the following information is displayed:

Symbol	Information
	Accuracy classes
W1 , W2 , W3	Weighing range information
Max , cap	Maximum capacity
Min	Minimum capacity
e =	Approved resolution
d =	Display resolution
Approved scale	Approved weighing device
-10 °C ... +40 °C	Temperature range





4.1.2 Weight value

The weight value can be marked with the following symbols:

Symbol	Information
*	Calculated weight value
—	Sign for negative weight values
○	Stability monitor for unstable weight values
1.234₃ kg	Non-approved last digit with $e > d$







4.1.3 Symbols and info line

In the symbols and info line the following information can be displayed. For more symbols, refer to the User manual.

Symbol	Information	Availability
	Scale number	Not for ICS426x
	Weighing range	For multi range or multi interval scales only
	Weight below minimum weight	
	Automatic taring	
	Automatic clearing of the tare weight	
>0<	Center of zero indication	Depending on local Weights and Measures regulations
Σ	Totalization	Not for ICS426x
Fact	Fact needs to be done	Displayed only if the function is supported by the weighing platform, e.g., PBK9-/PFK9-series







4.2 Keyboard

4.2.1 Function keys

Key	Name	Key	Name
	Power		Tare
	Clear		Info
	Switch		Transfer
	Zero		

4.2.2 Main soft keys (ICS466x only)

To meet your specific application requirements, ICS466x weighing terminals offer soft keys which can be configured in the menu. For more soft keys, refer to the User manual.

ICS4_6x	Menu setting	Function
	Ref n var	Determine the average piece weight, freely adjustable
	Ref n fix	Determine the average piece weight, fixed reference sizes
	Weight/count	Switch between weight display and display of pieces
	Totalizing	Start totalizing
	Over/Under Checkweighing	Enter Over/Under Checkweighing parameters
	Save article	Save the current article parameters in the database
	Recall article	Recall parameters from the database

4.3 Switching on/off

Switching on

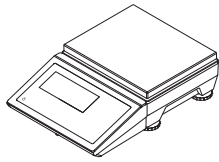

Switching off

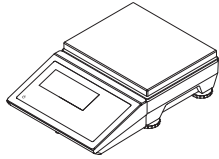

Press and hold  until **OFF** is displayed.

4.4 Zeroing

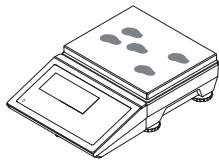

Zeroing corrects the influence of slight changes on the load plate or minor deviations from the zero point.

4.5 Straight weighing

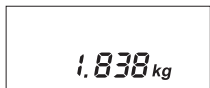
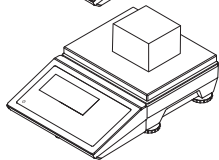
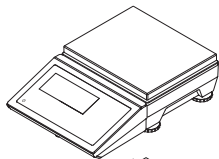

4.6 Taring

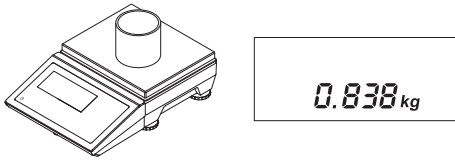

When the scale is tared, the NET symbol is displayed.

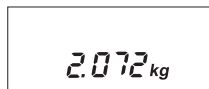
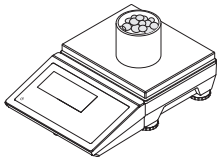

When the tare is cleared, the gross weight is displayed.

4.7 Printing or transferring data

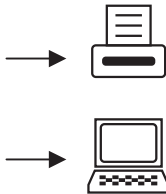
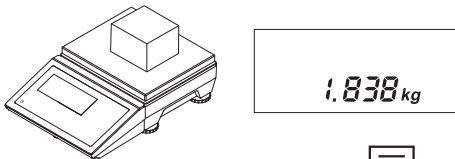

- The printer or computer has to be located in the safe area.
- The data have to be transferred to the safe area via the ACM200 interface converter.

4.8 Switching weight unit

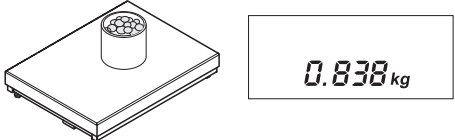

4.9 Counting (ICS466x only)

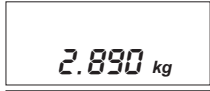
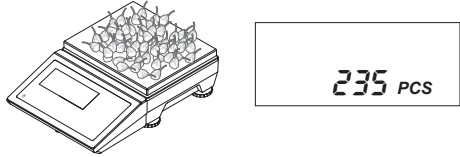
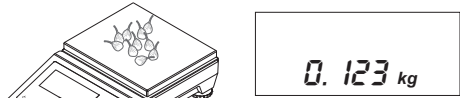
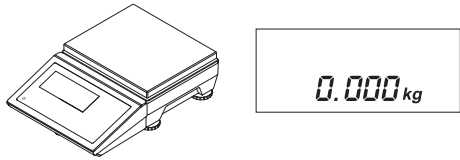

Clearing counting

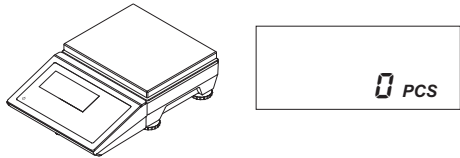







Use the number of reference parts indicated on the soft key, in this example: 10 pieces.

Switch between the display of the number of pieces and of the weight.

Press the **C** key to clear the counting parameters. The weight is displayed.

4.10 Over/Under Checkweighing (ICS466x only)

Setting target values

	<table border="1"> <tr><td>Tol. type:</td><td>Absolute</td></tr> <tr><td>Low:</td><td>0.00 kg</td></tr> <tr><td>High:</td><td>0.00 kg</td></tr> </table>	Tol. type:	Absolute	Low:	0.00 kg	High:	0.00 kg
Tol. type:	Absolute						
Low:	0.00 kg						
High:	0.00 kg						
	<table border="1"> <tr><td>Tol. type:</td><td>Absolute</td></tr> <tr><td>Low:</td><td>0.00 kg</td></tr> <tr><td>High:</td><td>0.00 kg</td></tr> </table>	Tol. type:	Absolute	Low:	0.00 kg	High:	0.00 kg
Tol. type:	Absolute						
Low:	0.00 kg						
High:	0.00 kg						
	<table border="1"> <tr><td>Tol. type:</td><td>Absolute</td></tr> <tr><td>Low:</td><td>9.5 kg</td></tr> <tr><td>High:</td><td>0.00 kg</td></tr> </table>	Tol. type:	Absolute	Low:	9.5 kg	High:	0.00 kg
Tol. type:	Absolute						
Low:	9.5 kg						
High:	0.00 kg						
	<table border="1"> <tr><td>Tol. type:</td><td>Absolute</td></tr> <tr><td>Low:</td><td>9.5 kg</td></tr> <tr><td>High:</td><td>0.00 kg</td></tr> </table>	Tol. type:	Absolute	Low:	9.5 kg	High:	0.00 kg
Tol. type:	Absolute						
Low:	9.5 kg						
High:	0.00 kg						
	<table border="1"> <tr><td>Tol. type:</td><td>Absolute</td></tr> <tr><td>Low:</td><td>9.5 kg</td></tr> <tr><td>High:</td><td>10.4 kg</td></tr> </table>	Tol. type:	Absolute	Low:	9.5 kg	High:	10.4 kg
Tol. type:	Absolute						
Low:	9.5 kg						
High:	10.4 kg						
	<table border="1"> <tr><td colspan="2">New target set!</td></tr> </table>	New target set!					
New target set!							
<table border="1"> <tr><td>LW: 9.50kg</td><td>HI: 10.40kg</td></tr> </table>		LW: 9.50kg	HI: 10.40kg				
LW: 9.50kg	HI: 10.40kg						

For other tolerance types, refer to the User manual.

You can either weigh the target weight or enter it numerically.

Over/Under Checkweighing display

	Weight within the tolerances
	Weight above the tolerances
	Weight below the tolerances

Leaving Over/Under Checkweighing

- esc** Leave Over/Under Checkweighing, but keep the target values.
- C** Leave Over/Under Checkweighing and clear target values.

4.11 Totalizing (ICS466x only)

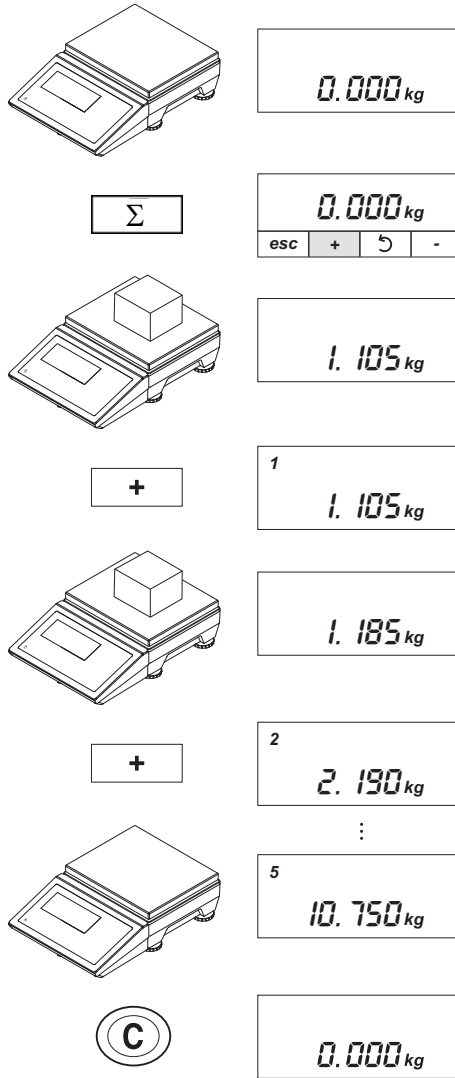

The totalizing soft keys are displayed.

1st item totalized.

Unload the scale and place the 2nd item.

2nd item totalized.

5 items totalized and last item removed.

Total cleared.

5 Maintenance

Maintenance of the weighing terminal is limited to regular cleaning.

5.1 Cleaning



WARNING

Explosion hazard

- 1 Strictly observe the instructions of the operating company.
- 2 Avoid electrostatic charging by wearing suitable working clothes when operating in hazardous areas.

Notes on cleaning

- Only use a clean damp cloth and gently wipe the keypad.
- Use water or mild, non-abrasive cleaning agents.
- Do not spray cleaner directly on the weighing terminal.
- Do not use any acids, alkalis or strong solvents.
- Do not clean the weighing terminal using high-pressure or high-temperature water.
- Observe all existing regulations on cleaning intervals and permissible cleaning agents.
- Do not use compressed air or vacuum.
- Remove dust layers.

5.2 Disposal

In accordance with the requirements of European Directive 2002/96 EC on Waste Electrical and Electronic Equipment (WEEE), this device may not be disposed of with domestic refuse. This also applies for countries outside the EU in accordance with their respective national regulations.

- Please dispose of this product in accordance with local regulations for the separate collection of waste electrical and electronic equipment.



Should you have any questions, please contact the corresponding authorities or the dealer from whom this device was purchased.

If this device is passed on (for example for further private or commercial/industrial use), this regulation is also to be passed on.

Many thanks for your contribution to the protection of the environment.

6 Technical data

Weighing terminals		ICS426x	ICS466x
Housing		Stainless steel	
Display		Monochrome LCD graphical display Backlighting	Monochrome LCD graphical display Colored backlighting
Keyboard		Tactile touch membrane keypad (PET), scratch-resistant labeling	
Net weight		2.8 kg / 6.1 lb	
Protection type		IP65	
Mains connection		via APS768x	
Ambient conditions	Application	indoor use only	
	Temperature range Class III	-10 °C ... 40 °C / 14 °F ... 104 °F	
	Humidity	Max. rel. humidity 85 %, for temperatures up to 40 °C / 104 °F	
Ignition protection type	EN/IECEX	II 2G Ex ib IIC T4 Gb, -10 °C ... + 40 °C II 2D Ex ib IIIC T60°C Db IP65	
	cFM _{US}	IS Class I, II, III; Division 1 Group A, B, C, D, E, F, G; T4; Ta = 40 °C Aex ib IIC T4; IP65; Type 4	
W & M approvals		OIML Class II, III, IIII NTEP Class II, III	
Interfaces		1 interface RS232-IS and 1 scale interface integrated 1 additional optional communication interface	1 interface RS232-IS and 1 scale interface integrated 1 additional optional communication interface 1 additional optional scale interface
Applications		Straight weighing Average weighing Clever print	Straight weighing Average weighing Clever print Over/Under Checkweighing Counting Totalizing Database Prompting Alibi Memory

Analog scale interface (ICS466x only)	
Impedance	80 ... 3,000 Ohms
Excitation	3.3 V
Sensitivity	up to 3 mV/V
Max. resolution	10,000 e (OIML) 300,000 d (non approvable)
Min. verification interval	0.26 μ V/e

Dimensional drawing ICS4_6x-series

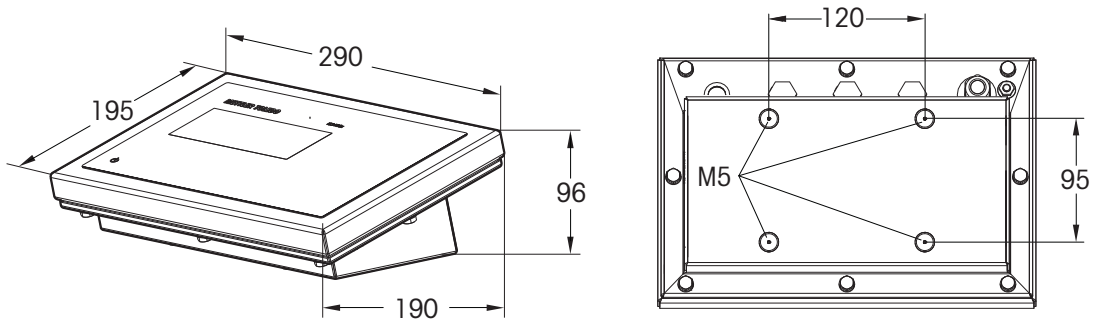

METTLER TOLEDO Service

恭喜您选择了 METTLER TOLEDO 的品质与精密。如果您能够依照本手册正确使用新设备，并且由我们厂商培训的服务团队进行定期校准和维护，本设备将能可靠与精确地运行，保证您购买的产品物有所值。如需了解按照您的需求和预算量身定制的服务协议，请联系我们。欲知详情，请登陆

www.mt.com/service

为了让您购买的设备发挥最高性能，须注意下列几点：

- 1 **注册您的产品：**我们邀请您在 www.mt.com/productregistration 注册您的产品，以便我们通知您与产品有关的增强功能、更新及重要通知。
- 2 **联系 METTLER TOLEDO 进行维护：**量具的价值与其精确度成正比——不合格的秤台会降低品质、减少利润并增加责任风险。由 METTLER TOLEDO 及时进行维护能够保证精确，延长设备的运行时间及使用寿命。
 - ⇒ **安装、配置、集成与培训：**我们的服务代表均为厂商培训的称重设备专家。我们承诺我们的称重设备能够经济并及时地生产，并且我们的员工训练有素。
 - ⇒ **初次校准文件：**每个工业秤都有其独有的安装环境及应用要求，所以需要对其运行情况进行测试和验证。我们的校准服务及验证文件精确无误，保证了生产质量，并能提供良好的系统运行记录。
 - ⇒ **定期校准维护：**校准服务协议让我们对于您的称重程序和遵守规程证明充满信心。我们提供多样化的服务计划，专为您的需求和预算而定制。

1	安全说明	3
1.1	预期用途	3
1.2	误用	3
1.3	危险区域的安全操作说明	3
2	说明	4
2.1	ICS4_6x 系列称重仪表	4
2.2	关于此文件	4
2.3	其他相关文件	4
3	安装	5
3.1	安装、配置服务与维修	5
3.2	调平	5
4	操作	6
4.1	显示屏	6
4.2	键盘	8
4.3	打开/关闭	9
4.4	归零	9
4.5	简单称重	9
4.6	去皮	10
4.7	打印或传输数据	10
4.8	切换重量单位	10
4.9	计数（仅适用于 ICS466x）	11
4.10	过载/欠载（仅适用于 ICS466x）	12
4.11	累加称重（仅适用于 ICS466x）	13
5	维护	14
5.1	清洁	14
5.2	废弃处置	14
6	技术规格	15

1 安全说明

1.1 预期用途

ICS4_6x 系列称重仪表是模块化防爆称重系统的组成部分，防爆称重系统包含一个作为指示器的 METTLER TOLEDO 称重仪表以及至少一个秤体。

ICS4_6x 系列称重仪表经认证可用于 Category 2 / Division 1 危险区域。

- 根据此《快速指南》与相应的《用户手册》仅将称重仪表用于称重。
- 此称重仪表仅供室内使用。
- 任何其他类型的使用视为非预期使用。

法定计量

- 对于法定计量方面的使用，仅可使用经认证的称重系统。
- 在用于法定计量方面时，操作公司有责任遵守国家制定的所有度量衡要求。
- 对于与贸易应用法规相关的使用如有疑问，请联系 METTLER TOLEDO 服务组织。

1.2 误用

- 请勿将称重仪表用于称重操作以外的用途。
- 请勿改动称重仪表。
- 请勿超出技术规格范围使用称重仪表。

1.3 危险区域的安全操作说明

ICS4_6x 系列称重仪表经认证可用于 Category 2 / Division 1 危险区域。

操作公司负责防爆称重系统的安全操作。



⚠ 危险

爆炸危险

- 1 严格遵守使用公司说明。
- 2 遵守国家关于危险区域操作的所有条例以及此《快速指南》中的相关说明与信息。

2 说明

2.1 ICS4_6x 系列称重仪表

此《快速指南》重点说明以下称重仪表：

类型	数字小键盘	软键	环境	仪表与秤体组合
ICS426x	–	–	Category 2 / Division 1	适用于 PBK9-/PFK-9 系列 提供 Category 2 / Division 1 选配设置
ICS466x	x	x		选配式，例如，在 PBK9-/PFK-9 系列上 提供 Category 2 / Division 1 或 PBA430x 选配设置

秤台接口

ICS4_6x 系列称重仪表提供各种秤台接口。内置型秤台接口直接显示在仪表型号之后。

ICS4_6xa	...d
秤台接口	模拟（仅限 ICS466x）	IDNet / SICSprö

2.2 关于此文件



此文件包含适用于 ICS4_6x 系列称重仪表**操作员**的所有信息。

- 请在使用前认真阅读此文件。
- 妥善保管此文件供将来参考用。
- 将此文件转交给此产品的今后任何所有者或用户。

2.3 其他相关文件

除了此份打印文件，您还可以从 <http://www.mt.com> 下载以下文件：

- 操作员手册
- 技服手册
- 安装手册
- 数据表
- 视频
- 产品小册子
- 相关认证文档
- 对于仪表与秤体组合：所连接的称体的《用户手册》

相关认证文档

ICS4_6x	Category 2	BVS 13 ATEX E042X IECEX BVS 13.0050X
	Division 1	FM16US00098

3 安装

3.1 安装、配置服务与维修

- 要安装、配置、维护与维修防爆称重系统，请致电 METTLER TOLEDO 服务部。

3.2 调平

ICS4_6x 称重仪表可作为仪表与秤体组合使用。

秤体只有经过精确的水平校准，方可获得准确的称重结果。符合度量衡规范的秤体有一个调平水泡，可简化调平过程。

- 转动秤体的调节脚，直至调平水泡中的气泡位于内圆中。

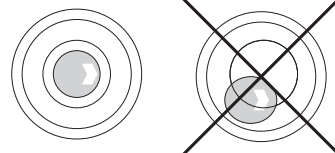

4 操作

4.1 显示屏

4.1.1 默认输出

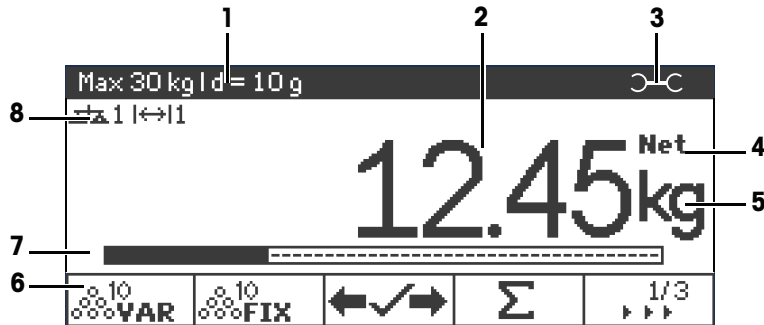

- 1 计量数据行
- 2 称重值/称重结果
- 3 扳手图标：需要维修
- 4 净重/毛重
- 5 单位
- 6 软键（出厂设置，第 1 页，仅 ICS466x）
- 7 辅助数据行：内容如菜单所定义；参见《用户手册》
- 8 图标和信息行

计量数据栏

i 计量数据将储存在秤台中。称重仪表仅用作指示器。

计量数据栏显示如下信息：

符号	信息
	精度等级
W1 、 W2 、 W3	称重范围信息
Max 、 cap	最大量程
Min	最小量程
e =	认证分度
d =	显示分度
Approved scale	认证称量设备
-10 °C ... +40 °C	温度范围



4.1.2 称重值/称重结果

称重值/称重结果可用如下符号标识：

符号	信息
*	所计称重值/称重结果
—	负称重值/称重结果符号
○	针对不稳定称重值/称重结果的稳态图表
1.234₃ kg	e>d 时不核准最后一位数字







4.1.3 图标和信息行

图标和信息行将显示如下信息。如欲了解更多符号，请参考《用户手册》。

符号	信息	适用性
	秤台号	不适用于 ICS426x
<->	称重范围	仅用于多范围或多分度秤台
	重量低于最小重量	
	自动去皮	
	自动皮重清零	
>0<	零中心刻度指示	根据当地度量衡规范
Σ	累加	不适用于 ICS426x
Fact	需进行全自动校准	仅当秤体支持此功能时方显示，例如 PBK9-/PFK9 系列







4.2 键盘

4.2.1 功能键

键	名称	键	名称
	电源		去皮
	清零		信息
	切换		转换
	清零		

4.2.2 主要软键（仅适用于 ICS466x）

为满足您的特定应用要求，可在 ICS466x 称重仪表菜单中配置软键。如欲了解更多软键，请参考《用户手册》。

ICS4_6x	菜单设置	功能
	自定义采样	确定平均单重，可自由调整
	固定采样	确定平均单重，采样大小固定
	称重/计数	在重量显示与单件显示之间切换
	累加称重	开始累加称重
	过载/欠载	输入过载/欠载参数
	保存日志	将当前数量参数保存至数据库
	调用日志	从数据库中读取参数

4.3 打开/关闭

打开

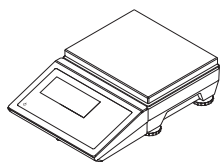

关闭

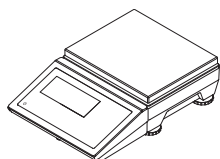

长按  直至显示 **OFF** (关闭)。

4.4 归零

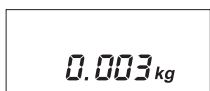
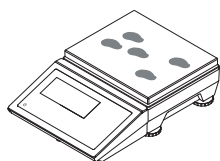

清零可以消除承重盘上轻微变化所带来的影响，或是纠正零点上的微弱偏差。

4.5 简单称重

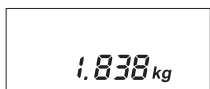
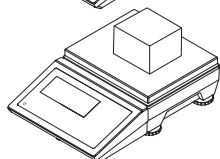
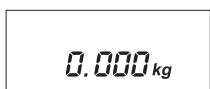
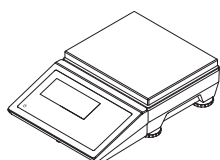

4.6 去皮

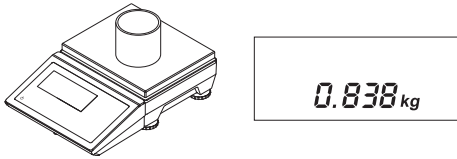

在对秤台去皮时，显示“净重”符号。

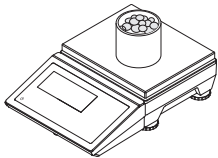

在去皮清零时，显示总重。

4.7 打印或传输数据

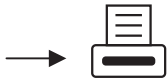
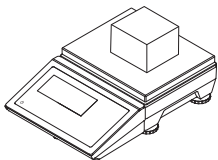

- 应将打印机或电脑放置在安全区域。
- 通过 ACM200 接口转接头将数据传输至安全区域。

4.8 切换重量单位

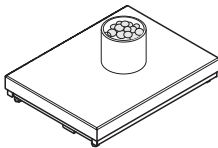

4.9 计数（仅适用于 ICS466x）

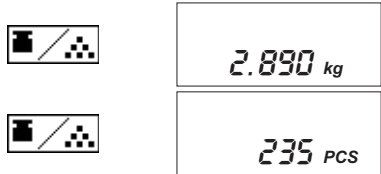
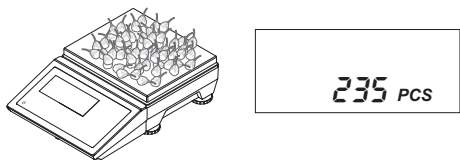
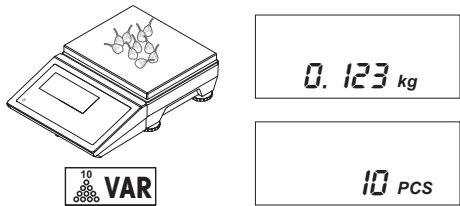
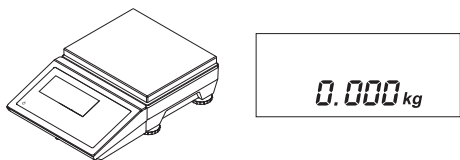

清零计数

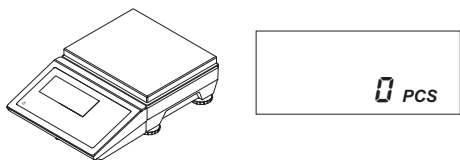

使用软键上显示的采样部件的数量，本例中为：10 件。

在件数与重量显示之间切换。

按下 **C** 键清零计数参数。显示重量。

4.10 过载/欠载（仅适用于 ICS466x）

设置目标值

The diagram illustrates the process of setting a target weight. It starts with selecting the tolerance type as 'Absolute'. The initial target is 0.00 kg. The user then inputs a target weight of 9.5 kg. The resulting target range is shown as Lw: 9.50kg and HI: 10.40kg.

如欲了解其他公差类型，请参考《用户手册》。

您可以对目标重量进行称重或输入其重量数值。

过载/欠载显示

The diagram shows three scenarios of weight display:

- 重量在公差范围内 (Weight within tolerance range): The display shows a green bar with Lw: 9.50kg and HI: 10.40kg.
- 重量高于公差范围 (Weight above tolerance range): The display shows a yellow bar with Lw: 9.50kg and HI: 10.40kg.
- 重量低于公差范围 (Weight below tolerance range): The display shows a red bar with Lw: 9.50kg and HI: 10.40kg.

退出过载/欠载

- esc** 退出过载/欠载，但保留目标值。
- C** 退出过载/欠载，并清零目标值。

4.11 累加称重（仅适用于 ICS466x）

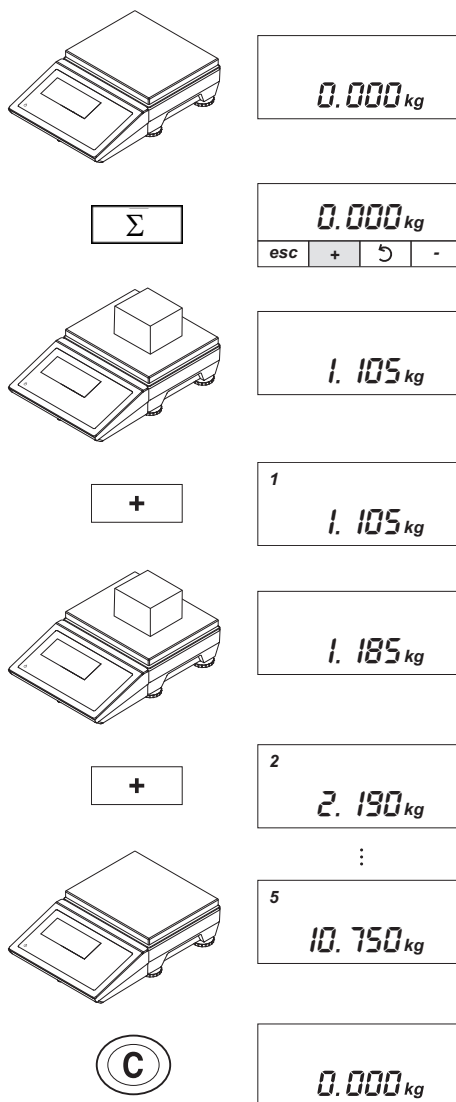

显示累加称重软键。

对第1个商品进行累加称重。

清除秤台上的称重物并放置第2个商品。

对第2个商品进行累加称重。

对5个商品进行累加称重并清除最后一个商品。

清除总计。

5 维护

称重仪表的维护限于定期清洁：

5.1 清洁



警告

爆炸危险

- 1 严格遵守使用公司说明。
- 2 在危险区域进行操作时，应穿戴合适的工作装以避免产生静电。

有关清洁的注意事项

- 仅用干净的湿布轻柔地擦拭键盘。
- 使用水或温和的非腐蚀性清洁剂。
- 请勿将清洁剂直接喷撒在称重仪表上。
- 请勿使用任何酸、碱或强溶剂。
- 请勿用高压水或高温水清洁称重仪表。
- 请完全遵照现行规范，按对应清洁周期，利用允许使用之清洁剂进行清洁。
- 请勿使用压缩空气或真空吸尘器。
- 清除灰尘。

5.2 废弃处置

根据有关废弃电气和电子设备 (WEEE) 的欧盟指令 2002/96 EC 的要求，该设备不得与生活垃圾共同处置。这也适用于欧盟以外的国家，同时须遵守各个国家的相关法规。

- 请根据当地有关单独收集废弃电气和电子设备法规来处置该产品。

如您有任何疑问，请联系相关部门或向您销售该设备的经销商。

如果该设备转用在其他方面（如用于其他私人或商业/工业用途），该法规也将同样适用。

感谢您为保护环境做出的努力。



6 技术规格

称重仪表		ICS426x	ICS466x
外壳		不锈钢	
显示屏		单色 LCD 图形显示屏 有背景灯	单色 LCD 图形显示屏 有颜色背景灯
键盘		触摸膜键盘 (PET), 带防刮擦标志	
净重		2.8 千克/ 6.1 磅	
保护等级		IP65	
电源连接		通过 APS768x	
环境条件	应用	仅限室内使用	
	温度范围 III 级	-10 °C ... 40 °C / 14 °F ... 104 °F	
	湿度	在温度高达 40 °C / 104 °F 时, 最大相对湿度为 85 %	
点火保护等级	EN/IECEX	II 2G Ex ib IIC T4 Gb, -10 °C ...+40 °C II 2D Ex ib IIIC T60°C Db IP65	
	cFM _{US}	IS Class I、II、III ; Division 1 Group A、B、C、D、E、F、G; T4; Ta = 40 °C Aex ib IIC T4; IP65; Type 4	
W & M 认证		OIML II、III、III 级 NTEP II、III 级	
接口		1 个 RS232-IS 接口与 1 个秤台接口集成 附加 1 个选购的通讯接口	1 个 RS232-IS 接口与 1 个秤台接口集成 附加 1 个选购的通讯接口 附加 1 个选购的秤台接口
应用		简单称重 平均称重 智能打印	简单称重 平均称重 智能打印 过载/欠载 计数 累加称重 数据库 向导 Alibi 日志

模拟秤台接口 (仅适用于 ICS466x)	
电阻	80 ...3,000 欧姆
激励	3.3 V
灵敏度	最高为 3 mV/V
最大分度	10,000 e (OIML) 300,000 d (未认证)
最小检定分度值	0.26 μ V/e

ICS4_6x 系列尺寸图

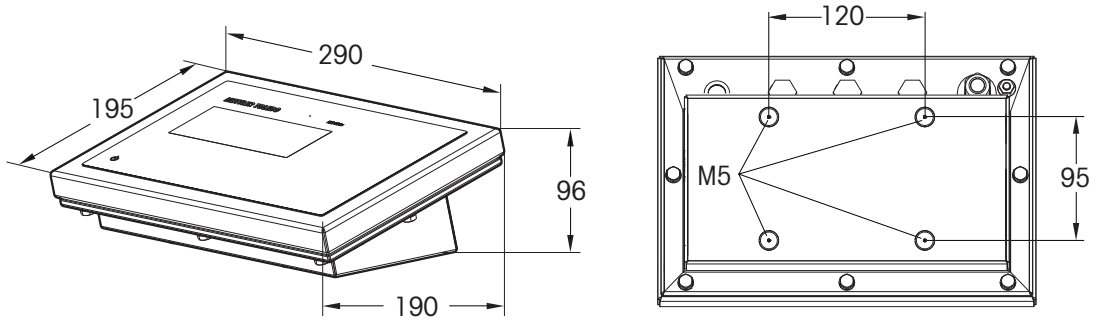

To protect your product's future:
METTLER TOLEDO Service assures
the quality, measuring accuracy and
preservation of value of this product
for years to come.

Please request full details about our
attractive terms of service.

www.mt.com

For more information

Mettler-Toledo GmbH

Im Langacher 44
8606 Greifensee, Switzerland
www.mt.com/contact

Subject to technical changes.
© Mettler-Toledo GmbH 11/2016
30361364B en zh



30361364