

Operation Manual Multi-parameter Transmitter M800



Operation Manual Multi-parameter Transmitter M800

Content

1	Introduction	9
2	Safety instructions	11
2.1	Definition of equipment and documentation symbols and designations	11
2.2	Correct disposal of the unit	12
3	Unit overview	13
3.1	Overview	13
3.1.1	1-Channel Version	13
3.1.2	2-Channel and 4-Channel Version	14
3.2	Display	15
3.2.1	Start Screen	15
3.2.2	Activation Menu Screen	15
3.3	Graphic Trend Measurement	16
3.3.1	Activation Trend Display Screen	16
3.3.2	Settings for Trend Display Screen	17
3.3.3	Deactivation Trend Display Screen	17
3.4	Control/Navigation	18
3.4.1	Menu Structure	18
3.4.2	Navigation	19
3.4.2.1	Enter the Main Menus	19
3.4.2.2	Navigating the Menu Tree	20
3.4.2.3	Exit a Menu	20
3.4.2.4	Confirm Data and Values	20
3.4.2.5	Return to the Menu Screen	20
3.4.3	Entry of Data	20
3.4.4	Selection Menus	20
3.4.5	"Save changes" Dialog	20
3.4.6	Security Passwords	21
3.4.7	Display	21
4	Installation instruction	22
4.1	Unpacking and inspection of equipment	22
4.1.1	Panel cutout dimensional information	22
4.1.2	Installation procedure	23
4.1.3	Assembly	23
4.1.4	Dimension drawings	24
4.1.5	Pipe mounting	25
4.2	Connection of power supply	25
4.3	Terminal Definition	26
4.3.1	M800 1-channel	26
4.3.1.1	InPro8000 Series Turbidity Sensor	27
4.3.2	M800 2-channel	28
4.3.3	M800 4-channel	29
4.3.4	M800 1-channel: TB2 – Conductivity 2e/4e Analog Sensors	30
4.3.5	M800 1-channel: TB2 – pH/ORP Analog Sensors	30
4.3.6	M800 1-channel: TB2 – Oxygen Analog Sensors	31
4.3.7	M800 2- and 4-channel: TB2 and TB4 – Terminal Assignment for Optical Oxygen, CO ₂ hi, UniCond2e, UniCond4e and 5000TOCi ISM Sensors	32
4.3.8	M800 2- and 4-channel: TB2 and TB4 – Terminal Assignment for pH, Amp. Oxygen, Cond 4e, CO ₂ and O ₃ ISM Sensors	33
4.3.9	M800 1-channel: TB3 – Terminal Assignment for Optical Oxygen, CO ₂ hi, UniCond2e and UniCond4e ISM Sensors	34
4.3.10	M800 1-channel: TB3 – Terminal Assignment for pH and Turbidity ISM Sensors	35
4.3.11	M800 2- and 4-channel Water: TB3 – Terminal Assignment for Flow Sensors	35
4.4	Connection of Flow Sensor	36
4.4.1	Flow Sensor Input Wiring Kit	36
4.4.2	Kit Contents	36
4.4.3	Flow sensor wiring for Compatible Sensors	36
4.4.4	Wiring for "HIGH" type flow sensors	37
4.4.5	Wiring for "LOW" type flow sensors	39
4.4.6	Wiring for "TYPE 2" flow sensors	39

5	Placing transmitter in, or out, of service	40
5.1	Placing transmitter in service	40
5.2	Placing transmitter out of service	40
6	Guided Setup	41
7	Calibration	42
7.1	Sensor Calibration	42
7.2	Calibration of UniCond2e and UniCond4e Sensors (ISM Sensors only)	42
7.2.1	Conductivity Calibration of UniCond2e and UniCond4e Sensors	42
7.2.1.1	One-Point Calibration	44
7.2.1.2	Two-Point Calibration	45
7.2.1.3	Process Calibration	46
7.2.2	Temperature Calibration of UniCond2e Sensors and UniCond4e Sensors	47
7.2.2.1	One-Point Calibration	47
7.2.2.2	Two-Point Calibration	48
7.3	Calibration of Cond2e Sensors or Cond4e Sensors	50
7.3.1	One-Point Calibration	50
7.3.2	Two-Point Calibration	51
7.3.3	Process Calibration	51
7.4	pH Calibration	52
7.4.1	One-Point Calibration	52
7.4.2	Two-Point Calibration	53
7.4.3	Process Calibration	54
7.5	ORP Calibration of pH Sensors	54
7.6	Calibration of Amperometric Oxygen Sensors	55
7.6.1	One-Point Calibration	55
7.6.2	Process Calibration	56
7.7	Calibration of Optical Oxygen Sensors (ISM Sensors only)	57
7.7.1	One-Point Calibration	57
7.7.2	Two-Point Calibration	58
7.7.3	Process Calibration	58
7.8	Calibration of Dissolved Carbon Dioxide Sensors (ISM Sensors only)	59
7.8.1	One-Point Calibration	59
7.8.2	Two-Point Calibration	60
7.8.3	Process Calibration	60
7.9	Calibration of Thermal Conductivity CO ₂ (CO ₂ high) Sensors (ISM Sensors only)	61
7.9.1	One-Point Calibration	61
7.9.2	Process Calibration	62
7.10	Calibration of O ₃ Sensors (ISM Sensors only)	62
7.10.1	One-Point Calibration	63
7.10.2	Process Calibration	64
7.11	Calibration of Flow Sensors (ISM Sensors only)	65
7.11.1	One-Point Calibration	65
7.11.2	Two-Point Calibration	66
7.12	Turbidity Calibration (InPro8000 Series)	67
7.12.1	Multi-Point Calibration	68
7.12.2	Process Calibration	69
7.12.3	In-Situ Calibration	70
7.12.4	Manual Calibration (Edit)	72
7.13	Turbidity Calibration (InPro8600i)	72
7.13.1	Process Calibration	73
7.14	Sensor Verification	74
7.15	Edit Calibration Constants for Flow Sensors	74
7.16	UniCond2e Electronics Calibration	75
7.17	Meter Calibration	75
7.17.1	Resistance (Analog Sensors only)	75
7.17.2	Temperature (Analog Sensors only)	77
7.17.3	Voltage	77
7.17.4	Current	78
7.17.5	R _g	78
7.17.6	R _r	78
7.17.7	Flow meter calibration	79
7.18	Flow Meter Verification	80
7.19	Analog Output Calibration	80
7.20	Analog Input Calibration	81
7.21	Maintenance	81

8	Configuration	82
8.1	Measurement	82
8.1.1	Channel Setup	82
8.1.2	Derived Measurements	84
8.1.2.1	% Rejection measurement	84
8.1.2.2	Calculated pH (Power Plant Applications only)	84
8.1.2.3	Calculated CO ₂ (Power plant applications only)	85
8.1.3	Display Mode	85
8.1.4	Parameter related Settings	86
8.1.4.1	Conductivity Settings	86
8.1.4.2	pH Settings	87
8.1.4.3	Settings for Oxygen Measurement Based on Amperometric Sensors	88
8.1.4.4	Settings for Oxygen Measurement Based on Optical Sensors	89
8.1.4.5	Dissolved Carbon Dioxide Settings	90
8.1.4.6	Settings for Thermal Conductivity Dissolved CO ₂ Measurement (CO ₂ hi)	91
8.1.4.7	Settings for TOC Measurement	91
8.1.4.8	Settings for Flow Measurement	92
8.1.4.9	Settings for Turbidity Sensors (InPro8000 Series)	92
8.1.4.10	Settings for Turbidity Sensors (InPro8600i)	92
8.1.4.11	Deionization Capacity (DI-Cap™)	93
8.1.5	Concentration Curve Table	94
8.2	Temperature Source (Analog Sensors only)	94
8.3	Analog Outputs	95
8.4	Set Points	96
8.5	ISM Setup (ISM Sensors only)	97
8.5.1	Sensor Monitor	97
8.5.2	CIP Cycle Limit	99
8.5.3	SIP Cycle Limit	100
8.5.4	AutoClave Cycle Limit	101
8.5.5	DLI Stress Adjustment	101
8.5.6	SAN Cycle Parameters	102
8.5.7	Reset Counters for UniCond2e Sensors	102
8.5.8	Set Calibration Interval for UniCond2e Sensors	103
8.6	General Alarm	103
8.7	ISM / Sensor Alarm	103
8.8	Clean	104
8.9	Display Setup	104
8.10	Digital Inputs	105
8.11	System	105
8.12	PID Controller	106
8.13	Service	110
8.13.1	Set Analog Outputs	110
8.13.2	Read Analog Outputs	110
8.13.3	Read Analog Inputs	110
8.13.4	Set Relay	110
8.13.5	Read Relay	110
8.13.6	Read Digital Inputs	110
8.13.7	Memory	111
8.13.8	Display	111
8.13.9	Calibrate TouchPad	111
8.13.10	Channel Diagnostic	111
8.14	Technical Service	111
8.15	User Management	112
8.16	Reset	112
8.16.1	System Reset	112
8.16.2	Reset Sensor Calibration for Optical DO Sensors	113
8.16.3	Reset Sensor Calibration for UniCond2e Sensors	113
8.16.4	Reset Total Flow	113
8.16.5	Reset for CO ₂ hi Measurement	114
8.16.6	Reset for Turbidity Sensor	114
8.17	RS485 Output	114
8.17.1	Printer Output Configuration	115
8.17.2	Data Log Configuration	115
8.18	USB Measurement Interface	116

9	ISM	117
9.1	iMonitor	117
9.2	Messages	118
9.3	ISM Diagnostics	118
9.3.1	pH/ORP, Oxygen, O ₃ and Cond4e Sensors	119
9.3.2	UniCond2e and UniCond4e Sensors	119
9.4	Calibration Data	120
9.4.1	Calibration Data for All ISM Sensors excluding UniCond2e and UniCond4e	120
9.4.2	Calibration Data for UniCond2e and UniCond4e Sensors	121
9.5	Sensor Info	121
9.6	HW / SW Version	122
9.7	Log Book	122
10	Wizards	123
10.1	Set Wizard	123
10.2	Access to Wizards	123
11	Maintenance	124
11.1	Front panel cleaning	124
12	Software History	124
12.1	M800 Process	124
12.2	M800 Water	124
13	Troubleshooting	125
13.1	Cond (resistive) Error messages/ Warning- and Alarm list for analog sensors	125
13.2	Cond (resistive) Error messages/ Warning- and Alarm list for ISM sensors	126
13.3	pH Error messages/Warning- and Alarm list	126
13.3.1	pH sensors except dual membrane pH electrodes	126
13.3.2	Dual membrane pH electrodes (pH/pNa)	127
13.3.3	ORP messages	127
13.4	Amperometric O ₂ Error messages/ Warning- and Alarm list	128
13.4.1	High level oxygen sensors	128
13.4.2	Low level oxygen sensors	128
13.4.3	Trace oxygen sensors	129
13.5	Warning- and Alarm Indication	129
13.5.1	Warning Indication	129
13.5.2	Alarm Indication	130
14	Accessories and Spare Parts	131
15	Specifications	132
15.1	General specifications	132
15.2	Electrical specifications	136
15.3	Mechanical specifications	136
15.4	Environmental specifications	137
15.5	Ex Classification	137
15.5.1	M800 4-Channel and 2-Channel versions	137
15.5.2	Type plate M800 1-Channel versions	138
16	Warranty	139
17	Buffer tables	140
17.1	Standard pH buffers	140
17.1.1	Mettler-9	140
17.1.2	Mettler-10	141
17.1.3	NIST Technical Buffers	141
17.1.4	NIST standard buffers (DIN and JIS 19266: 2000-01)	142
17.1.5	Hach buffers	142
17.1.6	Ciba (94) buffers	143
17.1.7	Merck Titrisole, Riedel-de-Haën Fixanale	143
17.1.8	WTW buffers	144
17.1.9	JIS Z 8802 buffers	144
17.2	Dual membrane pH electrode buffers	145
17.2.1	Mettler-pH/pNa buffers (Na ⁺ 3.9M)	145

1 Introduction

Statement of Intended Use – The M800 Multi-parameter transmitter is an online process instrument for measuring various properties of fluids and gases. These include conductivity, dissolved oxygen, O₂ gas, dissolved ozone, dissolved carbon dioxide, pH/ORP, flow and turbidity. The M800 is available in different versions. The version indicates the amount of measurement parameters which can be covered and the kind of parameter. The version are indicated through there part numbers on the label of the transmitter.

M800 parameter fit guide for 2-channel and 4-channel version

These versions are compatible with the following (digital) ISM and flow sensors.

Version Part no.	Water 2-ch 58 000 802	Water 4-ch 58 000 804	Process 2-ch 52 121 813	Process 4-ch 52 121 853
pH/ORP	•	•	•	•
pH/pNa	–	–	•	•
UniCond2e	•	•	•	•
UniCond4e	•	•	•	•
Cond4e	•	•	•	•
Amp. DO ppm/ppb/trace	•/•/•*	•/•/•*	•/•/•**	•/•/•**
Amp. O ₂ gas ppm/ppb/trace	–/–/–*	–/–/–*	•/•/•**	•/•/•**
Optical DO	•***	•***	•***	•***
Dissolved Carbon Dioxide	–	–	•	•
CO ₂ hi (thermal conductivity)	–	–	•***	•***
TOC	•	•	–	–
Dissolved O ₃	•	•	–	–
Flow	•	•	–	–

* THORNTON sensors

** INGOLD sensors

*** One (two) optical DO or thermal conductivity CO₂ sensor(s) can be used together with 2-channel (4-channel) transmitter M800.

M800 parameter fit guide for 1-channel version

These version is compatible with the following (digital) ISM and analog sensors.

Version Part no.	Process 1-ch 30 026 633
	Analog
	ISM
pH/ORP	•
pH/pNa	–
UniCond2e	–
UniCond4e	–
Cond2e	•
Cond4e	•
Amp. DO ppm/ppb/trace	•/•/•*
Amp. O ₂ gas ppm/ppb/trace	•/–/–*
Optical DO	–
Dissolved Carbon Dioxide (InPro5000i)	–
CO ₂ hi (InPro5500i)	–
Turbidity	• (backscatter)

* INGOLD sensors

A colored touch screen conveys measuring data and setup information. The menu structure allows the operator to modify all operational parameters by using the touch screen. A menu-lock-out feature, with password protection, is available to prevent the unauthorized use of the meter. The M800 Multi-parameter transmitter can be configured to use up to eight analog and/or up to eight relay outputs for process control.

The M800 Multi-parameter transmitter is equipped with a USB communication interface. This interface provides up- and download capabilities of the transmitter configuration via a Personal Computer (PC).

This description corresponds to the firmware release, version 1.2. Changes are taking place constantly, without prior notification.

2 Safety instructions

This manual includes safety information with the following designations and formats.

2.1 Definition of equipment and documentation symbols and designations



WARNING: POTENTIAL FOR PERSONAL INJURY.



CAUTION: Possible instrument damage or malfunction.



NOTE: Important operating information.



On the transmitter or in this manual text indicates: Caution and/or other possible hazard including risk of electric shock (refer to accompanying documents).

The following is a list of general safety instructions and warnings. Failure to adhere to these instructions can result in damage to the equipment and/or personal injury to the operator.

- The M800 Transmitter should be installed and operated only by personnel familiar with the transmitter and who are qualified for such work.
- The M800 Transmitter must only be operated under the specified operating conditions (see chapter 15 “Specifications”).
- Repair of the M800 Transmitter must be performed by authorized, trained personnel only.
- With the exception of routine maintenance, cleaning procedures, as described in this manual, the M800 Transmitter must not be tampered with or altered in any manner.
- Mettler-Toledo accepts no responsibility for damage caused by unauthorized modifications to the transmitter.
- Follow all warnings, cautions, and instructions indicated on and supplied with this product.
- Install equipment as specified in this instruction manual. Follow appropriate local and national codes.
- Protective covers must be in place at all times during normal operation.
- If this equipment is used in a manner not specified by the manufacturer, the protection provided by it against hazards may be void.



WARNINGS:

- Installation of cable connections and servicing of this product require access to shock hazard voltage levels.
- Main power and relay contacts wired to a separate power source must be disconnected before servicing.
- Switch or circuit breaker shall be in close proximity to the equipment and within easy reach of the OPERATOR; it shall be marked as the disconnecting device for the equipment.
- Main power must employ a switch or circuit breaker as the disconnecting device for the equipment.
- Electrical installation must be in accordance with the National Electrical Code and/or any other applicable national or local codes.

**NOTE: RELAY CONTROL ACTION**

the M800 Transmitter relays will always de-energize on loss of power, equivalent to normal state, regardless of relay state setting for powered operation. Configure any control system using these relays with fail-safe logic accordingly.

**NOTE: PROCESS UPSETS**

Because process and safety conditions may depend on consistent operation of this transmitter, provide appropriate means to maintain operation during sensor cleaning, replacement, or sensor or instrument calibration.



NOTE: This is a 4-wire-product with an active 4–20 mA analog output.

Please do not supply power to terminal 3 to 10 of TB1 and terminal 1 to 8 of TB3.

2.2 Correct disposal of the unit

When the transmitter is finally removed from service, observe all local environmental regulations for proper disposal.

3 Unit overview

The M800 models are available in 1/2 DIN case size. The M800 models provide an integral IP66 housing for wall- or pipe mount.

3.1 Overview

3.1.1 1-Channel Version

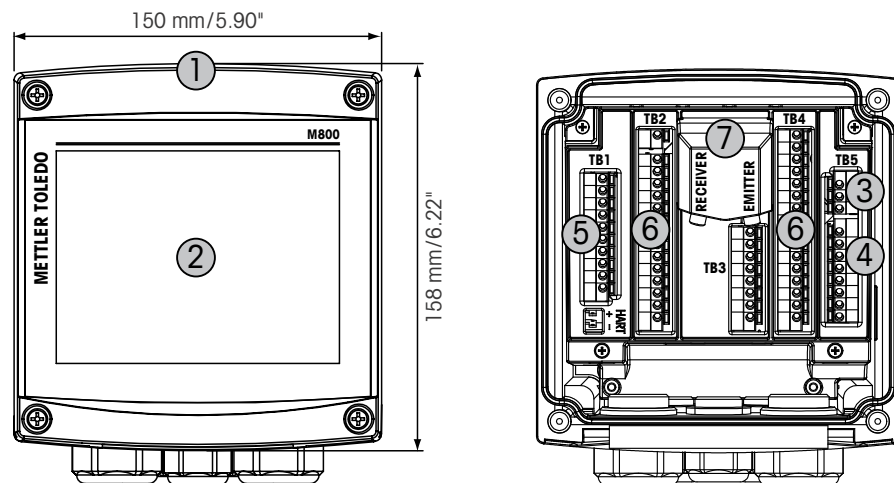

- 1: Hard Polycarbonate case
- 2: VGA Screen
- 3: Power Supply Terminals
- 4: Relay Output Terminals
- 5: Analog Output/Digital Input Terminals
- 6: Sensor Input Terminals
- 7: Connection Turbidity Sensor (InPro8000 Series)

3.1.2 2-Channel and 4-Channel Version

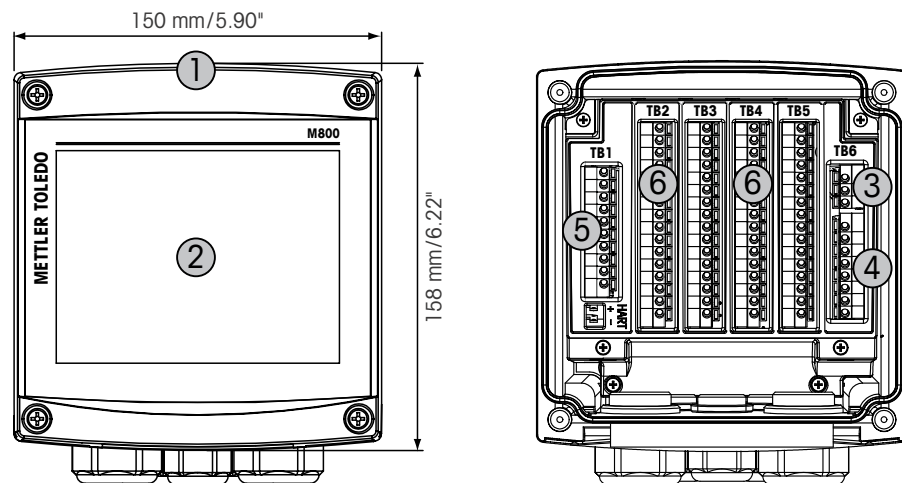

- 1: Hard Polycarbonate case
- 2: VGA Screen
- 3: Power Supply Terminals
- 4: Relay Output Terminals
- 5: Analog Output/Digital Input Terminals
- 6: Sensor Input Terminals

3.2 Display

3.2.1 Start Screen

After starting the M800, the following Start Screen (logout screen) is shown automatically. To return from the Menu Screen to the Start Screen press . The M800 will return automatically after 240 seconds from the Menu Screen or any configuration screen to the Start Screen if the user has not pressed the touch screen.

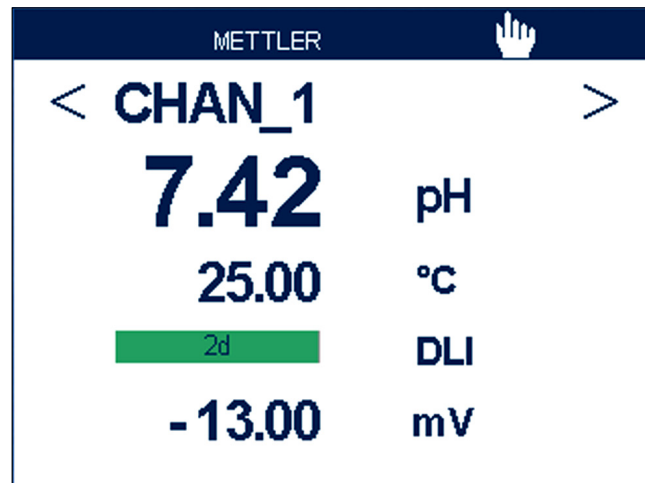

3.2.2 Activation Menu Screen

While the M800 shows the Start Screen (logout screen) touch the display to activate the Menu Screen. To return to the Menu Screen from other menus press .

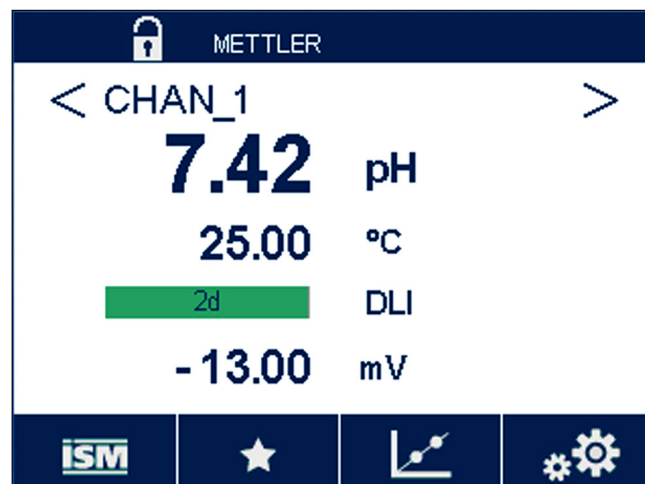

3.3 Graphic Trend Measurement

Any single measurement may be displayed as a trend measurement over time. Measurement values will be indicated by a value on the Y-axis and time elapsed on the X-axis of the graph displayed. An actual measurement for the selected value will also be displayed numerically above the graphic trend display. The measurement value is refreshed once per second.

Graphic trending will only display the data within maximum/minimum range. Out of range values or invalid values will not be displayed. The Y-axis will display the maximum value unit with its range; X-axis unit uses "mins" for minutes for measurements less than one hour and "hrs" for one day. 4 scales for X/Y-axis. The maximum value on Y-axis is one decimal place.

3.3.1 Activation Trend Display Screen

While the M800 displays the Menu Screen, touch any measurement value line of the display screen twice (1-chan, 2-chan, 4-meas, 8-meas) to activate the trend display for that measurement.

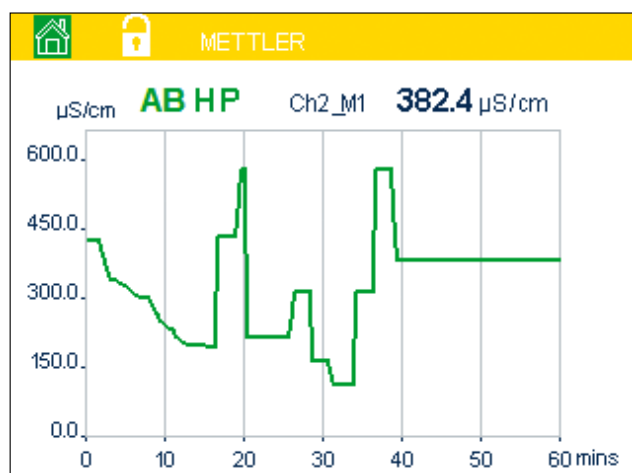

If a sensor is disconnected/connected a pop-up window come up; after closing the window, it will go back to the Menu Screen.

Red/yellow bar on top line will display for any message occurring during trending. 'H', 'P', "AB" will display when this channel is in hold or process.

3.3.2 Settings for Trend Display Screen

For setting configurations, touch any area of the graphic trend display to go to the pop-up window of this measurement parameter. Settings are at the default values. However, these settings may be changed when options are available, as needed.

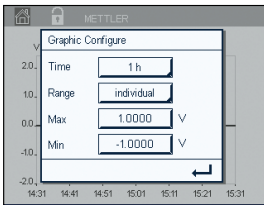

Time: Option button. For graphic display time (X-axis)
 1-h (default value)
 1-day

NOTE: 1 h means: 1 meas storage/15 seconds, totally 240 measurements for 1h. 1 day means: 1 meas storage/6 minutes, totally 240 measurements for 1 day;

Range: Option button
 Default(default value)
 Individual

When "Default" modes are set for the maximum or minimum value, this indicates the full measurement range for this unit. A Max or Min button is not displayed. If setting is selectable, the user can set maximum and minimum settings manually.

Max: Edit button.
 Maximum value of this unit on Y-axis. xxxxxx, floating decimal point.

Min: Edit button.
 Minimum value of this unit on Y-axis. xxxxxx, floating decimal point.
 Max Value > Min Value



NOTE: Settings for Y-and Y-axis and the corresponding measurement values are stored the transmitters memory. A power down returns to default settings.

3.3.3 Deactivation Trend Display Screen

Press  in activated graphic trend screen to return to Menu Screen.



NOTE: If a sensor is disconnected/connected a pop-up window come up; after closing the window, it will go back to the Menu Screen.

3.4 Control/Navigation

3.4.1 Menu Structure

Below is the structure of the M800 menu tree:

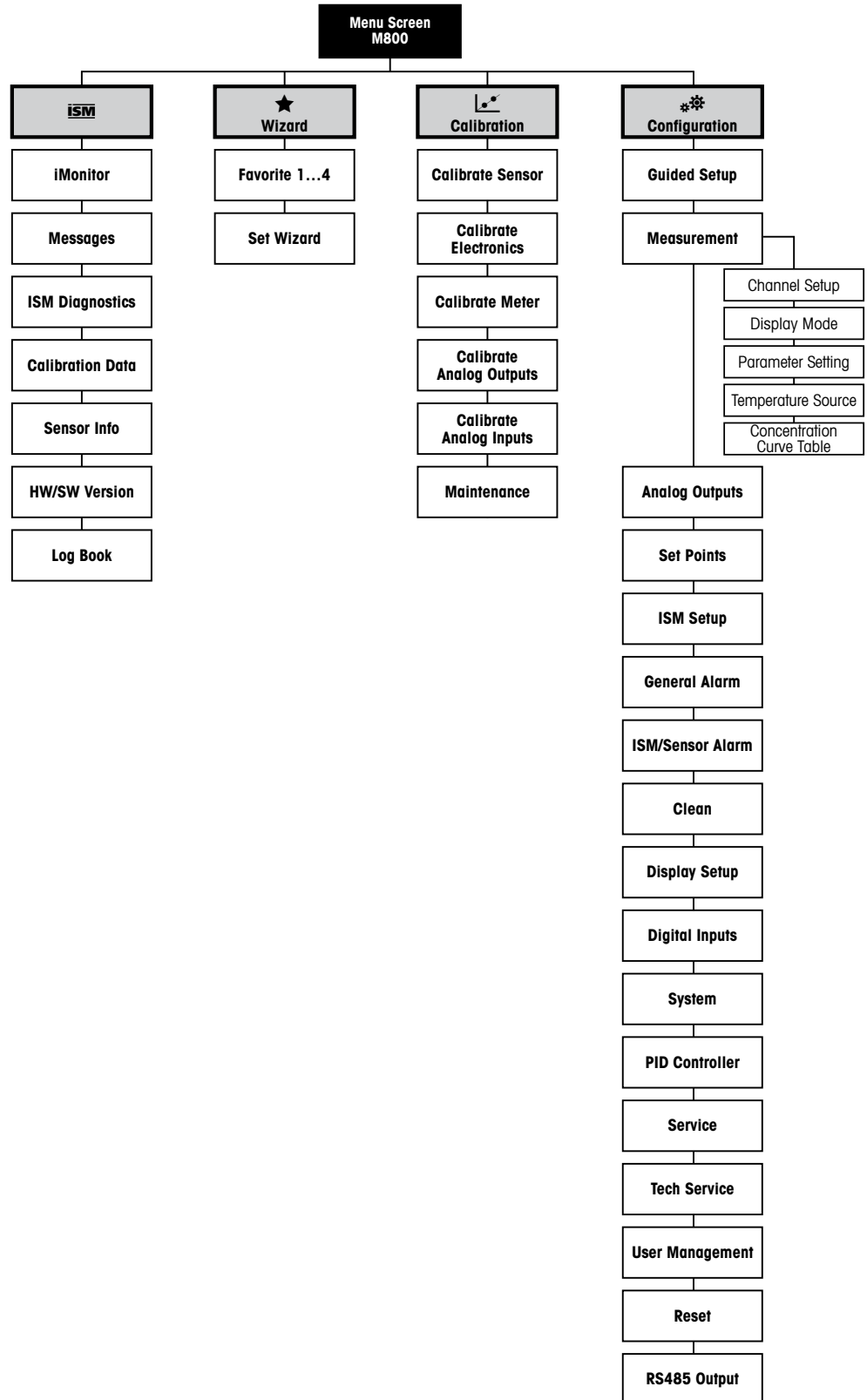

3.4.2 Navigation

3.4.2.1 Enter the Main Menus

Activate the Menu Screen and press one of icons to enter the different main menus:



ISM menu



Wizard menu

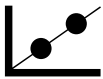

Calibration menu



Configuration menu

3.4.2.2 Navigating the Menu Tree

To browse through the menus, press the open arrows > and/or <. To access a menu touch the corresponding arrow ► in the same line.

3.4.2.3 Exit a Menu

Press ⏪ to exit the menu. Press 🏠 to return to the Menu Screen (see chapter 3.2.2 "Activation Menu Screen").

3.4.2.4 Confirm Data and Values

Use the ↵ key to confirm values. Press ESC and the values will not be stored.

3.4.2.5 Return to the Menu Screen

Press 🏠 to return to the Menu Screen (see chapter 3.2.2 "Activation Menu Screen"). To return from the Menu Screen to the Start Screen press 🔒.

3.4.3 Entry of Data

The M800 displays a keypad for modifying values. Press the ↵ button and the transmitter will store the value. Press the ESC button to exit the keypad without changing data.



NOTE: For some values, the units can be modified. In this case the keypad shows a button with a U. To select another unit for the entered value on the keypad press the U button. To return again press the 0–9 button.



NOTE: For some entries letters and/or numbers can be used. In this case the keypad shows a button 'A,a,0'. Press this button to change between capital letters, small letters and numbers on the keypad.

3.4.4 Selection Menus

Some menus require a selection of a parameter / data. In this case the transmitter displays a pop up window. Press the according field to select the value. The pop-up window will be closed and the selection will be stored.

3.4.5 "Save changes" Dialog

If the M800 brings up the "Save changes" dialog there are the following options. No will discard the entered values, Yes will save changes made and Cancel will bring you back to continue configuring.

3.4.6 Security Passwords

The M800 Transmitter allows a security lock-out of various menus. If the security lock-out feature of the transmitter has been enabled, a security password must be entered to allow access to the menu. See chapter 8.15 "User Management".

3.4.7 Display



NOTE: In the event of an alarm or other error conditions the M800 Transmitter will display a flashing bar graph on the display. This bar graph will remain until the condition that caused it has been cleared (see chapter 13.5 "Warning- and Alarm Indication").



NOTE: During calibrations, clean, Digital In with Analog Output/Relay/USB in HOLD state, a flashing "H" (HOLD) will appear in the upper right corner of the display for the corresponding channel. This symbol will remain for 20 sec., after end of calibration. This symbol will remain for 20 seconds until after the calibration or clean is completed. This symbol will also disappear when Digital In is deactivated.

4 Installation instruction

4.1 Unpacking and inspection of equipment

Inspect the shipping container. If it is damaged, contact the shipper immediately for instructions. Do not discard the box.

If there is no apparent damage, unpack the container. Be sure all items shown on the packing list are present.

If items are missing, notify Mettler-Toledo immediately.

4.1.1 Panel cutout dimensional information

Below are cut-out dimensions required by the transmitter when mounted within a flat panel or on a flat enclosure door. This surface must be flat and smooth. Textured or rough surfaces are not recommended and may limit the effectiveness of the gasket seal provided.

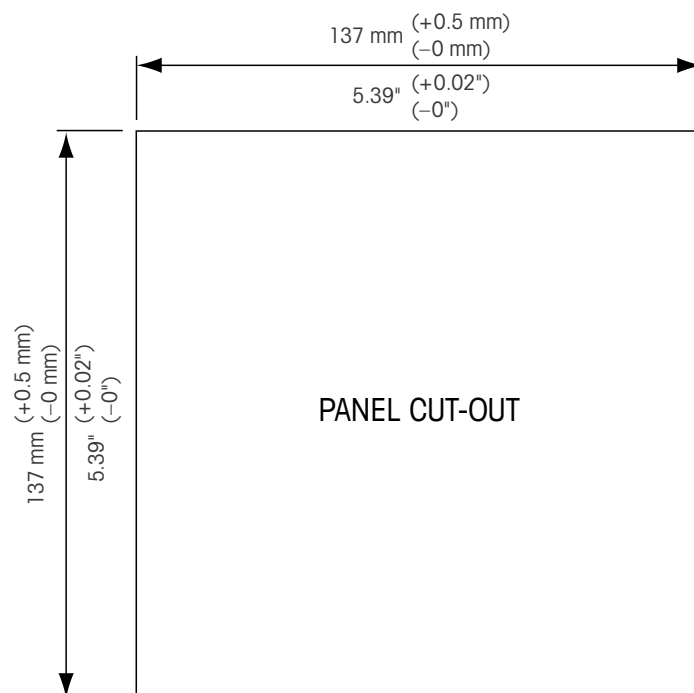

Optional hardware accessories are available that allow for panel- or pipe-mount.

Refer to chapter 14 "Accessories and Spare Parts" for ordering information.

4.1.2 Installation procedure

General:

- Orient the transmitter so that the cable grips face downward.
- Wiring routed through the cable grips shall be suitable for use in wet locations.
- In order to provide IP66 enclosure ratings, all cable glands or cable gland hole seals provided must be in place. Each cable gland must be filled using a UL rated cable marked "wet", "wet location" or "outdoor", measuring 0,36" (6.6 mm) or larger diameter, employed within the specified strain relief clamping range. Do not use metal conduit.
- Tighten the screws of the front panel with a tightening torque of 2 Nm.

For Pipe Mount:

- Use only manufacturer-supplied components for pipe-mounting the M800 Transmitter and install per the supplied instructions. See chapter 14 "Accessories and Spare Parts" for ordering information.
- Tighten the fixing screws with a tightening torque of 2 to 3 Nm.

4.1.3 Assembly

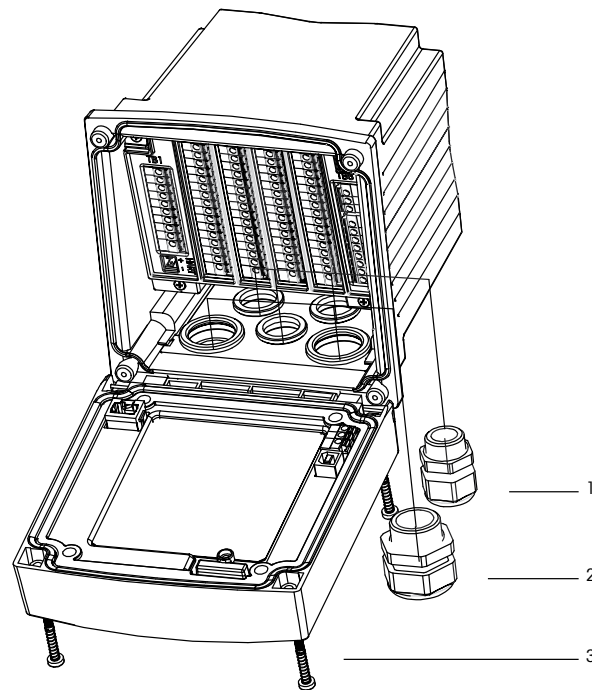

- 1: 3 M20x1.5 cable glands
 2: 2 M25x1.5 cable glands
 3: 4 screws

4.1.4 Dimension drawings

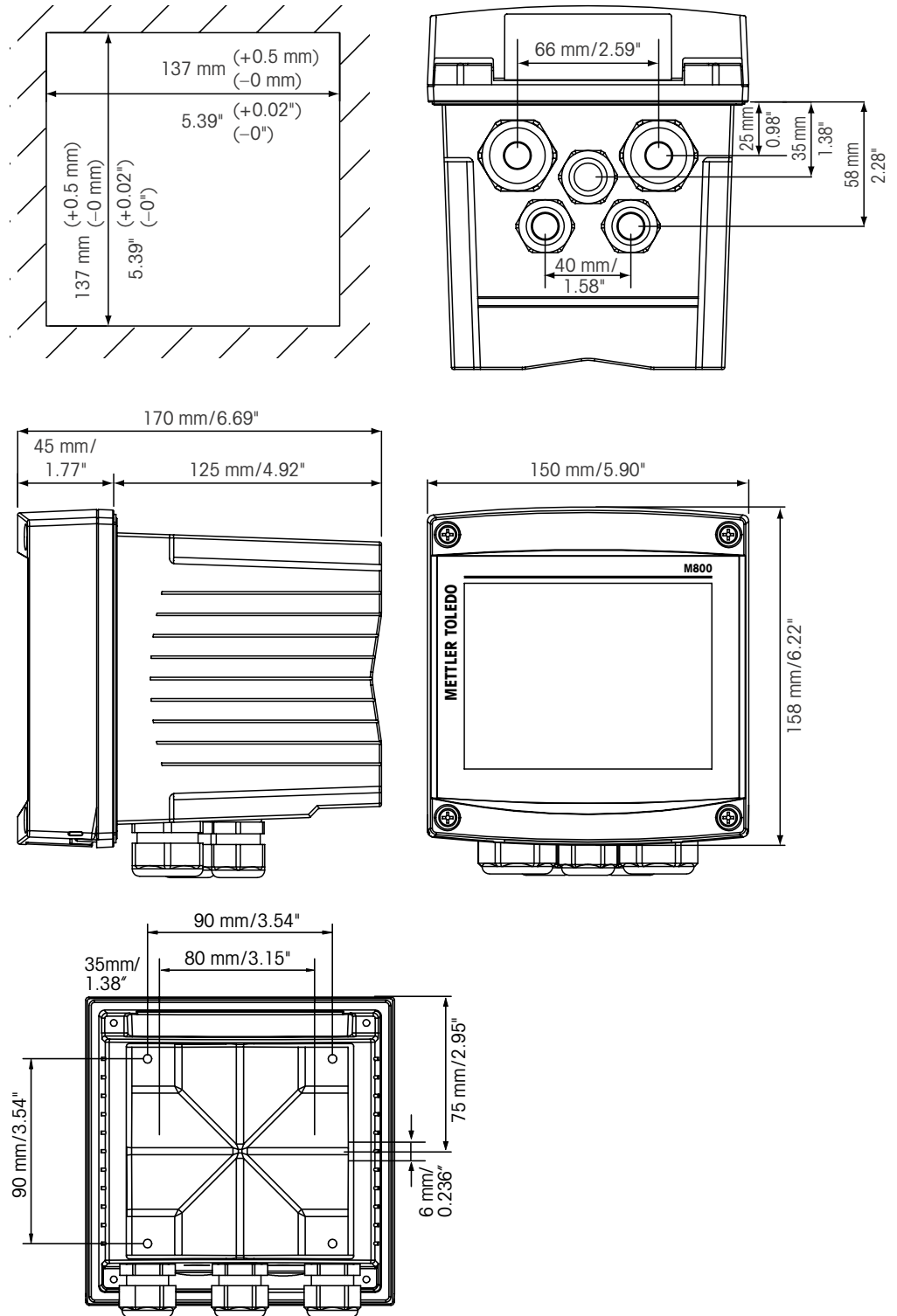

4.1.5 Pipe mounting

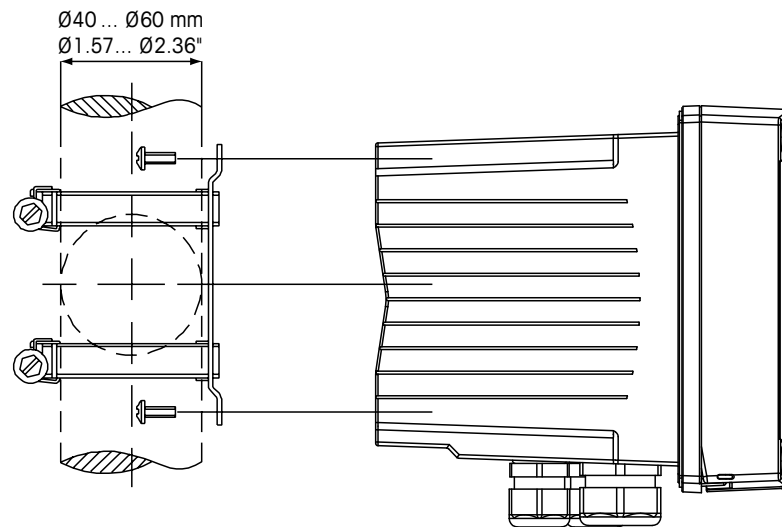

4.2 Connection of power supply

All connections to the transmitter are made on the inside of all models.



Be sure power to all wires is turned off before proceeding with the installation.

All M800 models are designed to operate from a 20–30 VDC or a 100 to 240 VAC power source. Refer to specifications for power requirements and ratings and size power wiring accordingly (16–24 AWG, wire cross-section between 0.2 mm² and 1.5 mm²).

Connect power source for 1-channel versions to terminal TB5. Connect power source for 2-channel or 4-channel versions to terminal TB6.

One terminal is labeled **N** (–) for the Neutral wire and the other **L** (+) for the Line (or Load) wire. For DC power, use the polarity shown in parentheses.

The terminals are suitable for single wires and flexible leads with a wire cross-section from 0.2 mm² up to 1.5 mm², (16–24 AWG).

4.3 Terminal Definition

4.3.1 M800 1-channel

Power connections:

N (-) for Neutral and **L(+)** for Line for 20 to 30 VDC. **N** for Neutral and **L** for Line for 100 to 240 VAC.

Terminal number	TB1	TB2	TB3	TB4	TB5
					L (+)
					N (-)
					Ground
1	DI1+	For analog sensors sensor-specific.	1-Wire	AI1+	Relay1_NC
2	DI1-		GND5V	AI1-	Relay1_COM
3	Aout1+		RS485B	DI4+	Relay2_NO
4	Aout1-		RS485A	DI4-	Relay2_COM
5	Aout2+	For ISM sensors not used.	GND5V	DI5+	Relay3_NO
6	Aout2-		5V	DI5-	Relay3_COM
7	Aout3+		24V	DI6+	Relay4_NO
8	Aout3-		GND24V	DI6-	Relay4_COM
9	Aout4+		n. a.	Relay5_NO	n. a.
10	Aout4-		n. a.	Relay5_COM	n. a.
11	n. a.		n. a.	Relay6_NO	n. a.
12	n. a.		n. a.	Relay6_COM	n. a.
13	n. a.		n. a.	Relay7_NO	n. a.
14	n. a.		n. a.	Relay7_COM	n. a.
15	n. a.		n. a.	Relay8_NC	n. a.
16	n. a.		n. a.	Relay8_COM	n. a.

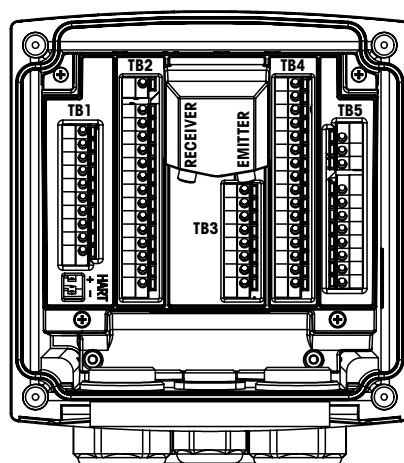

NO: normally open (contact open if un-actuated).
 NC: normally closed (contact closed if un-actuated).
 n.a. not available



NOTE: This is a 4-wire-product with an active 4–20 mA analog output. Please do not supply power to terminal no. 3 to 10 of TB1.

4.3.1.1 InPro8000 Series Turbidity Sensor

Use the two connections labeled EMITTER and RECEIVER for connecting METTLER TOLEDO InPro8000 sensors only. Patch cords are available up to 170 m (558 ft) in length. Mismatching the two ends of a sensor cable is not possible. Only hand-screwed fixing of the two SMA connectors of the sensor cable on the transmitter connectors is recommended.



CAUTION: Do not cut or shorten fiber optic cables. Cutting of fiber optic cables and assembly of SMA connectors require special tools. Where it is desired to use shorter patch cables, consult your METTLER TOLEDO supplier.

See the appropriate sensor instruction manual for detailed information regarding installation and specific use of fiber optic sensors.

4.3.2 M800 2-channel

Power connections:

N (-) for Neutral and **L (+)** for Line for 20 to 30 VDC. **N** for Neutral and **L** for Line for 100 to 240 VAC.

Terminal number	TB1	TB2 (ISM Ch1,2)	TB3	TB4	TB5	TB6
				Not installed		L (+)
						N (-)
						Ground
1	DI1+	DI2+	Aout5+		AI1+	Relay1_NC
2	DI1-	DI2-	Aout5-		AI1-	Relay1_COM
3	Aout1+	1-Wire_Ch1	Aout6+		DI4+	Relay2_NO
4	Aout1-	GND5V_Ch1	Aout6-		DI4-	Relay2_COM
5	Aout2+	RS485B_Ch1	Aout7+		DI5+	Relay3_NO
6	Aout2-	RS485A_Ch1	Aout7-		DI5-	Relay3_COM
7	Aout3+	GND5V_Ch1	Aout8+		DI6+	Relay4_NO
8	Aout3-	5V_Ch1	Aout8-		DI6-	Relay4_COM
9	Aout4+	24V_Ch2	Ain_Ch3		Relay5_NO	n. a.
10	Aout4-	GND24V_Ch2	AJ_Ch3		Relay5_COM	n. a.
11	n. a.	1-Wire_Ch2	5V_Ch3		Relay6_NO	n. a.
12	n. a.	GND5V_Ch2	GND5V_Ch3		Relay6_COM	n. a.
13	n. a.	RS485B_Ch2	Bin_Ch4		Relay7_NO	n. a.
14	n. a.	RS485A_Ch2	BJ_Ch4	Relay7_COM	n. a.	
15	n. a.	GND5V_Ch2	5V_Ch4	Relay8_NO	n. a.	
16	n. a.	5V_Ch2	GND5V_Ch4	Relay8_COM	n. a.	

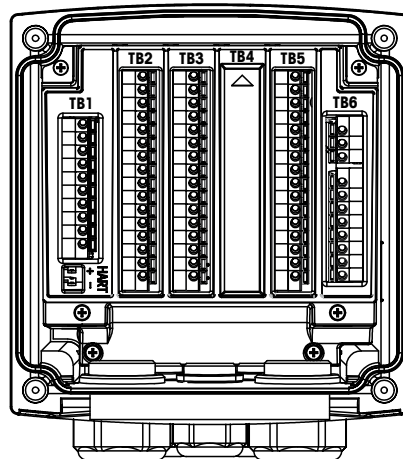

NO: normally open (contact open if un-actuated).
 NC: normally closed (contact closed if un-actuated).
 n.a. not available



NOTE: This is a 4-wire-product with an active 4–20 mA analog output.
 Please do not supply power to terminal no. 3 to 10 of TB1 and 1 to 8 of TB3.

4.3.3 M800 4-channel

Power connections:

N (-) for Neutral and **L (+)** for Line for 20 to 30 VDC. **N** for Neutral and **L** for Line for 100 to 240 VAC.

Terminal number	TB1	TB2 (ISM Ch1,2)	TB3	TB4 (ISM Ch3,4)	TB5	TB6
						L (+)
						N (-)
						Ground
1	DI1+	DI2+	Aout5+	DI3+	AI1+	Relay1_NC
2	DI1-	DI2-	Aout5-	DI3-	AI1-	Relay1_COM
3	Aout1+	1-Wire_Ch1	Aout6+	1-Wire_Ch3	DI4+	Relay2_NO
4	Aout1-	GND5V_Ch1	Aout6-	GND5V_Ch3	DI4-	Relay2_COM
5	Aout2+	RS485B_Ch1	Aout7+	RS485B_Ch3	DI5+	Relay3_NO
6	Aout2-	RS485A_Ch1	Aout7-	RS485A_Ch3	DI5-	Relay3_COM
7	Aout3+	GND5V_Ch1	Aout8+	GND5V_Ch3	DI6+	Relay4_NO
8	Aout3-	5V_Ch1	Aout8-	5V_Ch3	DI6-	Relay4_COM
9	Aout4+	24V_Ch2	Ain_Ch5	24V_Ch4	Relay5_NO	n. a.
10	Aout4-	GND24V_Ch2	AJ_Ch5	GND24V_Ch4	Relay5_COM	n. a.
11	n. a.	1-Wire_Ch2	5V_Ch5	1-Wire_Ch4	Relay6_NO	n. a.
12	n. a.	GND5V_Ch2	GND5V_Ch5	GND5V_Ch4	Relay6_COM	n. a.
13	n. a.	RS485B_Ch2	Bin_Ch6	RS485B_Ch4	Relay7_NO	n. a.
14	n. a.	RS485A_Ch2	BJ_Ch6	RS485A_Ch4	Relay7_COM	n. a.
15	n. a.	GND5V_Ch2	5V_Ch6	GND5V_Ch4	Relay8_NC	n. a.
16	n. a.	5V_Ch2	GND5V_Ch6	5V_Ch4	Relay8_COM	n. a.

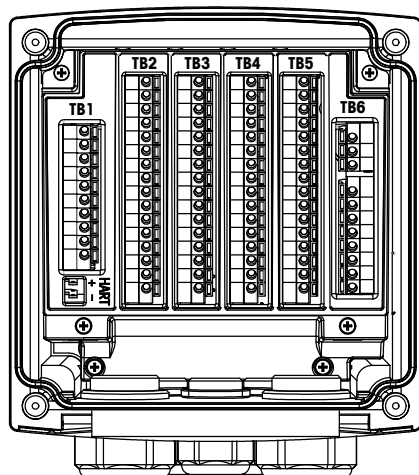

NO: normally open (contact open if un-actuated).

NC: normally closed (contact closed if un-actuated).

n.a. not available



NOTE: This is a 4-wire-product with an active 4–20 mA analog output.

Please do not supply power to terminal no. 3 to 10 of TB1 and 1 to 8 of TB3.

4.3.4 M800 1-channel: TB2 – Conductivity 2e/4e Analog Sensors

Cond 4-E or 2-E		
Terminal	Function	Color
1	Cnd inner1 ¹⁾	white
2	Not used	–
3	Cnd outer1 ¹⁾	white/blue
4	Cnd outer1	–
5	Not used	–
6	Cnd outer2	–
7	Cnd inner2 ²⁾	blue
8	Cnd outer2 (GND) ²⁾	black
9	Not used	–
10	Not used	–
11	Not used	–
12	RTD ret/GND	bare shield
13	RTD sense	red
14	RTD	green
15	Not used	–
16	5V output	–

1) For third party Cond 2e sensors a jumper between 1 and 3 may be required.

2) For third party Cond 2e sensors a jumper between 7 and 8 may be required.

4.3.5 M800 1-channel: TB2 – pH/ORP Analog Sensors

Terminal	pH		Redox (ORP)	
	Function	Color 1 ¹⁾	Function	Color
1	Glass	transparent	Platinum	transparent
2	Not used	–	–	–
3	Not used	–	–	–
4	Not used	–	–	–
5	Not used	–	–	–
6	Reference	red	Reference	red
7	Reference ²⁾	–	Reference ²⁾	–
8	Solution GND ²⁾	blue ³⁾	Solution GND ²⁾	–
9	Not used	–		
10	Shield (GND)	green/yellow	Shield (GND)	green/yellow
11	Not used	–	–	–
12	RTD ret/GND	white	–	–
13	RTD sense	–	–	–
14	RTD	green		
15	Not used	–	–	–
16	5 V output	–	–	–

1) Grey wire not used.

2) Install jumper between 7 and 8 for ORP sensors and pH electrodes without SG.

3) Blue wire for electrode with SG.

4.3.6 M800 1-channel: TB2 – Oxygen Analog Sensors

		InPro6800	InPro6900	InPro6950
Terminal	Function	Color	Color	Color
1	Not used	–	–	–
2	Not used	–	–	–
3	Anode	red	red	red
4	Anode	– 1)	– 1)	–
5	Reference	– 1)	– 1)	blue
6	Not used	–	–	–
7	Not used	–	–	–
8	Guard	–	grey	grey
9	Cathode	transparent	transparent	transparent
10	Shield (GND)	green/yellow	green/yellow	green/yellow
11	Not used	–	–	–
12	NTC ref (GND)	white	white	white
13	Not used	–	–	–
14	NTC	green	green	green
15	Not used	–	–	–
16	5 V output	–	–	–

1) Install jumper between 4 and 5 for InPro6800 and InPro6900.

4.3.7 M800 2- and 4-channel: TB2 and TB4 – Terminal Assignment for Optical Oxygen, CO₂ hi, UniCond2e, UniCond4e and 500TOCi ISM Sensors

	TB2 (ISM Ch1,2)	TB4 (ISM Ch3,4)	Optical Oxygen ¹⁾, CO₂ hi ¹⁾		UniCond2e ²⁾, UniCond4e ²⁾, 500TOCi
Terminal	Function	Function	VP8 cables wire color	5-pin cables wire color	Cables wire color
1	DI2+	DI6+	–	–	–
2	DI2–	DI6–	–	–	–
3	1-Wire_Ch1	1-Wire_Ch3	–	–	–
4	GND5V_Ch1	GND5V_Ch3	–	–	–
5	RS485B_Ch1	RS485B_Ch3	–	–	black
6	RS485A_Ch1	RS485A_Ch3	–	–	red
7	GND5V_Ch1	GND5V_Ch3	–	–	white
8	5V_Ch1	5V_Ch3	–	–	blue
9	24V_Ch2	24V_Ch4	grey	brown	–
10	GND24V_Ch2	GND24V_Ch4	blue	black	–
11	1-Wire_Ch2	1-Wire_Ch4	–	–	–
12	GND5V_Ch2	GND5V_Ch4	green/yellow	grey	–
13	RS485B_Ch2	RS485B_Ch4	brown	blue	black
14	RS485A_Ch2	RS485A_Ch4	pink	white	red
15	GND5V_Ch2	GND5V_Ch4	–	yellow	white
16	5V_Ch2	5V_Ch4	–	–	blue

1) One O₂ optical or thermal conductivity CO₂ sensor can be connected to plug TB2 and TB4.

2) Transparent wire not connected.

4.3.8 M800 2- and 4-channel: TB2 and TB4 – Terminal Assignment for pH, Amp. Oxygen, Cond 4e, CO₂ and O₃ ISM Sensors

	TB2 (ISM Ch1,2)	TB4 (ISM Ch3,4)	pH, Amp. Oxygen, Cond 4e, CO₂ and O₃
Terminal	Function	Function	Cables wire color
1	DI2+	DI6+	–
2	DI2–	DI6–	–
3	1-Wire_Ch1	1-Wire_Ch3	transparent (cable core)
4	GND5V_Ch1	GND5V_Ch3	red
5	RS485B_Ch1	RS485B_Ch3	–
6	RS485A_Ch1	RS485A_Ch3	–
7	GND5V_Ch1	GND5V_Ch3	–
8	5V_Ch1	5V_Ch3	–
9	24V	24V	–
10	GND24V	GND24V	–
11	1-Wire_Ch2	1-Wire_Ch4	transparent (cable core)
12	GND5V_Ch2	GND5V_Ch4	red
13	RS485B_Ch2	RS485B_Ch4	–
14	RS485A_Ch2	RS485A_Ch4	–
15	GND5V_Ch2	GND5V_Ch4	–
16	5V_Ch2	5V_Ch4	–

4.3.9 M800 1-channel: TB3 – Terminal Assignment for Optical Oxygen, CO₂ hi, UniCond2e and UniCond4e ISM Sensors

	TB3	Optical Oxygen, CO₂ hi		UniCond2e ¹⁾, UniCond4e ¹⁾
Terminal	Function	VP8 cables wire color	5-pin cables wire color	Cables wire color
1	1-Wire	–	–	–
2	GND5V	–	yellow	–
3	RS485B	brown	blue	black
4	RS485A	pink	white	red
5	GND5V	green/yellow	grey	white
6	5V	–	–	blue
7	24V	grey	brown	–
8	GND24V	blue	black	–
9	Not used	–	–	–
10	Not used	–	–	–
11	Not used	–	–	–
12	Not used	–	–	–
13	Not used	–	–	–
14	Not used	–	–	–
15	Not used	–	–	–
16	Not used	–	–	–

1) Transparent wire not connected.

4.3.10 M800 1-channel: TB3 – Terminal Assignment for pH and Turbidity ISM Sensors

	TB3	pH, Amp. Oxygen, CO₂ and Cond 4e	Turbidity (InPro8600i/D1, InPro8600i/D3)
Terminal	Function	Cables: wire color	Cables: wire color
1	1-Wire	transparent (cable core)	
2	GND5V	red	green/yellow
3	RS485B	–	green
4	RS485A	–	yellow
5	GND5V	–	–
6	5V	–	–
7	24V	–	brown
8	GND24V	–	white
9	Not used	–	–
10	Not used	–	–
11	Not used	–	–
12	Not used	–	–
13	Not used	–	–
14	Not used	–	–
15	Not used	–	–
16	Not used	–	–

1) Transparent wire not connected.

4.3.11 M800 2- and 4-channel Water: TB3 – Terminal Assignment for Flow Sensors

	TB3	Flow hi, Flow lo, Flow Type2
Terminal	Transmitter	Function
1	Aout5+	–
2	Aout5-	–
3	Aout6+	–
4	Aout6-	–
5	Aout7+	–
6	Aout7-	–
7	Aout8+	–
8	Aout8-	–
9	Ain_Ch3 / Ain_Ch5	Flow Pulse Input
10	AJ_Ch3 / AJ_Ch5	+ 10 VDC
11	5V_Ch3 / 5V_Ch5	+ 5 VDC
12	GND5V_Ch3 / GND5V_Ch5	Ground
13	Ain_Ch4 / Ain_Ch6	Flow Pulse Input
14	AJ_Ch4 / AJ_Ch6	+ 10 VDC
15	5V_Ch4 / 5V_Ch6	+ 5 VDC
16	GND5V_Ch4 / GND5V_Ch6	Ground

4.4 Connection of Flow Sensor

The M800 Transmitter is designed to operate with various types of sensors. These sensors require different wiring configurations. Listed below are instructions for wiring the various types of sensors offered by METTLER TOLEDO Thornton for use with this transmitter. Please consult the factory for assistance if attempting to wire sensors not offered by METTLER TOLEDO Thornton as some sensors may not be compatible.

4.4.1 Flow Sensor Input Wiring Kit

This kit contains components that may be needed at input terminals to condition sensor signals. Refer to the following sections or to the instruction manual for wiring details.

4.4.2 Kit Contents

This kit contains the following items:

- 4x Wire nuts
- 4x 10K ohm resistors for use with Burket 8020 and 8030 type sensors, and GF Signet 2500-series sensors.
- 4x 1K ohm resistors for use with Data Industrial 200-series and Fluidyne insertion type sensors.
- 4x 0.33uF, 50 V capacitors for use with Berket 8020 and 8030 type sensors, Data Industrial 200-series and 4000-series sensors, GF Signet 2500-series sensors, Sanitary Turbine-Type sensors, Fluidyne insertion type sensors and Racine Federated (Formerly Asahi/America) vortex-style sensors.

4.4.3 Flow sensor wiring for Compatible Sensors

The following sections provide wiring information to properly connect various compatible flow sensors to the M800 Transmitter. When using the Configuration menu of the transmitter to setup the flow sensor, the first prompt asks to select the TYPE of flow sensor being connected.

There are three choices as follows:

- High: All flow sensors described in Section 4.4.4
- Low: P515 Signet flow sensors only, described in section 4.4.5
- Type 2: Asahi flow sensors, described in Section 4.4.6

4.4.4 Wiring for "HIGH" type flow sensors

The following wiring information is used when connecting (Burkert 8020 and 8030 type) inline Hall effect 5VDC, flow sensors. **THORNTON models 33901 thru 33935.**

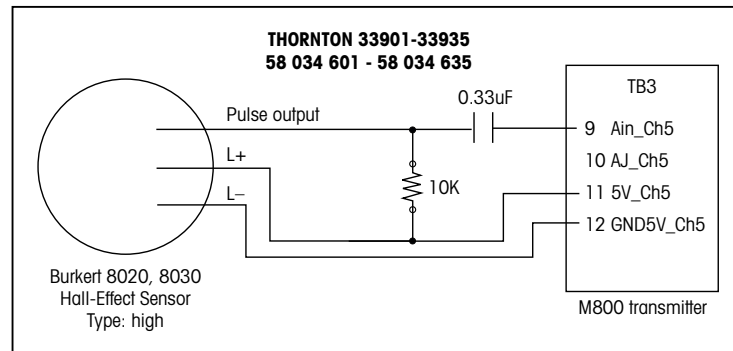

Extension cable not provided. Use 2-conductor twisted pair with shield, 22 AWG (Belden 8451 or equivalent), 1,000 ft (305 m) maximum length.

The following wiring information is used when connecting Badger (formerly Data Industrial 200-Series) forward-swept paddlewheel type flow sensors.

THORNTON models 33142 thru 33145 and 33159 thru 33162 and 33273.

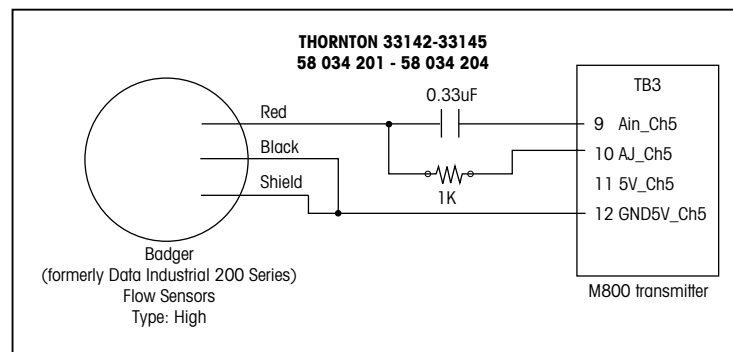

Extension cable provided with sensor. Use 2-conductor twisted pair with shield 20 AWG (Belden 9320 or equivalent) to extend length to 2000 ft (610 m) max.

The following wiring information is used when connecting Badger (formerly Data Industrial 4000-Series) forward-swept paddlewheel type flow sensors.

THORNTON models 33174 thru 33177 and 33171 and 33172.

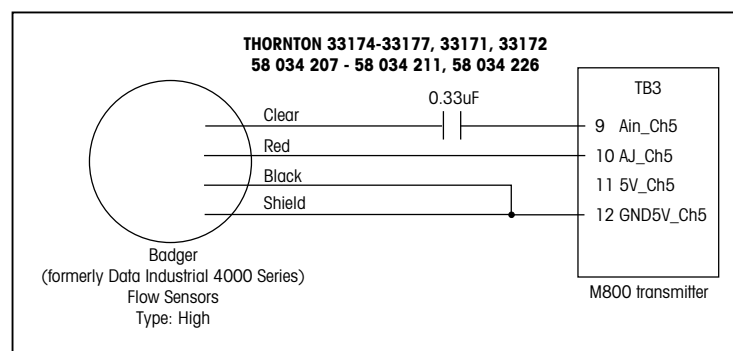

20 ft (6.1 m) extension cable provided with sensor. Use 3-conductor with shield, 20 AWG (Belden 9364 or equivalent) to extend length to 2000 ft (610 m) maximum.

The following wiring information is used when connecting (GF Signet 2500-Series) Hall Effect paddlewheel type flow sensors. **THORNTON models 33282, 33285, 33287, 33298 thru 33305.**

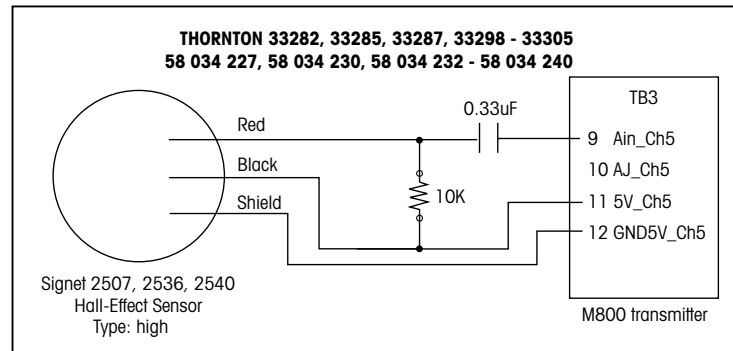

25 ft (7.6 m) extension cable provided with sensor. Use 2-conductor with shield, 22 AWG (Belden 8451 or equivalent) to extend length to 1000 ft (305 m) maximum.

The following wiring information is used when connecting Sanitary Turbine type flow sensors. **THORNTON models 33336 thru 33377 (Hoffer) and 33441 thru 33450 (Sponsler).**

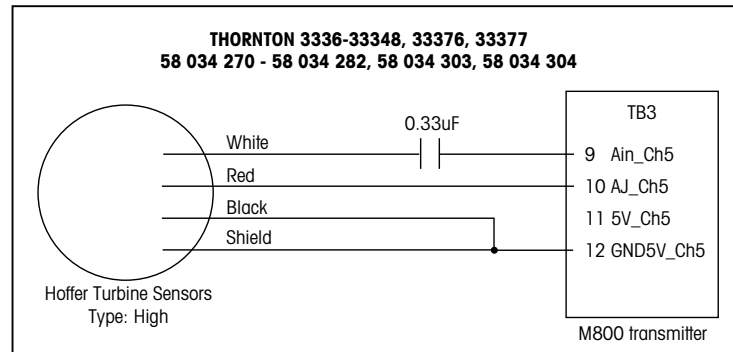

20 ft (6.1 m) extension cable provided with sensor. Use 3-conductor with shield, 20 AWG (Belden 9364 or equivalent) to extend length to 3000 ft (915 m) maximum.

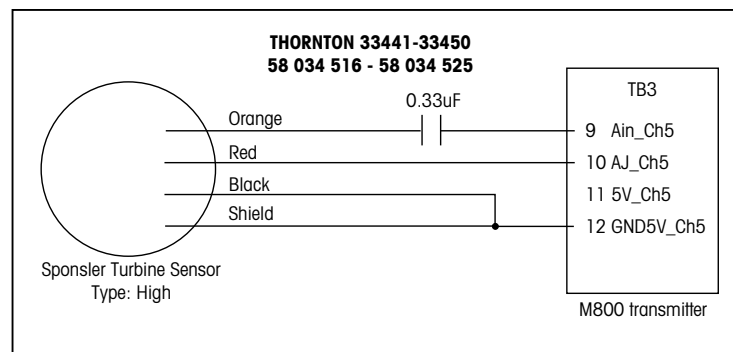

20 ft (6.1 m) extension cable provided with sensor. Use 3-conductor with shield, 20 AWG (Belden 9364 or equivalent) to extend length to 3000 ft (915 m) maximum.

The following wiring information is used when connecting Spirax Sarco/Emco flow (formerly Fluidyne) insertion type flow sensors. **THORNTON models 33358 thru 33375.**

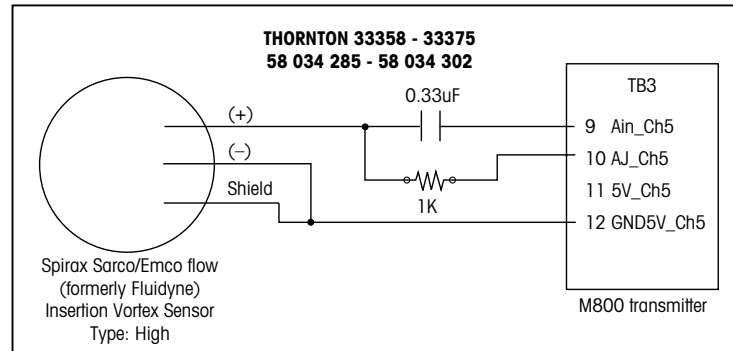

Extension cable not provided. Use 2-conductor twisted pair with shield, 20 AWG (Belden 9320 or equivalent), 2000 ft (610 m) maximum length.

4.4.5 Wiring for "LOW" type flow sensors

The following wiring information is used when connecting (GF Signet 515) type flow sensors. **THORNTON models 33189, 33193, 33195, 33196, and 33229.**

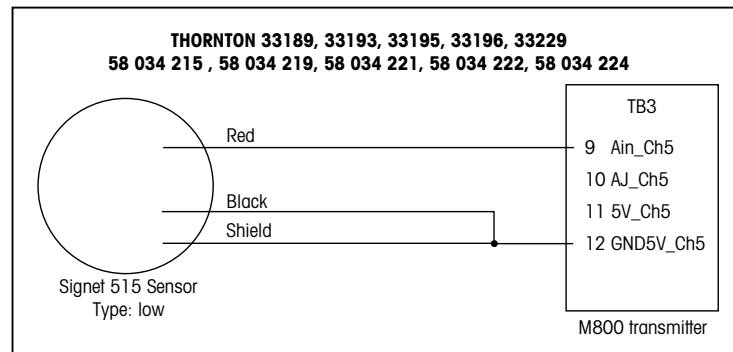

Extension cable not provided. Use 2-conductor twisted pair with shield, 22 AWG (Belden 8451 or equivalent), 200 ft (61 m) maximum length.

4.4.6 Wiring for "TYPE 2" flow sensors

The following wiring information is used when connecting Racine Federated (formerly Asahi/America) vortex flow sensors. **THORNTON models 33308 to 33335.**

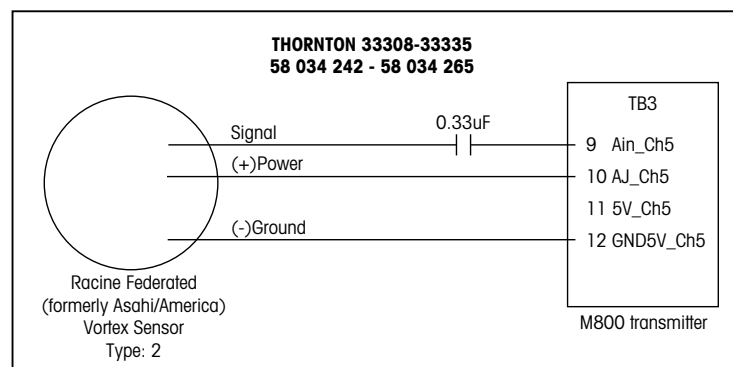

Extension cable not provided. Use 3-conductor with shield, 20 AWG (Belden 9364 or equivalent), 1000 ft (305 m) maximum length.

5 Placing transmitter in, or out, of service

5.1 Placing transmitter in service



After connecting the transmitter to power supply circuit, it will be active as soon as the circuit is powered.

5.2 Placing transmitter out of service

First disconnect the unit from the main power source, then disconnect all remaining electrical connections. Remove the unit from the panel. Use the installations instruction in this manual as reference for dis-assembling mounting hardware.

All transmitter settings stored in memory are non volatile.

6 Guided Setup

PATH:  \ CONFIG \ Guided Setup



NOTE: Please do not use Guided Setup menu after configuration of the transmitter, because some of the settings (i.e. analog output configuration) will be set to default values again.

See the following explanation to get more details about the different settings for the guided setup.

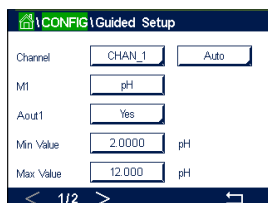

Select the desired **Channel** for the guided setup and in the same line the parameter.

If Auto is selected, M800 Transmitter automatically recognizes the type of sensor. The channel can also be fixed to a certain measurement parameter, depending on the type of transmitter. For detailed information refer to chapter 8.1.1 "Channel Setup".

Press the corresponding button to measurement **M1** to configure the measurement. For detailed information about the configuration options refer to chapter 8.1.1 "Channel Setup".



NOTE: If the guided setup for a flow sensor has been selected, the calibration factor of the sensor from the sensor label or certificate can be entered. Therefore press the Cal Factor button. For sensor types High and Low slope and offset can be entered. In case of sensor Type 2 the slope followed by a table of K and F values can be entered.

Assign the corresponding output signal **Aout'X'** to the measurement by pressing Yes. For detailed information about the configuration of the analog output signal refer to chapter 8.3 "Analog Outputs".

Enter the **Min Value**, that corresponds with start point of the analog output range.

Enter the **Max Value**, that corresponds with end point of the analog output signal.

Additional settings can be done by navigating to the next page of the menu.

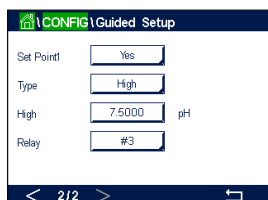

Assigning the corresponding **Set Point'X'** to the measurement by pressing Yes. For detailed information about the configuration of the set point refer to chapter 8.4 "Set Points".

Select the **Type** for the setpoint.



The type of the setpoint can be High, Low, Between, Outside or Off. An "Outside" setpoint will cause an alarm condition whenever the measurement goes above its high limit or below its low limit. A "Between" setpoint will cause an alarm condition to occur whenever the measurement is between its high and low limits.



NOTE: If the type of set point is not Off additional settings can be done. See the following description.

According to the selected type of set point, value(s) according to the limit(s) can be entered.

Select the desired relay that will be activated if the defined conditions are reached through the parameter **SP Relay**. If the chosen relay is used for another task, the transmitter shows a message on the screen that there is a Relay Conflict.

To escape the menu of the settings for Guided Setup press . To return to the Menu Screen (see chapter 3.2 "Display") press . The M800 will bring up the Save Changes dialog.

7 Calibration

For the menu structure refer to chapter 3.4.1 "Menu Structure".

PATH:  \ Cal



NOTE: During calibration, the outputs for the corresponding channel will default to be held at their current values until 20 seconds after the calibration menu is exited. A flashing H appears in the upper right corner of the display while outputs are held. Refer to chapter 8.3 "Analog Outputs" and chapter 8.4 "Set Points" to change the HOLD output status.



NOTE: ISM sensors: "Adjust" detects deviations and readjusts the sensor. Calibration is performed and calculated values are stored in the sensor. "Calibrate" detects deviations and does not readjust the sensor. Calibration is not performed, but calculated values are stored in the sensor.

Analog sensors: "SaveCal" performs calibration. The actual values can be viewed as long as the sensor is connected.

7.1 Sensor Calibration

PATH:  \ Cal \ Calibrate Sensor

Select the desired channel (**Chan**) for calibration.

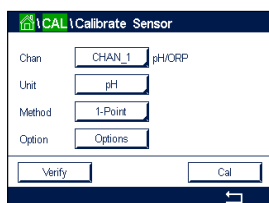

NOTE: During sensor calibration, the outputs will default their current values until 20 seconds after the calibration menu is exited. A flashing H appears in the upper right corner of the display while outputs are held. Refer to chapter 8.3 "Analog Outputs" and chapter 8.4 "Set Points" to change the HOLD output status.

See the following explanation to get more details about the calibration options and procedure.

7.2 Calibration of UniCond2e and UniCond4e Sensors (ISM Sensors only)

7.2.1 Conductivity Calibration of UniCond2e and UniCond4e Sensors

The M800 provides the ability to perform a one-point, two-point or process conductivity or resistivity calibration for 2e-sensors and 4e-sensors.



NOTE: When performing calibration on a conductivity sensor, results will vary depending on the method, calibration apparatus and/or quality of reference standards used to perform the calibration.



NOTE: For measuring tasks the temperature compensation for the application as defined through the parameter settings for conductivity will be considered and not the temperature compensation selected through the calibration procedure (see also chapter 8.1.4.1 "Conductivity Settings"; PATH: \CONFIG\Meas\Parameter Setting).

Enter the menu Calibrate Sensor (see chapter 7.1 "Sensor Calibration"; PATH: \Cal\ Calibrate Sensor) and choose the desired channel for calibration.

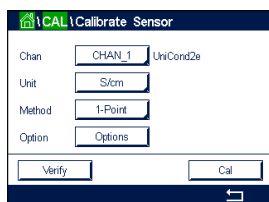

The following menus can be called up:

Unit: Choose between the units for conductivity (S/cm) and resistivity (Ω -cm).

Method: Select the desired calibration procedure. Available are 1-point, 2-point or process calibration.

Options: The desired compensation mode for the calibration process can be selected.

Choices are "None", "Standard", "Light 84", "Std 75 °C", "Linear 25°C", "Linear 20°C", "Glycol.5", "Glycol1", "Cation", "Alcohol" and "Ammonia".

None does not make any compensation of the measured conductivity value. The uncompensated value will be displayed and proceeded.

Standard compensation includes compensation for non-linear high purity effects as well as conventional neutral salt impurities and conforms to ASTM standards D1125 and D5391.

Light 84 compensation matches the high purity water research results of Dr. T.S. Light published in 1984. Use only if your institution has standardized on that work.

Std 75 °C compensation is the Standard compensation algorithm referenced to 75 °C. This compensation may be preferred when measuring Ultrapure Water at an elevated temperature (Resistivity of ultrapure water compensated to 75 °C is 2.4818 Mohm-cm.)

Linear 25 °C compensation adjusts the reading by a coefficient or factor expressed as %/°C (deviation from 25 °C). Use only if the solution has a well-characterized linear temperature coefficient. The factory default setting is 2.0%/°C. 2.4818 Mohm-cm.)

Linear 20 °C compensation adjusts the reading by a coefficient or factor expressed as %/°C (deviation from 20 °C). Use only if the solution has a well-characterized linear temperature coefficient. The factory default setting is 2.0%/°C.

Glycol.5 compensation matches the temperature characteristics of 50% ethylene glycol in water. Compensated measurements using this solution may go above 18 Mohm-cm.

Glycol1 compensation matches the temperature characteristics of 100% ethylene glycol. Compensated measurements may go well above 18 Mohm-cm.

Cation compensation is used in power industry applications measuring the sample after a cation exchanger. It takes into account the effects of temperature on the dissociation of pure water in the presence of acids.

Alcohol compensation provides for the temperature characteristics of a 75% solution of isopropyl alcohol in pure water. Compensated measurements using this solution may go above 18 Mohm-cm.

Ammonia compensation is used in power industry applications for specific conductivity measured on samples using ammonia and/or ETA (ethanolamine) water treatment. It takes into account the effects of temperature on the dissociation of pure water in the presence of these bases.



NOTE: If compensation mode "Linear 25 °C" or "Linear 20 °C" has been chosen, the coefficient for the adjustment of the reading can be modified. In this case an additional input field will be displayed.

The changes are valid until the calibration mode has been escaped. After the values defined in the configuration menu are valid again.

7.2.1.1 One-Point Calibration

Select calibration procedure 1-Point (see chapter 7.2.1 "Conductivity Calibration of UniCond2e and UniCond4e Sensors"). With 2e-sensors or 4e-sensors a one-point calibration is always performed as a slope calibration. The following procedure shows the calibration with a 2e-sensor. The calibration with a 4e-sensor works respectively.

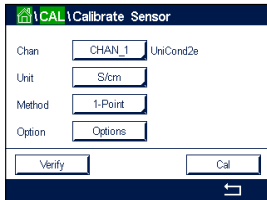

Press the button Cal for starting calibration.

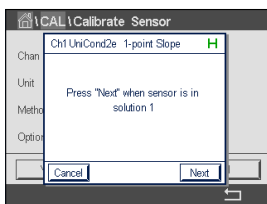

Place the electrode in the reference solution and press Next button.

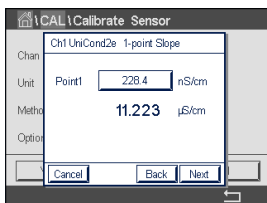

The second value displayed on the screen is the value being measured by the transmitter and sensor in units selected by the user.

Press the input field for **Point1** to enter the value for the calibration point. The M800 displays a keypad for modifying the value. Press the \leftarrow button and the transmitter will take over the value.



NOTE: To select another unit for the entered value on the keypad press the U button. To return again press the 0-9 button.

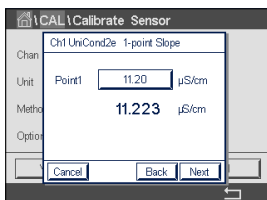

The screen shows the entered value for the reference solution (1st line) and the measured value of the M800 (2nd line).

Press the Next button to start the calculation of the calibration results.

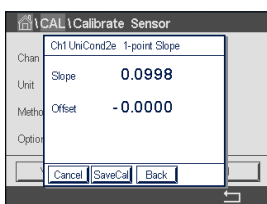

The display shows the value for the slope and the offset as the result of the calibration.

The calibration values are stored in the calibration history and taken over (press button SaveCal) or discarded (press button Cancel).

Use the Back button to go one step back in the calibration procedure.

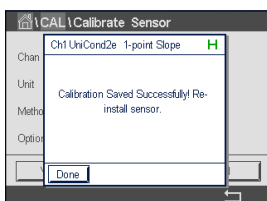

If "SaveCal" is chosen, the message "Calibration Saved Successfully!" is displayed. In either case you will see the message "Please re-install sensor". After pressing the Done button the M800 returns to the calibration menu for the sensor.

7.2.1.2 Two-Point Calibration

Select calibration procedure 2-Point. With 4e-sensors a two-point calibration is always performed as an offset and slope calibration. The following procedure shows the calibration with a 4e-sensor.

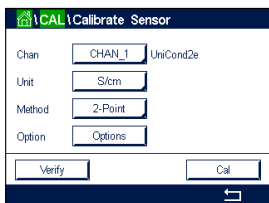

Press the button Cal for starting calibration.

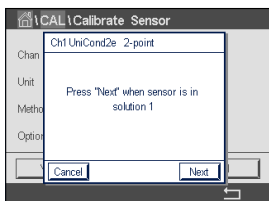

Place the electrode in the first reference solution and press Next button.

CAUTION: Rinse sensors with a high-purity water solution between calibration points to prevent contamination of the reference solutions.

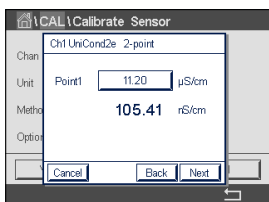

The second value displayed on the screen is the value being measured by the transmitter and sensor in the units selected by the user.

Press the input field for **Point1** to enter the calibration point. The M800 displays a keypad for modifying the value. Press the \leftarrow button to accept the value.



NOTE: To select another unit for the entered value on the keypad press the U button. To return again press the 0-9 button.

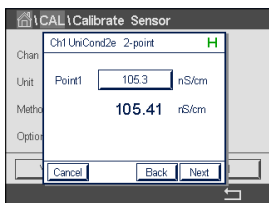

The screen shows the entered value for the first reference solution (1st line) and the measured value of the M800 (2nd line).

Press the Next button to go on with the calibration.

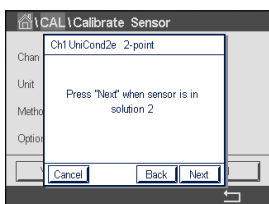

Place the electrode in the second reference solution and press Next button.

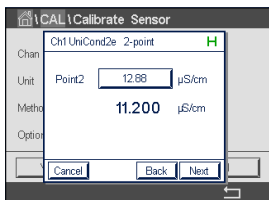

The second value displayed on the screen is the value being measured by the transmitter and sensor in the units selected by the user.

Press the input field for **Point2** to enter the calibration point. The M800 displays a keypad for modifying the value. Press the \leftarrow button to accept the value.



NOTE: To select another unit for the entered value on the keypad press the U button. To return again press the 0-9 button.

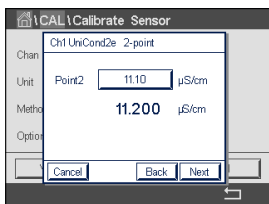

The screen shows the entered value for the second reference solution (1st line) and the measured value of the M800 (2nd line).

Press the Next button to start the calculation of the calibration results.

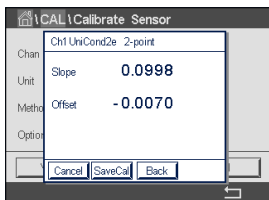

The display shows the value for the slope and the offset as the result of the calibration.

The calibration values are stored in the calibration history. To save (press button SaveCal) or to discard (press button Cancel).

Use the Back button to go one step back in the calibration procedure.

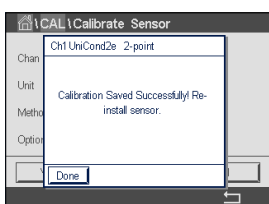

If "SaveCal" is chosen, the message "Calibration Saved Successfully!" is displayed. In either case you will see the message "Please re-install sensor". After pressing the Done button the M800 returns to the calibration menu for the sensor.

7.2.1.3 Process Calibration

Select calibration procedure Process (see chapter 7.2.1 "Conductivity Calibration of UniCond2e and UniCond4e Sensors"). With 2e-sensors or 4e-sensors a process calibration is always performed as a slope calibration. The following procedure shows the calibration with a 2e-sensor. The calibration with a 4e-sensor works respectively.

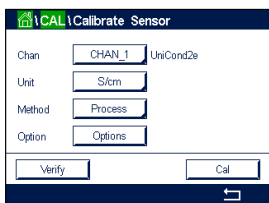

Press the button Cal for starting calibration.

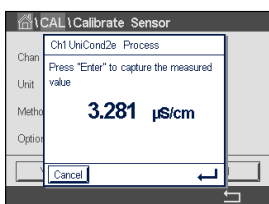

Take a sample and press the ↵ button to store the current measuring value. To show the ongoing calibration process, P is blinking in the Start and Menu screen if the related channel is selected in the display.



After determining the conductivity value of the sample, press the calibration icon in the Menu Screen (see chapter 3.4.2.1 "Enter the Main Menus") again.

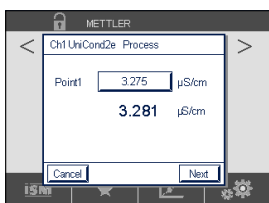

Press the input field for **Point1** and enter the conductivity value of the sample. Press the Next button to start the calculation of the calibration results.

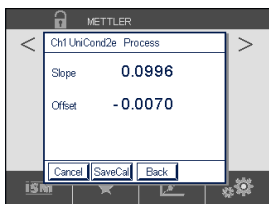

The display shows the value for the slope and the offset as the result of the calibration.

The calibration values are stored in the calibration history. To save (press button SaveCal) or to discard (press button Cancel).

Use the Back button to go one step back in the calibration procedure.

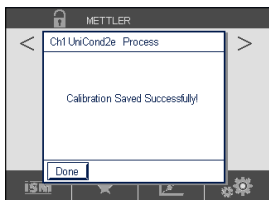

If "SaveCal" is chosen, the message "Calibration Saved Successfully!" is displayed. After pressing the Done button the M800 returns to the Menu Screen.

7.2.2 Temperature Calibration of UniCond2e Sensors and UniCond4e Sensors

The M800 provides the ability to perform a one-point or two-point calibration for the temperature sensor of the UniCond2e and UniCond4e.

Enter the menu Calibrate Sensor (see chapter 7.1 "Sensor Calibration"; PATH: \ Cal \ Calibrate Sensor) and choose the desired channel for calibration.

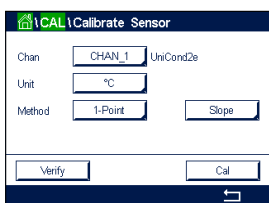

The following menus can be called up:

Unit: Choose between the units °C and °F.

Method: Select the desired calibration procedure. Available are 1-point and 2-point calibration.

7.2.2.1 One-Point Calibration

Select calibration procedure 1-Point. With 2e-sensors or 4e-sensors a one-point temperature calibration can be performed as a slope or offset calibration. The following procedure shows the calibration with a 2e-sensor. The calibration with a 4e-sensor works respectively.

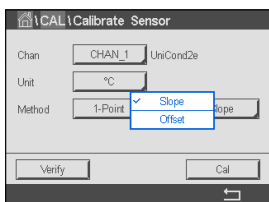

Press the right input field for the parameter **Method**. Choose Slope or Offset calibration through pressing the corresponding field.

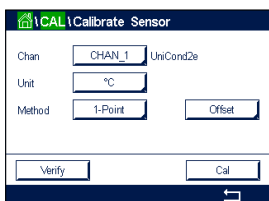

Press the button Cal for starting calibration.

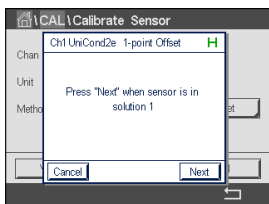

Place the electrode in the reference solution and press Next button.

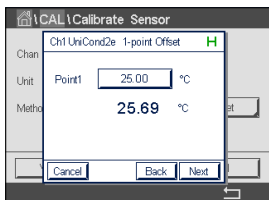

The second value displayed on the screen is the value being measured by the transmitter and sensor.

Press the input field for **Point1** to enter the value for the calibration point. The M800 displays a keypad for modifying the value. Press the \leftarrow button to accept the value.

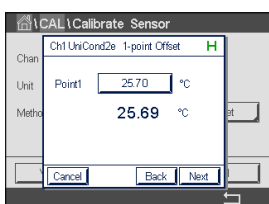

The screen shows the entered value for the reference solution (1st line) and the measured value of the M800 (2nd line).

Press the Next button to start the calculation of the calibration results.

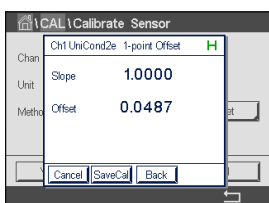

The display shows the value for the slope and the offset as the result of the calibration.

The calibration values are stored in the calibration history. To save (press button SaveCal) or to discard (press button Cancel).

Use the Back button to go one step back in the calibration procedure.

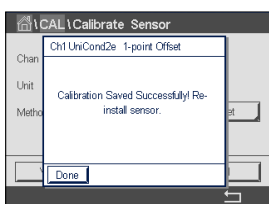

If "SaveCal" is chosen, the message "Calibration Saved Successfully!" is displayed. In either case you will see the message "Please re-install sensor". After pressing the Done button the M800 returns to the calibration menu for the sensor.

7.2.2.2 Two-Point Calibration

Select calibration procedure 2-Point (see chapter 7.2.2 "Temperature Calibration of UniCond2e Sensors and UniCond4e Sensors"). With 2e-sensors or 4e-sensor a two-point calibration is always performed as an offset and slope calibration. The following procedure shows the calibration with a 2e-sensor. The calibration with a 4e-sensor works respectively.

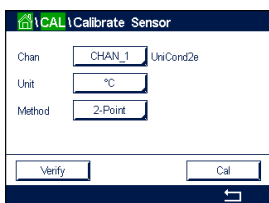

Press the button Cal for starting calibration.

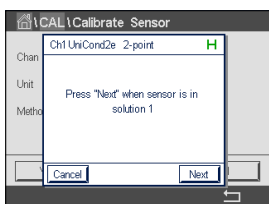

Place the electrode in the first reference solution and press Next button.

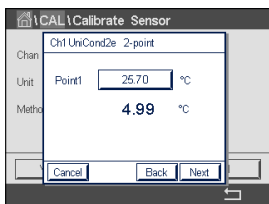

The second value displayed on the screen is the value being measured by the transmitter and sensor in the units selected by the user.

Press the input field for **Point1** to enter the calibration point. The M800 displays a keypad for modifying the value. Press the \leftarrow button and to accept the value.

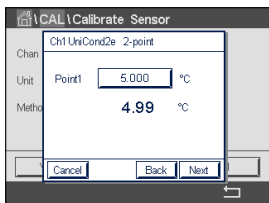

The screen shows the entered value for the first reference solution (1st line) and the measured value of the M800 (2nd line).

Press the Next button to go on with the calibration.

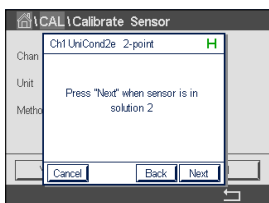

Place the electrode in the second reference solution and press Next button.

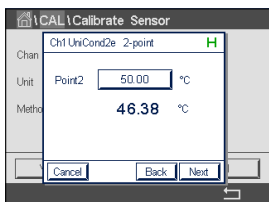

The second value displayed on the screen is the value being measured by the transmitter and sensor in the units selected by the user.

Press the input field for **Point2** to enter the calibration point. The M800 displays a keypad for modifying the value. Press the \leftarrow button and to accept the value.

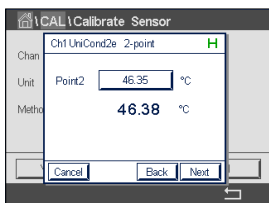

The screen shows the entered value for the second reference solution (1st line) and the measured value of the M800 (2nd line).

Press the Next button to start the calculation of the calibration results.

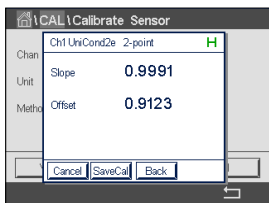

The display shows the value for the slope and the offset as the result of the calibration.

The calibration values are stored in the calibration history. To save (press button SaveCal) or to discard (press button Cancel).

Use the Back button to go one step back in the calibration procedure.

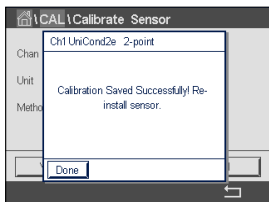

If "SaveCal" is chosen, the message "Calibration Saved Successfully!" is displayed. In either case you will see the message "Please re-install sensor". After pressing the Done button the M800 returns to the calibration menu for the sensor.

7.3 Calibration of Cond2e Sensors or Cond4e Sensors

PATH:  \ Cal \ Calibrate Sensor

The M800 provides the ability to perform a one-point, two-point or process conductivity or resistivity calibration for 2e-sensors and 4e-sensors.



NOTE: When performing calibration on a conductivity sensor, results will vary depending on the method, calibration apparatus and/or quality of reference standards used to perform the calibration.



NOTE: For measuring tasks the temperature compensation for the application as defined through the parameter settings for conductivity will be considered and not the temperature compensation selected through the calibration procedure (see also chapter 8.1.4.1 "Conductivity Settings").

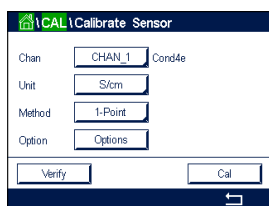

The following menu can be called up:

Unit: Between the units for conductivity and resistivity can be chosen.

Method: Select the desired calibration procedure, 1-point, 2-point or process calibration.

Options: Select the desired temperature compensation mode for the calibration process.



NOTE: If compensation mode "Linear 25 °C" or "Linear 20 °C" has been chosen, the coefficient for the adjustment of the reading can be modified.

The changes are valid until the calibration mode has been exited. After the values defined in the configuration menu are valid again.

7.3.1 One-Point Calibration

With 2e-sensors or 4e-sensors a one-point calibration is always performed as a slope calibration. The following procedure shows the calibration with a 2e-sensor. The calibration with a 4e-sensor works respectively.

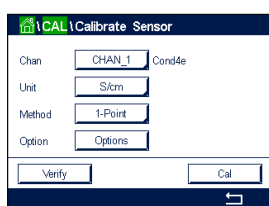

Press the button Cal for starting calibration.

Place the electrode in the reference solution and press Next button.

Enter the value for the calibration point (**Point1**).

Press the Next button to start the calculation of the calibration results.

The display shows the value for the slope and the offset as the result of the calibration.

For ISM sensors press the Adjust button to perform the calibration and store the calculated values in the sensor. Press the Calibrate button to store the calculated values in the sensor. Calibration is not performed. Press the Cancel button to terminate the calibration.

For analog sensors press the SaveCal button to perform the calibration. The calculated values can be viewed as long as the sensor is connected to the transmitter. Press the Cancel button to terminate the calibration.

If "Adjust", "Calibrate" or "SaveCal" is chosen, the message "Calibration Saved Successfully!" is displayed. In either case you will see the message "Please re-install sensor".

7.3.2 Two-Point Calibration

With 2e-sensors or 4e-sensors a two-point calibration is always performed as an offset and slope calibration. The following procedure shows the calibration with a 2e-sensor. The calibration with a 4e-sensor works respectively.

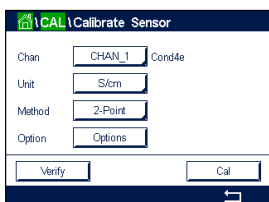

Press the button Cal for starting calibration.

Place the electrode in the first reference solution and press Next button.

CAUTION: Rinse sensors with a high-purity water solution between calibration points to prevent contamination of the reference solutions.

Enter the value for the first calibration point (**Point1**).

Press the Next button to go on with the calibration.

Place the electrode in the second reference solution and press Next button.

Enter the value for the second calibration point (**Point2**).

Press the Next button to start the calculation of the calibration results.

The display shows the value for the slope and the offset as the result of the calibration.

For ISM sensors press the Adjust button to perform the calibration and store the calculated values in the sensor. Press the Calibrate button to store the calculated values in the sensor. Calibration is not performed. Press the Cancel button to terminate the calibration.

For analog sensors press the SaveCal button to perform the calibration. The calculated values can be viewed as long as the sensor is connected to the transmitter. Press the Cancel button to terminate the calibration.

If "Adjust", "Calibrate" or "SaveCal" is chosen, the message "Calibration Saved Successfully!" is displayed. In either case you will see the message "Please re-install sensor".

7.3.3 Process Calibration

With 2e-sensors or 4e-sensors a process calibration is always performed as a slope calibration. The following procedure shows the calibration with a 2e-sensor. The calibration with a 4e-sensor works respectively.

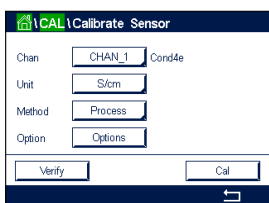

Press the button Cal for starting calibration.

Take a sample and press the \leftarrow button to store the current measuring value. To show the ongoing calibration process, P is blinking in the Start and Menu screen if the related channel is selected in the display.

After determining the conductivity value of the sample, press the calibration icon in the Menu Screen again.

Enter the conductivity value of the sample. Press the Next button to start the calculation of the calibration results.

The display shows the value for the slope and the offset as the result of the calibration.

For ISM sensors press the Adjust button to perform the calibration and store the calculated values in the sensor. Press the Calibrate button to store the calculated values in the sensor. Calibration is not performed. Press the Cancel button to terminate the calibration.

For analog sensors press the SaveCal button to perform the calibration. The calculated values can be viewed as long as the sensor is connected to the transmitter. Press the Cancel button to terminate the calibration.

If "Adjust", "Calibrate" or "SaveCal" is chosen, the message "Calibration Saved Successfully!" is displayed. In either case you will see the message "Please re-install sensor".

7.4 pH Calibration

PATH:  \ Cal \ Calibrate Sensor

For pH sensors, the M800 Transmitter features one-point, two-point or process calibration with 9 preset buffer sets or manual buffer entry. Buffer values refer to 25 °C. To calibrate the instrument with automatic buffer recognition, you need a standard pH buffer solution that matches one of these values. Please select the correct buffer table before using automatic calibration (see chapter 17 "Buffer tables"). The stability of the sensor signal during calibration can be checked by the user or automatically by the transmitter (see chapter 8.1.4.2 "pH Settings").

NOTE: For dual membrane pH electrodes (pH/pNa) only buffer Na+ 3.9M (see chapter 17.2.1 "Mettler-pH/pNa buffers (Na+ 3.9M)") is available.

The following menus can be called up:

Unit: Select pH.

Method: Select the desired calibration procedure, 1-point, 2-point or process calibration.

Options: The buffer used for the calibration and the required stability of the sensor signal during the calibration can be selected (see also chapter 8.1.4.2 "pH Settings"). The changes are valid until the calibration mode has been escaped. After the values defined in the configuration menu are valid again.

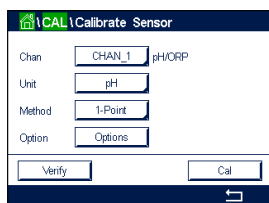

7.4.1 One-Point Calibration

With pH sensors a one-point calibration is always performed as an offset calibration.

Press the button Cal for starting calibration.

Place the electrode in the buffer solution and press the Next button.

The display shows the buffer the transmitter has recognized **Point 1** and the measured value.

The M800 checks the stability of the measuring signal and proceeds as soon as the signal is sufficiently stable.

NOTE: If **option** Stability is set to Manual press 'Next' after the measuring signal is stable enough to go on with the calibration.

The transmitter shows the value for the slope and the offset as the result of the calibration.

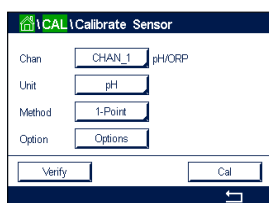

For ISM sensors press the Adjust button to perform the calibration and store the calculated values in the sensor. Press the Calibrate button to store the calculated values in the sensor. Calibration is not performed. Press the Cancel button to terminate the calibration.

For analog sensors press the SaveCal button to perform the calibration. The calculated values can be viewed as long as the sensor is connected to the transmitter. Press the Cancel button to terminate the calibration.

If "Adjust", "Calibrate" or "SaveCal" is chosen, the message "Calibration Saved Successfully!" is displayed. In either case you will see the message "Please re-install sensor".

7.4.2 Two-Point Calibration

With pH sensors a two-point calibration is always performed as calibration of slope and offset.

Press the Cal button to start calibration.

Place the electrode in buffer solution 1 and press Next button.

The display shows the buffer the transmitter has recognized **Point 1** and the measured value.

The M800 checks the stability of the measuring signal and proceeds as soon as the signal is sufficiently stable.

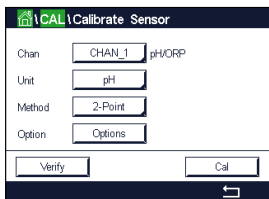

NOTE: If **option** Stability is set to Manual press 'Next' after the measuring signal is stable enough to go on with the calibration.

The transmitter prompts you to place the electrode in the second buffer solution.

Press the Next button to proceed with the calibration.

The display shows the buffer the transmitter has recognized **Point 2** and the measured value.

The M800 checks the stability of the measuring signal and proceeds as soon as the signal is sufficiently stable.



NOTE: If **option** Stability is set to Manual press 'Next' after the measuring signal is stable enough to go on with the calibration.

The transmitter shows the value for the slope and the offset as the result of the calibration.

For ISM sensors press the Adjust button to perform the calibration and store the calculated values in the sensor. Press the Calibrate button to store the calculated values in the sensor. Calibration is not performed. Press the Cancel button to terminate the calibration.

For analog sensors press the SaveCal button to perform the calibration. The calculated values can be viewed as long as the sensor is connected to the transmitter. Press the Cancel button to terminate the calibration.

If "Adjust", "Calibrate" or "SaveCal" is chosen, the message "Calibration Saved Successfully!" is displayed. In either case you will see the message "Please re-install sensor".

7.4.3 Process Calibration

With pH sensors a process calibration is always performed as an offset calibration.

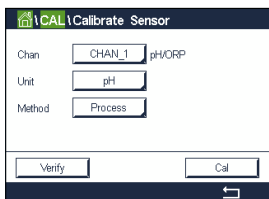

Press the Cal button to start calibration.

Take a sample and press the \leftarrow button to store the current measuring value. To show the ongoing calibration process, P is blinking in the Start and Menu Screen if the related channel is selected in the display.

After determining the pH value of the sample, press the calibration icon in the Menu Screen again.

Enter the pH value of the sample. Press the Next button to start the calculation of the calibration results.

The display shows the value for the slope and the offset as the result of the calibration.

For ISM sensors press the Adjust button to perform the calibration and store the calculated values in the sensor. Press the Calibrate button to store the calculated values in the sensor. Calibration is not performed. Press the Cancel button to terminate the calibration.

For analog sensors press the SaveCal button to perform the calibration. The calculated values can be viewed as long as the sensor is connected to the transmitter. Press the Cancel button to terminate the calibration.

If "Adjust", "Calibrate" or "SaveCal" is chosen, the message "Calibration Saved Successfully!" is displayed. In either case you will see the message "Please re-install sensor".

7.5 ORP Calibration of pH Sensors

PATH: \ Cal \ Calibrate Sensor

For pH sensors with solution ground based on ISM technology the M800 Transmitter gives the option to make, in addition to the pH calibration, an ORP calibration.



NOTE: In case of choosing ORP calibration the parameters defined for pH (see chapter 8.1.4.2 "pH Settings") will not be considered. For pH sensors, the M800 Transmitter features one-point calibration for ORP.

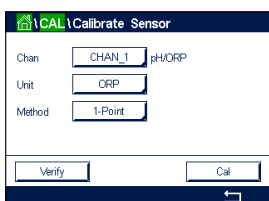

The following menus can be called up:

Unit: Select ORP through pressing the corresponding field.

Method: 1-Point calibration is displayed.

Press the button Cal for starting calibration.

Enter the value for calibration point 1 (**Point1**).

Press the Next button to start the calculation of the calibration results.

The display shows the value for the slope and the offset as the result of the calibration.

For ISM sensors press the Adjust button to perform the calibration and store the calculated values in the sensor. Press the Calibrate button to store the calculated values in the sensor. Calibration is not performed. Press the Cancel button to terminate the calibration.
 For analog sensors press the SaveCal button to perform the calibration. The calculated values can be viewed as long as the sensor is connected to the transmitter. Press the Cancel button to terminate the calibration.

If "Adjust", "Calibrate" or "SaveCal" is chosen, the message "Calibration Saved Successfully!" is displayed. In either case you will see the message "Please re-install sensor".

7.6 Calibration of Amperometric Oxygen Sensors

PATH:  \ Cal \ Calibrate Sensor

The M800 provides the ability to perform a one-point or process calibration for amperometric oxygen sensors.



NOTE: Before air calibration, for highest accuracy, enter the barometric pressure and relative humidity, as described in chapter 8.1.4.3 "Settings for Oxygen Measurement Based on Amperometric Sensors".

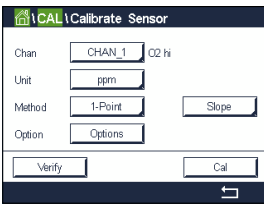

The following menus can be called up:

- Unit:** Between several units for DO and O₂ gas can be chosen.
- Method:** Select the desired calibration procedure, 1-point or process calibration.
- Options:** In case the method 1-point has been chosen the calibration pressure, relative humidity and - for slope calibration - the stability mode for the sensor signal during the calibration can be selected. For the method Process the values for the process pressure, calibration pressure and the parameter ProcCalPress can be modified. See also chapter 8.1.4.3 "Settings for Oxygen Measurement Based on Amperometric Sensors". The changes are valid until the calibration mode has been escaped. After the values defined in the configuration menu are valid again.

7.6.1 One-Point Calibration

A one-point calibration of oxygen sensors is always either a one-point slope (i.e. with air) or a zero (offset) calibration. A one-point slope calibration is done in air and a one-point offset calibration is done at 0 ppb oxygen. A one-point zero dissolved oxygen calibration is available but not normally recommended since zero oxygen is very hard to achieve. A zero-point calibration is only recommended if high accuracy at low oxygen level (below 5% air) is needed.

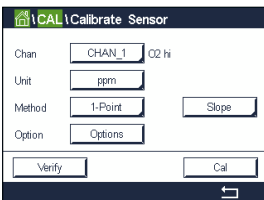

Choose Slope or Offset calibration through pressing the corresponding field.

Press the button Cal for starting calibration.

NOTE: If the polarization voltage for the measuring mode and calibration mode is different, the transmitter will wait 120 seconds before starting the calibration. In this case the transmitter will also go after the calibration for 120 seconds to the HOLD Mode, before returning to the measuring mode again.

Place the sensor in air or the calibration gas and press Next button

Enter the value for the calibration point (**Point1**).

The M800 checks the stability of the measuring signal and proceeds as soon as the signal is sufficiently stable.



NOTE: If **option** Stability is set to Manual press 'Next' after the measuring signal is stable enough to go on with the calibration.



NOTE: For an offset calibration the Auto mode is not available. If Auto mode has been chosen and afterwards slope calibration has been changed to offset calibration, the transmitter will perform the calibration in Manual mode.

The transmitter shows the value for the slope and the offset as the result of the calibration.

For ISM sensors press the Adjust button to perform the calibration and store the calculated values in the sensor. Press the Calibrate button to store the calculated values in the sensor. Calibration is not performed. Press the Cancel button to terminate the calibration.

For analog sensors press the SaveCal button to perform the calibration. The calculated values can be viewed as long as the sensor is connected to the transmitter. Press the Cancel button to terminate the calibration.

If "Adjust", "Calibrate" or "SaveCal" is chosen, the message "Calibration Saved Successfully!" is displayed. In either case you will see the message "Please re-install sensor".

7.6.2 Process Calibration

A process calibration of oxygen sensors is always either a slope or an offset calibration.

Choose Slope or Offset calibration through pressing the corresponding field.

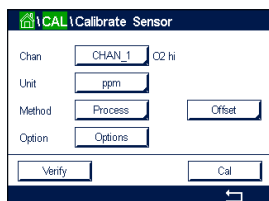

Press the Cal button to start calibration.

Take a sample and press the \leftarrow button to store the current measuring value. To show the ongoing calibration process, P is blinking in the Start and Menu screen if the related channel is selected in the display.

After determining the oxygen value of the sample, press the calibration icon in the Menu Screen again.

Enter the oxygen value of the sample. Press the Next button to start the calculation of the calibration results.

The display shows the value for the slope and the offset as the result of the calibration.

For ISM sensors press the Adjust button to perform the calibration and store the calculated values in the sensor. Press the Calibrate button to store the calculated values in the sensor. Calibration is not performed. Press the Cancel button to terminate the calibration.

For analog sensors press the SaveCal button to perform the calibration. The calculated values can be viewed as long as the sensor is connected to the transmitter. Press the Cancel button to terminate the calibration.

If "Adjust", "Calibrate" or "SaveCal" is chosen, the message "Calibration Saved Successfully!" is displayed.

7.7 Calibration of Optical Oxygen Sensors (ISM Sensors only)

PATH:  \ Cal \ Calibrate Sensor

Oxygen calibration for optical sensors can be performed as a two-point, process or, depending on the sensor model connected to the transmitter, also as a one-point calibration.



NOTE: Before air calibration, for highest accuracy, enter the barometric pressure and relative humidity, as described in chapter 8.1.4.4 "Settings for Oxygen Measurement Based on Optical Sensors".

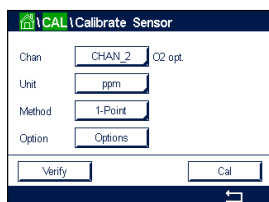

The following menus can be called up:

- Unit:** Between several units can be chosen. The units are displayed during the calibration.
- Method:** Select the desired calibration procedure, 1-point, 2-point or process calibration.
- Options:** In case the method 1-point has been chosen the calibration pressure, relative humidity and the stability mode for the sensor signal during the calibration can be selected. For the method Process the values for the process pressure, calibration pressure, the parameter ProcCalPress and the mode of the process calibration can be modified. See also chapter 8.1.4.4 "Settings for Oxygen Measurement Based on Optical Sensors". The changes are valid until the calibration mode has been escaped. After the values defined in the configuration menu are valid again.

7.7.1 One-Point Calibration

Typically a one-point calibration is done in air. Nevertheless other calibration gases and solutions are possible.

The calibration of an optical sensor is always a calibration of the phase of the fluorescence signal towards the internal reference. During a one-point calibration the phase in this point is measured and extrapolated over the measuring range.

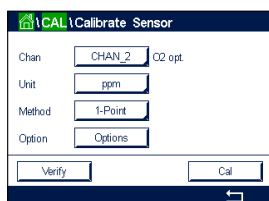

Press the button Cal for starting calibration.

Place the sensor in air or the calibration gas and press Next button

Enter the value for the calibration point (**Point1**).

The M800 checks the stability of the measuring signal and proceeds as soon as the signal is sufficiently stable.



NOTE: If **option** Stability is set to Manual press 'Next' after the measuring signal is stable enough to go on with the calibration.

The transmitter shows the value for the phase of the sensor at 100% air (P100) and at 0% air (P0) as the result of the calibration.

Press the Adjust button to perform the calibration and store the calculated values in the sensor. Press the Calibrate button to store the calculated values in the sensor. Calibration is not performed. Press the Cancel button to terminate the calibration.

If "Adjust" or "Calibrate" are chosen, the message "Calibration Saved Successfully!" is displayed. In either case you will see the message "Please re-install sensor".

7.7.2 Two-Point Calibration

The calibration of an optical sensor is always a calibration of the phase of the fluorescence signal towards the internal reference. A two-point calibration is a combination of first a calibration in air (100%) where a new phase P100 is measured and then a calibration in nitrogen (0%) where a new phase P0 is measured. This calibration routine gives the most accurate calibration curve over the whole measuring range.

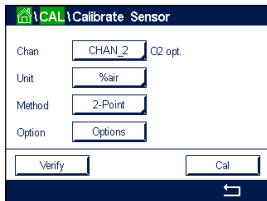

Press the Cal button to start calibration.

Place the sensor in air or the calibration gas and press Next button

Enter the value for the first calibration point (**Point1**).

The M800 checks the stability of the measuring signal and proceeds as soon as the signal is sufficiently stable.



NOTE: If **option** Stability is set to Manual press 'Next' after the measuring signal is stable enough to go on with the calibration.

The transmitter prompts you to change the gas.

Press the Next button to proceed with the calibration.

The M800 checks the stability of the measuring signal and proceeds as soon as the signal is sufficiently stable.



NOTE: If **option** Stability is set to Manual press 'Next' after the measuring signal is stable enough to go on with the calibration.

The transmitter shows the value for the phase of the sensor at 100% air (P100) and at 0% air (P0) as the result of the calibration.

Press the Adjust button to perform the calibration and store the calculated values in the sensor. Press the Calibrate button to store the calculated values in the sensor. Calibration is not performed. Press the Cancel button to terminate the calibration.

If "Adjust" or "Calibrate" are chosen, the message "Calibration Saved Successfully!" is displayed. In either case you will see the message "Please re-install sensor".

7.7.3 Process Calibration

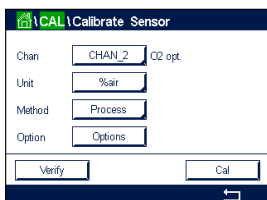

Press the Cal button to start calibration.

Take a sample and press the \leftarrow button to store the current measuring value. To show the ongoing calibration process, P is blinking in the start and Menu Screen if the related channel is selected in the display.

After determining the oxygen value of the sample, press the calibration icon in the Menu Screen.

Enter oxygen value of the sample. Press the Next button to start the calculation of the calibration results.

The display shows now the values for the phase of the sensor at 100% air (P100) and at 0% (P0) air.

Press the Adjust button to perform the calibration and store the calculated values in the sensor. Press the Calibrate button to store the calculated values in the sensor. Calibration is not performed. Press the Cancel button to terminate the calibration.



NOTE: If for process calibration Scaling has been chosen (see chapter 8.1.4.4 “Settings for Oxygen Measurement Based on Optical Sensors”) the calibration values are not stored in the calibration history.

If “Adjust” or “Calibrate” are chosen, the message “Calibration Saved Successfully!” is displayed.

7.8 Calibration of Dissolved Carbon Dioxide Sensors (ISM Sensors only)

For dissolved carbon dioxide (CO₂) sensors, the M800 Transmitter features one-point, two-point or process calibration. For the one-point or two-point calibration the solution with pH = 7.00 and/or pH = 9.21 of the Mettler – 9 standard buffer can be used (see also chapter 8.1.4.5 “Dissolved Carbon Dioxide Settings”) or the buffer value can be entered manually.

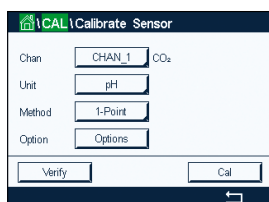

The following menus can be called up:

Unit: Between several units for partial pressure, and dissolved carbon dioxide can be selected.

Method: Select the desired calibration procedure, 1-point or process calibration.

Options: The buffer used for the calibration and the required stability of the sensor signal during the calibration can be selected (see also chapter 8.1.4.5 “Dissolved Carbon Dioxide Settings”). The changes are valid until the calibration mode has been escaped. After the values defined in the configuration menu are valid again.

7.8.1 One-Point Calibration

With CO₂ sensors a one-point calibration is always performed as an offset calibration.

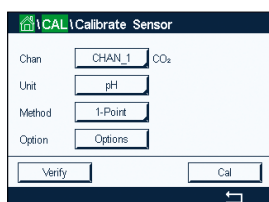

Press the button Cal for starting calibration.

Place the electrode in the buffer solution and press the Next button.

The display shows the buffer the transmitter has recognized **Point 1** and the measured value.

The M800 checks the stability of the measuring signal and proceeds as soon as the signal is sufficiently stable.



NOTE: If **option** Stability is set to Manual press ‘Next’ after the measuring signal is stable enough to go on with the calibration.

The transmitter shows the value for the slope and the offset as the result of the calibration.

Press the Adjust button to perform the calibration and store the calculated values in the sensor. Press the Calibrate button to store the calculated values in the sensor. Calibration is not performed. Press the Cancel button to terminate the calibration.

If “Adjust” or “Calibrate” are chosen, the message “Calibration Saved Successfully!” is displayed. In either case you will get the message “Please re-install sensor”.

7.8.2 Two-Point Calibration

With CO₂ sensors a two-point calibration is always performed as calibration of slope and offset.

Press the Cal button to start calibration.

Place the electrode in buffer solution 1 and press Next button.

The display shows the buffer the transmitter has recognized **Point 1** and the measured value.

The M800 checks the stability of the measuring signal and proceeds as soon as the signal is sufficiently stable.

NOTE: If **option** Stability is set to Manual press 'Next' after the measuring signal is stable enough to go on with the calibration.

The transmitter prompts you to place the electrode in the second buffer solution.

Press the Next button to proceed with the calibration.

The display shows the buffer the transmitter has recognized **Point 2** and the measured value.

The M800 checks the stability of the measuring signal and proceeds as soon as the signal is sufficiently stable.

NOTE: If **option** Stability is set to Manual press 'Next' after the measuring signal is stable enough to go on with the calibration.

The transmitter shows the value for the slope and the offset as the result of the calibration.

Press the Adjust button to perform the calibration and store the calculated values in the sensor. Press the Calibrate button to store the calculated values in the sensor. Calibration is not performed. Press the Cancel button to terminate the calibration.

If "Adjust" or "Calibrate" are chosen, the message "Calibration Saved Successfully!" is displayed. In either case you will see the message "Please re-install sensor".

7.8.3 Process Calibration

With CO₂ sensors a process calibration is always performed as an offset calibration.

Press the Cal button to start calibration.

Take a sample and press the  button to store the current measuring value. To show the ongoing calibration process, P is blinking in the Start and Menu Screen if the related channel is selected in the display.

After determining the corresponding value of the sample, press the calibration icon in the Menu Screen again.

Enter the value of the sample. Press the Next button to start the calculation of the calibration results.

The display shows the value for the slope and the offset as the result of the calibration.

Press the Adjust button to perform the calibration and store the calculated values in the sensor.

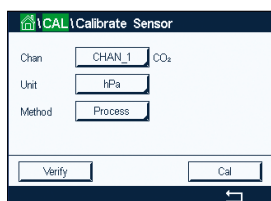
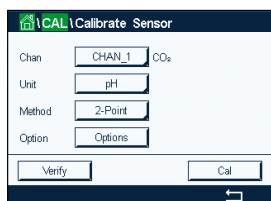

Press the Calibrate button to store the calculated values in the sensor. Calibration is not performed. Press the Cancel button to terminate the calibration. If "Adjust" or "Calibrate" are chosen, the message "Calibration Saved Successfully!" is displayed.

7.9 Calibration of Thermal Conductivity CO₂ (CO₂ high) Sensors (ISM Sensors only)

PATH: H \ Cal \ Calibrate Sensor

The M800 provides the ability to perform a one-point calibration using a reference gas (CO₂) with a known carbon dioxide partial pressure value. It offers also to perform a process calibration based on a analyzed process sample.



NOTE: The sensor is designed to measure CO₂ partial pressure or concentration values accurately in liquid phase only! In gas phase the sensor will only show correct CO₂ gas partial pressure values in the 1-point calibration menu.

The following menus can be called up:

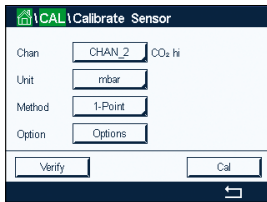

Unit: Between the units of CO₂ pressure or concentration can be chosen.

Method/Options: Select the desired calibration procedure, 1-point or process calibration and stability option (manual/auto).

In case the method 1-point has been chosen only the calibration pressure and the option stability mode for the sensor signal during the calibration can be selected (Sensor expects to be in a calibration gas).

For the method Process only concentration values can be chosen as pressure or concentration values (Sensor expects to be in liquids).



NOTE: With reference Gas (CO₂) use 1-point calibration. With liquids use process calibration. When changing MembraCap always first perform a 1-point gas calibration. The changes are valid until the calibration mode has been exited. After the values defined in the Configuration menu are valid again.

7.9.1 One-Point Calibration

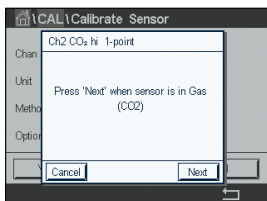

With the thermal conductivity sensor a one-point calibration is always performed as a slope calibration. Press the button Cal for starting calibration.

Expose the TC-Sensor to a reference gas of a known CO₂ concentration and press Next button. Enter the value for the calibration point (Point1) in mbar or hPa.

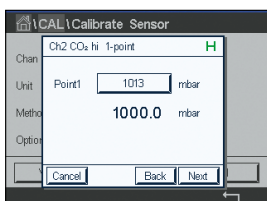

Press the Next button to start the calculation of the calibration results.

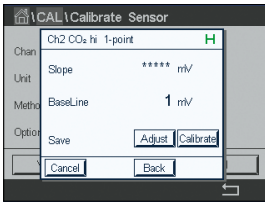

The display shows the value for the slope and the baseline as the result of the calibration. Press the Adjust button to perform the calibration and store the calculated values in the sensor. Press the Calibrate button to store the calculated values in the sensor. Calibration is not performed. Press the Cancel button to terminate the calibration.

If "Adjust" or "Calibrate" are chosen, the message "Calibration Saved Successfully!" is displayed.

7.9.2 Process Calibration

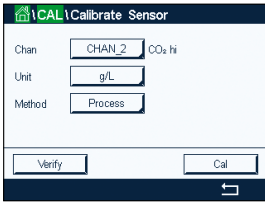

With the thermal conductivity sensor a process calibration is always performed as a slope calibration.

Choose process calibration and desired unit in the calibration menu. Press the button Cal for starting calibration.

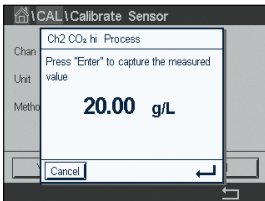

Take a sample and press the \leftarrow button to store the current measuring value. To show the ongoing calibration process, P is blinking in the Start and Menu screen if the related channel is selected on the display.

After determining the CO₂ value of the sample, press the calibration icon in the Menu Screen again. Enter the CO₂ value of the sample.

Press the Next button to start the calculation of the calibration results.

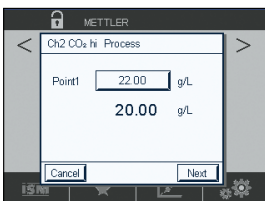

The display shows the value for the slope and the baseline as the result of the calibration.

Press the Adjust button to perform the calibration and store the calculated values in the sensor. Press the Calibrate button to store the calculated values in the sensor. Calibration is not performed. Press the Cancel button to terminate the calibration.

If "Adjust" or "Calibrate" are chosen, the message "Calibration Saved Successfully!" is displayed.

7.10 Calibration of O₃ Sensors (ISM Sensors only)

The M800 provides the ability to perform a 1-Point or process calibration for O₃ sensors. Dissolved Ozone must be performed quickly because O₃ decays rapidly into oxygen, especially at warm temperatures.

Enter the menu Calibrate Sensor (see chapter 7.1 "Sensor Calibration"; PATH: \leftarrow Cal\Calibrate Sensor) and choose the desired channel for calibration.

The following menus can be called up:

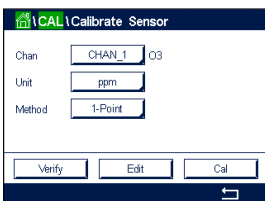

Unit: Several units for dissolved O₃ can be chosen.

Method: Select the desired calibration procedure, 1-Point or process calibration.

7.10.1 One-Point Calibration

Select the 1-Point calibration method. A one-point calibration of O₃ sensors is always a zero (offset) calibration

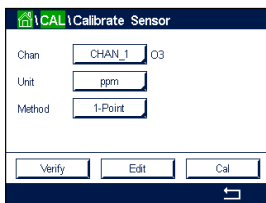

Press the button Cal for starting calibration.

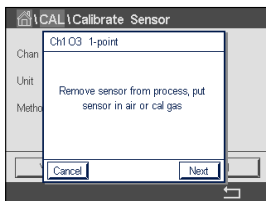

Place the sensor in the calibration gas, such as air, and press the Next button.

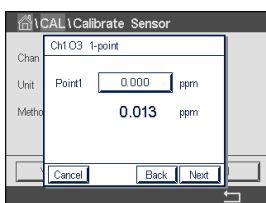

The second value displayed on the screen is the value being measured by the transmitter and sensor in the units selected by the user.

Press the input field for **Point1** to enter the value for the calibration point. The M800 displays a keypad for modifying the value. Press the \leftarrow button to accept the value.

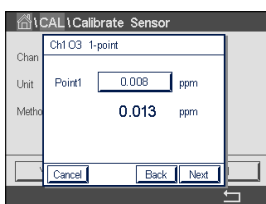

The screen shows the entered value for the reference solution (1st line) and the measured value of the M800 (2nd line).

When the measuring signal is stable, press Next to continue with the calibration

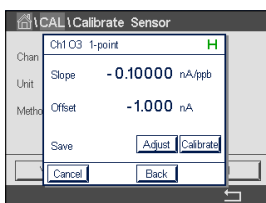

The display shows the value for the slope and the offset as result of the calibration.

Press the Adjust button to perform the calibration and store the calculated values in the sensor. Press the Calibrate button to store the calculated values in the sensor. Calibration is not performed. Press the Cancel button to terminate the calibration.

Use the Back button to go one step back in the calibration procedure

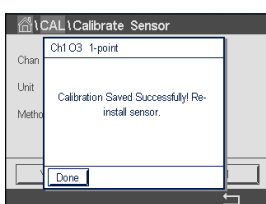

If "Adjust" or "Calibrate" are chosen, the message "Calibration Saved Successfully!" is displayed. In either case you will see the message "Please re-install sensor". After pressing the Done button the M800 returns to the calibration menu.

7.10.2 Process Calibration

Select the Process calibration method. A Process calibration of O₃ sensors can be performed as a slope or offset calibration.

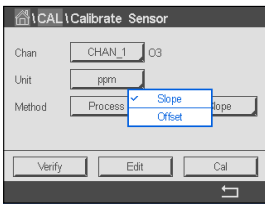

Select the desired calibration **Method**.

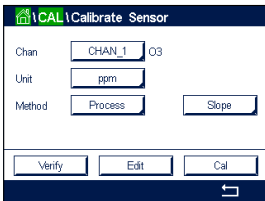

Press Cal to start the calibration.

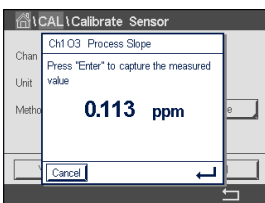

Take a sample and press the \leftarrow button to store the current measuring value. "P" will blink in the measurement screen indicating a Process calibration is active.

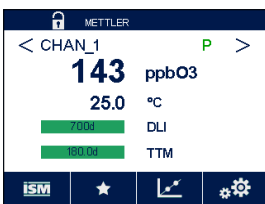

After determining the O₃ value of the sample, press the calibration icon to complete the Process calibration.

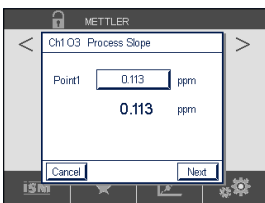

Press the input field for **Point1** and enter the O₃ value of the sample. Press the \leftarrow button to accept the value.

Press the Next button to start the calculation of the calibration results.

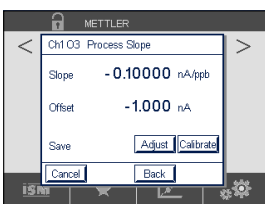

The display shows the value for the slope and the offset as the result of the calibration.

Press the Adjust button to perform the calibration and store the calculated values in the sensor. Press the Calibrate button to store the calculated values in the sensor. Calibration is not performed. Press the Cancel button to terminate the calibration.

Use the Back button to go one step back in the calibration procedure.



If "Adjust" or "Calibrate" are chosen, the message "Calibration Saved Successfully!" is displayed. After pressing the Done button the M800 returns to the Menu Screen

7.11 Calibration of Flow Sensors (ISM Sensors only)

The M800 Transmitter provides the ability to perform a 1-Point or 2-Point Sensor calibration for flow, Edit of saved calibration constants, and Verify of the flow signal. The most common method of calibration for flow sensors is to enter the calibration constants appropriate for the sensor using the Edit function. Some users may choose to perform an in-line calibration using a 1-point or 2-point Sensor flow calibration. This requires an external reference system. When performing an in-line calibration on a flow sensor, results will vary depending on the methods and calibration apparatus used to perform the calibration.

Enter the menu Calibrate Sensor (see chapter 7.1 "Sensor Calibration"; PATH:  \Cal\Calibrate Sensor) and choose the desired channel for calibration.



NOTE: The channel for Flow Type 2 cannot be selected. The M800 Transmitter allows during the Guided Setup (see chapter 6 "Guided Setup") to enter a table of K and F factors

Select the channel (4-channel models only) and the desired calibration option. Choices are GPM, liters/minute meters³/hour, ft/sec, or meters/sec (for a 1-Point or 2-Point flow calibration), Edit and Verify. Press [ENTER].

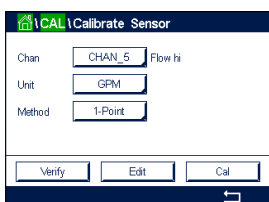

The following menus can be called up:

Unit: Several units for Flow can be chosen.

Method: Select the desired calibration procedure, 1-point or 2-point calibration.

7.11.1 One-Point Calibration

Select calibration method 1-Point . A one-point calibration of a Flow sensor is always a slope calibration.

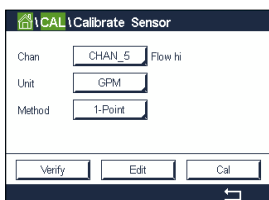

Press Cal to start the calibration.

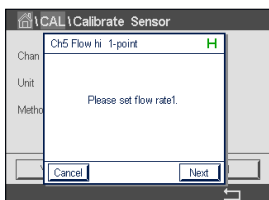

Set the desired flow rate and press Next.

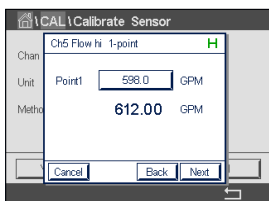

The second value displayed on the screen is the value being measured by the transmitter and sensor in the units selected by the user.

Press the input field for **Point1** to enter the value for the calibration point. The M800 displays a keypad for modifying the value. Press the  button to accept the value.

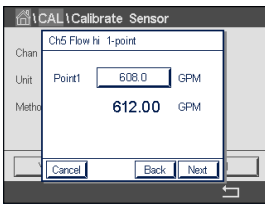

The screen shows the entered value for the reference system (1st line) and the measured value of the M800 (2nd line).

Press the Next button to start the calculation of the calibration results.

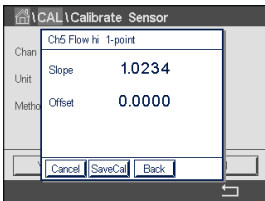

The display shows the value for the slope and the offset as result of the calibration.

Selecting Cancel will discard the entered values and the M800 will return to the calibration menu.

Use the Back button to go one step back in the calibration procedure.

Press SaveCal to save the calibration factors.

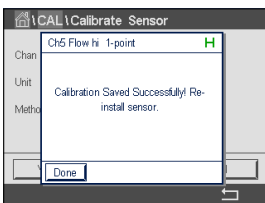

If "SaveCal" is chosen, "Calibration Saved Successfully" and "Please re-install sensor" is displayed. After pressing the Done button the M800 returns to the calibration menu.

7.11.2 Two-Point Calibration

Select calibration method 2-Point . A 2-point calibration of a Flow sensor calculates a new slope and offset.

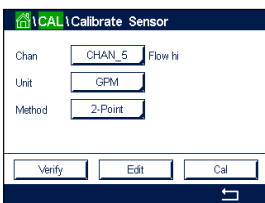

Press Cal to start the calibration

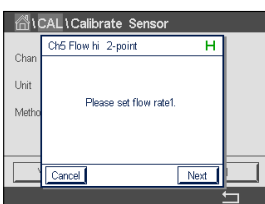

Set the desired flow rate for the first point and press Next.

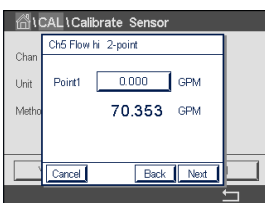

The second value displayed on the screen is the value being measured by the transmitter and sensor in units selected by the user.

Press the input field for **Point1** to enter the value for the calibration point. The M800 displays a keypad for modifying the value. Press the \leftarrow button to accept the value.

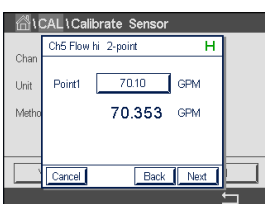

The screen shows the entered value for the reference system (1st line) and the measured value of the M800 (2nd line).

Press Next to continue the calibration.

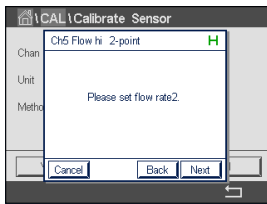

Set the desired flow rate for the second point and press Next.

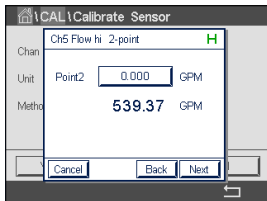

The second value displayed on the screen is the value being measured by the transmitter and sensor in units selected by the user.

Press the input field for **Point2** to enter the value for the calibration point. The M800 displays a keypad for modifying the value. Press the \leftarrow button to accept the value.

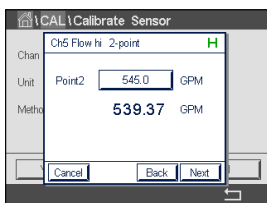

The screen shows the entered value for the reference system (1st line) and the measured value of the M800 (2nd line).

Press the Next button to start the calculation of the calibration results.

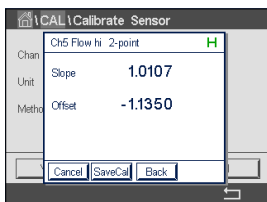

The display shows the value for the slope and the offset as result of the calibration.

Selecting Cancel will discard the entered values and the M800 will return to the calibration menu.

Use the Back button to go one step back in the calibration procedure.

Press SaveCal to save the calibration factors.

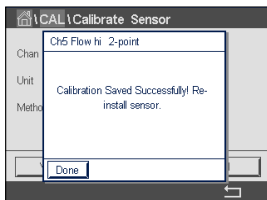

If "SaveCal" is chosen, "Calibration Saved Successfully" and "Please re-install sensor" is displayed. After pressing the Done button the M800 returns to the calibration menu.

7.12 Turbidity Calibration (InPro8000 Series)

Enter the menu Calibrate Sensor (see chapter 7.1 "Sensor Calibration";
 PATH: \leftarrow Cal\Calibrate Sensor).

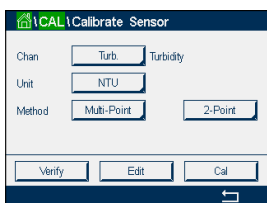

The following menus can be called up:

Unit: Several units for Turbidity can be chosen.

Method: Select the desired calibration procedure, Multi-Point, Process or In-Situ calibration.

7.12.1 Multi-Point Calibration

Select calibration method Multi-Point. Select 2-Point, 3-Point, 4-Point or 5-Point calibration with the other button in the line. The multi-point calibration is always performed as an offset and slope calibration.



NOTE: The calibration always starts with the highest concentration e.g. turbidity value.

The following procedure shows the 2-Point calibration with two reference solutions. The 3-Point, 4-Point or 5-Point calibration works with 3, 4 or 5 reference solutions respectively.

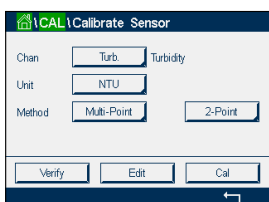

Press the Cal button to start the calibration

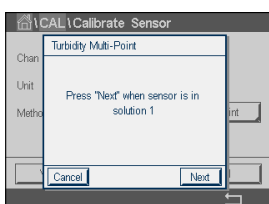

Place the sensor in the reference solution with the highest concentration and press Next button.

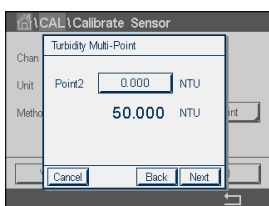

The second value displayed on screen is the value being measured by the transmitter and sensor in the units selected by the user.

Press the input field for Point2 to enter the calibration point. The M800 displays a keypad for modifying the value. Press the \leftarrow button to accept the value.



NOTE: To select another unit for the entered value on the keypad press the U button. To return again press the 0-9 button.

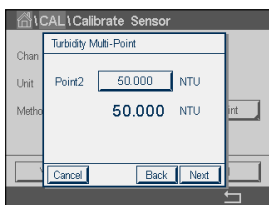

The screen shows the entered value for the reference solution (1st line) and the measured value of the M800 (2nd line).

Press the Next button to start the calculation of the calibration results.

Place the sensor in the reference solution with the lowest concentration and press Next button.

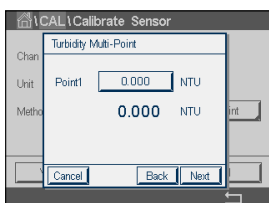

Press the input field for Point 1 to enter the calibration point. The M800 displays a keypad for modifying the value. Press the \leftarrow button to accept the value.



NOTE: To select another unit for the entered value on the keypad press the U button. To return again press the 0-9 button.

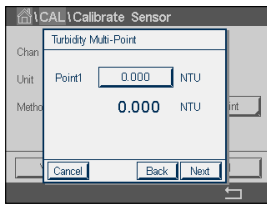

The screen shows the entered value for the reference solution (1st line) and the measured value of the M800 (2nd line).

Press the Next button to start the calculation of the calibration results.

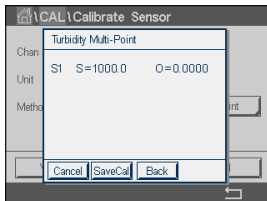

The display shows the value for the slope and the offset as the result of the calibration.

Press the SaveCal button to save the calibration. Press the Cancel button to terminate the calibration. Use the Back button to go one step back in the calibration procedure.

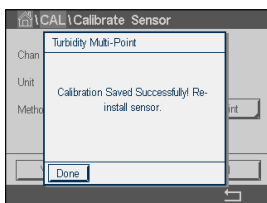

If "SaveCal" is chosen, the message "Calibration Saved Successfully!" is displayed. In either case you will see the message "Please re-install sensor". After pressing the Done button the M800 returns to the calibration menu for the sensor.

7.12.2 Process Calibration

Select calibration procedure Process (see chapter 7.12 "Turbidity Calibration (InPro8000 Series)"). A process calibration is performed as a slope or offset calibration.

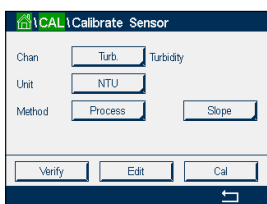

Press the Cal button for starting calibration.

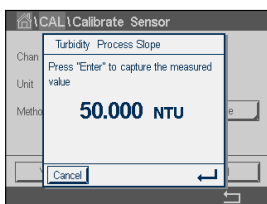

Take a sample and press the \leftarrow button to store the current measuring value. To show the ongoing calibration process, P is blinking in the Start and Menu screen if the related channel is selected in the display.

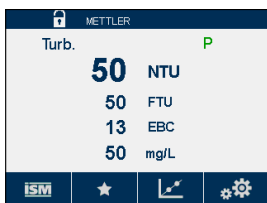

After determining the turbidity value of the sample, press the calibration icon in the Menu Screen (see chapter 3.4.2.1 "Enter the Main Menus") again.

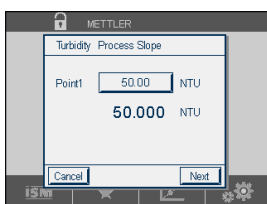

Press the input field for **Point1** and enter the turbidity value of the sample. Press the Next button to start the calculation of the calibration results.

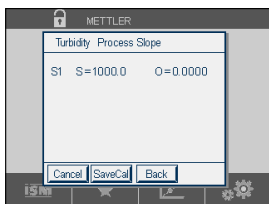

The display shows the value for the slope and the offset as the result of the calibration.

Press the SaveCal button to save the calibration. Press the Cancel button to terminate the calibration. Use the Back button to go one step back in the calibration procedure.



If "SaveCal" is chosen, the message "Calibration Saved Successfully!" is displayed. After pressing the Done button the M800 returns to the Menu Screen.

7.12.3 In-Situ Calibration

Select calibration procedure In-Situ (see chapter 7.12.1 "Turbidity Calibration"). Select 2-Point, 3-Point, 4-Point or 5-Point calibration with the other button in the line. The in-situ calibration is always performed as an offset and slope calibration.

The following procedure shows the 2-Point calibration with two reference solutions. The 3-Point, 4-Point or 5-Point calibration works with 3, 4 or 5 reference solutions respectively

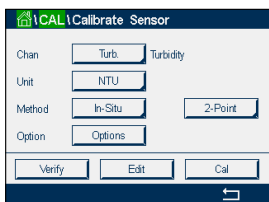

Press Options button to change the gain: Low/Low (default), Low/High or High/High. The higher the gain the higher the risk that calibration is stopped at higher turbidity due to signal overload. In this case restart calibration with lower gain.

Press the Cal button for starting calibration.

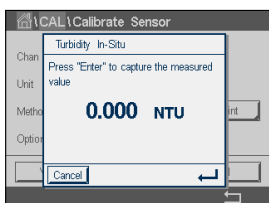

Take a sample and press the \leftarrow button to store the current measuring value. To show the ongoing calibration process, C is blinking in the Start and Menu screen if the related channel is selected in the display.

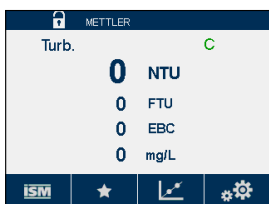

After determining the turbidity value of the sample, press the calibration icon in the Menu Screen (see chapter 3.4.2.1 "Enter the Main Menus") again.

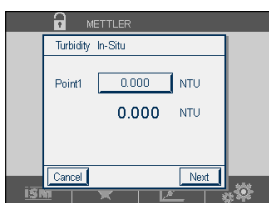

Press the input field for **Point1** and enter the turbidity value of the sample. Press the Next button to start the calculation of the calibration results.

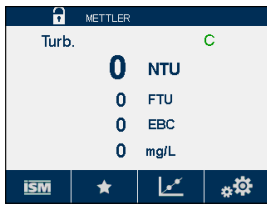

After determining the turbidity value of the sample, press the calibration icon in the Menu Screen (see chapter 3.4.2.1 "Enter the Main Menus") again.

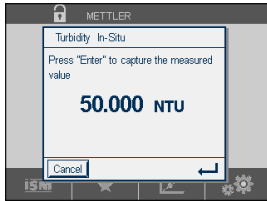

Take another sample and press the \leftarrow button to store the current measuring value. To show the ongoing calibration process, C is blinking in the Start and Menu screen if the related channel is selected in the display.

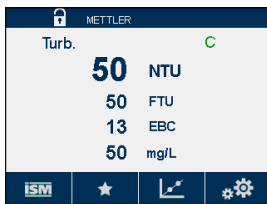

After determining the turbidity value of the sample, press the calibration icon in the Menu Screen (see chapter 3.4.2.1 "Enter the Main Menus") again.

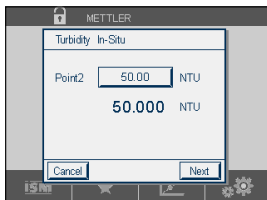

Press the input field for **Point2** and enter the turbidity value of the sample. Press the Next button to start the calculation of the calibration results.

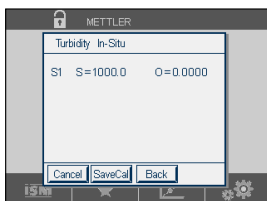

The display shows the value for the slope and the offset as the result of the calibration.

Press the SaveCal button to save the calibration. Press the Cancel button to terminate the calibration. Use the Back button to go one step back in the calibration procedure.

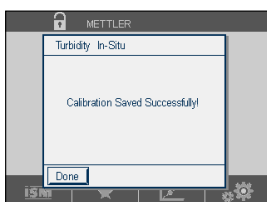

If "SaveCal" is chosen, the message "Calibration Saved Successfully!" is displayed. After pressing the Done button the M800 returns to the Menu Screen.

7.12.4 Manual Calibration (Edit)

In the Manual Calibration mode the values for gain, slope and offset are entered directly.

Press Edit button for starting calibration.

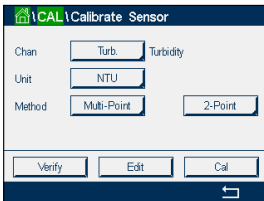

Press the input field for Options to change the gain: Low/Low (default), Low/High or High/High. The higher the gain the higher the risk that calibration is stopped at higher turbidity due to signal overload. In this case restart calibration with lower gain.

Press the Next button.

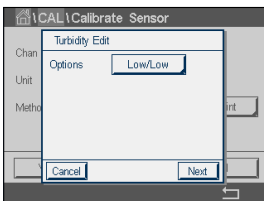

Press the input field for Slope to change the slope. Press the input field for Offset to change the offset.

The third line shows the current measured value.

Press the Save button to save the calibration. Press the Cancel button to terminate the calibration.

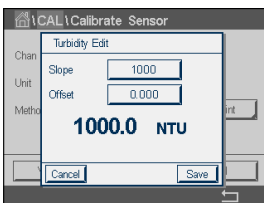

If "Save" is chosen, the message "Calibration Saved Successfully!" is displayed. After pressing the Done button the M800 returns to the Menu Screen.

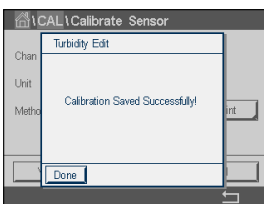

7.13 Turbidity Calibration (InPro8600i)

Enter the menu Calibrate Sensor (see chapter 7.1 "Sensor Calibration";
PATH: \Cal\Calibrate Sensor).

The following menus can be called up:

Unit: Several units for Turbidity can be chosen.

Method: Select Process calibration.

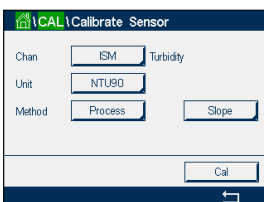

7.13.1 Process Calibration

Select calibration procedure Process (see chapter 7.13 “Turbidity Calibration (InPro8600i)”). A process calibration is performed as a slope or offset calibration.

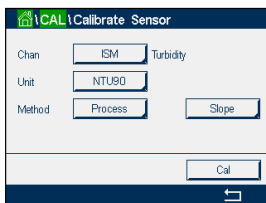

Press the Cal button for starting calibration.

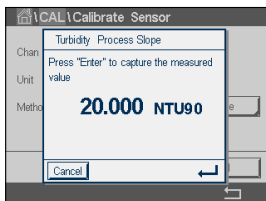

Take a sample and press the \leftarrow button to store the current measuring value. To show the ongoing calibration process, P is blinking in the Start and Menu screen if the related channel is selected in the display.



After determining the turbidity value of the sample, press the calibration icon in the Menu Screen (see chapter 3.4.2.1 “Enter the Main Menus”) again.

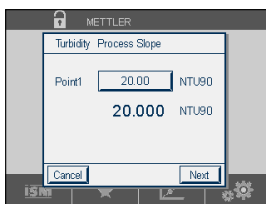

Press the input field for **Point1** and enter the turbidity value of the sample. Press the Next button to start the calculation of the calibration results.

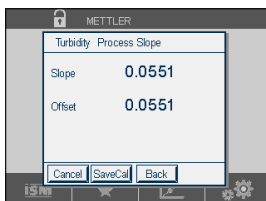

The display shows the value for the slope and the offset as the result of the calibration.

Press the SaveCal button to save the calibration. Press the Cancel button to terminate the calibration. Use the Back button to go one step back in the calibration procedure.



If “SaveCal” is chosen, the message “Calibration Saved Successfully!” is displayed. After pressing the Done button the M800 returns to the Menu Screen.

7.14 Sensor Verification

Enter the menu Calibrate Sensor (see chapter 7.1 "Sensor Calibration";
 PATH: \ Cal \ Calibrate Sensor) and choose the desired channel for verification

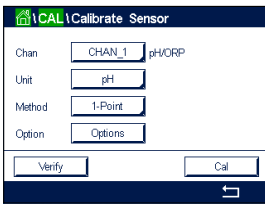

Press the Verify button to start verification.

The measured signal of the primary and the secondary measurement in basic (mostly electrical) units are shown. The meter calibration factors are used when calculating these values.

Press the button and the transmitter returns to the calibration menu.

7.15 Edit Calibration Constants for Flow Sensors

This function is the most commonly used calibration method for flow sensors

Enter the menu Calibrate Sensor (see chapter 7.1 "Sensor Calibration";
 PATH: \ Cal \ Calibrate Sensor) and choose the desired channel.

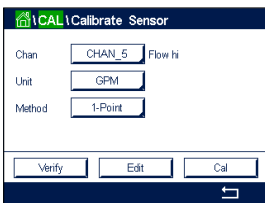

Press the Edit button.

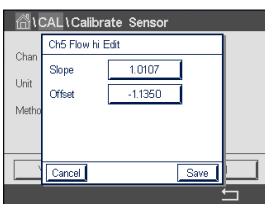

Press the input field for **Slope** to modify the slope value. The M800 displays a keypad for modifying the value. Press the button to accept the value.

Press the input field for **Offset** to modify the offset value. The M800 displays a keypad for modifying the value. Press the button to accept the value.

Selecting Cancel will discard the entered values and the M800 will return to the calibration menu.

Press Save to save the calibration factors.

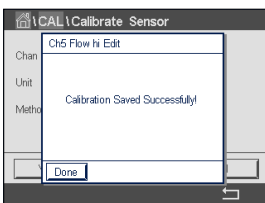

If "Save" is chosen "Calibration Saved Successfully" and "Please re-install sensor" is displayed. After pressing the Done button the M800 returns to the calibration menu.

Exit Menu Calibrate Sensor.

Press . To return to the Menu Screen press .

7.16 UniCond2e Electronics Calibration

The M800 provides the ability to calibrate or verify the electronic circuits of UniCond2e conductivity sensors. UniCond2e sensors have 3 resistance range circuits that require individual calibration. These measuring circuits are calibrated using the THORNTON ISM Conductivity Sensor Calibration Module part number 58 082 305 and supplied Y-connector. Before calibration, remove the sensor from the process, rinse with deionized water and allow to completely dry. Power the transmitter and sensor at least 10 minutes prior to calibration to assure stable operating temperature of the circuitry.

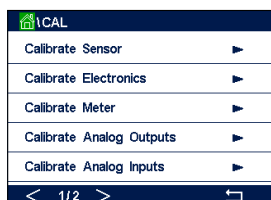

Press the Cal button.

Enter menu Calibrate Electronics.

Press the Chan_x button and select the desired channel for calibration.

Choose **Verify** or **Cal**.

Reference THORNTON ISM Conductivity Sensor Calibration Module (part number 58 082 305) for detailed calibration and verification instructions.

7.17 Meter Calibration

Although it is not normally necessary to perform meter re-calibration unless extreme conditions cause an out of spec operation shown by Calibration Verification, periodic verification/re-calibration may be necessary to meet Q.A. requirements. The frequency calibration requires a two-point calibration. It is recommended that point one be at the low end of the frequency range and point two at the high end.

Press the Cal button.

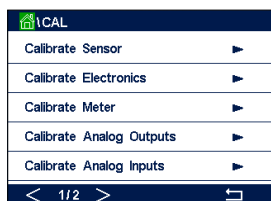

Enter menu Calibrate Meter.

7.17.1 Resistance (Analog Sensors only)

The meter is equipped with five (5) internal ranges of measurement. Each resistance range and temperature is calibrated separately, with each resistance range consisting of a two-point calibration.

Below is a table showing the resistance values for all calibration ranges.

Range	Point 1	Point 2	Point 4
Resistivity 1	1.0 Mohms	10.0 Mohms	–
Resistivity 2	100.0 Kohms	1.0 Mohms	–
Resistivity 3	10.0 Kohms	100.0 Kohms	–
Resistivity 4	1.0 Kohms	10.0 Kohms	–
Resistivity 5	100 Ohms	1.0 Kohms	–
Temperature	1000 Ohms	3.0 Kohms	66 Kohms

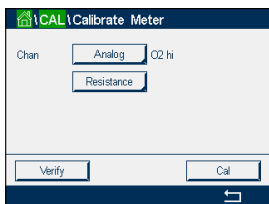

Press the input field in the second line to select Resistance.

Press the Cal button.

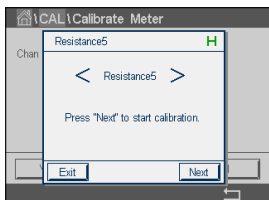

Press the Next button to start the calibration process.

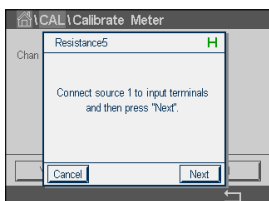

Connect source 1 to input terminals. Each resistance range consists of a two-point calibration.

Press the Next button to continue.

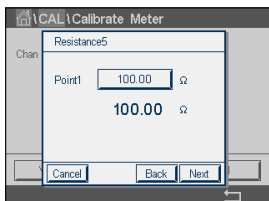

Press input field for Point1 to enter the calibration point. The M800 displays a keypad for modifying the value. Press the \leftarrow button and the transmitter will take over the value.

The second line shows the current value.

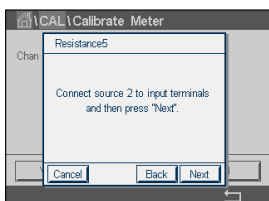

Connect source 2 to input terminals.

Press the Next button to continue.

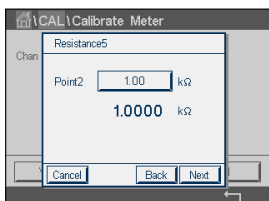

Press input field for Point2 to enter the calibration point. The M800 displays a keypad for modifying the value. Press the \leftarrow button to accept the value.

The second line shows the current value.

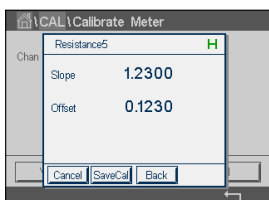

The display shows the value for the slope and the offset as the result of the calibration.

Press the SaveCal button to save the calibration. Press the Cancel button to terminate the calibration. Use the Back button to go one step back in the calibration procedure.

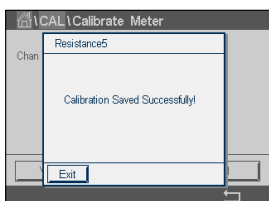

If "SaveCal" is chosen, the message "Calibration Saved Successfully!" is displayed. After pressing the Done button the M800 returns to the Menu Screen.

7.17.2 Temperature (Analog Sensors only)

Temperature is performed as a three point calibration. The table in section 7.17.1 shows the resistance values of these three points.

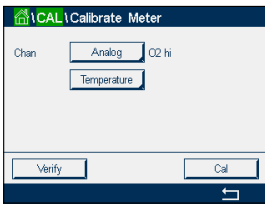

Press the input field in the second line to select Temperature.

Press the Cal button.

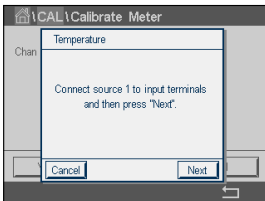

Connect source 1 to input terminals. Press the Next button to start the calibration process.

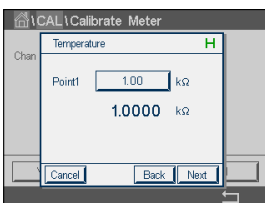

Press input field for Point1 to enter the calibration point. The M800 displays a keypad for modifying the value. Press the \leftarrow button and the transmitter will take over the value.

The second line shows the current value.

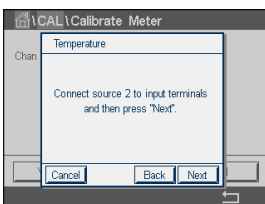

Connect source 2 to input terminals.

Press the Next button to continue.

Repeat the calibration procedure for Point2 and Point3 as for Point1.

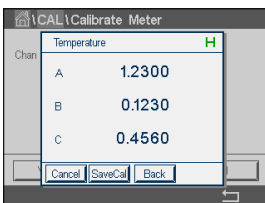

The display shows the result of the calibration.

Press the SaveCal button to save the calibration. Press the Cancel button to terminate the calibration. Use the Back button to go one step back in the calibration procedure.

If "SaveCal" is chosen, the message "Calibration Saved Successfully!" is displayed. After pressing the Done button the M800 returns to the Menu Screen.

7.17.3 Voltage

Voltage calibration is performed as a two-point calibration.

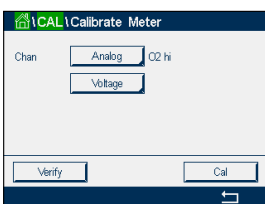

Press the input field in the second line to select Temperature.

Press the Cal button.

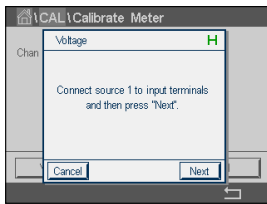

Connect source 1 to input terminals. Press the Next button to start the calibration process.

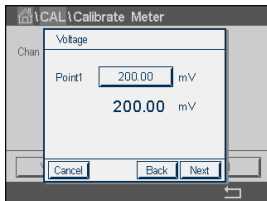

Press input field for Point1 to enter the calibration point. The M800 displays a keypad for modifying the value. Press the \leftarrow button to accept the value.

The second line shows the current value.

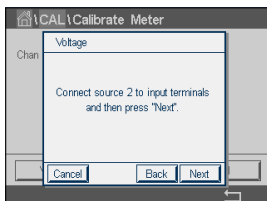

Connect source 2 to input terminals.

Press the Next button to continue.

Repeat the calibration procedure for Point2 and Point3 as for Point1.

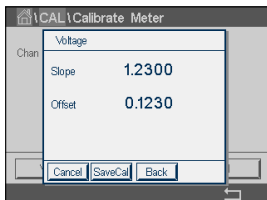

The display shows the result of the calibration.

Press the SaveCal button to save the calibration. Press the Cancel button to terminate the calibration. Use the Back button to go one step back in the calibration procedure.

If "SaveCal" is chosen, the message "Calibration Saved Successfully!" is displayed. After pressing the Done button the M800 returns to the Menu Screen.

7.17.4 Current

Current calibration is performed as a two-point calibration.

Perform current calibration according to section 7.17.3 "Voltage".

7.17.5 Rg

Rg Diagnostic calibration is performed as a two-point calibration.

Perform current calibration according to section 7.17.3 "Voltage".

7.17.6 Rr

Rr Diagnostic calibration is performed as a two-point calibration.

Perform current calibration according to section 7.17.3 "Voltage".

7.17.7 Flow meter calibration

Press the Cal button.

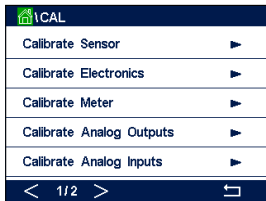

Enter menu Calibrate Meter.

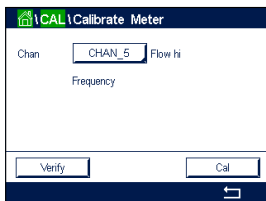

Press the Chan_x button and select the desired channel for calibration.

Press Cal to start the calibration process.

Connect a frequency generator to the xIN and xGND terminals and press Next.

Adjust the frequency generator to the first calibration point and press Next.

Press the input field for **Point1** and enter the value for the calibration point. The M800 displays a keypad for modifying the value. Press \leftarrow to accept the value.



NOTE: To select another unit for the entered value on the keypad press the U button, to return to the keypad press 0–9.

Press Next

Adjust the frequency generator to the second calibration point and press Next.

Press the input field for **Point2** and enter the value for the second calibration point. The M800 displays a keypad for modifying the value. Press \leftarrow to accept the value.

The display shows the slope and offset values as the result of the calibration.

SaveCal: Save new calibration values and store in the calibration history

Cancel: Cancel the calibration procedure and return to Calibrate Sensor Menu.

Back: Go one step back in the calibration procedure.

Press Done to return to Calibrate menu.

7.18 Flow Meter Verification

Enter Calibration Mode as described in chapter 7 "Calibration".

Enter menu Calibrate Meter.

Press the Chan_x button and select the desired channel for calibration.

Press Verify to start the verification process.

Connect a frequency generator to xIN and xGND and press Next.

The measured frequency is displayed.

Press ← to return to the calibration menu.

7.19 Analog Output Calibration

PATH:  \ CAL \ Calibrate Analog Outputs

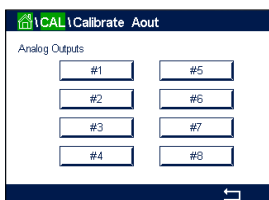

Each analog output can be calibrated at 4 and 20 mA. Select the desired output signal for calibration by pressing the #1 button for output signal 1, #2 for output signal 2, etc.

Connect an accurate milliamp meter to the analog output terminals and then adjust the 5-digit number in the display until the milliamp meter reads 4.00 mA and repeat for 20.00 mA.

As the 5-digit number is increased the output current increases and as the number is decreased the output current decreases. Thus coarse changes in the output current can be made by changing the thousands or hundreds digits and fine changes can be made by changing the tens or ones digits.

After adjusting both values press the Next button to start the calculation of the calibration results.

The display shows the calibration slope and zero point as the result of the output signal calibration.

Selecting Cancel will discard the entered values. Pressing SaveCal will making the entered values the current ones.

If "SaveCal" is chosen, "Calibration Saved Successfully" is displayed.

7.20 Analog Input Calibration

PATH:  \ CAL \ Calibrate Analog Inputs

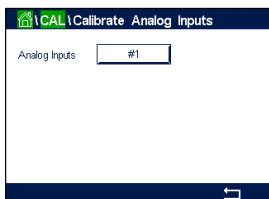

Each analog input can be calibrated at 4 and 20 mA. Select the input signal for calibration by pressing the #1 button.

Connect an 4 mA signal to the analog input terminals. Press the Next button.

Enter the right value for the input signal (**Point1**).

Press the Next button to go on with the calibration.

Connect an 20 mA signal to the analog input terminals. Press the Next button.

Enter the right value for the input signal (**Point2**).

Press the Next button to go on with the calibration.

The display shows the calibration slope and zero point as the result of the input signal calibration.

Selecting Cancel will discard the entered values. Pressing SaveCal will making the entered values the current ones.

If "SaveCal" is chosen, "Calibration Saved Successfully" is displayed.

7.21 Maintenance

PATH:  \ CAL \ Maintenance

The different channels of the M800 Transmitter can be switched manually into HOLD state. Furthermore a cleaning cycle can be started / stopped manually.

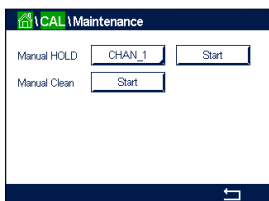

Select the channel, which should be set to HOLD manually.

Press Start button for **Manual HOLD** to activate the HOLD state for the selected channel. To deactivate the HOLD state again, press the Stop button, which is now displayed instead of the Start button.

Press the Start button for **Manual Clean** to switch the cleaning relay to the state for starting a cleaning cycle. To switch back the relay press the Stop button, which is now displayed instead of the Start button.

8 Configuration

For the menu structure refer to chapter 3.4.1 "Menu Structure".

8.1 Measurement

PATH:  \ CONFIG \ Meas

8.1.1 Channel Setup

PATH:  \ CONFIG \ Meas \ Channel Setup

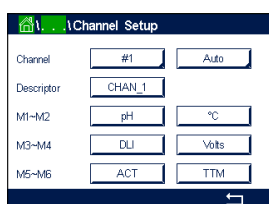

Select the **Channel** for the setup through pressing the button #1 for channel 1, #2 for channel 2 etc.

Press the right input field in the line of the setting for **Channel**. A parameter for the corresponding channel is chosen through pressing the according field.

If Auto is selected, M800 Transmitter automatically recognizes the type of sensor. The channel can also be fixed to a certain measurement parameter, depending on the type of transmitter.

Measurement parameter 2-channel and 4-channel versions

Measurement parameter		Type
pH/ORP	= pH and ORP	Water, Process
pH/pNa	= pH and ORP (with pH/pNa electrode)	Process
UniCond2e	= 2 electrode conductivity	Water, Process
UniCond4e	= 4 electrode conductivity	Water, Process
Cond4e	= 4 electrode conductivity	Water, Process
O ₂ hi	= Dissolved oxygen or oxygen in gas (ppm)	Process
O ₂ lo	= Dissolved oxygen or oxygen in gas (ppb)	Process
O ₂ Trace	= Dissolved oxygen or oxygen in gas	Process
O ₂ Opt	= Dissolved oxygen optical	Process
O ₂ lo THORNTON	= Dissolved oxygen	Water
CO ₂	= Dissolved carbon dioxide	Process
CO ₂ hi	= Dissolved carbon dioxide for beverages	Process
TOC	= Total organic carbon	Water
O ₃	= Dissolved O ₃	Water
Flow hi, low, Type2	= Flow	Water

Measurement parameter 1-channel version, analog sensors

Measurement parameter

pH/ORP	= pH and ORP
Cond2e	= 2 electrode conductivity
Cond4e	= 4 electrode conductivity
O ₂ hi	= Dissolved oxygen or oxygen in gas (ppm)
Turbidity	= Turbidity

Measurement parameter 1-channel version, ISM sensors

Measurement parameter

pH/ORP	= pH and ORP
pH/pNa	= pH and ORP (with pH/pNa electrode)
UniCond2e	= 2 electrode conductivity
UniCond4e	= 4 electrode conductivity
Cond4e	= 4 electrode conductivity
O ₂ hi	= Dissolved oxygen or oxygen in gas (ppm)
O ₂ lo	= Dissolved oxygen or oxygen in gas (ppb)
O ₂ Trace	= Dissolved oxygen or oxygen in gas
O ₂ Opt	= Dissolved oxygen optical
CO ₂	= Dissolved carbon dioxide
CO ₂ hi	= Dissolved carbon dioxide
Turbidity	= Turbidity

Enter the name with a maximum length of 6 characters for the channel through pressing the input field in the line **Descriptor**. The name of the channel will always be displayed, if the channel has to be selected. The name will also be displayed on the Start Screen and Menu Screen if the Display Mode (see chapter 8.1.3 "Display Mode") has been set to 1-Channel or 2-Channel.

Choose one of the measurements **M1 to M6** (e.g. for measuring value M1 the left button, for measuring M2 the right button in the corresponding line).

Select in the input field for **Measurement** the desired parameter to show.



NOTE: Beside the parameters pH, O₂, T, etc. also the ISM values DLI, TTM and ACT can be linked to the measurements.

Choose **Range factor** of the measuring value. Not all parameters allow a modification of the range.

The menu **Resolution** allows the setting of the resolution for the measurement. The accuracy of the measurement is not effected by this setting. Possible setting are 1, 0.1, 0.01, 0.001.

Selected the menu **Filter**. The averaging method (noise filter) for the measurement can be selected. The options are None (default), Low, Medium, High and Special.

None	= no averaging or filtering
Low	= equivalent to a 3 point moving average
Medium	= equivalent to a 6 point moving average
High	= equivalent to a 10 point moving average
Special	= averaging depending on signal change (normally High averaging, but Low averaging for large changes in input signal)

8.1.2 Derived Measurements

The M800 enables the setup of derived measurements (total, difference, ratio) based on two measuring values like pH, conductivity, etc. To get the derived measurements, first set up the two primary measurements, which will be used to calculate the derived measurement. Define the primary measurements as if they were stand-alone readings. Then choose the corresponding unit for the derived measurement for the first channel. The M800 Transmitter will display an additional menu **Other Channel** to select the second channel with the corresponding measurement.

There are three additional derived measurements available for configuration with two conductivity sensors: %Rej (% Rejection), pH Cal (Calculated pH) and CO₂ Cal (Calculated CO₂).

8.1.2.1 % Rejection measurement

For reverse osmosis (RO) applications, percent rejection is measured with conductivity to determine the ratio of impurities removed from product or permeate water to the total impurities in the incoming feed water. The formula for obtaining Percent Rejection is:

$$[1 - (\text{Product}/\text{Feed})] \times 100 = \% \text{ Rejection}$$

Where Product and Feed are the conductivity values measured by the respective sensors.

Figure a shows a diagram of an RO installation with sensors installed for Percent Rejection.

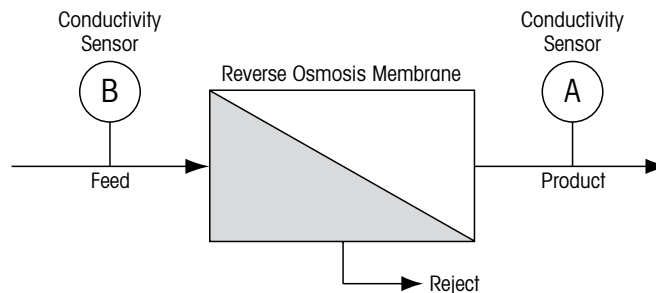

Figure a: % Rejection



NOTE: The product monitoring sensor must be on the channel that will measure percent rejection. If the product conductivity sensor is installed in channel 1, then percent rejection must be measured in channel 1.

8.1.2.2 Calculated pH (Power Plant Applications only)

Calculated pH may be obtained very accurately from specific and cation conductivity values on power plant samples when the pH is between 7.5 and 10.5 due to ammonia or amines and when the specific conductivity is significantly greater than the cation conductivity. This calculation is not suitable where significant levels of phosphates are present. The M800 uses this algorithm when pH Cal is selected as a measurement.

The calculated pH must be configured on the same channel as specific conductivity. For example, set up measurement M1 on CHAN_1 to be specific conductivity, measurement M1 on CHAN_2 to be cation conductivity, measurement M2 on CHAN_1 to be calculated pH and measurement M3 on CHAN_1 to be temperature. Set the temperature compensation mode to "Ammonia" for measurement M1 on CHAN_1 and to "Cation" for measurement M1 on CHAN_2.



NOTE: If operation goes outside the recommended conditions, a glass electrode pH measurement is needed to obtain an accurate value. On the other hand, when sample conditions are within the ranges noted above, the calculated pH provides an accurate standard for one-point trim calibration of the electrode pH measurement.

8.1.2.3 Calculated CO₂ (Power plant applications only)

Carbon dioxide may be calculated from cation conductivity and degassed cation conductivity measurements on power plant samples using tables from ASTM Standard D4519. The M800 has these tables stored in memory, which it uses when units of CO₂ CAL are selected.

The calculated CO₂ measurement must be configured to the same channel as cation conductivity. For example, set up measurement M1 on CHAN_1 to be cation conductivity, measurement M1 on CHAN_2 to be degassed cation conductivity, measurement M2 on CHAN_1 to be calculated CO₂ and measurement M2 on CHAN_2 to be temperature. Set the temperature compensation mode to "Cation" for both conductivity measurements.

8.1.3 Display Mode

PATH:  \ CONFIG \ Meas \ Display Mode

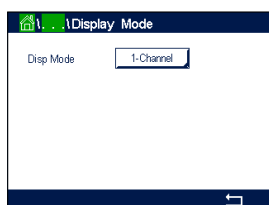

Press the input field in the line of the setting for **Disp Mode** and choose the measuring values, which are displayed on the Start Screen and Menu Screen.

Choose between the display of the measuring values for 1-Channel, the measuring values for 2-Channel, 4 measuring values (4-meas) or 8 measuring values (8-meas).

NOTE: If 1-Channel or 2-Channel has been chosen the measuring values, that will be displayed are defined in the menu Channel Setup (see chapter 8.1.1 "Channel Setup"). If 1-Channel has been chosen, M1 to M4 of every channel will be displayed. In case of 2-Channel M1 and M2 of every channel will be displayed.

Additional settings can be done if 4-meas or 8-meas has been selected.

Select the **Page** of the Start Screen or Menu Screen the measuring value will be displayed.

Choose the **Line** of the according page the measuring value will be displayed.

Select the **Channel** which should be displayed in the according line of the page through pressing the corresponding field.

Choose the measured value of the selected channel which should be displayed through the parameter **Measure**.



NOTE: Beside the measurement values pH, O₂, T, etc. also the ISM values DLI, TTM and ACT can be displayed.

8.1.4 Parameter related Settings

PATH:  \ CONFIG \ Meas \ Parameter Setting

Measuring and calibration parameters can be set for the parameters pH, conductivity, oxygen, and flow

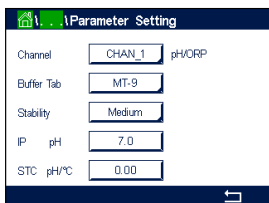

Access the menu **Channel** and select the channel.

Depending on the selected channel and assigned sensor the measuring and calibration parameters are displayed.

See the following explanation to get more details about the different parameter settings.

8.1.4.1 Conductivity Settings

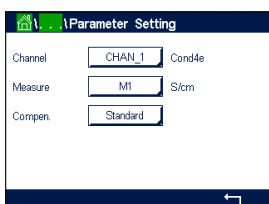

Select measurement (M1-M6). For more information regarding measurements see chapter 8.1.1 "Channel Setup".

If the selected measurement can be temperature compensated, the compensation method may be selected.



NOTE: During calibration, the compensation method must also be selected. (see chapter 7.2 "Calibration of UniCond2e and UniCond4e Sensors (ISM Sensors only)" and chapter 7.3 "Calibration of Cond2e Sensors or Cond4e Sensors").

Press **Compen.** to select the desired temperature compensation method. Choices are "None", "Standard", "Light 84", "Std 75 °C", "Linear 25°C", "Linear 20°C", "Glycol.5", "Glycol1", "Cation", "Alcohol" and "Ammonia".

None does not make any compensation of the measured conductivity value. The uncompensated value will be displayed and proceeded.

Standard compensation includes compensation for non-linear high purity effects as well as conventional neutral salt impurities and conforms to ASTM standards D1125 and D5391.

Light 84 compensation matches the high purity water research results of Dr. T.S. Light published in 1984. Use only if your institution has standardized on that work.

Std 75 °C compensation is the Standard compensation algorithm referenced to 75 °C. This compensation may be preferred when measuring Ultrapure Water at an elevated temperature (Resistivity of ultrapure water compensated to 75 °C is 2.4818 Mohm-cm.)

Linear 25 °C compensation adjusts the reading by a coefficient or factor expressed as %/°C (deviation from 25 °C). Use only if the solution has a well-characterized linear temperature coefficient. The factory default setting is 2.0%/°C.

Linear 20 °C compensation adjusts the reading by a coefficient or factor expressed as %/°C (deviation from 20 °C). Use only if the solution has a well-characterized linear temperature coefficient. The factory default setting is 2.0%/°C.

Glycol.5 compensation matches the temperature characteristics of 50% ethylene glycol in water. Compensated measurements using this solution may go above 18 Mohm-cm.

Glycol1 compensation matches the temperature characteristics of 100% ethylene glycol. Compensated measurements may go well above 18 Mohm-cm.

Cation compensation is used in power industry applications measuring the sample after a cation exchanger. It takes into account the effects of temperature on the dissociation of pure water in the presence of acids.

Alcohol compensation provides for the temperature characteristics of a 75% solution of isopropyl alcohol in pure water. Compensated measurements using this solution may go above 18 Mohm-cm.

Ammonia compensation is used in power industry applications for specific conductivity measured on samples using ammonia and/or ETA (ethanolamine) water treatment. It takes into account the effects of temperature on the dissociation of pure water in the presence of these bases.



NOTE: If compensation mode "Linear 25 °C" or "Linear 20 °C" has been chosen, the coefficient for the adjustment of the reading can be modified. In this case an additional input field will be displayed.

Press the input field for **Coef.** and adjust the coefficient or factor for the compensation.

8.1.4.2 pH Settings

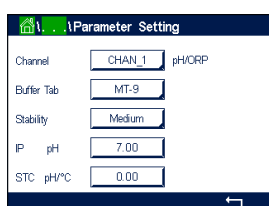

If a pH sensor is connected to the selected channel while during the channel setup (see chapter 8.1.1 "Channel Setup") Auto has been chosen the parameters Buffer Tab, Stability, IP, STC and calibration temperature as well as the displayed units for slope and/or zero point can be set or adjusted. The same parameters will be displayed if during the channel setup not Auto but pH/ORP has been set.

Select the buffer through the parameter **Buffer Tab**.

For automatic buffer recognition during calibration, select the buffer solution set that will be used: Mettler-9, Mettler-10, NIST Tech, NIST Std = JIS Std, HACH, CIBA, MERCK, WTW, JIS Z 8802 or None. See 17 "Buffer tables" for buffer values. If the auto buffer feature will not be used or if the available buffers are different from those above, select None.



NOTE: For dual membrane pH electrodes (pH/pNa) buffer Na+ 3.9M (see chapter 17.2.1 "Mettler-pH/pNa buffers (Na+ 3.9M)").

Select the required **Stability** of the measuring signal during the calibration procedure. Choose manual if the user will decide when a signal is stable enough to complete the calibration. Select Low, Medium or Strict if an automatic stability control of the sensor signal during calibration through the transmitter should be done.

If the parameter stability is set to medium (default) the signal deviation has to be less than 0.8 mV over a 20 second interval to be recognized by the transmitter as stable. The calibration is done using the last reading. If the criteria is not met within 300 seconds then the calibration times out and the message "Calibration Not Done" is displayed.

Adjust the parameter **IP pH**.

IP is the isothermal point value (Default = 7.000 for most applications). For specific compensation requirements or non standard inner buffer value, this value can be changed.

Adjust the value of the parameter **STC pH/°C**.

STC is the solution temperature coefficient in units of pH/°C referenced to the defined temperature. (Default = 0.000 pH/°C for most applications). For pure waters, a setting of -0.016 pH/°C should be used. For low conductivity power plant samples near 9 pH, a setting of -0.033 pH/°C should be used.

If the value for STC is \neq 0.000 pH/°C an additional input field for the reference temperature will be displayed.

The value for **pH Ref Temperature** indicates to which temperature the solution temperature compensation is referenced. The displayed value and the output signal is referenced to this temperature. Most common reference temperature is 25°C.

8.1.4.3 Settings for Oxygen Measurement Based on Amperometric Sensors

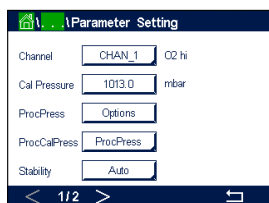

If an amperometric oxygen sensor is connected to the selected channel while during the channel setup (see chapter 8.1.1 "Channel Setup") Auto has been chosen the parameters CalPressure, ProcPressure, ProcCalPress, Stability, Salinity, RelHumidity, UpolMeas and UpolCal can be set or adjusted. The same parameters will be displayed if during the channel setup not Auto but O₂ hi, O₂ lo or O₂ trace has been set.

Enter the value for the calibration pressure through the parameter **CalPressure**.

NOTE: For a modification of the unit for the calibration pressure press U on the displayed keypad.

Press the Option button for the parameter **ProcPressure** and select the how to get applying process pressure through choosing the **Type**.

The applied process pressure can be entered by choosing Edit or measured over the analog input of the M800 by choosing Ain_1.

If Edit has been chosen an input field for entering the value manually is displayed on the screen. In case that Ain_1 has been selected two input fields are displayed to enter the start value (4 mA) and the end value (20 mA) of the range for the 4 to 20 mA input signal.

For the algorithm of the process calibration the applied pressure has to be defined. Select the pressure through the parameter **ProcCalPress**. For the process calibration the value of the process pressure (ProcPress) or the calibration pressure (CalPress) can be used.

Select the required **Stability** of the measuring signal during the calibration procedure. Choose Manual if the user will decide when a signal is stable enough to complete the calibration. Select Auto and an automatic stability control of the sensor signal during calibration through the transmitter will be done.

Additional settings can be done by navigating to the next page of the menu.

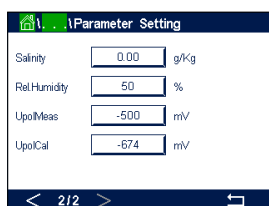

The **Salinity** of the measured solution can be modified.

In addition the relative humidity (button **Rel.Humidity**) of the calibration gas can also be entered. The allowed values for relative humidity are in the range 0% to 100%. When no humidity measurement is available, use 50% (default value).

The polarization voltage of amperometric oxygen sensors in the measuring mode can be modified through the parameter **UpolMeas**. For entered values 0 mV to -550 mV the connected sensor will be set to a polarization voltage of -500mV. If the entered value is less then -550 mV, the connected sensor will set to a polarization voltage of -674 mV.

The polarization voltage of amperometric oxygen sensors for calibration can be modified through the parameter **UpolCal**. For entered values 0 mV to -550 mV the connected sensor will be set to a polarization voltage of -500mV. If the entered value is less then -550mV, the connected sensor will set to a polarization voltage of -674mV.

NOTE: During a process calibration, the polarization voltage UpolMeas, defined for the measuring mode, will be used.



NOTE: If a one-point calibration is executed, the transmitter sends the polarization voltage, valid for the calibration, to the sensor. If the polarization voltage for the measuring mode and calibration mode is different, the transmitter will wait 120 seconds before starting the calibration. In this case the transmitter will also go after the calibration for 120 seconds to the HOLD Mode, before returning to the measuring mode again.

8.1.4.4 Settings for Oxygen Measurement Based on Optical Sensors

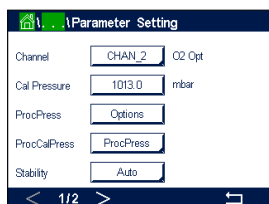

If an optical oxygen sensor is connected to the selected channel while during the channel setup (see chapter 8.1.1 "Channel Setup") Auto has been chosen the parameters CalPressure, ProcPressure, ProcCalPress, Stability, Salinity, RelHumidity, Sample Rate, LED Mode and Toff can be set or adjusted. The same parameters will be displayed if during the channel setup not Auto but Optical O₂ has been set.

Enter the value for the calibration pressure through the parameter **CalPressure**.

Press the button Option for the parameter **ProcPress** and select the how to get applying process pressure through pressing the according button in the line **Type**.

The applied process pressure can be entered by choosing Edit or measured over the analog input of the M800 by choosing AIN_1.

If Edit has been chosen an input field for entering the value manually is displayed on the screen. In case that AIN_1 has been selected two input fields are displayed to enter the start value (4mA) and the end value (20 mA) of the range for the 4 to 20 mA input signal.

For the algorithm of the process calibration the applied pressure has to be defined. Select the pressure through the parameter **ProcCal**. For the process calibration the value of the process pressure (ProcPress) and the value of the calibration pressure (CalPress) can be used. Select between Scaling and Calibration for the process calibration. If Scaling has been chosen, the calibration curve of the sensor will be untouched, but the output signal of the sensor will be scaled. In case of calibration value <1%, the offset of the sensor output signal will be modified during scaling, for value >1% the slope of the sensor output will be adjusted. For further information about scaling refer to the sensor manual.

Selecting the required **Stability** of the measuring signal during the calibration procedure. Choose Manual if the user will decide when a signal is stable enough to complete the calibration. Select Auto and an automatic stability control of the sensor signal during calibration through the transmitter will be done.

Additional settings can be done by navigating to the next page of the menu.

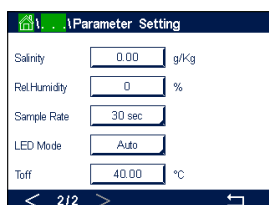

The **Salinity** of the measured solution can be modified.

In addition the relative humidity (button **Rel.Humidity**) of the calibration gas can also be entered. The allowed values for relative humidity are in the range 0% to 100%. When no humidity measurement is available, use 50% (default value).

Adjust the required **Sample Rate** of the optical sensor during measurement. The time interval from one measuring cycle of the sensor to the next can be adjusted i.e. adapted to the application. A higher value will increase the life time of the OptoCap of the sensor.

Select the **LED Mode** of the sensor. There are the following options.

Off: LED is permanently switched off.

On: LED is permanently switched on.

Auto: The LED is switched on as long as the measured media temperature is smaller then Toff (see next value) or switched off through a digital input signal (see chapter 8.10 "Digital Inputs").



NOTE: If the LED is switched off, no oxygen measurement is performed.

Enter the limit for the measuring temperature to switch off the LED of the sensor automatically for the M800 through the parameter **Toff**.

If the media temperature is higher then Toff, the LED will be switched off. The LED will be switched on as soon as the media temperature falls below Toff -3 K. This function give the option to increase the lifetime of the OptoCap by switching off the LED during SIP or CIP cycles.



NOTE: This function is only active if the LED Mode is set to "Auto".

8.1.4.5 Dissolved Carbon Dioxide Settings

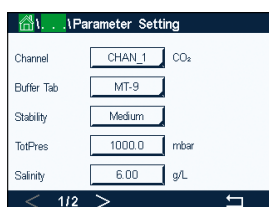

If an dissolved carbon dioxide sensor is connected to the selected channel while during the channel setup (see chapter 8.1.1 "Channel Setup") Auto or CO₂ has been chosen, the buffer used for calibration and the parameters stability, salinity, HCO₃, TotPres can be set resp. adjusted.

Select the buffer through the parameter **Buffer Tab**. For automatic buffer recognition during calibration, select buffer solution Mettler-9 if it will be used. If the auto buffer feature will not be used or if the available buffer are different from Mettler-9 select None.

Select the required **Stability** of the measuring signal during the calibration procedure. Choose manual if the user will decide when a signal is stable enough to complete the calibration. Select Low, Medium or Strict if an automatic stability control of the sensor signal during calibration through the transmitter should be done.

If the unit for the measured dissolved carbon dioxide is %sat, the pressure during the calibration resp. measurement has to be considered. This will be done by setting the parameter **TotPres**. If another unit then %sat has been selected, the result will not be influenced by this parameter.

The **Salinity** describes the total amount of solved salts in the CO₂ electrolyte of the sensor connected to the transmitter. It is a sensor specific parameter. The default value (28.00 g/L) is valid for the InPro5000i. Do not change this parameter if the InPro 5000i will be used.

Additional settings can be done by navigating to the next page of the menu.



The parameter **HCO₃** describes the concentration of hydrogen carbonate in the CO₂ electrolyte of the sensor connected to the transmitter. It is also a sensor specific parameter. The default value 0.050 Mol/L is valid for the InPro5000i. Do not change this parameter if the InPro5000i will be used.

8.1.4.6 Settings for Thermal Conductivity Dissolved CO₂ Measurement (CO₂ hi)

If during the channel setup (see chapter 8.1.1 "Channel Setup") the parameter CO₂ Hi has been chosen, the parameters stability (manual/auto) and CO₂ solubility (CO₂-solubility and Temperature Factor), be set resp. adjusted.

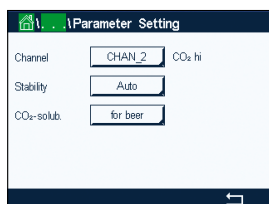

Select the required **Stability** of the measuring signal during the calibration procedure. Choose manual if the user will decide when a signal is stable enough to complete the calibration. Select Auto if an automatic stability control of the sensor signal during calibration through the transmitter should be done.

The sensor offers a choice of CO₂ **Solubility's** for measurement in beer, water and cola. The cola setting is to be used with carbonated soft drinks. For other beverages the user has the possibility to enter individual values for CO₂ solubility and temperature factors.

Default values for measurement in beer (valid for temperatures – 5 ... 50 °C):

CO₂ solubility (A): 1.420 g/L
Temp. factor (B): 2485

Values for pure water:

CO₂ solubility (A): 1.471 g/L
Temp. factor (B): 2491

Values for cola:

CO₂ solubility (A): 1.345 g/L
Temp. factor (B): 2370



NOTE: The sensor is delivered factory calibrated and is set up to measure in beer as the default.

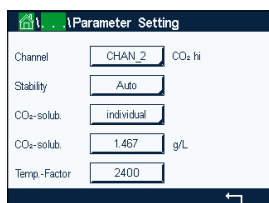

For beverages where the user knows the exact CO₂ solubility and the temperature factor the values can be changed **individually**.

If the user desires to evaluate the solubility (**CO₂-solub.**) and temperature factors (**Temp.-Factor**) they can be evaluated with the following formulas.

$$\text{HCO}_2 = A * \exp (B * (1 / T - 1 / 298.15))$$

$$c\text{CO}_2 = \text{HCO}_2 * p\text{CO}_2$$

HCO₂ : Calculated CO₂ Solubility (Henry constant) at measured process temp.

A: Solubility of CO₂ (g / L at 25 °C)

B: Temperature factor (valid for – 5 ... 50 °C)

cCO₂: Calculated CO₂ concentration in g/l or V/V

8.1.4.7 Settings for TOC Measurement

For information on how to configure parameter related settings associated with TOC measurement, refer to the 5000TOCi operating manual provided with the 5000TOCi Total Organic Carbon sensor.

8.1.4.8 Settings for Flow Measurement

For the dedicated flow channels, Pipe ID and Flow Cut can be adjusted

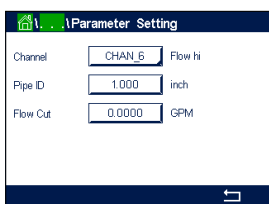

Press the input field for the value of the parameter **Pipe ID**. The M800 displays a keypad for modifying the value. Flow velocity measurements in ft/sec require the inside diameter of the pipe (in which the sensor is installed) for calculations. Enter the precise inside diameter in inches. Press \leftarrow to accept the value.

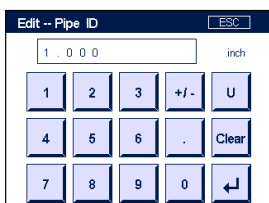

To select the low flow cutoff, select **Flow Cut**. The M800 displays a keypad for modifying the value. If the measured value is less than the entered value for Flow Cut, the M800 Transmitter sets the measured value for flow to 0. Press \leftarrow to accept the value.

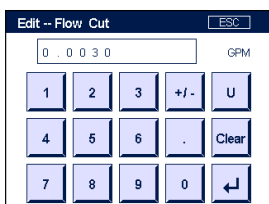

8.1.4.9 Settings for Turbidity Sensors (InPro8000 Series)

The following menus can be called up:

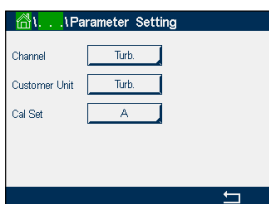

- Chanel:** Turb. for turbidity sensors (InPro8000 Series) is chosen.
- Customer unit:** Enter customer-specific unit or description with maximum 6 characters. Default is "Turb.". The entered unit is selectable in the unit measurement list in the measurement screen in the Channel Setup menu.
- Cal Set:** Select Cal Set A, B or C for current measurement calculation. In the Cal Set the calculation factors are stored. In the Digital Inputs menu you can assign a Cal Set to a digital input using the Mode and Digital Inputs parameter.

8.1.4.10 Settings for Turbidity Sensors (InPro8600i)

The following menus can be called up:

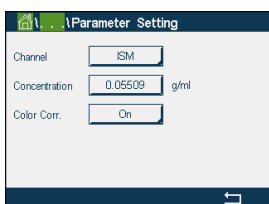

- Chanel:** ISM for turbidity sensors (InPro8600i) is chosen.
- Concentration:** Enter value for Concentration.
- Color Corr:** Activate (On) or deactivate (Off) the color correction for InPro 8600i/D3 sensors.

8.1.4.11 Deionization Capacity (DI-Cap™)

Total equivalents, ppm-gallons or grains: The M800 can monitor the flow rate and mineral concentration entering a deionization vessel and infer the extent of resin capacity consumption. By multiplying the total dissolved solids (TDS) based on conductivity times flow rate and integrating the result over time, total mineral content that has entered the deionization vessel can be monitored.

The M800 can provide this in real-time by setting measurement units to equivalents, ppm-gallons or grains. From this and knowledge of the total ion exchange capacity of the vessel, the “% of run” and/or anticipated time for next regeneration can be determined. This measurement requires installation of a flow sensor and a conductivity sensor.

To set up a deionization capacity measurement:

1. Set up the measurement for the flow sensor.
2. Set up the measurement for the conductivity sensor.
3. Set up an additional measurement for deionization capacity for the flow channel with units of equiv, ppm-G or Grains.
4. Following the path <Config/Measurement/Parameter Setting> for the flow measurement channel, select the channel of the conductivity measurement being used for the calculation and set the TDS factor appropriately for the water being measured as determined below.

Deionization capacity can be reset to zero, similar to total flow, using the path <Config/Reset/Configure/Chan X/DiCap/Reset>.

Total Dissolved Solids (TDS) may be inferred and displayed based on conductivity/resistivity data. TDS is the concentration of sodium chloride (or other conductive substance) corresponding to the measured conductivity. Salinity is the same as TDS, specifically for sodium chloride. Both are given in units of parts per billion (ppb), parts per million (ppm) or parts per thousand (ppk, as abbreviated on M800).

The default setting of 1.0 for the TDS Factor provides conversion based on the conductivity of sodium chloride at 0.462 ppm per uS/cm, with non-linear corrections at very low and very high conductivities. The TDS factor may be changed to provide accurate conversion for other compositions. It is a multiplier on the sodium chloride conversion. Values for other materials are given in the table below (normalized to NaCl). These values adjust the TDS value for the actual conductivity of the materials in the table. Different values are needed for measurements involving ion exchange calculations – see below.

Material	TDS factor
NaCl	1.0000
KCl	1.0786
CaCl ₂	0.8839
CaCO ₃	0.8407
NaOH	0.3480

Total Dissolved Solids for ion exchange calculations are based on the conductivity and weight of the materials present expressed as their ion exchange equivalent as calcium carbonate. For a defined composition of neutral minerals with conductivity the same as sodium chloride, a TDS factor of 0.856 will give readout as ppm NaCl expressed as CaCO₃. For conditions of strong base exchange, a TDS factor of 0.435 will give readout as ppm NaOH expressed as CaCO₃.

8.1.5 Concentration Curve Table

To specify a concentration curve for customer-specific solutions, up to 5 concentration values can be edited in a matrix together with up to 5 temperatures. To do so the desired values are edited under the concentration curve table menu. Beside the temperature values, the conductivity and concentration values for the corresponding temperature are edited. The concentration curve can be selected resp. used in combination with conductivity sensors.

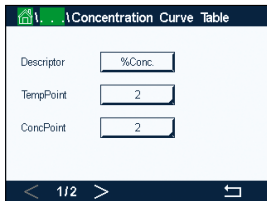

Enter the name with a maximum length of 6 characters for the concentration curve through pressing the input field in the line **Descriptor**.

Enter the amount of desired temperature points (**TempPoint**) and concentration points (**ConcPoint**).

The different values can be entered by navigating to the next page of the menu.

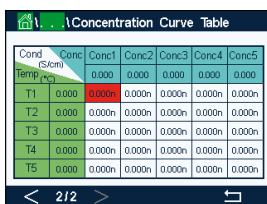

Enter the values for temperature (**T1...T5**), concentration (**Conc1...Conc5**) and the corresponding conductivity through pressing the according input field. The unit for the value of the conductivity can be adjusted as well in the according input field.



NOTE: The values for the temperature have to increase from T1 to T2 to T3, etc. The values for the concentration have to increase from Conc 1 to Conc2 to Conc3, etc.



NOTE: The conductivity values at the different temperatures have to increase or decrease from Conc1 to Conc2 to Conc3, etc. Maxima and/or minima are not permitted. If the conductivity values at T1 are increasing with the different concentrations, they have to increase also at the other temperatures. If the conductivity values at T1 are decreasing with the different concentrations, they have to decrease also at the other temperatures.

8.2 Temperature Source (Analog Sensors only)

PATH: \ CONFIG \ Meas \ Temperature Source

Source: Auto(default), Pf100, Pf1000, NTC22K, Fixed

The third line shows the related temperature setting. Range: -40 to 200 °C, Default: 25 °C

8.3 Analog Outputs

PATH:  \ CONFIG \ Analog Outputs

See the following explanation to get more details about the different settings for the analog outputs.

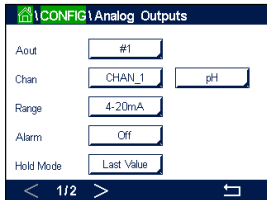

Press the input field in the line of the setting for **Aout** and select the desired output signal for configuration by pressing button #1 for output signal 1, #2 for output signal 2 etc. Press the related button for the assignment of the channel (**Chan**). Select the channel, which has to be linked to the output signal.

Press the button for the assignment of the measuring parameter – based on the selected channel – that has to be linked to the output signal.



NOTE: Besides the measurement values pH, O₂, T, etc. also the ISM values DLI, TTM and ACT can be linked to the output signal.

Select the **Range** for the output signal.

To adjust the value for the analog output signal if an alarm occurs, press the input field in the line for the setting of **Alarm**. Off means, that an alarm has now influence on the output signal.



NOTE: Not only the alarms occurred on the assigned channel will be considered, but every alarm coming up on the transmitter.

The value for the output signal if the transmitter goes into HOLD mode can be defined. It can be chosen between the last value (i.e. the value before the transmitter switched to the HOLD mode) or an fixed value.

Press the input field in the line for the setting of the **HOLD Mode** and select the value. If a fixed value is chosen, the transmitter shows an additional input field.

Additional settings can be done by navigating to the next page of the menu.

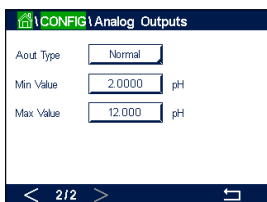

The **Aout Type** can be Normal, Bi-Linear, Auto-Range or Logarithmic. The range can be 4–20 mA or 0–20 mA. Normal provides linear scaling between the minimum and maximum scaling limits and is the default setting. Bi-Linear will also prompt for a scaling value for the mid-point of the signal and allows two different linear segments between the minimum and maximum scaling limits.

Press the button for the **Min Value**, that corresponds with start point of the analog output range.

Press the button for the **Max Value**, that corresponds with end point of the analog output signal.

Depending on the chosen Aout type additional values can be entered.

Bi-Linear will also prompt for a scaling value for the Mid Value of the signal and allows two different linear segments between the defined Min and Max Values.

Auto-Range scaling provides two ranges of output. It is designed to work with a PLC to provide a wide measurement range at the high end of the scale, and a narrower range with high resolution at the low end. Two separate settings are used, one for the maximum limit of the high range and one for the maximum limit of the low range, for the single 0/4-20 mA signal.

Max1 is the maximum limit of the low range on auto-range. The maximum value for the high range on auto-range is set with the Max Value. Both ranges have the same minimum value that is set through Min Value. If the input value is higher than value of Max1, the transmitter switches automatically to the second range. To indicate the currently valid range a relay can be assigned. The relay will be switched if the transmitter changes from on range to the other.

If **Logarithmic** Range was selected, it will prompt for the Max Value and also for the number of decades.

8.4 Set Points

PATH:  \ CONFIG \ Set Points

See the following explanation to get more details about the different settings for the set points.



Press the input field in the line of the setting for **Set Point** and select the desired set point for configuration through pressing the button #1 for set point 1, #2 for set point 2 etc..

Press the related button for the assignment of the channel (**Chan**). Select the channel, which has to be linked to the set point.

Press the button for the assignment of the measuring parameter – based on the selected channel – that has to be linked to the set point.

Mx in the display indicates the measurement assigned to the set point. (see chapter 8.1.1 “Channel Setup”).



NOTE: Beside the parameters pH, O₂, T, mS/cm, %EP WFI etc. also the ISM values DLI, TTM and ACT can be linked to the set point.

The **Type** of the setpoint can be High, Low, Between, Outside or Off. An “Outside” setpoint will cause an alarm condition whenever the measurement goes above its high limit or below its low limit. A “Between” setpoint will cause an alarm condition to occur whenever the measurement is between its high and low limits.



NOTE: If the type of set point is not Off additional settings can be done. See the following description.

According to the selected type of setpoint, value(s) regarding the limit(s) can be entered.

Additional settings can be done by navigating to the next page of the menu.

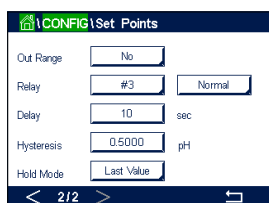

Once configured a relay could be activated if a sensor **Out of Range** condition is detected on the assigned input channel.

To select the desired relay that will be activated if the defined conditions are reached press the input field in the line for the setting of **SP Relay**. If the chosen relay is used for another task, the transmitter shows the message on the screen that there is a Relay Conflict.

The operation mode of the relay can be defined.

Relay contacts are in normal mode until the associated setpoint is exceeded, then the relay is activated and the contact states change. Select Inverted to reverse the normal operating state of the relay (i.e. normally open contacts are in a closed state, and normally closed contacts are in an open state, until the setpoint is exceeded).

Enter the **Delay** time in seconds. A time delay requires the setpoint to be exceeded continuously for the specified length of time before activating the relay. If the condition disappears before the delay period is over, the relay will not be activated.

Enter the value for the **Hysteresis**. A hysteresis value requires the measurement to return within the setpoint value by a specified percentage before the relay is deactivated.

For a high setpoint, the measurement must decrease more than the indicated percentage below the setpoint value before the relay is deactivated. With a low setpoint, the measurement must rise at least this percentage above the setpoint value before the relay is deactivated. For example, with a high setpoint of 100, when this value is exceeded, the measurement must fall below 90 before the relay is deactivated.

Enter the relay **HOLD Mode** of "Off", "Last Value" or "On". This is the state of the relay during HOLD status.

8.5 ISM Setup (ISM Sensors only)

PATH:  \ CONFIG \ ISM Setup

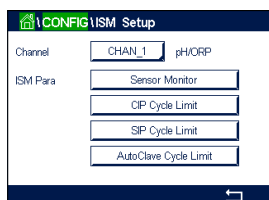

See the following explanation to get more details about the different parameter settings for the ISM Setup.

8.5.1 Sensor Monitor

If a pH/ORP, O₂ hi, O₂ lo, O₂ trace, O₃ or O₂ optical sensor is connected to the selected channel while during the channel setup (see 8.1.1 "Channel Setup") Auto has been chosen the parameter Sensor Monitor can be set or adjusted. The menu Sensor Monitor will also be displayed if during the channel setup not Auto but one of the mentioned sensors has been set.

Press the button Sensor Monitor.

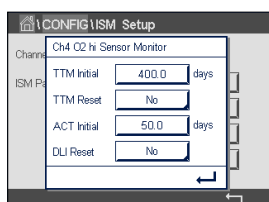

Enter the value for the initial Time To Maintenance interval (**TTM Initial**) in days. The initial value for TTM can be modified according to the application experience.

For pH/ORP sensor the timer estimates when the next cleaning cycle should be performed to keep the best possible measurement performance. The timer is influenced by significant changes on the DLI parameters.

For amperometric oxygen and ozone sensors, the time to maintenance indicates a maintenance cycle for the membrane and electrolyte.

Press the input field for **TTM Reset**. Select Yes if Time To Maintenance (TTM) for the sensor should be reset to the initial value.

Time To Maintenance needs to be reset after the following operations.

pH sensors: manual maintenance cycle on the sensor.
 Oxygen or ozone sensor: manual maintenance cycle on the sensor or exchanging of the membrane of the sensor



NOTE: The menu TTM Initial and TTM Reset is for O₂ optical sensors not available.



NOTE: By connecting a sensor, the actual value for TTM of the sensor is read out from the sensor.

Enter the **ACT Initial** value in days. The new value will be loaded down to the sensor after saving the changes.

The Adaptive Calibration Timer (ACT) estimates when the next calibration should be performed to keep the best possible measurement performance. The timer is influenced by significant changes on the DLI parameters. The ACT will be reset to its initial value after a successful calibration. The initial value for the ACT can be modified according to the application experience and loaded down to the sensor.



NOTE: By connecting a sensor, the actual value for the ACT of the sensor is read out from the sensor.

Press the input field for **DLI Reset**. Select Yes if Dynamic Lifetime Indicator (DLI) for the sensor should be reset to the initial value. The reset will be done after saving the changes.

The DLI allows an estimation, when the pH electrode, the inner body of an amperometric oxygen or ozone sensor or the OptoCap of an optical oxygen sensor is at the end of his lifetime, based on the actual stress he is exposed to. The sensor permanently takes the averaged stress of the past days into consideration and is able to increase/decrease the lifetime accordingly.

The following parameters affect the lifetime indicator:

Dynamic parameters:

- Temperature
- pH or oxygen value
- Glass impedance (only pH)
- Reference impedance (only pH)

Static parameters:

- Calibration history
- Zero and Slope
- Phase 0 and phase 100 (only optical DO)
- Illumination time (only optical DO)
- Sampling rate (only optical DO)
- CIP/SIP/Autoclaving cycles

The sensor keeps the information stored in the built in electronics and can be retrieved via a transmitter or the iSense asset management suite.

For amperometric oxygen sensors, the DLI is related to the inner-body of the sensor. After exchanging the inner-body perform DLI Reset.

For optical DO sensors the lifetime indicator is related to the OptoCap. After exchanging the OptoCap perform DLI Reset.



NOTE: By connecting a sensor, the actual values for the DLI of the sensor are read out from the sensor.



NOTE: The menu DLI Reset for pH sensors not available. If the actual value for the DLI of a pH sensor is 0 the sensor has to be replaced.

8.5.2 CIP Cycle Limit

If a pH/ORP, oxygen or conductivity sensor is connected to the selected channel during the channel setup (see chapter 8.1.1 "Channel Setup") Auto has been chosen the parameter CIP Cycle Limit can be set or adjusted. The menu CIP Cycle Limit will also be displayed if during the channel setup not Auto but one of the mentioned sensors has been set.

Press the button CIP Cycle Limit.

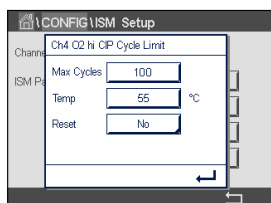

Press the button in the input field for the parameter **Max Cycles** and enter the value for the maximum CIP cycles. The new value will be written to the sensor after saving the changes.

The CIP cycles are counted by the transmitter. If the limit (value for Max Cycles) is reached, an alarm can be indicated and set to a certain output relays.

If the Max Cycles setting is on 0, the counter functionality is turned off.

NOTE: In case of an optical oxygen sensor, the value for Max Cycles will also be written to the sensor. The M800 Transmitter uploads the value Max Cycles from an optical oxygen sensor after the connection.

Press the button in the input field for the parameter **Temp** and enter the temperature, which has to be exceeded, that the a CIP cycle will be counted.

CIP Cycles will be automatically recognized by the transmitter. Since CIP cycles will vary in intensity (duration and temperature) for each application the algorithm of the counter recognizes an increase of the measurement temperature above the level defined through the value for Temp. If the temperature does not decrease below the defined temperature level -10 °C within the next 5 minutes after the first temperature was reached, the counter in question will be incremented by one and also locked for the next two hours. In the case the CIP would last longer than two hours the counter would be incremented by one once more.

Press the input field for **Reset**. Select Yes if CIP counter for the sensor should be reset to 0. The reset will be done after saving the changes.

If an oxygen sensor is connected, the reset should be performed after the following operations.
 optical sensor: exchanging of the OptoCap
 amperometric sensor: exchanging of the inner-body of the sensor.

NOTE: For pH/ORP sensor the menu Reset is not available. A pH/ORP sensor should be replaced if the number for Max Cycles has been exceeded.



8.5.3 SIP Cycle Limit

If a pH/ORP, oxygen or conductivity sensor is connected to the selected channel during the channel setup (see chapter 8.1.1 "Channel Setup") Auto has been chosen the parameter SIP Cycle Limit can be set or adjusted. The menu SIP Cycle Limit will also be displayed if during the channel setup not Auto but one of the mentioned sensors has been set.

Press the button SIP Cycle Limit.

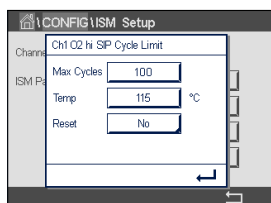

Press the button in the input field for the parameter **Max Cycles** and enter the value for the maximum SIP cycles. The new value will be written to the sensor after saving the changes.

The SIP cycles are counted by the transmitter. If the limit (value for Max Cycles) is reached, an alarm can be indicated and set to a certain output relays.

If the Max Cycles setting is on 0, the counter functionality is turned off.



NOTE: In case of an optical oxygen sensor, the value for Max Cycles will also be written to the sensor. The M800 Transmitter uploads the value Max Cycles from an optical oxygen sensor after the connection.

Press the button in the input field for the parameter **Temp** and enter the temperature, which has to be exceeded, that the a SIP cycle will be counted.

SIP Cycles will be automatically recognized by the transmitter. Since SIP cycles will vary in intensity (duration and temperature) for each application the algorithm of the counter recognizes an increase of the measurement temperature above the level defined through the value for Temp. If the temperature does not decrease below the defined temperature level - 10°C within the next 5 minutes after the first temperature was reached, the counter in question will be incremented by one and also locked for the next two hours. In the case the SIP would last longer than two hours the counter would be incremented by one once more.

Press the input field for **Reset**. Select Yes if SIP counter for the sensor should be reset to 0. The reset will be done after saving the changes.

If an oxygen sensor is connected, the reset should be performed after the following operations.
 Optical sensor: exchanging of the OptoCap
 Amperometric sensor: exchanging of the inner-body of the sensor.



NOTE: For pH/ORP sensor the menu Reset is not available. A pH/ORP sensor should be replaced if the number for Max Cycles has been exceeded.

8.5.4 AutoClave Cycle Limit

If a pH/ORP, amperometric oxygen or, depending on the model, optical oxygen sensor is connected to the selected channel during the channel setup (see chapter 8.1.1 "Channel Setup") Auto has been chosen the parameter AutoClave Cycle Limit can be set or adjusted. The menu AutoClave Cycle Limit will also be displayed if during the channel setup not Auto but one of the mentioned sensors has been set.

Press the button AutoClave Cycle Limit.

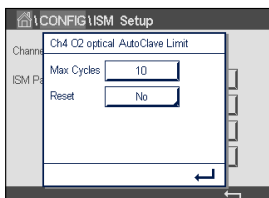

Press the button in the input field for the parameter **Max Cycles** and enter the value for the maximum AutoClave cycles. The new value will be written to the sensor after saving the changes.

If the Max Cycles setting is on 0, the counter functionality is turned off.

Since during the autoclaving cycle the sensor is not connected to the transmitter, you will be asked after every sensor connection, whether the sensor was autoclaved or not. According to your selection, the counter will be incremented or not. If the limit (value for Max Cycles) is reached, an alarm can be indicated and set to a certain output relay.



NOTE: In case of an optical oxygen sensor, the value for AutoClave Max will be written to the sensor. The M800 Transmitter uploads the value Max Cycles from an optical oxygen sensor after plugging in.

Press the input field for **Reset**. Select Yes if the AutoClave counter for the sensor should be reset to 0. The reset will be done after saving the changes.

If an oxygen sensor is connected, the reset should be performed after the following operations.
 Optical sensor: exchanging of the OptoCap
 Amperometric sensor: exchanging of the inner-body of the sensor.



NOTE: For pH/ORP sensor the menu Reset is not available. A pH/ORP sensor should be replaced if the number for Max Cycles has been exceeded.

8.5.5 DLI Stress Adjustment

If a pH/ORP is connected to the selected channel during the channel setup (see chapter 8.1.1 "Channel Setup") Auto has been chosen the parameter DLI Stress Adjustment can be adjusted. With this setting the user can adjust the sensor sensitivity to the stress of his specific application for the DLI calculation.



Browse to page 2 of "ISM Setup".

Press the button **DLI Stress Adjustment**.

Select between low / medium / high for the **Type** of DLI Stress Adjustment.

LOW: DLI extended (-30% sensitivity)
 MEDIUM: standard DLI (default)
 HIGH: DLI reduced (+30% sensitivity)

Press ← to accept the setting.

8.5.6 SAN Cycle Parameters

If an ozone sensor is connected, values for the following SAN Cycle Parameters can be set, Max Cycles (the maximum number of sanitization cycles), Conc. Max (the maximum allowed O₃ concentration), Conc. Min (the minimum allowed O₃ concentration), Cycle Time (length of cycle), and Reset.

Press the button SAN Cycle Parameters.

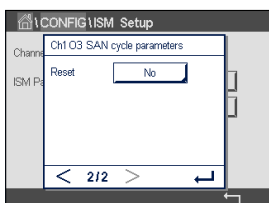

Press the input field next to Max Cycles and enter the value for the maximum SAN cycles. Press \leftarrow to accept the value. The new value will be written to the sensor after saving the changes.

The SAN cycles are counted by the transmitter. If the limit (value for Max Cycles) is reached, an alarm can be configured. If the Max Cycles setting = 0, the counter functionality is turned off.

Press the input field next to Conc. Max and enter the ozone concentration above which a sanitization cycle is to be detected. Press \leftarrow to accept the value.

Press the input field next to Conc. Min. Enter the value for the ozone concentration below which a sanitization cycle is no longer detected. Press \leftarrow to accept the value.

Press the input field next to Cycle Time. Enter the value for the time, the ozone concentration has to be higher than the Conc. Min value after the Conc. Max value has been exceeded to count a sanitization cycle. Press \leftarrow to accept the value.

Press the input field next to Reset. Select Yes to reset the sanitization counter to zero. This is typically performed after sensor replacement. The reset will be done after saving the changes.

Press \leftarrow to exit the menu SAN Cycle Parameters.

8.5.7 Reset Counters for UniCond2e Sensors

For UniCond2e sensors, the following counters can be reset: High Temp and High Conductivity.

Press the button Reset Counters.

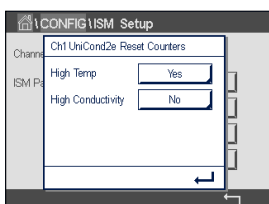

Select Yes for the desired counter to be reset and press enter. The reset will be done after saving the changes.

Press \leftarrow to exit the menu Reset Counters.

8.5.8 Set Calibration Interval for UniCond2e Sensors

For UniCond2e sensor the Cal Interval (calibration interval) can be set.

Press the button Cal Interval.

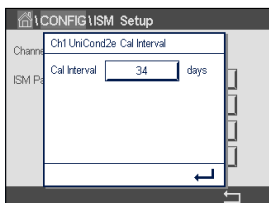

Press the input field next to **Cal Interval** and enter the value for the calibration interval. Based on this value the Time To Calibration (TTCal) will be calculated by the transmitter. Press \leftarrow to accept the value. The new value will be written to the sensor after saving the changes.

Press \leftarrow to exit the menu Cal Interval.

8.6 General Alarm

PATH: \leftarrow \ CONFIG \ General Alarm

See the following explanation to get more details about the different settings for General Alarm.



Press the button Event in the line of the settings for **Option** and select the events, that should be considered for an alarm.

To activate a relay if the defined conditions are reached press the input field in the line for the settings of **Relay**. Only relay 1 can be assigned to general alarm. For general alarms the operation mode of the assigned relay is always inverted.

Enter the **Delay** time in seconds. A time delay requires the setpoint to be exceeded continuously for the specified length of time before activating the relay. If the condition disappears before the delay period is over, the relay will not be activated.

8.7 ISM / Sensor Alarm

PATH: \leftarrow \ CONFIG \ ISM / Sensor Alarm

See the following explanation to get more details about the different settings for ISM / Sensor Alarm.

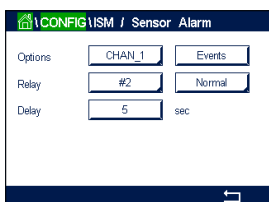

Select the channel by pressing the related button in the line of the settings for **Option**.

Depending on the selected channel or assigned sensor the **Events** that will be considered for generating an alarm can be selected. Some alarms will be considered in any case and not have to be selected or deactivated.

To select the desired relay that will be activated if an event has taken place press the input field in the line for the settings for **Relay**.

The operation mode of the relay can be defined.

Relay contacts are in normal mode until one of the selected events has taken place. Then the relay is activated and the contact states change. Select Inverted to reverse the normal operating state of the relay (i.e. normally open contacts are in an open state, and normally closed contacts are in a closed state if an event has taken place).

Enter the **Delay** time in seconds. A time delay requires the event to be occurred continuously for the specified length of time before activating the relay. If the condition disappears before the delay period is over, the relay will not be activated.

8.8 Clean

PATH:  \ CONFIG \ Clean

See the following explanation to get more details about the different settings for Clean

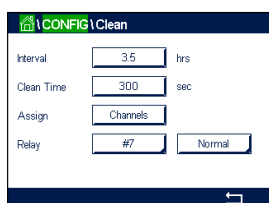

Enter the cleaning **Interval** time in hours. The cleaning interval can be set from 0.000 to 99999 hours. Setting it to 0 turns the clean cycle off.

Enter the **Clean Time** in seconds. The clean time can be 0 to 9999 seconds and must be smaller than the cleaning interval.

Assign the channel(s) for cleaning cycles. The assigned channels will be in HOLD state during the cleaning cycle.

Choose a **Relay**. Relay contacts are in normal mode until the cleaning cycle starts, then the relay is activated and the contact states change. Select Inverted to reverse the normal operating state of the relay (i.e. normally open contacts are in an open state, and normally closed contacts are in a closed state when the cleaning cycle starts).

8.9 Display Setup

PATH:  \ CONFIG \ Display Setup

See the following explanation to get more details about the different settings for Display Setup

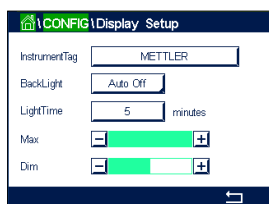

Enter the name for the M800 Transmitter (**Instrument Tag**). The instrument tag will also be displayed on the line at the top of the Start Screen and Menu Screen.

Use **BackLight** to switch off or dim the transmitter screen after a defined time period without interaction. The transmitter screen will automatically come back after pressing the display.

Enter the **Light Time** in minutes. The light time is the time period without interaction before the transmitter screen will be dimmed or switched off.

NOTE: In case of an unacknowledged warning or alarm the transmitter screen will not be dimmed or switched off even if the light time has been elapsed

The parameter **Max** allows the setting of the backlight during operation. With the parameter **Dim** the backlight of the transmitter screen during the dimmed state can be adjusted. Press the + or - buttons in the corresponding line to adjust the parameters.



8.10 Digital Inputs

PATH:  \ CONFIG \ Digital Inputs

See the following explanation to get more details about the different settings for the digital inputs

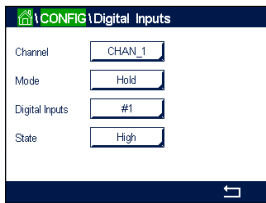

Press the related button for the assignment of the **Channel** (Chan_). Select the channel, which has to be linked to the digital input signal.

Press the input field in the line of the setting for **Mode** and select the impact of an active digital input signal. Choose 'HOLD' to lead the assigned channel in HOLD state. For flow sensor the digital input signal can be used to reset the totalized flow value (Reset T-flow) for the channel. If an optical DO sensor is connected, the digital input signal can be used for LED controlling.

Press the related button for the assignment of the **Digital Inputs** (#1 for DI1, #2 for DI2 etc.) and select the digital input signal, which has to be linked to the channel.

An additional setting can be done, if a digital input signal has been selected.

Press the input field in the line for the setting of the **State** and select if the digital input is active at high or low level of the voltage input signal.

8.11 System

PATH:  \ CONFIG \ System

See the following explanation to get more details about the different settings for the System.

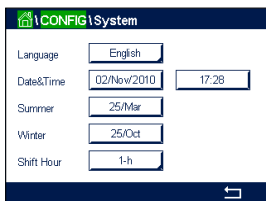

Select the desired **Language**. The following languages are available:

English, French, German, Italian, Spanish, Portuguese, Russian, Chinese, Korean or Japanese.

Enter **Date&Time**.

The automatic change-over from summertime to wintertime and vice-versa frees the users from having to correct the time twice a year.

The winter to summer time-change is carried out automatically using the 12-month clock integrated in the transmitter. The date for the time-change can be set with the parameter **Summer**.

Provided it is a Sunday, the time-change would take place on the day that equates with the value, otherwise on the following Sunday. The winter/summer time-change takes place at 02:00 h.

The summer to winter time-change is carried out automatically using the 12-month clock integrated in the transmitter. The date for the time-change can be set through the parameter **Winter**.

Provided it is a Sunday, the time-change would take place on the day that equates with the value, otherwise on the following Sunday. The winter/summer time-change takes place at 03:00 h.

The number of hours, the clock will be shifted through the winter to summer and summer to winter time-change can be chosen. Press the related button for the setting of the **Shift Hour**.

8.12 PID Controller

PATH:  \ CONFIG \ PID Controller

PID control is proportional, integral and derivative control action that can provide smooth regulation of a process. Before configuring the transmitter, the following process characteristics must be identified.

Identify the **control direction** of the process

– **Conductivity:**

Dilution – direct acting where increasing measurement produces increasing control output such as controlling the feed of low conductivity diluting water to rinse tanks, cooling towers or boilers

Concentrating – reverse acting where increasing measurement produces decreasing control output, such as controlling chemical feed to attain a desired concentration

– **Dissolved Oxygen:**

Deaeration – direct acting where increasing DO concentration produces increasing control output such as controlling the feed of a reducing agent to remove oxygen from boiler feedwater

Aeration – reverse acting where increasing DO concentration produces decreasing control output, such as controlling an aerator blower speed to maintain a desired DO concentration in fermentation or wastewater treatment

– **pH/ORP:**

Acid feed only – direct acting where increasing pH produces increasing control output, also for ORP reducing reagent feed

Base feed only – reverse acting where increasing pH produces decreasing control output, also for ORP oxidizing reagent feed

Both acid and base feed – direct and reverse acting

Identify the **control output type** based on the control device to be used:

Pulse frequency – used with pulse input metering pump

Pulse length – used with solenoid valve

Analog – used with current input device such as electric drive unit, analog input metering pump or current-to-pneumatic (I/P) converter for pneumatic control valve

Default control settings provide linear control, which is appropriate for conductivity, dissolved oxygen. Therefore, when configuring PID for these parameters (or simple pH control) ignore settings of deadband and corner points in the tuning parameter section below. The non-linear control settings are used for more difficult pH/ORP control situations.

If desired, identify the non-linearity of the pH/ORP process. Improved control can be obtained if the non-linearity is accommodated with an opposing non-linearity in the controller. A titration curve (graph of pH or ORP vs. reagent volume) made on a process sample provides the best information. There is often a very high process gain or sensitivity near the setpoint and decreasing gain further away from the setpoint. To counteract this, the instrument allows for adjustable non-linear control with settings of a deadband around the setpoint, corner points further out and proportional limits at the ends of control as shown in the figure below.

Determine the appropriate settings for each of these control parameters based on the shape of the pH process titration curve.

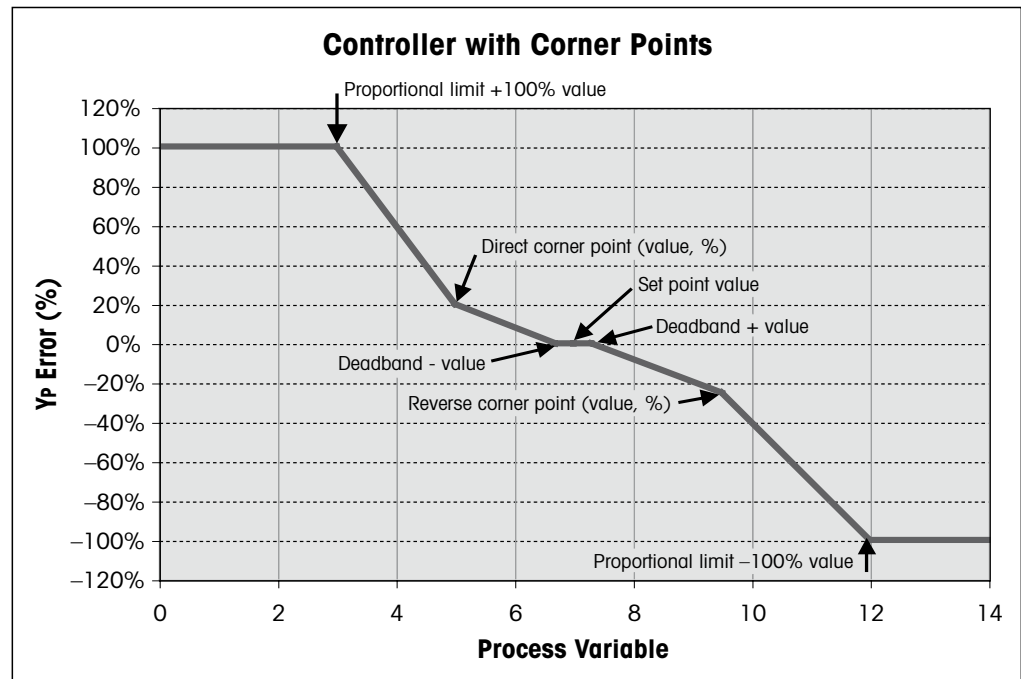

See the following explanation to get more details about the different settings for PID Controller.

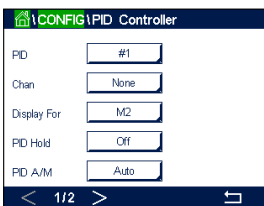

The M800 provides to 2 PID controllers. Press the input field in the line of the setting for **PID** and select the desired PID controller for configuration through pressing the button #1 for PID controller 1 and #2 for PID controller 2.

Press the related button for the assignment of the channel (**Chan**). Select the channel, which has to be linked to the PID Controller. To deactivate the PID controller press None.

Press the button for the assignment of the measuring parameter – based on the selected channel – that has be linked to the PID controller. Choose the measuring parameter by pressing the according field. Mx in the display indicates the measurement assigned to the PID Controller. (see chapter 8.1.1 “Channel Setup”).

The M800 offers the display of control output (%PID) of the PID controller in the Start Screen and Menu Screen. Press the related button for **Display For** and select the line, the control output should be displayed by pressing the corresponding field.



NOTE: The control output of the PID controller will be displayed instead of the measurement, that has been defined to be shown in the corresponding line (see chapter 8.1.1 “Channel Setup”).

Select with the parameter **PID HOLD** the state of the control output for the PID controller if the M800 Transmitter is in HOLD mode. Off means that the control output will be 0%PID if the transmitter is in HOLD mode. If Last Value has been chosen, the value for the control output signal before the transmitter went into HOLD mode will be used.

The parameter **PID A/M** allows selection of auto or manual operation for the PID controller. If auto has been chosen, the transmitter calculates the output signal based on the measured value and the settings of the parameters for the PID controller. In the case of manual operation, the transmitter shows in the Menu Screen at the line where the output signal is displayed two additional arrow buttons. Press the arrows buttons to increase or decrease the PID output signal.



NOTE: If Manual has been chosen the values for the time constants, gain, corner points, proportional limits, setpoint and deadband do not have any influence on the output signal.

Additional settings can be done by navigating to the next page of the menu.

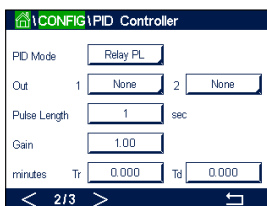

The **PID Mode** assigns a relay or analog output for PID control action. Based on the control device being used, select one of the three options Relay PL, Relay PF and Aout through pressing the corresponding field

- Relay PL: If using a solenoid valve, select Relays PL (Pulse Length).
- Relay PF: If using a pulse input metering pump, select Relays PF (Pulse Frequency)
- Aout: For using an analog control select Aout.

Link the output signal **Out1,2** of the PID controller to the desired output of the transmitter. Press the related button for Out 1 and Out 2 and select the corresponding number for the output through pressing the according field. #1 means relay 1 or Aout 1, #2 means relay 2 our Aout 2 etc.



NOTE: Take care if reed type relays are linked to the controlling function. The reed type relays could be used for pulse frequency control devices and light duty applications. The current is limited to 0.5 amps and 10 watts (see also chapter 15.2 "Electrical specifications"). Do not connect to this relays higher current devices.

If the PID Mode is set to Relay PL, the Puls Length for the output signal of the transmitter can be adjusted. Press the button for **Pulse Length** and the M800 displays a keypad for modifying the value. Enter the new value in the unit seconds according to the table below and press \leftarrow .



NOTE: A longer pulse length will reduce wear on the solenoid valve. The % "on" time in the cycle is proportional to the control output.

	1 st Relay Position (Out 1)	2 nd Relay Position (Out 2)	Pulse Length (PL)
Conductivity	Controlling concentrating reagent feed	Controlling dilution water	Short (PL) provides more uniform feed. Suggested start point = 30 sec
pH/ORP	Feeding base	Feeding acid	Reagent addition cycle: short PL provides more uniform addition of reagent. Suggested start point = 10 sec
Dissolved Oxygen	Reverse control action	Direct acting control action	Feed cycle time: short PL provides more uniform feed. Suggested start point = 30 sec

If the PID Mode is set to Relay PF, the Pulse Frequency for the output signal of the transmitter can be adjusted. Press the button for **Pulse Freq** and enter the new value in the unit pulse / minute according to the table below.



NOTE: Set the pulse frequency to the maximum frequency allowed for the particular pump being used, typically 60 to 100 pulses/minute. Control action will produce this frequency at 100% output.



CAUTION: Setting the pulse frequency too high may cause the pump to overheat.

	1 st Relay Position = #3	2 nd Relay Position = #4	Pulse Frequency (PF)
Conductivity	Controlling concentrating chemical feed	Controlling dilution water	Max allowed for the pump used (typically 60–100 pulses/minute)
pH/ORP	Feeding base	Feeding acid	Max allowed for the pump used (typically 60–100 pulses/minute)
Dissolved Oxygen	Reverse control action	Direct acting control action	Max allowed for the pump used (typically 60–100 pulses/minute)

If the PID Mode is set to **Aout**, the type for the analog output signal of the transmitter can be selected. Press the corresponding button and choose between 4 to 20 mA and 0 to 20 mA for the output signal by pressing the according field.

For the assignment of the analog output signal consider the table below.

	1 st Analogout Position = Out 1	2 nd Analogout Position = Out 2
Conductivity	Controlling concentrating chemical feed	Controlling dilution water
pH/ORP	Feeding base	Feeding acid
Dissolved Oxygen	Reverse control action	Direct acting control action

Press the input field for the parameter **Gain** to enter the gain of the PID controller as a unitless value. Gain represents the maximum value of the output signal of the PID controller in per cent (value 1 corresponds to 100%).

Press the corresponding input field in the line of **min** to adjust the Parameter integral or reset time **Tr** (left button) and/or rate of derivate time **Td** (right button).



NOTE: Gain, integral and derivate time are usually adjusted later by trial and error on process response. It is recommended to start with the value $Td = 0$.

Further settings can be done by navigating to the next page of the menu.

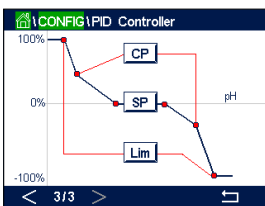

The display shows PID controller curve with input buttons for the corner points, setpoint and proportional limit for 100%.

Press the button **CP** to enter the menu for adjusting the corner points.

Page 1 shows the Corner Limit Low settings. Press the corresponding button to modify the value for the process parameter and the related output signal in %.

Browse to page 2 and the Corner Limit High settings are displayed. Press the corresponding button to modify the value for the process parameter and the related output signal in %.

Press the button **SP** to enter the menu for adjusting the setpoint and the dead band.

Press the button **Lim** to enter the menu for adjusting the proportional limit high and the proportional limit low, the range over which control action is required.

8.13 Service

PATH:  \ CONFIG \ Service

This menu is a valuable tool for troubleshooting and provides diagnostic functionality for the following items: Calibrate TouchPad, Set Analog Outputs, Read Analog Outputs, Read Analog Inputs, Set Relays, Read Relays, Read Digital Inputs, Memory, Display and optical DO sensors.

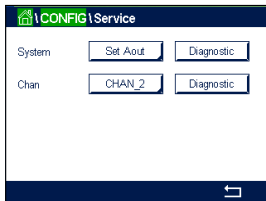

Select through the parameter **System** the desired item for diagnostic by pressing the according field.

Select through **Chan** the channel for diagnostic information of the sensor. This menu is only displayed if a sensor is connected.

The provided diagnostic functionality can now be called up through pressing the button **Diagnostic**.

8.13.1 Set Analog Outputs

The menu enables the user to set all analog outputs to any mA value within the 0–22 mA range. Use the + and – button to adjust the mA output signal. The transmitter will adjust the output signals according to the measurement and configuration of the analog output signals.

8.13.2 Read Analog Outputs

The menu shows the mA value of the analog outputs.

8.13.3 Read Analog Inputs

The menu shows the mA value of the analog input signals.

8.13.4 Set Relay

The menu allows the user to open or close each relay manually. If the menu is exited, the transmitter will switch the relay according to configuration.

8.13.5 Read Relay

The menu shows the state of every relay. On indicates the relay is closed, Off indicates that the relay is open.

8.13.6 Read Digital Inputs

The menu shows the state of the digital input signals.

8.13.7 Memory

If Memory is selected the transmitter will perform a memory test of all connected transmitter boards and ISM sensors.

8.13.8 Display

The transmitter shows every 5 seconds red, green, blue, grey and dark grey display and returns afterwards to the menu Service. If within the 5 seconds for every color the screen is pressed the transmitter will go to the next step.

8.13.9 Calibrate TouchPad

During the 4 calibrations steps, always press the center of the circle shown circle in the 4 corners of the display. The transmitter will show the calibration result.

8.13.10 Channel Diagnostic

If an error has occurred with the sensor, the corresponding messages are displayed.

8.14 Technical Service

PATH:  \ CONFIG \ Technical Service

This menu is only intended for METTLER TOLEDO's service and is password-protected.

With this menu the calibration factors for the analog input and output signals can be shown.

Select through the parameter **Options** the signal(s), the calibration factors should be displayed for.

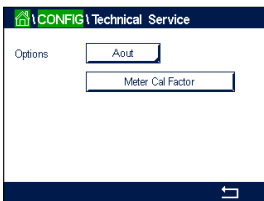

8.15 User Management

PATH:  \ CONFIG \ User Management

This menu allows for the configuration of different user and administrator passwords, as well as setting up a list of allowed menus for the different users. The administrator has rights to access all menus. All default passwords for new transmitters are "00000000".

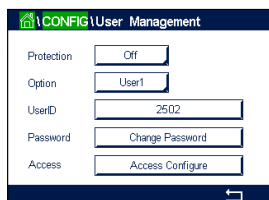

Press the input field in the line of **Protection** and select the desired kind of protection. The following options are available:

Off: No protection

Active: Activation of the Menu Screen (see chapter 3.2.2 "Activation Menu Screen") has to be confirmed

Password: Activation of the Menu Screen is only possible with a password

Press the according button for **Option** to select the profile for the administrator (Admin) or one of the users.

NOTE: The administrator always has the rights to access all menus. For different users the access rights can be defined.

Press the input button for **UserID** to enter the name for the user or administrator. The name for the user or administrator will be displayed if the protection via password is selected for activation of the Menu Screen.

For changing the password of the selected user or administrator press the input field for **Password**. Enter the old password in the field Old PW, the new one in the field New PW and confirm it in the field confirm PW. The default password is "00000000" for the administrator and all users.

If the profile for a user has been selected an additional input field to define the access rights will be displayed.

To assign access rights the according button for the menu has to be pressed. In case of an assignment of the access rights, is displayed in the related button.

8.16 Reset

PATH:  \ CONFIG \ Reset

Depending on the transmitter version and configuration different options for a reset are available.

See the following explanation to get more details about the different option to reset data and / or configurations.

8.16.1 System Reset

This menu option allows the reset of the M800 Transmitter to the factory default settings (set-points off, analog outputs off, passwords, etc.). Furthermore the calibration factors for analog in- and outputs, meter etc. can be set to the last factory values.

Press the input field for **Options** and select System.

Press the input field for **Items** (Configure button) and select the different parts of the configuration that will be reset.

If an item has been selected the Action menu is displayed. Press the Reset button.

8.16.2 Reset Sensor Calibration for Optical DO Sensors

If an optical oxygen sensor is connected to the transmitter, a menu is available that allows the reset of the calibration data of the sensor to the factory settings.

Press the input field for **Options** and select the channel the optical DO sensor is connected to.

Press the input field for **Items** (Configure button). Select SensorCal to Factory by pressing the according button.

If SensorCal to Factory has been selected the Action menu is displayed. Press the Reset button.



NOTE: Through a reset of the calibration data the Adaptive Calibration Timer (see chapter 9.1 "iMonitor") will set to 0.



NOTE: To ensure best measuring results, a new calibration of the sensor is recommended after a reset of the calibration data to factory settings. Depending on the application and sensor, the calibration should be performed as a one-point calibration or two-point calibration (see chapter 7.7 "Calibration of Optical Oxygen Sensors (ISM Sensors only)").

8.16.3 Reset Sensor Calibration for UniCond2e Sensors

For UniCond2e sensors, the SensorCal (sensor calibration) and ElecCal (sensor electronics calibration) can be restored to factory settings.

Press the input field for **Options** and select the channel the UniCond2e sensor is connected to.

Press the input field for **Item** (Configure button). Select SensorCal to Factory and/or ElecCal to Factory by checking the adjacent box. Press \leftarrow enter to accept the value.

If an item has been selected the Action menu is displayed. Press the Reset button.

The M800 will bring up the confirmation dialog. Select Yes and the reset will be executed. Press No to go back to menu Reset without performing the reset.

8.16.4 Reset Total Flow

For models of the M800 Transmitter that accept flow signals the totalized flow value for each channel can be reset.

Press the input field for **Options** and select the channel for which the totalized flow value should be reset.

Press the input field for **Items** (Configure button). Select Total Flow by checking the adjacent box. Press \leftarrow to accept the value.

If Total Flow has been selected the Action menu is displayed. Press the Reset button.

The M800 will bring up the confirmation dialog. Select Yes and the reset will be executed. Press No to go back to menu Reset without performing the reset.

8.16.5 Reset for CO₂ hi Measurement

If a thermal conductivity dissolved CO₂ sensor is connected to the transmitter, a menu is available that allows the reset of the measurement circuit from the sensor.

Under the circumstances the sensor detects an error, the sensor will run into the sensor protection mode. The electronic measurement circuit will be shut down for sensor protection and needs to be restarted after the fixing of the failure for accurate CO₂ measurement.

Press the input field for **Options** and select the channel with the CO₂ sensor, which should be reset.

Press the input field for **Items** (Configure button). Select CO₂ Measurement by checking the adjacent box. Press **↵** to accept the value.

If CO₂ Measurement has been selected the Action menu is displayed. Press the Reset button.

The M800 will bring up the confirmation dialog. Select Yes and the reset will be executed. Press No to go back to menu Reset without performing the reset.

8.16.6 Reset for Turbidity Sensor

If a turbidity sensor is connected to the transmitter, a menu is available that allows the reset of the calibration data of the sensor to the factory settings.

Press the input field for **Options**. Select Turb. for analog turbidity sensors (InPro8000 series). Select ISM for digital turbidity sensors (InPro8600i)

Press the input field for **Items** (Configure button). Activate the check box for the item to be reset. Press **↵** to accept the value.

If an item has been selected the Action menu is displayed. Press the Reset button.

8.17 RS485 Output

PATH:  \ CONFIG \ RS485 Output

This menu option allows measurement values of different channels to be printed or output for data log by external RS485. And the configuration data like printer line, printer interval time and each line's measurement can be set by user.

Select the Output Mode, Off, Printer, Data Log or Query.

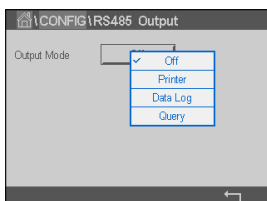

8.17.1 Printer Output Configuration

The Printer menu option allows configuring the M800 RS485 output to send data to a suitable printer. The printer output may be configured to print up to 6 configure measurements on separate lines, for each available sensor input, including pulsed input channels. At each print cycle, the output will include a header line with data and time based on the M800 internal clock, and one line for each configured measurement including channel, measurement descriptor, measurement value and unit of measure.

The output will appear as follows:

11/May/2012 15:36

Ch Label Measurement

1 CHAN_1 302 ppbC

2 CHAN_2 0.54 uS/cm

3 CHAN_3 7.15 pH

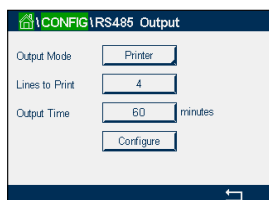

To configure the printer output, select option Printer for Output Mode. Configure the following options:

Lines to Print will configure the number of measurements that will be printed for each print cycle. Enter the total number of measurements to be configured for output.

Output Time defines the time in minutes between each print cycle. Output time may be set from 1 to 1000 minutes.

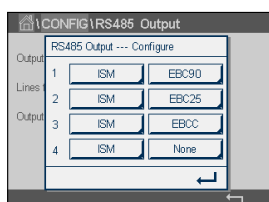

Once the output time and print lines have been established, press the Configure button to format the printer output. The number at the left of the window shows the order in which the lines will appear on the printer output. From the first dropdown, select the channel which the desired sensor is connected. This dropdown will list the labels associated with each channel as configured under Channel Setup. Using the second dropdown, select the unit associated with the measurement to be displayed. Note that if more than 4 lines of output has been selected, use the < and > icons to navigate through the pages to be configured.

8.17.2 Data Log Configuration

Select option Data Log for Output Mode. Configure the following options:

Measures to Send will configure the number of measurements that will be printed in one line. Enter the total number of measurements to be configured for output.

Output Time defines the interval time in seconds for minutes or outputting a whole line. Maximum time limit is one hour (3600 sec).

If for **Send Header** Yes is chosen, a header will be sent to RS485 port once immediately. Default setting is No.

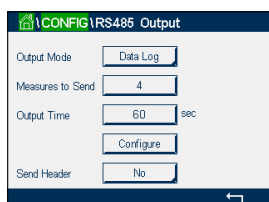

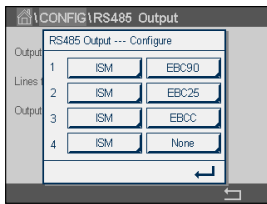

Once the output time and measures to send have been established, press the Configure button to format the output. The number at the left of the window shows the order in which the lines will appear on the output. From the first dropdown, select the channel which the desired sensor is connected. This dropdown will list the labels associated with each channel as configured under Channel Setup. Using the second dropdown, select the unit associated with the measurement to be displayed. Note that if more than 4 lines of output has been selected, use the < and > icons to navigate through the pages to be configured.

8.18 USB Measurement Interface

The user may access measurement values via the USB. The user provides a command and the M800 responds using the following format.

Command: [0x02][0x02]"Dx"(x is the channel index: 1-6)

Response: "XXXXXXXXuuuuuu XXXXXXXXuuuuuu XXXXXXXXuuuuuu XXXXXXXXuuuuuu"<cr>



NOTE: The first instance of 0x02 is the ID for M800, which must be 0x02 only. The second instance of 0x02 is the length, which must be 0x02 only. The response provides M1~M4 only. XXXXXXXX is measurement floating value in ASCII.

uuuuuu is the unit in ASCII, if current unit is less than 6 characters, the format is right aligned, e.g. if unit is pH, response " pH".

<cr> means carriage return (0x0D, 0x0A)

If the sending command is not correct an error message is generated.

Error response format: "ERROR #xx"

xx is the error code

01: Invalid opcode ---- if it is not D.

02: Parameter error ---- if x is not 1-6

07: Length error ---- if length is not 2.

9 ISM

For the menu structure refer to chapter 3.4.1 "Menu Structure".

PATH:  \ ISM

9.1 iMonitor

PATH:  \ ISM \ iMonitor

The iMonitor gives an overview of the current state of the complete loop at a glance.

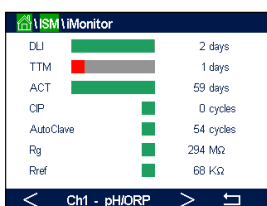

The iMonitor of the first channel is displayed on the screen. To browse through the iMonitor for the different channels press > at the bottom of the display.

The values DLI, TTM and ACT as well as TTCal in combination with UniCond2e sensors are shown as bar graph. If the values falls below 20% of the initial value the bar graph changes from green to yellow color. If the value falls below 10% the color changes to red.

For Cond4e sensors the days in operation of the sensor are displayed.

Furthermore SIP-, CIP-, AutoClave-, SAN-cycles as well as the values for Rg and Rref can be displayed and assigned to a colored button if the values are provided by the sensor.

The color for the related button of SIP-, CIP-, Autoclave- and SAN-cycles will change from green to yellow if less then 20% of the defined maximum quantity for the cycle remain and to red if less then 10% remain. For configuration of the maximum quantity see chapter 8.5 "ISM Setup (ISM Sensors only)".

The buttons for Rg and Rref change to yellow if the conditions for a warning messages are fulfilled and to red if the conditions for a alarm message are fulfilled. The buttons remain grey if the corresponding ISM alarm is not configured (see chapter 8.7 "ISM / Sensor Alarm").

Depending on the measured parameter (connected sensor) the following data are available in the menu iMonitor:

pH:	DLI, TTM, ACT, CIP, AutoClave, SIP*, Rg**, Rref**
Amperometric O ₂ :	DLI, TTM, ACT, CIP, AutoClave, SIP*, Electrolyte***
Optical O ₂ :	DLI, ACT, CIP, AutoClave, SIP*
O ₃ :	DLI, TTM, ACT, SAN
Cond:	Days in operation, TTCal****, CIP, SIP
Turbidity:	Sensor status as humidity, temperature, operating hours, stray light and max. temperature

- * if AutoClave has not been activated (see chapter 8.7 "ISM / Sensor Alarm")
- ** if the alarm for Rg and/or Rref has been activated (see chapter 8.7 "ISM / Sensor Alarm")
- *** if the alarm for Electrolyte Level Error has been activated (see chapter 8.7 "ISM / Sensor Alarm")
- **** if UniCond2e sensor is connected

9.2 Messages

PATH:  \ ISM \ Messages

The messages for occurred warnings and alarms are listed in this menu. Up to 100 entries will be listed.

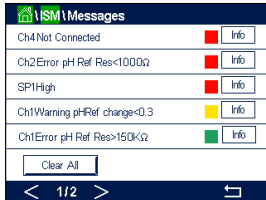

5 messages per page are listed. If more than 5 messages are available additional pages can be accessed.

Unacknowledged alarms or warnings will be listed at the beginning. Then the acknowledged but still existing alarm or warning are listed. At the end of the list the already solved warning and alarms are described. Between these groups the messages are listed chronologically.

The state of the warning or alarm is indicated through the following signs:

Red button blinking	Alarm exists and has not been acknowledged
Red button not blinking	Alarm exists and has been acknowledged
Yellow button blinking	Warning exists and has not been acknowledged
Yellow button not blinking	Warning exists and has been acknowledged
Grey button not blinking	Warning or alarm has been solved

An unacknowledged warning or alarm will be acknowledged by pressing the **Info** button in the corresponding line.

For every message the corresponding **Info** button can be pressed. Message information, date and time the warning or alarm has been occurred and the status of the alarm or message are displayed.

If warning or alarm has already been solved the pull up window for the message shows an additional button to clear the message i.e. to delete it from the message list.

9.3 ISM Diagnostics

PATH:  \ ISM \ ISM Diagnostics

The M800 Transmitter provides for all ISM sensors a diagnostic menu. Access the menu Channel and select the channel by pressing the related input field.

Depending on the selected channel and assigned sensor different diagnostic menus are displayed. See the following explanation to get more details about the different diagnostic menus.

9.3.1 pH/ORP, Oxygen, O₃ and Cond4e Sensors

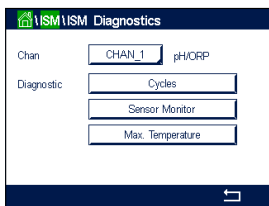

If an pH/ORP, oxygen, O₃ or Cond4e sensor is connected to the selected channel, the diagnostic menu cycles, sensor monitor and max. temperature are available.

Press the **Cycle** button and the information for CIP, SIP and Autoclave cycles of the connected sensor are displayed. The displayed information shows the amount of cycles the sensor has been exposed and the max. limitation for the corresponding cycle as defined in the menu ISM Setup (see chapter 8.5 "ISM Setup (ISM Sensors only)").



NOTE: For Cond4e and optical DO sensors, which are not autoclavable the menu AutoClave Cycles is not displayed.



NOTE: For O₃ sensors the SAN cycles are displayed.

Press the **Sensor Monitor** button and the information for DLI, TTM and ACT of the connected sensor are displayed. The values DLI, TTM and ACT are shown as bar graph. If the values falls below 20% of the initial value the bar graph changes from green to yellow color. If the value falls below 10% the color changes to red.



NOTE: For Optical DO sensors TTM does not exist.



NOTE: For Cond4e sensors the operating hours are displayed.

Press the **Max. Temperature** button and the information about the maximum temperature, that the connected sensor has ever seen, together with a time stamp of this maximum is displayed. This value is stored on the sensor and cannot be changed. During autoclaving the max. temperature is not recorded.



NOTE: For Optical DO sensors the max. temperature of the board and of the spot are displayed.

9.3.2 UniCond2e and UniCond4e Sensors

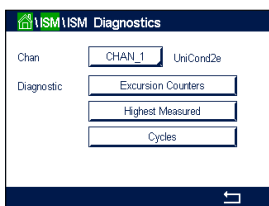

For UniCond2e and UniCond4e sensors, the following diagnostic items can be viewed: Excursion Counters including High Temp and High Conductivity, Highest Measured including Highest Temp and Highest Cond, Cycles including CIP cycles and SIP Cycles.

9.4 Calibration Data

PATH:  \ ISM \ Calibration Data

The M800 Transmitter provides a calibration history for all ISM sensors. Depending on the selected channel and assigned sensor different data is available for the calibration history.

See the following explanation to get more details about the different data available for the calibration history.

9.4.1 Calibration Data for All ISM Sensors excluding UniCond2e and UniCond4e

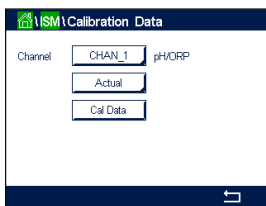

If an ISM sensor – excluding UniCond2e and UniCond2e – is connected to the selected channel between the calibration data set of

Actual (Actual adjustment): This is the actual calibration dataset which is used for the measurement. This dataset moves to Cal1 position after the next adjustment.

Factory (Factory calibration): This is the original dataset, determined in the factory. This dataset remains stored in the sensor for reference and cannot be overwritten.

1.Adjust (First adjustment): This is the first adjustment after the factory calibration. This dataset remains stored in the sensor for reference and cannot be overwritten

Cal1 (last calibration/adjustment): This is the last executed calibration/adjustment data set. This dataset moves to Cal2 and then to Cal3 when a new calibration/adjustment is performed. Afterwards, the dataset is not available anymore. Cal2 and Cal3 acting in the same way as Cal1.

Cal2 and **Cal3** can be chosen. For the selection of the calibration data set press the corresponding field.



NOTE: The amperometric oxygen sensor of THORNTON and the O₃ sensor do not provide the data set Cal1, Cal2, Cal3 and 1.Adjust.

Press the **Cal Data** button and the corresponding calibration data set is displayed. Furthermore the time stamp for the calibration and the User ID is listed.



NOTE: This function requires the correct setting of date and time during calibration and / or adjustment tasks (see chapter 8.11 "System").



NOTE: Turbidity ISM sensors offer slope or offset process calibration only. The process calibration data is stored in Actual. Reset to factory data is performed in the Reset menu.

9.4.2 Calibration Data for UniCond2e and UniCond4e Sensors

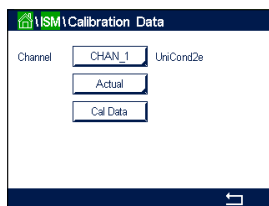

For UniCond2e and UniCond4e sensors the following three sets of calibration data may be selected:

Actual (Actual calibration): This is the actual calibration dataset which is used for the measurement.

Factory (Factory calibration): This is the original dataset, determined in the factory. This dataset remains stored in the sensor for reference and cannot be overwritten.

Cal1 (last calibration/adjustment): This is the last executed calibration/adjustment data set.

Press the Cal Data button and the corresponding calibration data set is displayed.

If the data set of the actual calibration has been chosen, on page 1, the date and time of the calibration, User ID, conductivity calibration constants, and reference conductivity values to calibrate are displayed. On page 2 the As-found conductivity values and the deviation from the reference are shown. On page 3 and 4 the same information for temperature is displayed. On page 5 the calibration cycles applied to the sensor and the next calibration date for conductivity (C) and temperature (T) are displayed.

If the dataset of the factory calibration has been chosen, on page 1, the date and time of the calibration, the conductivity calibration constants, and reference conductivity values used to calibrate are displayed. On page 2, the same values for temperature are shown.

Press ← to exit the menu Cal Data.



NOTE: This function requires the correct setting of date and time during calibration and / or adjustment tasks (see chapter 8.11 "System").

9.5 Sensor Info

PATH: \ ISM \ Sensor Info

The model, hardware and software version, last calibration date as well as the product and serial number of the ISM sensors, that are connected to the M800 Transmitter can be displayed on the screen.

Enter Sensor Info.

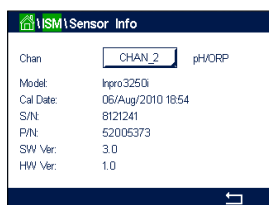

The data of the first channel, a sensor is connected, are displayed on the screen. Press the input field in the line of Chan. To get the data of the desired sensor select the corresponding channel by pressing the according field.

The data Model, Cal Date (date of last adjustment), S/N (serial number), P/N (product number), SW Ver (software version) and HW Ver (hardware version) of the select sensor are displayed.



NOTE: If a UniCond2e sensor is connected the following data is also displayed, Temp Sens. (temperature sensor) Electrode (electrode material), Body/Ins Mat: (body and/or insulator material), Inner: (inner electrode material), Outer (outer electrode material) Fitting: (fitting material), Class VI (FDA Class VI material).

To exit the menu Sensor Info press \leftarrow . To return to the Menu Screen press \rightarrow .

9.6 HW / SW Version

PATH: \rightarrow \ ISM \ HW/SW Version

The hardware and software version as well as the product number and serial number of the M800 Transmitter itself or the different boards, that are plugged in can be displayed on the screen.



The data of the transmitter is displayed on the screen. Press the input field in the line of **M800**. To select the data of the desired board or the transmitter itself press the corresponding field.

The data S/N (serial number), P/N (product number), SW Ver (software version) and HW Ver (hardware version) of the select board or transmitter are displayed.

9.7 Log Book

PATH: \rightarrow \ ISM \ Sensor Info

The M800 Transmitter provides a log book with 250 entries. The log book is managed as an ring buffer, i.e. entry 251 causes the erasing of entry no. 1 etc.

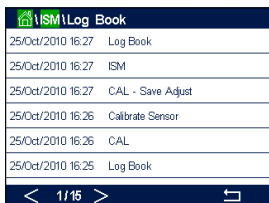

The entries show time stamp and action.

10 Wizards

PATH:  \ WIZARD

The M800 Transmitter allows set up of up to 4 wizards / favorites to ensure a quick access for frequently used functions.

10.1 Set Wizard

PATH:  \ WIZARD \ Set Wizard



The main menus are displayed. Choose the menu, that contains the function, which should be defined as a wizard (favorite), e.g. ISM through pressing the corresponding arrow ► in the same line.

Choose the function, that should be set as a wizard by pressing the according button. A function, which is set as a wizard shows ★ icon.



NOTE: To delete the link to wizards, press the according button for the function. The wizard ★ icon is not shown any more.

10.2 Access to Wizards

Access the menu Set Wizards. The wizards defined are listed on this page. Press the corresponding arrow ► for the function in the same line.

11 Maintenance

11.1 Front panel cleaning

Clean the front panel with a damp soft cloth (water only, no solvents). Gently wipe the surface and dry with a soft cloth.

12 Software History

12.1 M800 Process

Software version	Release date	Software changes	Documentation / Issue
V2.2.01	January 2015	Minor software changes	52 121 825 M800 Transmitter 09/2015

12.2 M800 Water

Software version	Release date	Software changes	Documentation / Issue
V1.5.01	January 2015	Minor software changes	52 121 825 M800 Transmitter 09/2015

13 Troubleshooting

If the equipment is used in a manner not specified by Mettler-Toledo, the protection provided by the equipment may be void.

Review the table below for possible causes of common problems:

Problem	Possible Cause
Display is blank.	<ul style="list-style-type: none"> – No power to M800. – Hardware failure.
Incorrect measurement readings.	<ul style="list-style-type: none"> – Sensor improperly installed. – Incorrect units multiplier entered. – Temperature compensation incorrectly set or disabled. – Sensor or transmitter needs calibration. – Sensor or patch cord defective or exceeds recommended maximum length. – Hardware failure.
Measurement readings not stable.	<ul style="list-style-type: none"> – Sensors or cables installed too close to equipment that generates high level of electrical noise. – Recommended cable length exceeded. – Averaging set too low. – Sensor or patch cord defective.
Displayed red or yellow bar graph is flashing.	<ul style="list-style-type: none"> – Setpoint is in alarm condition (setpoint exceeded). – Alarm has been selected (see chapter 8.7 "ISM / Sensor Alarm") and occurred.
Cannot change menu settings.	<ul style="list-style-type: none"> – User locked out for security reasons.

13.1 Cond (resistive) Error messages/ Warning- and Alarm list for analog sensors

Alarms	Description
Watchdog time-out*	SW/System fault
Cond Cell open*	Cell running dry (no measurement solution) or wires are broken
Cond Cell shorted*	Short circuit caused by sensor or cable

* Activate this function in the transmitter settings (see chapter 8.6 "General Alarm"
PATH: Menu / General Alarm).

13.2 Cond (resistive) Error messages/ Warning- and Alarm list for ISM sensors

Alarms	Description
Watchdog time-out*	SW/System fault
Dry Cond sensor*	Cell running dry (no measurement solution)
Cell deviation*	Multiplier out of tolerance** (depends on sensor model).

* Activate this function in the transmitter settings (see chapter 8.6 "General Alarm"
PATH: Menu / General Alarm).

** For further information refer to the sensor documentation

13.3 pH Error messages/Warning- and Alarm list

13.3.1 pH sensors except dual membrane pH electrodes

Warnings	Description
Warning pH Slope >102%	Slope too big
Warning pH Slope <90%	Slope too small
Warning pH Zero \pm 0.5	Out of range
Warning pHGs change <0.3**	Glass electrode resistance changed by more than factor 0.3
Warning pHGs change >3**	Glass electrode resistance changed by more than factor 3
Warning pHRef change <0.3**	Reference electrode resistance changed by more than factor 0.3
Warning pHRef change >3**	Reference electrode resistance changed by more than factor 3

Alarms	Description
Watchdog time-out*	SW/System fault
Error pH Slope >103%	Slope too big
Error pH Slope <80%	Slope too small
Error pH Zero \pm 1	Out of range
Error pH Ref Res >150 K Ω **	Reference electrode resistance too big (break)
Error pH Ref Res <2000 Ω **	Reference electrode resistance too small (short)
Error pH Gls Res >2000 M Ω **	Glass electrode resistance too big (break)
Error pH Gls Res <5 M Ω **	Glass electrode resistance too small (short)

* ISM sensors only

** Activate this function in the transmitter settings (see chapter 8.6 "General Alarm"
PATH: Menu / General Alarm).

13.3.2 Dual membrane pH electrodes (pH/pNa)

Warnings	Description
Warning pH slope >102%	Slope too big
Warning pH Slope < 90%	Slope too small
Warning pH Zero \pm 1	Out of range
Warning pHGs change < 0.3*	Glass electrode resistance changed by more than factor 0.3
Warning pHGs change > 3*	Glass electrode resistance changed by more than factor 3
Warning pNaGs change < 0.3*	Glass electrode resistance changed by more than factor 0.3
Warning pNaGs change > 3*	Reference electrode resistance changed by more than factor 3

Alarms	Description
Watchdog time-out	SW/System fault
Error pH Slope >103%	Slope too big
Error pH Slope < 80%	Slope too small
Error pH Zero \pm 2	Out of range
Error pNa Gls Res > 2000 M Ω *	Glass electrode resistance too big (break)
Error pNa Gls Res < 5 M Ω *	Glass electrode resistance too small (short)
Error pH Gls Res > 2000 M Ω *	Glass electrode resistance too big (break)
Error pH Gls Res < 5 M Ω *	Glass electrode resistance too small (short)

* Activate this function in the transmitter settings (see chapter 8.6 "General Alarm"
PATH: Menu / General Alarm).

13.3.3 ORP messages

Warnings*	Description
Warning ORP ZeroPt > 30 mV	Zero offset too big
Warning ORP ZeroPt < -30 mV	Zero offset too small

Alarms*	Description
Watchdog time-out	SW/System fault
Error ORP ZeroPt > 60 mV	Zero offset too big
Error ORP ZeroPt < -60 mV	Zero offset too small

* ISM sensors only

13.4 Amperometric O₂ Error messages/ Warning- and Alarm list

13.4.1 High level oxygen sensors

Warnings	Description
Warning O ₂ Slope < -90 nA	Slope too big
Warning O ₂ Slope > -35 nA	Slope too small
Warning O ₂ ZeroPt > 0.3 nA	Zero offset too big
Warning O ₂ ZeroPt < -0.3 nA	Zero offset too small

Alarms	Description
Watchdog time-out*	SW/System fault
Error O ₂ Slope < -110 nA	Slope too big
Error O ₂ Slope > -30 nA	Slope too small
Error O ₂ ZeroPt > 0.6 nA	Zero offset too big
Error O ₂ ZeroPt < -0.6 nA	Zero offset too small
Electrolyte Low*	Too low level of electrolyte

* ISM sensors only

13.4.2 Low level oxygen sensors

Warnings	Description
Warning O ₂ Slope < -460 nA	Slope too big
Warning O ₂ Slope > -250 nA	Slope too small
Warning O ₂ ZeroPt > 0.5 nA	Zero offset too big
Warning O ₂ ZeroPt < -0.5 nA	Zero offset too small

Alarms	Description
Watchdog time-out*	SW/System fault
Error Install O ₂ Jumper	In case of using InPro 6900 a jumper has to be installed (see chapter: Connection of Sensor – Dissolved Oxygen)
Error O ₂ Slope < -525 nA	Slope too big
Error O ₂ Slope > -220 nA	Slope too small
Error O ₂ ZeroPt > 1.0 nA	Zero offset too big
Error O ₂ ZeroPt < -1.0 nA	Zero offset too small
Electrolyte Low*	Too low level of electrolyte

* ISM sensors only

13.4.3 Trace oxygen sensors

Warnings	Description
Warning O ₂ Slope < -5000 nA	Slope too big
Warning O ₂ Slope > -3000 nA	Slope too small
Warning O ₂ ZeroPt > 0.5 nA	Zero offset too big
Warning O ₂ ZeroPt < -0.5 nA	Zero offset too small

Alarms	Description
Watchdog time-out	SW/System fault
Error O ₂ Slope < -6000 nA	Slope too big
Error O ₂ Slope > -2000 nA	Slope too small
Error O ₂ ZeroPt > 1.0 nA	Zero offset too big
Error O ₂ ZeroPt < -1.0 nA	Zero offset too small
Electrolyte Low*	Too low level of electrolyte

* ISM sensors only

13.5 Warning- and Alarm Indication

13.5.1 Warning Indication

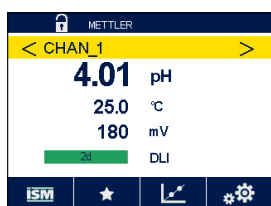

It will be indicated through a yellow bar graph on the display if there are conditions, that have generate a warning. If the corresponding channel is shown on the current Menu Screen or Start Screen (see chapter 3.2 "Display") the yellow bar graph is displayed in the line with the name of the channel. A warning message will be recorded and can be selected through the menu Messages (PATH: \ISM\Messages; see also chapter 9.2 "Messages").

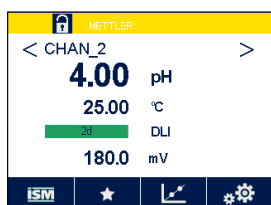

If a channel, that is not shown on the current Menu Screen or Start Screen has generated by a warning, a yellow bar graph is displayed on the head line of the display. A warning message will be recorded and can be selected through the menu Messages (PATH: \ISM\Messages; see also chapter 9.2 "Messages").



NOTE: If the warning has not been acknowledged the bar graph will blink. If the warning has already been acknowledged, the bar graph will be displayed continuously. See also chapter 9.2 "Messages". In the case of an unacknowledged warning or alarm the transmitter screen will not be dimmed or switched off even if the light time has been elapsed (see chapter 8.9 "Display Setup").



NOTE: If at the same time a channel has born an alarm and a warning indicated, the indication of the alarm will have higher priority. The alarm will be indicated (see chapter 13.5 "Warning- and Alarm Indication") on the Menu Screen or Start Screen, while the warning will not be shown.

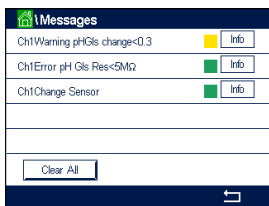

Pressing the yellow bar graph on the Menu Screen will lead to the Messages. Refer to chapter 9.2 "Messages" for the description of the functionality for this menu.

NOTE: The detection of some warnings can be activated/deactivated through (de)activating the corresponding alarm. Refer to chapter 8.7 "ISM / Sensor Alarm".

13.5.2 Alarm Indication

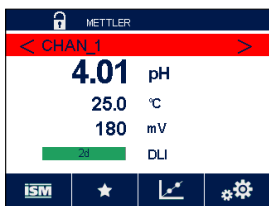

It will be indicated through a red bar graph on the display if there are conditions, that have generated an alarm. If the corresponding channel is shown on the current Menu Screen or Start Screen (see chapter 3.2 "Display") the red bar graph is displayed in the line with the name of the channel. An alarm message will be recorded and can be selected through the menu Messages (PATH: $\text{ISM}\backslash\text{Messages}$; see also chapter 9.2 "Messages").

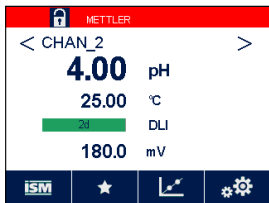

If a channel, that is not shown on the current Menu Screen or Start Screen has generated by an alarm, a red bar graph is displayed on the head line of the display. An alarm message will be recorded and can be selected through the menu Messages (PATH: $\text{ISM}\backslash\text{Messages}$; see also chapter 9.2 "Messages").



NOTE: If the alarm has not been acknowledged the bar graph will blink. If the alarm has already been acknowledged, the bar graph will be displayed continuously. See also chapter 9.2 "Messages". In the case of an unacknowledged warning or alarm the transmitter screen will not be dimmed or switched off even if the light time has been elapsed (see chapter 8.9 "Display Setup").



NOTE: If at the same time a channel has born an alarm and a warning indicated, the indication of the alarm will have higher priority. The alarm will be indicated (see chapter 13.5 "Warning- and Alarm Indication") on the Menu Screen or Start Screen, while the warning will not be shown.

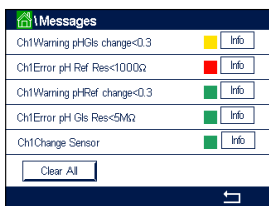

Pressing the red bar graph on the Menu Screen will lead to the Messages. Refer to chapter 9.2 "Messages" for the description of the functionality for this menu.



NOTE: The detection of some alarms can be activated/deactivated. Refer therefore to chapter 8.7 "ISM / Sensor Alarm".



NOTE: Alarms which are caused by a violation of the limitation of a setpoint or the range (PATH: $\text{CONFIG}\backslash\text{Set Points}$; see also chapter 8.4 "Set Points") will also be indicated on the display and recorded through the menu Messages (PATH: $\text{ISM}\backslash\text{Messages}$; see also chapter 9.2 "Messages").

14 Accessories and Spare Parts

Please contact your local Mettler-Toledo sales office or representative for details on additional accessories and spare parts.

Description	Order no.
Pipe Mount Kit for 1/2DIN models	52 500 212
Panel Mount Kit for 1/2DIN models	52 500 213
Protective Hood	300 733 28

15 Specifications

15.1 General specifications

For sensor specifications of ISM sensors refer to sensor manual.

Conductivity/resistive Specifications for Cond2e/Cond4e Sensors	
Conductivity range	– 2-electrode sensor: 0.02 to 2000 $\mu\text{S}/\text{cm}$ (500 $\Omega \times \text{cm}$ to 50 $\text{M}\Omega \times \text{cm}$) – 4-electrode sensor: 0.01 to 650 mS/cm (1.54 $\Omega \times \text{cm}$ to 0.1 $\text{M}\Omega \times \text{cm}$)
Display range for 2-e sensor	0 to 40,000 mS/cm (25 $\Omega \times \text{cm}$ to 100 $\text{M}\Omega \times \text{cm}$)
Display range for 4-e sensor	0.01 to 650 mS/cm (1.54 $\Omega \times \text{cm}$ to 0.1 $\text{M}\Omega \times \text{cm}$)
Cell constants	0.01/0.1/10
Chemical concentration curves	NaCl: 0–26% @ 0 °C to 0–28% @ +100 °C NaOH: 0–12% @ 0 °C to 0–16% @ +40 °C to 0–6% @ +100 °C HCl: 0–18% @ –20 °C to 0–18% @ 0 °C to 0–5% @ +50 °C HNO ₃ : 0–30% @ –20 °C to 0–30% @ 0 °C to 0–8% @ +50 °C H ₂ SO ₄ : 0–26% @ –12 °C to 0–26% @ +5 °C to 0–9% @ +100 °C H ₃ PO ₄ : 0–35% @ +5 °C to +80 °C User defined concentration curve table (5x5 matrix)
TDS ranges	NaCl, CaCO ₃
Sensor maximum distance	– ISM: 80 m (260 ft) – Analog: 61 m (200 ft); 15 m (50 ft with 4-E sensors)
Cond/Res accuracy	$\pm 0.5\%$ of reading or 0.25 Ω , whichever is greater, up to 10 $\text{M}\Omega\text{-cm}$
Cond/Res repeatability	$\pm 0.25\%$ of reading or 0.25 Ω , whichever is greater
Cond/Res resolution	Auto/0.001/0.01/0.1/1, can be selected
Temperature input	Pt1000/Pt100/NTC22K
Temperature measuring range	–40 to +200.0 °C (–40 to 392 °F)
Temperature resolution	Auto/0.001/0.01/0.1/1 K (°F), can be selected
Temperature accuracy	± 0.25 K (± 0.45 °F) within –30 to +150 °C ± 0.50 K (± 0.90 °F) outside

pH Specifications	
pH range	-2.00 to 16.00 pH
Sensor maximum distance	- ISM: 80 m (260 ft) - Analog: 10 to 20 m (33 to 65 ft) depending on sensor
pH resolution	Auto/0.01/0.1/1, can be selected
mV range	-1500 to 1500 mV
mV resolution	Auto/0.01/0.1/1 mV
mV accuracy	±1 mV
Temperature measuring range	-30 to 130 °C (-22 to 266 °F)
Temperature resolution	Auto/0.001/0.01/0.1/1 K (°F), can be selected
Temperature accuracy	± 0.25 K

Available Buffer Sets	
Standard buffers	
MT-9 buffers, MT-10 buffers, NIST Technical Buffers, NIST Standard Buffers (DIN 19266:2000-01), JIS Z 8802 buffers, Hach buffers, CIBA (94) buffers, Merck Titrisols-Reidel Fixanals, WTW buffers	
Dual membrane electrodes pH buffers (pH/pNa)	
Mettler-pH/pNa buffers (Na+ 3.9M)	

Specifications for Amperometric Oxygen Sensors	
Current range	0 to -7000 nA
Resolution current	6 pA
Max. sensor cable length	- ISM 80 m (260ft) - Analog: 20 m (65 ft)
DO concentration range	0 ppb (µg/l) to 50.00ppm (mg/l)
DO saturation range	0 to 500% air
O ₂ gas concentration range	0 to 9999 ppm O ₂ gas
O ₂ gas saturation range	0 to 100% O ₂ gas
Resolution	Auto/0.001/0.01/0.1/1, can be selected
Temperature measuring range	-30 to 150 °C (-22 to 302 °F)
Temperature resolution	Auto/0.001/0.01/0.1/1 K (°F), can be selected
Temperature accuracy	±0.25 K in the range of -10 to +80 °C (14 to +176°F)
Polarization voltage	-1000 to 0 mV
Temperature input	NTC 22 kΩ, Pt1000
Temperature compensation	Automatic
Calibration	- 1-point (slope or offset) calibration - Process calibration (slope or offset) calibration

Specifications for Optical Oxygen Sensors	
Sensor maximum distance	50 m (164 ft)
DO concentration range	0 ppb ($\mu\text{g/l}$) to 50.00ppm (mg/l)
DO saturation range	0 to 500% air, 0 to 100% O_2
Resolution	Auto/0.001/0.01/0.1/1, can be selected
Temperature measuring range	-30 to 150 °C (-22 to 302 °F)
Temperature resolution	Auto/0.001/0.01/0.1/1 K (°F), can be selected

Specifications for Turbidity Sensors	
Light source	Light-emitting diode (LED), emitting frequency 880 nm
Measurement range	<ul style="list-style-type: none"> - 5 to 4000 FTU (Formazin Turbidity Units) and 0 to 30 g/l suspended solids with InPro8200 - 10 to 4000 FTU and 0 to 250 g/l suspended solids with InPro8050 and InPro8100
Selectable measuring units	FTU, NTU, EBC, g/l, mg/l, %, ppm, DO
Parameter Sets	Three different parameter sets (A,B,C) can be stored in memory and recalled by software menu or remote access via digital inputs
Sensor diagnostics	Light Source (internal reference signal = 0)
Calibration	<ul style="list-style-type: none"> - Manual calibration "Edit": Offset and gain values for the sensor can be entered directly - Process calibration: Single-point grab-sample calibration (offset or slope: user-selectable) - Multi-point calibration (decreasing): 2-, 3-, 4- or 5-point automatic calibration (offset and gain will be adjusted automatically) - In-Situ Calibration (increasing): 2-, 3-, 4- or 5-point automatic calibration

Specifications Dissolved Carbon Dioxide Sensors	
CO ₂ measuring ranges	0 to 5000 mg/l 0 to 200 %sat 0 to 1500 mmHg 0 to 2000 mbar 0 to 2000 hPa
Sensor maximum distance	80 m (260 ft)
CO ₂ accuracy	±1 digit
CO ₂ resolution	auto/0.001/0.01/0.1/1, (can be selected)
mV range	-1500 to 1500 mV
mV resolution	auto/0.01/0.1/1 mV
mV accuracy	±1 digit
Total pressure range (TotPres)	0 to 4000 mbar
Temperature measuring range	-30 to 150 °C (-22 to 302 °F)
Temperature resolution	auto/0.001/0.01/0.1/1 K (°F), (can be selected)
Temperature accuracy	±1 digit
Temperature repeatability	±1 digit
Available Buffer Set:	
MT-9 buffers with solution pH = 7.00 and pH = 9.21 @ 25 °C	

15.2 Electrical specifications

Power requirements	100 to 240 V AC or 20 to 30 V DC, 10W, AWG 16–24, 0.2 mm ² to 1.5 mm ²
Frequency	50/60 Hz
Analog output signals	Eight 0/4 to 20 mA outputs, galvanically isolated from input and from earth/ground
Measurement error through analog outputs	< ±0.05 mA over 0 to 22 mA range
Analog output configuration	Linear, Bi-Linear, Logarithmic, Autoranging
Load	max. 500 Ω
Connection terminals	Spring cage terminals appropriate for AWG 16–24, 0.2 mm ² to 1.5 mm ² wires
Digital communication	USB port, Type B connector
PID process controller	2xPID; pulse length, pulse frequency or analog control
Cycle time	Ca. 1 second
Digital inputs	6 (5 for 2-channel version) with switching limits 0.00 VDC to 1.00 VDC for low level and 2.30 VDC to 30.00 VDC for high level
Analog inputs	One 4 to 20 mA input, galvanically isolated from other signals
Measurement error through analog input	< ±0.05 mA over 0 to 22 mA range
Mains power fuse	2.0 A slow blow type FC, not replaceable
Relays	4-SPST mechanical rated at 250 VAC, 3 Amps Relay1 NC, Relay2 to 4 NO 4-SPST Type Reed 250 VAC or DC, 0.5 A (Relay5 to 8)
Alarm Relay delay	0–999 s
User interface	Color touch screen 5.7" Resolution 320 x 240 pixel 256 colors
Max. cable length	80 m (260 ft) for pH, amp. oxygen, Cond4e, ozone 15 m (50 ft) for optical DO, UniCond2e



NOTE: This is a 4-wire-product with an active 4–20 mA analog output.
Please do not supply to terminal no. 3 to 10 of TB1 and terminal no. 1 to 8 of TB3.

15.3 Mechanical specifications

Dimensions (housing – H x W x D)*	150 x 158 x 170 mm (5.36" x 6.22" x 6.69")
Front bezel – H x W	150 x 158 mm (5.36" x 6.22")
Max. D – panel mounted	125 mm (4.92")
Weight	1.6 kg (3.5 lb)
Material	Polycarbonate / PC
Ingress rating	IP 66 (when back cover is attached)





* H = Height, W = Width, D = Depth





15.4 Environmental specifications

Storage temperature	-40 to 70 °C (-40 to 158 °F)
Ambient temperature operating range	-20 to 50 °C (-4 to 122 °F)
Relative humidity	0 to 95% non-condensing
Emissions	According to EN 61326 Class A
Hazardous areas	M800 2-Channel and 4-Channel only: cFMus Class I Division 2 M800 1-Channel, optical sensors InPro8100 and InPro8200 only: ATEX II (1)G [Ex opis Ga] IIA/IIB
CE mark	The measuring system is in conformity with the statutory requirements of the EC Directives. METTLER TOLEDO confirms successful testing of the device by affixing to it the CE mark. For CE Declaration of Conformity see supplied CD.
Ratings / Approvals	UL, ATEX
Altitude, maximum	5,000 m

15.5 Ex Classification

15.5.1 M800 4-Channel and 2-Channel versions

<p>Mettler-Toledo, Inc. Billerica, MA 01821, USA</p> <p>M800 2 Channel Process</p> <p>SN: 1231000000</p> <p>PN: 52121813</p> <p>Made by METTLER TOLEDO in China</p>	<p> US LISTED Measuring Equipment 26MR UL file #E203651 UL Type 4X</p> <p>Ambient Temp: -20 to 50 °C Fuse rating: 2.0A slow blow Type FC Power: 100-240V~,50/60 Hz,10W 20-30V~+,10W</p> <p>IP66    RoHS</p>	<p> APPROVED Entry thread: Metric, 2xM25,3xM20; See Manual.</p> <p>CL1, DIV2, Groups ABCD T4 ENCLOSURE TYPE 4X IP66</p> <p>WARNING - EXPLOSION HAZARD. DO NOT DISCONNECT WHILE CIRCUIT IS LIVE UNLESS AREA IS KNOWN TO BE NON-HAZARDOUS. AVERTISSEMENT - RISQUE D'EXPLOSION. NE PAS DEBRANCHER TANT QUE LE CIRCUIT EST SOUS TENSION, A MOINS QU'IL NE S'AGISSE D'UN EMPLACEMENT NON DANGEREUX.</p>
---	--	---

<p>Mettler-Toledo AG CH-8902 Urdorf, Switzerland</p> <p>M800 2 Channel Process</p> <p>SN: 1231000000</p> <p>PN: 52121813</p> <p>Made by METTLER TOLEDO in China</p>	<p> US LISTED Measuring Equipment 26MR UL file #E203651 UL Type 4X</p> <p>Ambient Temp: -20 to 50 °C Fuse rating: 2.0A slow blow Type FC Power: 100-240V~,50/60 Hz,10W 20-30V~+,10W</p> <p>IP66    RoHS</p>	<p> APPROVED Entry thread: Metric, 2xM25,3xM20; See Manual.</p> <p>CL1, DIV2, Groups ABCD T4 ENCLOSURE TYPE 4X IP66</p> <p>WARNING - EXPLOSION HAZARD. DO NOT DISCONNECT WHILE CIRCUIT IS LIVE UNLESS AREA IS KNOWN TO BE NON-HAZARDOUS. AVERTISSEMENT - RISQUE D'EXPLOSION. NE PAS DEBRANCHER TANT QUE LE CIRCUIT EST SOUS TENSION, A MOINS QU'IL NE S'AGISSE D'UN EMPLACEMENT NON DANGEREUX.</p>
---	--	---



NOTE: To fulfill the complete FM certification the conduit entry threads used must meet the following requirements: Minimum Class 1, Division 2, Groups A, B, C & D, Type 4X and IP66.



Installation shall comply with the relevant requirements of the National Electrical Code® (ANSI/NFPA-70 (NED®)) and the Canadian Electrical (CE) Code® (CEC, CAN/CSA-C22.1), where applicable.

Tampering and replacement with non-factory components may adversely affect the safe use of the system.

WARNING – EXPLOSION HAZARD. DO NOT REMOVE OR REPLACE WHILE PRESENT.

WARNING – EXPLOSION HAZARD. DO NOT DISCONNECT EQUIPMENT WHEN A FLAMMABLE OR COMBUSTIBLE ATMOSPHERE IS PRESENT.

WARNING – EXPLOSION HAZARD. DO NOT DISCONNECT WHILE CIRCUIT IS LIVE UNLESS AREA IS KNOWN TO BE NON-HAZARDOUS.

AVERTISSEMENT – RISQUE D’EXPLOSION. NE PAS DÉBRANCHER TANT QUE LE CIRCUIT EST SOUS TENSION, à MOINS QU’IL NE S’AGISSE D’UN EMPLACEMENT NON DANGEREUX.

15.5.2 Type plate M800 1-Channel versions

Ex-certification for optical sensors InPro8100 ans InPro8200 only.

Mettler-Toledo AG CH-8902 Urdorf, Switzerland M800 1 Channel Process SN: XXXXXXXXXXXX PN: 30026633 Made by METTLER TOLEDO in China	CE ¹²⁵⁸ RoHs
	II (1)G [Ex op is Ga] IIA/IIB SEV 12 ATEX 0169X
IP 66 Ambient Temp: -20 to 50°C Fuse rating: 2.0A slow blow Type FC Power: 100-240 V~, 50/60 Hz, 10W 20-30 V _{DC} , 10W	

16 Warranty

METTLER TOLEDO warrants this product to be free from significant deviations in material and workmanship for a period of one year from the date of purchase. If repair is necessary and not the result of abuse or misuse within the warranty period, please return by pre-paid freight and an amendment will be made without any charge. METTLER TOLEDO's Customer Service Dept. will determine if the product problem is due to deviations or customer abuse. Out-of-warranty products will be repaired on an exchange basis at cost.

The above warranty is the only warranty made by METTLER TOLEDO and is in lieu of all other warranties, expressed or implied, including, without limitation, implied warranties of merchantability and fitness for a particular purpose. METTLER TOLEDO shall not be liable for any loss, claim, expense or damage caused by, contributed to or arising out of the acts or omissions of the

Buyer or Third Parties, whether negligent or otherwise. In no event shall METTLER TOLEDO's liability for any cause of action whatsoever exceed the cost of the item giving rise to the claim, whether based in contract, warranty, indemnity, or tort (including negligence).

17 Buffer tables

M800 Transmitters have the ability to do automatic pH buffer recognition. The following tables show different buffers that are automatically recognized.

17.1 Standard pH buffers

17.1.1 Mettler-9

Temp (°C)	pH of buffer solutions			
0	2.03	4.01	7.12	9.52
5	2.02	4.01	7.09	9.45
10	2.01	4.00	7.06	9.38
15	2.00	4.00	7.04	9.32
20	2.00	4.00	7.02	9.26
25	2.00	4.01	7.00	9.21
30	1.99	4.01	6.99	9.16
35	1.99	4.02	6.98	9.11
40	1.98	4.03	6.97	9.06
45	1.98	4.04	6.97	9.03
50	1.98	4.06	6.97	8.99
55	1.98	4.08	6.98	8.96
60	1.98	4.10	6.98	8.93
65	1.98	4.13	6.99	8.90
70	1.99	4.16	7.00	8.88
75	1.99	4.19	7.02	8.85
80	2.00	4.22	7.04	8.83
85	2.00	4.26	7.06	8.81
90	2.00	4.30	7.09	8.79
95	2.00	4.35	7.12	8.77

17.1.2 Mettler-10

Temp (°C)	pH of buffer solutions				
0	2.03	4.01	7.12	10.65	
5	2.02	4.01	7.09	10.52	
10	2.01	4.00	7.06	10.39	
15	2.00	4.00	7.04	10.26	
20	2.00	4.00	7.02	10.13	
25	2.00	4.01	7.00	10.00	
30	1.99	4.01	6.99	9.87	
35	1.99	4.02	6.98	9.74	
40	1.98	4.03	6.97	9.61	
45	1.98	4.04	6.97	9.48	
50	1.98	4.06	6.97	9.35	
55	1.98	4.08	6.98		
60	1.98	4.10	6.98		
65	1.99	4.13	6.99		
70	1.98	4.16	7.00		
75	1.99	4.19	7.02		
80	2.00	4.22	7.04		
85	2.00	4.26	7.06		
90	2.00	4.30	7.09		
95	2.00	4.35	7.12		

17.1.3 NIST Technical Buffers

Temp (°C)	pH of buffer solutions				
0	1.67	4.00	7.115	10.32	13.42
5	1.67	4.00	7.085	10.25	13.21
10	1.67	4.00	7.06	10.18	13.01
15	1.67	4.00	7.04	10.12	12.80
20	1.675	4.00	7.015	10.07	12.64
25	1.68	4.005	7.00	10.01	12.46
30	1.68	4.015	6.985	9.97	12.30
35	1.69	4.025	6.98	9.93	12.13
40	1.69	4.03	6.975	9.89	11.99
45	1.70	4.045	6.975	9.86	11.84
50	1.705	4.06	6.97	9.83	11.71
55	1.715	4.075	6.97		11.57
60	1.72	4.085	6.97		11.45
65	1.73	4.10	6.98		
70	1.74	4.13	6.99		
75	1.75	4.14	7.01		
80	1.765	4.16	7.03		
85	1.78	4.18	7.05		
90	1.79	4.21	7.08		
95	1.805	4.23	7.11		

17.1.4 NIST standard buffers (DIN and JIS 19266: 2000–01)

Temp (°C)	pH of buffer solutions			
0				
5	1.668	4.004	6.950	9.392
10	1.670	4.001	6.922	9.331
15	1.672	4.001	6.900	9.277
20	1.676	4.003	6.880	9.228
25	1.680	4.008	6.865	9.184
30	1.685	4.015	6.853	9.144
37	1.694	4.028	6.841	9.095
40	1.697	4.036	6.837	9.076
45	1.704	4.049	6.834	9.046
50	1.712	4.064	6.833	9.018
55	1.715	4.075	6.834	8.985
60	1.723	4.091	6.836	8.962
70	1.743	4.126	6.845	8.921
80	1.766	4.164	6.859	8.885
90	1.792	4.205	6.877	8.850
95	1.806	4.227	6.886	8.833



NOTE: The pH(S) values of the individual charges of the secondary reference materials are documented in a certificate of an accredited laboratory. This certificate is supplied with the respective buffer materials. Only these pH(S) values shall be used as standard values for the secondary reference buffer materials. Correspondingly, this standard does not include a table with standard pH values for practical use. The table above only provides examples of pH(PS) values for orientation.

17.1.5 Hach buffers

Buffer values up to 60 °C as specified by Bergmann & Beving Process AB.

Temp (°C)	pH of buffer solutions		
0	4.00	7.14	10.30
5	4.00	60	10.23
10	4.00	7.04	10.11
15	4.00	7.04	10.11
20	4.00	7.02	10.05
25	4.01	7.00	10.00
30	4.01	6.99	9.96
35	4.02	6.98	9.92
40	4.03	6.98	9.88
45	4.05	6.98	9.85
50	4.06	6.98	9.82
55	4.07	6.98	9.79
60	4.09	6.99	9.76

17.1.6 Ciba (94) buffers

Temp (°C)	pH of buffer solutions				
0	2.04	4.00	7.10	10.30	
5	2.09	4.02	7.08	10.21	
10	2.07	4.00	7.05	10.14	
15	2.08	4.00	7.02	10.06	
20	2.09	4.01	6.98	9.99	
25	2.08	4.02	6.98	9.95	
30	2.06	4.00	6.96	9.89	
35	2.06	4.01	6.95	9.85	
40	2.07	4.02	6.94	9.81	
45	2.06	4.03	6.93	9.77	
50	2.06	4.04	6.93	9.73	
55	2.05	4.05	6.91	9.68	
60	2.08	4.10	6.93	9.66	
65	2.07*	4.10*	6.92*	9.61*	
70	2.07	4.11	6.92	9.57	
75	2.04*	4.13*	6.92*	9.54*	
80	2.02	4.15	6.93	9.52	
85	2.03*	4.17*	6.95*	9.47*	
90	2.04	4.20	6.97	9.43	
95	2.05*	4.22*	6.99*	9.38*	

* Extrapolated

17.1.7 Merck Titrisole, Riedel-de-Haën Fixanale

Temp (°C)	pH of buffer solutions				
0	2.01	4.05	7.13	9.24	12.58
5	2.01	4.05	7.07	9.16	12.41
10	2.01	4.02	7.05	9.11	12.26
15	2.00	4.01	7.02	9.05	12.10
20	2.00	4.00	7.00	9.00	12.00
25	2.00	4.01	6.98	8.95	11.88
30	2.00	4.01	6.98	8.91	11.72
35	2.00	4.01	6.96	8.88	11.67
40	2.00	4.01	6.95	8.85	11.54
45	2.00	4.01	6.95	8.82	11.44
50	2.00	4.00	6.95	8.79	11.33
55	2.00	4.00	6.95	8.76	11.19
60	2.00	4.00	6.96	8.73	11.04
65	2.00	4.00	6.96	8.72	10.97
70	2.01	4.00	6.96	8.70	10.90
75	2.01	4.00	6.96	8.68	10.80
80	2.01	4.00	6.97	8.66	10.70
85	2.01	4.00	6.98	8.65	10.59
90	2.01	4.00	7.00	8.64	10.48
95	2.01	4.00	7.02	8.64	10.37

17.1.8 WTW buffers

Temp (°C)	pH of buffer solutions			
0	2.03	4.01	7.12	10.65
5	2.02	4.01	7.09	10.52
10	2.01	4.00	7.06	10.39
15	2.00	4.00	7.04	10.26
20	2.00	4.00	7.02	10.13
25	2.00	4.01	7.00	10.00
30	1.99	4.01	6.99	9.87
35	1.99	4.02	6.98	9.74
40	1.98	4.03	6.97	9.61
45	1.98	4.04	6.97	9.48
50	1.98	4.06	6.97	9.35
55	1.98	4.08	6.98	
60	1.98	4.10	6.98	
65	1.99	4.13	6.99	
70		4.16	7.00	
75		4.19	7.02	
80		4.22	7.04	
85		4.26	7.06	
90		4.30	7.09	
95		4.35	7.12	

17.1.9 JIS Z 8802 buffers

Temp (°C)	pH of buffer solutions			
0	1.666	4.003	6.984	9.464
5	1.668	3.999	6.951	9.395
10	1.670	3.998	6.923	9.332
15	1.672	3.999	6.900	9.276
20	1.675	4.002	6.881	9.225
25	1.679	4.008	6.865	9.180
30	1.683	4.015	6.853	9.139
35	1.688	4.024	6.844	9.102
38	1.691	4.030	6.840	9.081
40	1.694	4.035	6.838	9.068
45	1.700	4.047	6.834	9.038
50	1.707	4.060	6.833	9.011
55	1.715	4.075	6.834	8.985
60	1.723	4.091	6.836	8.962
70	1.743	4.126	6.845	8.921
80	1.766	4.164	6.859	8.885
90	1.792	4.205	6.877	8.850
95	1.806	4.227	6.886	8.833

17.2 Dual membrane pH electrode buffers

17.2.1 Mettler-pH/pNa buffers (Na+ 3.9M)

Temp (°C)	pH of buffer solutions			
0	1.98	3.99	7.01	9.51
5	1.98	3.99	7.00	9.43
10	1.99	3.99	7.00	9.36
15	1.99	3.99	6.99	9.30
20	1.99	4.00	7.00	9.25
25	2.00	4.01	7.00	9.21
30	2.00	4.02	7.01	9.18
35	2.01	4.04	7.01	9.15
40	2.01	4.05	7.02	9.12
45	2.02	4.07	7.03	9.11
50	2.02	4.09	7.04	9.10

Sales and Service:

Australia

Mettler-Toledo Ltd.
220 Turner Street
Port Melbourne
AU-3207 Melbourne/VIC
Phone +61 1300 659 761
e-mail info.mtaus@mt.com

Austria

Mettler-Toledo Ges.m.b.H.
Südrandstraße 17
AT-1230 Wien
Phone +43 1 604 19 80
e-mail infoprocess.mtat@mt.com

Brazil

Mettler-Toledo Ind. e Com. Ltda.
Avenida Tamboré, 418
Tamboré
BR-06460-000 Barueri/SP
Phone +55 11 4166 7400
e-mail mettler@mettler.com.br
service@mettler.com.br

China

Mettler-Toledo Instruments
(Shanghai) Co. Ltd.
589 Gui Ping Road
Cao He Jing
CN-200233 Shanghai
Phone +86 21 64 85 04 35
e-mail mtcs@public.sta.net.cn

Croatia

Mettler-Toledo d.o.o.
Mandlova 3
HR-10000 Zagreb
Phone +385 1 292 06 33
e-mail mt.zagreb@mt.com

Czech Republic

Mettler-Toledo s.r.o.
Trebohosticka 2283/2
CZ-100 00 Praha 10
Phone +420 2 72 123 150
e-mail sales.mtcz@mt.com

Denmark

Mettler-Toledo A/S
Naverland 8
DK-2600 Glostrup
Phone +45 43 27 08 00
e-mail info.mtdk@mt.com

France

Mettler-Toledo
Analyse Industrielle S.A.S.
30, Boulevard de Douaumont
FR-75017 Paris
Phone +33 1 47 37 06 00
e-mail mtpro-f@mt.com

Germany

Mettler-Toledo GmbH
Prozeßanalytik
Ockerweg 3
DE-35396 Gießen
Phone +49 641 507 444
e-mail prozess@mt.com

Great Britain

Mettler-Toledo LTD
64 Boston Road, Beaumont Leys
GB-Leicester LE4 1AW
Phone +44 116 235 7070
e-mail enquire.mtuk@mt.com

Hungary

Mettler-Toledo Kereskedelmi KFT
Teve u. 41
HU-1139 Budapest
Phone +36 1 288 40 40
e-mail mthu@axelero.hu

India

Mettler-Toledo India Private Limited
Amar Hill, Saki Vihar Road
Powai
IN-400 072 Mumbai
Phone +91 22 2857 0808
e-mail sales.mtin@mt.com

Indonesia

PT. Mettler-Toledo Indonesia
GRHA PERSADA 3rd Floor
Jl. KH. Noer Ali No.3A,
Kayuringin Jaya
Kalimalang, Bekasi 17144, ID
Phone +62 21 294 53919
e-mail
mt-id.customersupport@mt.com

Italy

Mettler-Toledo S.p.A.
Via Vialba 42
IT-20026 Novate Milanese
Phone +39 02 333 321
e-mail
customercare.italia@mt.com

Japan

Mettler-Toledo K.K.
Process Division
6F Ikenohata Nisshoku Bldg.
2-9-7, Ikenohata
Taito-ku
JP-110-0008 Tokyo
Phone +81 3 5815 5606
e-mail helpdesk.ing.jp@mt.com

Malaysia

Mettler-Toledo (M) Sdn Bhd
Bangunan Electrocon Holding, U 1-01
Lot 8 Jalan Astaka U8/84
Seksyen U8, Bukit Jelutong
MY-40150 Shah Alam Selangor
Phone +60 3 78 44 58 88
e-mail
MT-MY.CustomerSupport@mt.com

Mexico

Mettler-Toledo S.A. de C.V.
Ejercito Nacional #340
Col. Chapultepec Morales
Del. Miguel Hidalgo
MX-11570 México D.F.
Phone +52 55 1946 0900
e-mail ventas.lab@mt.com

Norway

Mettler-Toledo AS
Ulvenveien 92B
NO-0581 Oslo Norway
Phone +47 22 30 44 90
e-mail info.mtn@mt.com

Poland

Mettler-Toledo (Poland) Sp.z.o.o.
ul. Poleczki 21
PL-02-822 Warszawa
Phone +48 22 545 06 80
e-mail polska@mt.com

Russia

Mettler-Toledo Vostok ZAO
Sretenskij Bulvar 6/1
Office 6
RU-101000 Moscow
Phone +7 495 621 56 66
e-mail inforus@mt.com

Singapore

Mettler-Toledo (S) Pte. Ltd.
Block 28
Ayer Rajah Crescent #05-01
SG-139959 Singapore
Phone +65 6890 00 11
e-mail precision@mt.com

Slovakia

Mettler-Toledo s.r.o.
Hattalova 12/A
SK-831 03 Bratislava
Phone +421 2 4444 12 20-2
e-mail predaj@mt.com

Slovenia

Mettler-Toledo d.o.o.
Pot heroja Trtnika 26
SI-1261 Ljubljana-Dobrunje
Phone +386 1 530 80 50
e-mail keith.racman@mt.com

South Korea

Mettler-Toledo (Korea) Ltd.
Yeil Building 1 & 2 F
124-5, YangJe-Dong
SeCho-Ku
KR-137-130 Seoul
Phone +82 2 3498 3500
e-mail Sales_MTKR@mt.com

Spain

Mettler-Toledo S.A.E.
C/Miguel Hernández, 69-71
ES-08908 L'Hospitalet de Llobregat
(Barcelona)
Phone +34 902 32 00 23
e-mail mtemkt@mt.com

Sweden

Mettler-Toledo AB
Virkesvägen 10
Box 92161
SE-12008 Stockholm
Norway Phone +46 8 702 50 00
e-mail sales.mts@mt.com

Switzerland

Mettler-Toledo (Schweiz) GmbH
Im Langacher
Postfach
CH-8606 Greifensee
Phone +41 44 944 45 45
e-mail salesola.ch@mt.com

Thailand

Mettler-Toledo (Thailand) Ltd.
272 Soi Soonvijai 4
Rama 9 Rd., Bangkokpi
Huay Kwang
TH-10320 Bangkok
Phone +66 2 723 03 00
e-mail
MT-TH.CustomerSupport@mt.com

Turkey

Mettler Toledo
Ölçüm Aletleri Ticaret
Satış ve Servis Hizmetleri A.Ş.
Haluk Türksoy Sokak No: 6 Zemin ve 1.
Bodrum Kat 34662 Üsküdar-İstanbul, TR
Phone +90 216 400 20 20
e-mail sales.mtr@mt.com

USA/Canada

METTLER TOLEDO
Process Analytics
900 Middlesex Turnpike, Bld. 8
Billerica, MA 01821, USA
Phone +1 781 301 8800
Freephone +1 800 352 8763
e-mail mtprous@mt.com



Management System
certified according to
ISO 9001 / ISO 14001

Subject to technical changes.
© Mettler-Toledo AG, Process Analytics
09/2015 Printed in Switzerland. 52 121 825

Mettler-Toledo AG, Process Analytics
Im Hackacker 15, CH-8902 Urdorf, Switzerland
Tel. +41 44 729 62 11, Fax +41 44 729 66 36

www.mt.com/pro