

# Moisture Analyzer HB43-S

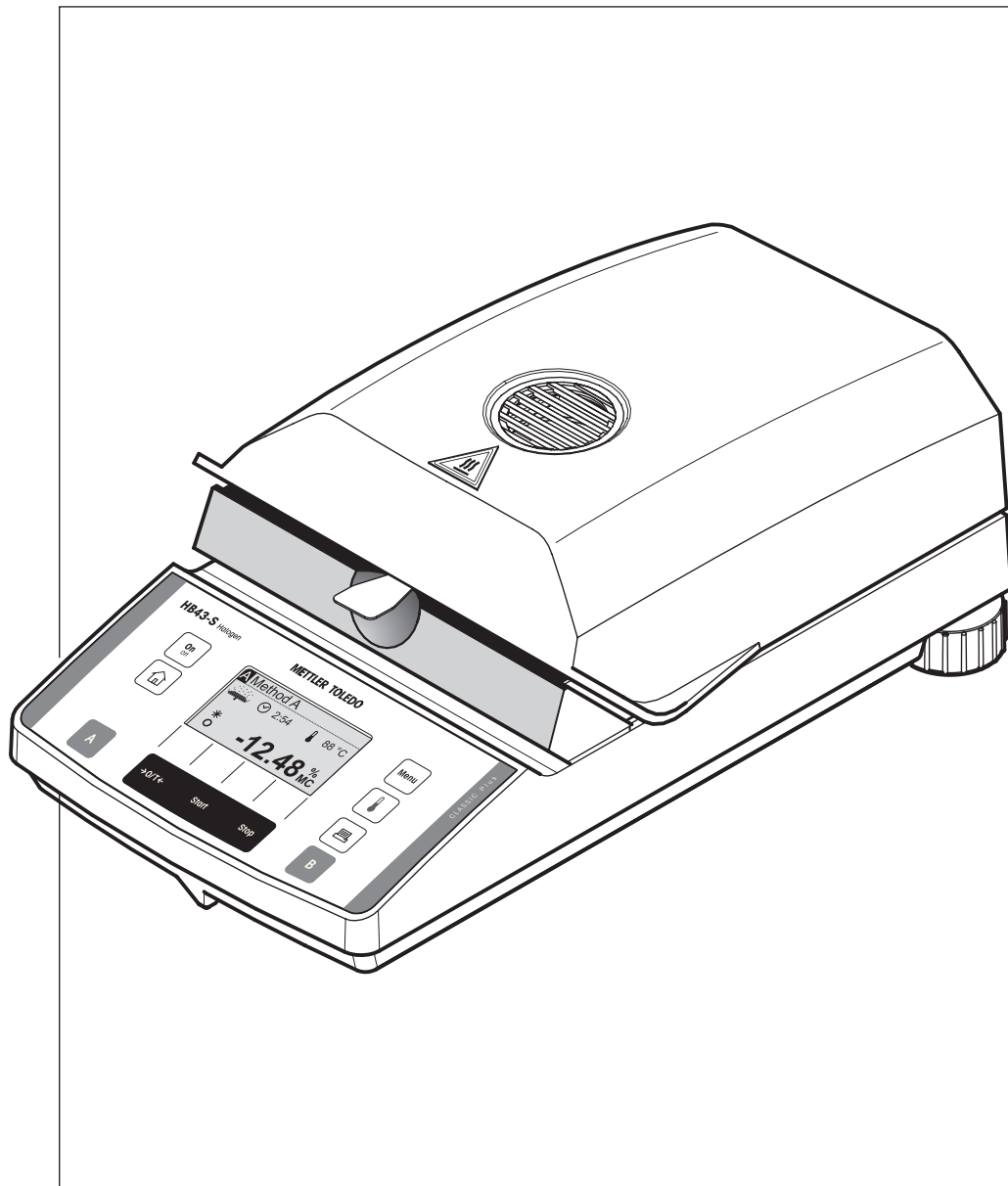

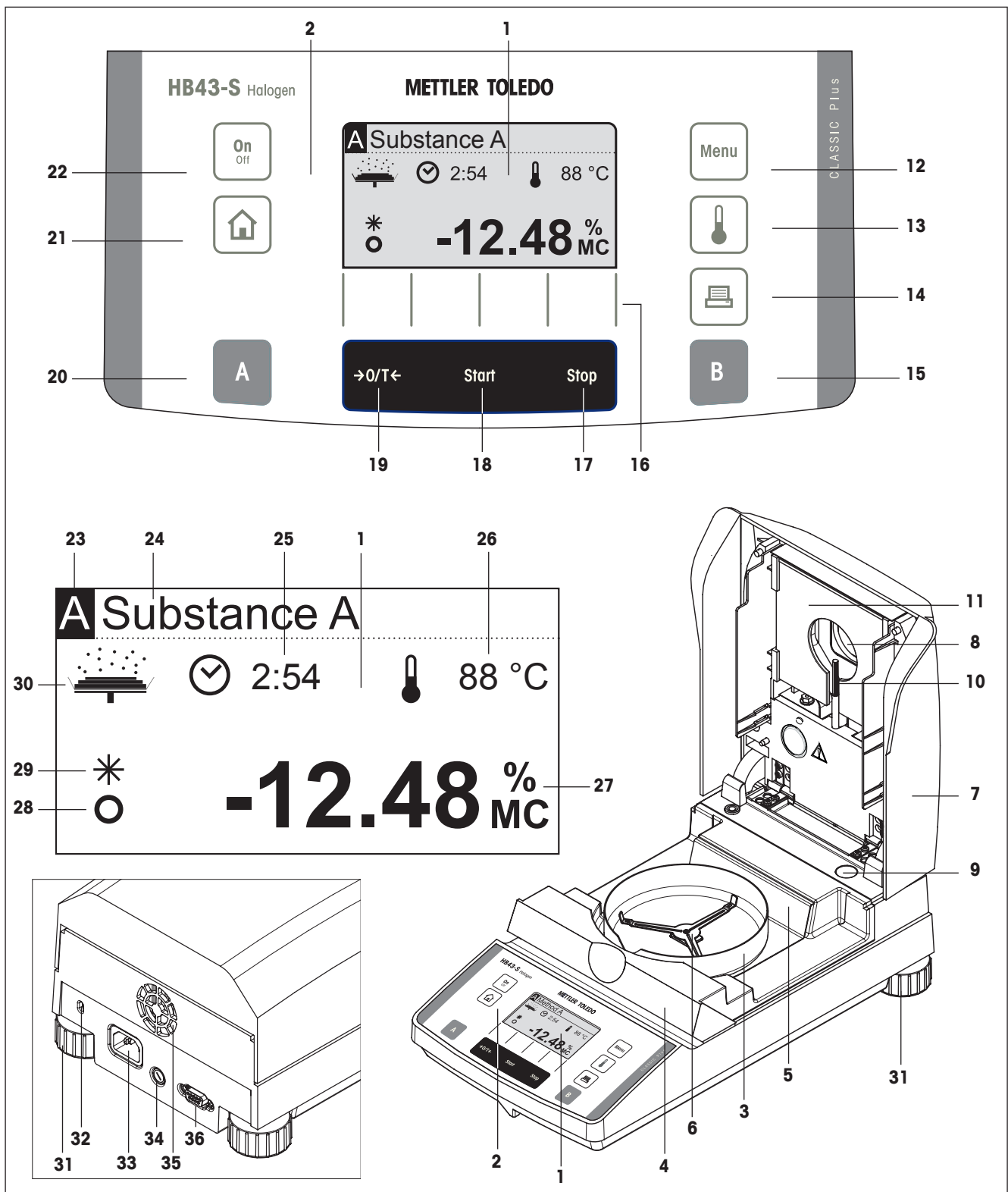

**METTLER TOLEDO**

# Overview of your HB43-S Halogen Moisture Analyzer



## Display, controls and connections of your HB43-S

No.	Designation	Info see section
<b>1</b>	Display (example)	all
<b>2</b>	Keypad	all
<b>3</b>	Draft shield	2.3
<b>4</b>	Sample chamber	2.3/6.1
<b>5</b>	Heat shield	2.3
<b>6</b>	Sample pan support	2.3/2.4
<b>7</b>	Heating module	1.2/5.4
<b>8</b>	Inspection window and vent	5.4
<b>9</b>	Level indicator (level)	2.3
<b>10</b>	Temperature sensor	6.1
<b>11</b>	Halogen lamp protective glass	6.1
<b>12</b>	Key «Menu»	4/5
<b>13</b>	Key «Drying temperature»	4.4.4.1
<b>14</b>	Key «  » (Print)	4.4/5.1
<b>15</b>	Key «B» (for choosing method B)	4.3/4.4
<b>16</b>	Softkeys (context-dependent keys)	4.2
<b>17</b>	Key «Stop» (stop drying)	4.5
<b>18</b>	Key «Start» (start of drying)	5.6.8
<b>19</b>	Key « $\leftrightarrow$ O/T $\leftrightarrow$ » (Zero/Tare)	2.4
<b>20</b>	Key «A» (for choosing method A)	4.3/4.4
<b>21</b>	Key «  » (for exiting the menu or stopping drying)	4.2/4.5
<b>22</b>	Key «On/Off»	2.4/4.5
<b>23</b>	Active method (A or B)	4.3/4.5
<b>24</b>	Name of method	4.4.1
<b>25</b>	Display of drying time	2.4/4.4.8
<b>26</b>	Display of drying temperature	2.4/4.4.4
<b>27</b>	Display of drying result	2.4/4.5
<b>28</b>	Stability detector	7.1/7.2

No.	Designation	Info see section
<b>29</b>	Symbol for calculated result	2.4
<b>30</b>	Status display ("User Guide")	2.4
<b>31</b>	Leveling screw	2.3
<b>32</b>	Antitheft device socket	2.3
<b>33</b>	Power supply receptacle	2.3
<b>34</b>	Power line fuse	6.2
<b>35</b>	Fan	1.3
<b>36</b>	RS232C interface connection	6.3/8.2

# Contents

<b>1</b>	<b>Getting to know your Moisture Analyzer</b>	<b>6</b>
1.1	Introduction	6
1.2	What is the Halogen Moisture Analyzer used for	6
1.3	Safety has priority	7
1.4	Important information about these instructions	9
1.5	Disposal	9
1.6	Finding More Information	9
<b>2</b>	<b>Your first measurement in next to no time</b>	<b>10</b>
2.1	Unpacking and checking the standard equipment	10
2.2	Selecting the location	11
2.3	Setting up, leveling and connecting to power supply	11
2.4	Your first measurement	13
<b>3</b>	<b>How to obtain the best results</b>	<b>17</b>
3.1	Measurement principle of the Halogen Moisture Analyzer	17
3.2	Notes on adjustment of the balance and the heating module	18
3.3	Optimum sample preparation	19
<b>4</b>	<b>Practical application of your Moisture Analyzer</b>	<b>20</b>
4.1	The operating concept and methods	20
4.2	The menu	21
4.3	Choosing and allocating methods from database	21
4.4	Developing own methods and defining parameters	23
4.4.1	Specifying name of method	23
4.4.2	Specifying target weight of sample	24
4.4.3	Selecting the drying program	25
4.4.4	Setting the drying temperature	25
4.4.4.1	Setting the drying temperature directly	26
4.4.5	Temperature reduction	26
4.4.6	Selecting the switch-off criterion	27
4.4.7	Setting time interval for free switch-off criterion	29
4.4.8	Setting drying time for timed switch-off	29
4.4.9	Selecting the display mode	29
4.4.10	Activating free factor	31
4.4.11	Specifying free factor	31
4.4.12	Choosing number of decimal places	32
4.4.13	Saving new method and exiting menu	32
4.4.14	Printing out records of methods	33
4.5	Performing a measurement	33
4.6	Information on the measurement record	37
<b>5</b>	<b>Basic settings of the instrument</b>	<b>38</b>
5.1	Menu overview	38
5.2	Testing the moisture analyzer with SmartCal	39
5.3	Adjusting the balance	41
5.4	Adjusting the heating module	43

5.5	Selecting the dialog language .....	45
5.6	System settings .....	46
5.6.1	Setting the time .....	46
5.6.2	Entering the date .....	46
5.6.3	Choosing time format .....	47
5.6.4	Choosing date format .....	47
5.6.5	Setting display contrast .....	47
5.6.6	Setting display brightness .....	47
5.6.7	How to activate the protection of menu settings .....	48
5.6.8	Selecting the start mode for drying .....	48
5.6.9	Switching the printer on or off .....	49
5.6.10	Defining the print interval .....	49
5.7	Interface settings .....	50
5.7.1	Setting the baud rate (data transmission speed) .....	50
5.7.2	Setting bit / parity .....	50
5.7.3	Setting the data flow control ("Handshake") .....	51
5.8	Resetting to the factory settings .....	51
<b>6</b>	<b>Servicing and replacing individual parts.....</b>	<b>52</b>
6.1	Cleaning the heating module and the sample chamber .....	52
6.2	Replacing the power line fuse .....	53
6.3	Connecting to an external printer .....	54
<b>7</b>	<b>If problems arise on occasion .....</b>	<b>55</b>
7.1	Error messages .....	55
7.1.1	Input errors .....	55
7.1.2	Application errors .....	55
7.1.3	Function errors .....	56
7.2	What if...? .....	57
<b>8</b>	<b>Further useful information .....</b>	<b>59</b>
8.1	Notes on interpretation of the measurement results and the ideal sample weight .....	59
8.2	RS232C interface .....	59
8.3	Application Brochure .....	59
8.4	Switch-off criterion "Weight loss per unit of time" .....	60
8.5	Technical data .....	61
8.6	MT-SICS Interface commands and functions .....	64
8.7	Accessories, consumables and spare parts .....	65
8.7.1	Accessories .....	65
8.7.2	Consumables .....	66
8.7.3	Spare parts .....	67
<b>9</b>	<b>Index .....</b>	<b>68</b>

# 1 Getting to know your Moisture Analyzer

Please read through this section carefully, it contains important information for safe and economical operation of your Moisture Analyzer.

## 1.1 Introduction

Thank you for deciding to purchase a Halogen Moisture Analyzer from METTLER TOLEDO – you have made a wise choice. Your Moisture Analyzer is fast and reliable. It offers a high level of operating convenience and useful functions to facilitate determination of the moisture content of your samples.

Behind your instrument stands METTLER TOLEDO, a leading manufacturer of not only balances and scales for the lab and production, but also analytical measuring instruments. A customer service network covering the entire globe with well trained personnel is at your service at all times, whether you are choosing accessories or require guidance for a specific application to ensure optimum utilization of your instrument.

To ensure you make full use of the possibilities offered by your Moisture Analyzer, we advise you to read through these operating instructions very carefully.

The operating instructions are based on the initially installed firmware (software) version V 2.00.

## 1.2 What is the Halogen Moisture Analyzer used for

Your Halogen Moisture Analyzer is used for determining the moisture content of almost any substance. The instrument works on the thermogravimetric principle. At the start of the measurement the Moisture Analyzer determines the weight of the sample, the sample is then quickly heated by the integral halogen heating module and the moisture vaporizes. During the drying process the instrument continually measures the weight of the sample and displays the reduction in moisture. Once drying has been completed, the moisture or solids content of your sample is displayed as the final result.

Of decisive importance in practice is the rate of heating and even heating of the surface of the sample. In comparison with conventional infrared heating or the drying oven method, for example, the halogen heating module of your instrument needs a shorter time to reach its maximum heating power. It also allows use of high temperatures, an additional factor in shortening the drying time. Uniform heating of the sample material ensures good repeatability of the drying results and makes it possible to use a smaller amount of sample.

All parameters of a measurement (drying temperature, drying time, etc.) can be preselected. But your Moisture Analyzer offers many other possibilities. To avoid exceeding the scope of this introduction, only a few of these are listed here:

- The built-in database contains predefined drying methods for many products. You can easily adjust the parameters of the individual methods to suit your needs.
- The drying process can be adjusted to suit the type of sample
- You can choose between various types of result display
- Your settings and the measurement results can be recorded
- Your settings are protected even if there is a power failure
- The RS232C data interface fitted as standard allows your moisture analyzer to communicate with an external printer or with a computer.

This wealth of functions notwithstanding, your Moisture Analyzer is very simple to operate. The status display (User Guide) guides you step by step through the measurement cycle and you always know which particular stage in a measurement is currently being executed by the instrument and the next operating step. To exclude faulty handling in routine work, the keypad can be locked to prevent access to all but the elementary functions.

The Moisture Analyzer conforms with all common standards and directives. It supports stipulations, work techniques and result records as demanded by all international quality assurance systems, e.g. **GLP (Good Laboratory Practice)**, **GMP (Good Manufacturing Practice)**. The instrument has a EC declaration of conformity and METTLER TOLEDO as the manufacturer has been awarded ISO 9001 and ISO 14001 certification. This provides you with the assurance that your capital investment is protected in the long term by a high product quality and a comprehensive service package (repairs, maintenance, servicing, adjustment service).

### 1.3 Safety has priority



Your Moisture Analyzer employs state of the art technology and meets the latest demands regarding instrument safety. This notwithstanding, improper operation can endanger personnel and cause damage to tangibles. For safe and dependable operation, please comply with the following instructions:

- The Moisture Analyzer is used for determining the moisture in samples. Please use the instrument exclusively for this purpose. Any other type of use can endanger personnel and damage the instrument or other tangibles.



- The Moisture Analyzer must not be operated in a hazardous environment and only under the ambient conditions specified in these instructions.

- The Moisture Analyzer may be operated only by trained personnel who are familiar with the properties of the samples used and with the handling of the instrument.

- Your Moisture Analyzer is supplied with a 3-pin power cable with an equipment grounding conductor. Only extension cables which meet the relevant standards and also have an equipment grounding conductor may be used. Intentional disconnection of the equipment grounding conductor is prohibited.

**Note:** There are two versions of the instrument, 110 VAC and 230 VAC.



#### **The Halogen Moisture Analyzer works with heat!**

- Ensure sufficient free space around the instrument to avoid heat accumulation and overheating (approx. 1 m free space above the instrument).

- The vent over the sample must never be covered, plugged, taped over or tampered with in any other way. This also applies to the fan on the back of the instrument.

- Do not place any combustible materials on, under or next to the instrument when it is connected to the power supply, since the area around the heating module becomes hot.

- Exercise caution when removing the sample. The sample itself, the sample chamber, the draft shield, and sample container (if used) may still be very hot.

- Be very careful if you open the heating module during operation, because the circular heating module or its protective glass can be as hot as 400 °C! For this reason, only ever touch the handles provided on the heating module.

- No modifications must be made within the heating module. It is particularly dangerous to bend any components or remove them, or to make any other changes.

### **Certain samples require special care!**

With certain types of samples, there is a possibility of danger to personnel or damage to tangibles through:



#### **Fire or explosion**

- Flammable or explosive substances
- Substances containing solvents
- Substances which evolve flammable or explosive gases or vapors when heated.

With such samples, work at a drying temperature that is low enough to prevent the formation of flames or an explosion and wear protective goggles. Should there be any uncertainty regarding the flammability of a sample, always work with a small amounts of sample (max. 1 gram). In such cases, **never leave** the instrument **unattended!** In cases of doubt, perform a careful risk analysis.

#### **Poisoning, burning**

- Substances which contain toxic or caustic components. Such substances may be dried only in a fume cupboard.

#### **Corrosion**

- Substances which evolve corrosive vapors when heated (e.g. acids). In the case of such substances, we advise you to work with small amounts of sample as the vapor can condense on cooler housing parts and cause corrosion.

Please note that the user always takes responsibility and assumes liability for damage caused by use of the types of samples mentioned above!

- Never make any modifications or constructional alterations to the instrument and use only original spare parts and accessories from METTLER TOLEDO.
- Your Moisture Analyzer is a rugged precision instrument – but you should still treat it carefully; it will then thank you with many years of trouble-free operation.
- Please comply with all notes and instructions in these operating instructions. Keep the instructions in a safe place where they are immediately to hand if any points are unclear. If you lose these instructions, please contact your METTLER TOLEDO dealer for an immediate replacement.



**Moisture determination applications must be optimized and validated by the user according to local regulations. Application-specific data provided by METTLER TOLEDO is intended for guidance only.**



## 1.4 Important information about these instructions

These instructions guide you step by step through the operation of your Moisture Analyzer. The first two sections help you put the instrument into operation quickly, safely and properly and perform your first measurement within a short space of time. In sections 3 through 5 you become intimately acquainted with the wide range of functions of your Moisture Analyzer. During this learning phase, you will find the table of contents and the detailed index in section 9 a valuable orientation aid. Sections 6 through 8 contain additional information on the maintenance of your instrument, troubleshooting and the available options. As soon as you are familiar with your Moisture Analyzer, you will find the illustrations at the beginning of these instructions and the associated references (in the key) useful for quick access.

The following identifications and symbols are used in these instructions:



- Key designations are shown enclosed by twin angle brackets «», e.g. «On/Off» or «».
- This symbol indicates safety and hazard instructions. If these are not complied with, injury to the user, damage to your instrument or other tangibles and malfunctions can result.

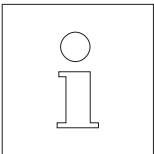

- This symbol indicates additional information and directions which facilitate your handling of the instrument and contribute to proper and economical use.

These instructions are also available in foreign languages. Should you require a set of instructions in a different language, please contact your METTLER TOLEDO dealer.

## 1.5 Disposal



In conformance with the European Directive 2002/96/EC on Waste Electrical and Electronic Equipment (WEEE) this device may not be disposed of in domestic waste. This also applies to countries outside the EU, per their specific requirements.

Please dispose of this product in accordance with local regulations at the collecting point specified for electrical and electronic equipment.

If you have any questions, please contact the responsible authority or the distributor from which you purchased this device.

Should this device be passed on to other parties (for private or professional use), the content of this regulation must also be related.

Thank you for your contribution to environmental protection.

## 1.6 Finding More Information

Internet <http://www.mt.com/moisture>

## 2 Your first measurement in next to no time

In the section you will learn how to put your new Moisture Analyzer into operation and obtain measurement results within a very short space of time.

### 2.1 Unpacking and checking the standard equipment

Open the package and remove the instrument and the accessories. Check the completeness of the delivery. The following accessories are part of the standard equipment of your new Moisture Analyzer:

- 80 aluminum sample pans
- 1 sample pan support
- 1 sample pan handler
- 1 specimen sample (circular, absorbent glass fiber filter)
- 1 draft shield
- 1 power cable
- 1 Operating instructions
- 1 Application brochure "Guide to Moisture Analysis"
- 1 List of predefined methods
- 1 EC declaration of conformity

Remove the wrapping from the instrument.

Check the instrument for transport damage. Immediately inform your METTLER TOLEDO dealer if you have any complaints or parts are missing.

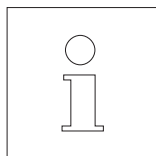

Store all parts of the packaging. This packaging guarantees the best possible protection for the transport of your instrument.

## 2.2 Selecting the location

Your Moisture Analyzer is a precision instrument. An optimum location guarantees accuracy and dependability:

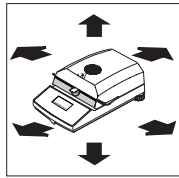
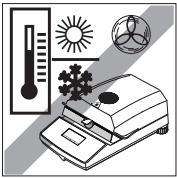
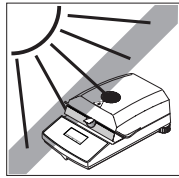
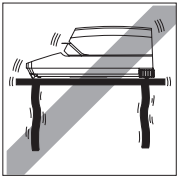

- Firm, horizontal location as free from vibrations as possible
- Avoid direct sunlight
- No excessive temperature fluctuations
- No powerful drafts
- Surroundings as free from dust as possible
- Enough space around the instrument to prevent build-up of heat
- Sufficient distance from heat-sensitive materials in the vicinity of the instrument.

## 2.3 Setting up, leveling and connecting to power supply

Exact horizontal positioning and stable installation are prerequisites for repeatable results. To compensate for small irregularities or inclinations ( $\pm 2\%$ ) at the location, the instrument can be leveled.

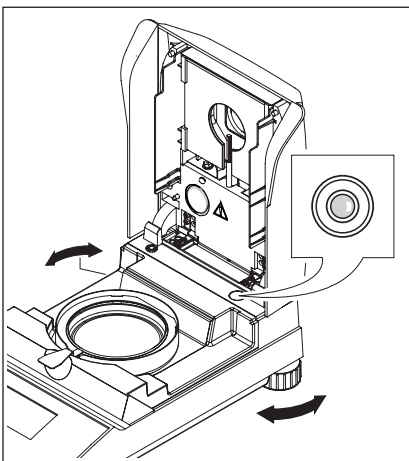

For exact horizontal positioning, the Moisture Analyzer has a level indicator (level) and 2 leveling screws. When the air bubble in the level indicator is exactly in the center, the instrument is standing perfectly horizontally. To level it, proceed as follows:

Position your Moisture Analyzer at the selected location.

Turn the two leveling screws until the air bubble is in the center of the level indicator.

**Note:** The instrument should be releveled each time its location is changed.

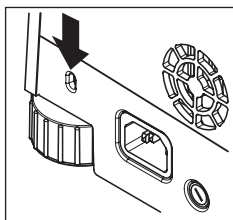

For protection against theft, your Halogen Moisture Analyzer is fitted with a socket for an anti-theft device. Together with a lockable steel cable like those used to protect portable computers against theft, the socket can be used to secure the instrument. You can obtain a suitable anti-theft cable from your METTLER TOLEDO dealer.

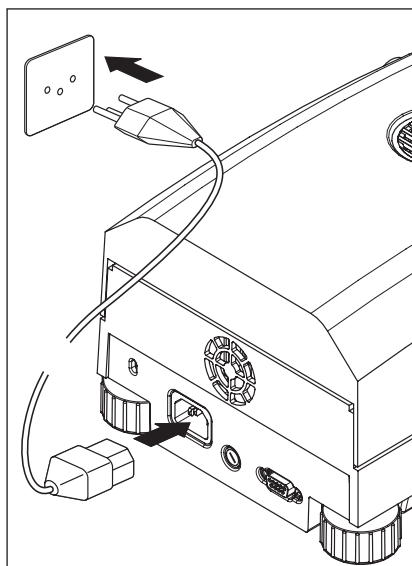

Connect the instrument to the power supply.

**Warning**

If the power cable supplied is not long enough, use only a **3-pin extension cable with equipment grounding conductor!**

**Allow your instrument to warm up for 60 minutes.** The instrument adapts itself to the ambient conditions during this time.

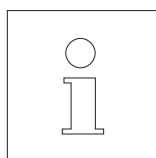

For technical reasons, the halogen heating module is designed specifically for a particular line voltage (110 VAC or 230 VAC). A heating module is installed in the factory that is matched to the particular line voltage of the country of destination. If you are not sure whether the heating module built into your instrument is suitable for your local line voltage, check the voltage printed on the glass of the circular halogen lamp before you connect the Moisture Analyzer to the power supply!



Connection to a line voltage that is too high can lead to blowing of the fuses, whereas a supply voltage that is too low will prolong the drying process.

Please note that some parts of your instrument are always live when the instrument is connected to the power supply.

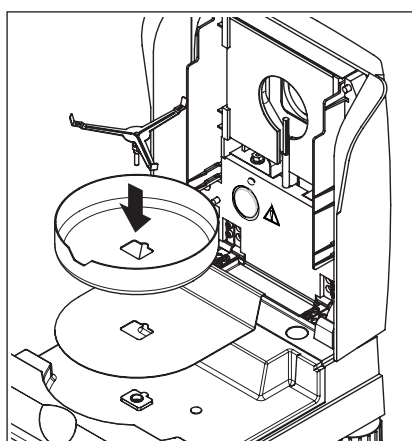

First lay the heat shield in the sample chamber. Then place the draft shield (can only be mounted in one position) and after that the sample pan support in position. Turn the sample pan support until it engages. In the engaged position the rear arm of the sample pan support lies exactly along the length of the instrument.

## 2.4 Your first measurement

After you have successfully put your new Moisture Analyzer into operation for the first time, you can immediately perform your first measurement. In doing so, you will become familiar with the instrument and the status display and at the same time perform a function check.

Please use the specimen sample supplied for your first measurement. This sample is an absorbent glass fiber filter.

For your first measurement the instrument is set to the factory settings and operates in the automatic mode, which guides you through the entire measurement procedure without you having to press a single key. You work with the predefined method "A", which specifies all of the parameters for the drying process.

Press the «On/Off» key to switch the instrument on.

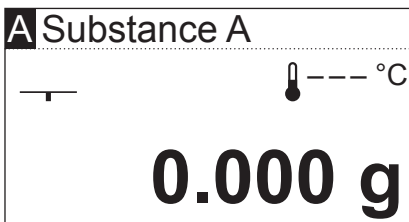

After it has been switched on, the instrument performs a self-test. Wait until the display shown opposite appears.



Your Moisture Analyzer has a graphical status display (User Guide) which you will become acquainted with in this section. The status display informs you continuously about the current status of the instrument and prompts you to execute the next operating step (shown flashing).



**Initial status** with heating module closed.

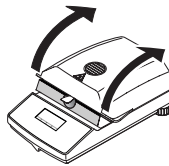

Open the heating module.



**Status: Ready for taring**

The status display flashes and prompts you to load the empty sample pan.

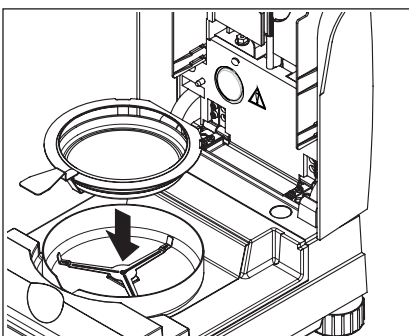

Place the empty sample pan in the sample pan handler (this is possible without tilting the sample pan if you insert this in the pan handler **from the side** directly below the round flange). Place the sample pan handler in the draft shield. Ensure that the tongue of the pan handler fits exactly in the slot of the draft shield. The sample pan must lie flat in the pan holder.

**Note:** We advise you to work with the sample pan handler at all times. The pan handler is ergonomic, safe and provides protection against possible burns due to the hot sample pan.

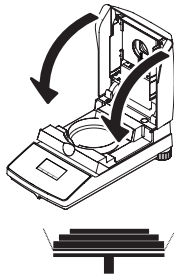

Close the heating module. This automatically sets the balance installed in the Moisture Analyzer to zero.

**Status: Ready for weighing**

After taring, the status display flashes and prompts you to place the sample in the sample pan.

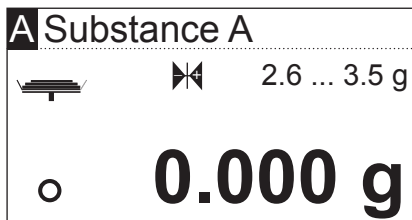

The display shows the target weight for the sample that has been specified for the corresponding method (in this example for "Substance A"). Rather than having any effect on the measurement process, this target weight just serves as a weighing-in guide. To obtain the best possible reproducibility of results, the sample quantity weighed in should lie within the target weight tolerances.

**Stability detector:** The circle symbol to the left of the weight display represents the stability detector. It is only visible while the weighing result has yet to stabilize. As soon as it disappears the weighing result is stable (see also sections 7.1 and 7.2).

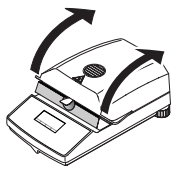

Open the heating module.

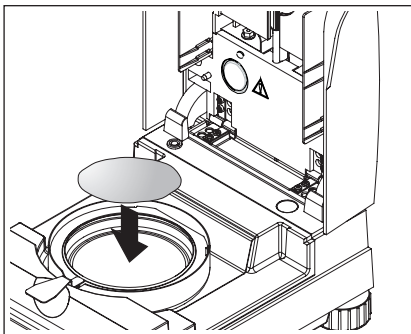

Place the provided specimen sample in the sample pan.

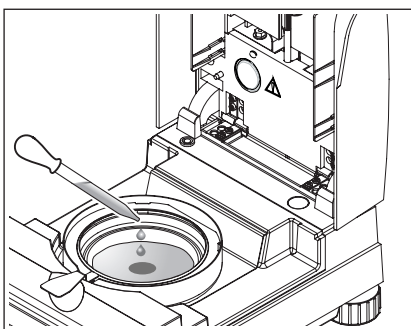

Wet the specimen sample with a few drops of water, so that the displayed weight is at least 0.5 grams (required minimum weight of sample).

**Note: The drying process cannot start until the minimum sample weight has been reached.**

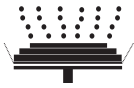

### Status: Ready for start

The status display shows that the minimum sample weight has been reached and the instrument is ready for the drying process to start.

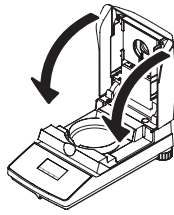

Close the heating module and the instrument then automatically begins the drying and measuring process.



### Status: Drying and measurement

You can follow the drying and measurement process on the display:

- The status display uses rising bubbles to symbolize the drying process.
- The current temperature in the heating module is displayed (above 50 °C) as well as the elapsed drying time and the current drying value.
- If there is an external printer connected to your instrument, the measurement results will be printed out continually (at intervals of 30 seconds).

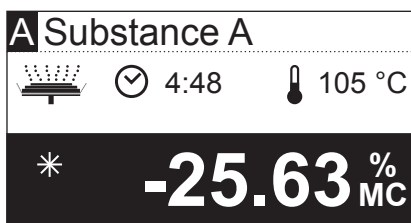

When drying is complete, an audio signal sounds and the bottom section of the display is shown in inverse (white font on dark background).

You can now read off the **moisture content** of your sample.

The star symbol to the left of the measurement result indicates that the result is a calculated result.

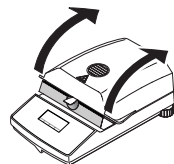

Open the heating module.

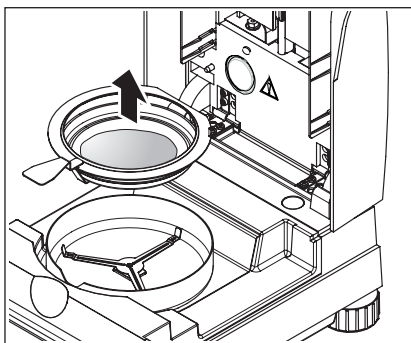

Carefully remove the sample pan handler from the sample chamber.



**Warning: As the pan and sample may still be hot, you should let these cool down before removing the pan from the handler!**

The Moisture Analyzer warns you that it is still hot: take note of the temperature display, which is continuously updated after the heating is switched off at the end of the measurement process.



The status display with the symbol opposite also shows that the instrument is still hot. This "Hot Mode" display disappears when the temperature falls below 50 °C or when you start the next cycle (in this case the status display indicates the next step).

To remove the sample pan from the handler, lift the pan slightly from below and pull it sideways out of the handler (if you no longer need the sample and the pan, you can simply tilt the handler until the pan slides out).

Press the «» key to delete the measurement result from the display. The instrument is now ready for the next measurement.

**Congratulations!**

You have just performed your first measurement with your new Moisture Analyzer. In the following section you will find important information on the operating principle of your instrument, its adjustment and optimum preparation of your samples.



# 3 How to obtain the best results

Following your first practical work with the Moisture Analyzer, in this section you will find important information on how to obtain optimum results. You will discover what parameters influence the measurement process and how you can match the instrument optimally to your particular measurement task.

## 3.1 Measurement principle of the Halogen Moisture Analyzer

Your instrument performs measurements based on the **thermogravimetric principle**, i.e. the moisture is determined from the weight loss of a sample dried by heating.

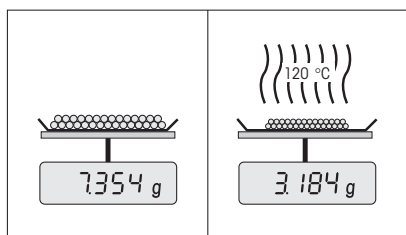

In principle, your instrument thus comprises two instruments: A precision balance and a heating module. In contrast to other thermogravimetric methods (drying oven, infrared, microwave), the Halogen Moisture Analyzer operates with a halogen heating module. This ensures fast heating of the sample and thus guarantees rapid availability of the measurement results.

Irrespective of the measurement method, the quality of the measurement results stands or falls by the **preparation of the sample** and **a correct choice of the important measurement parameters**:

- Sample size
- Drying temperature
- Switch-off mode
- Drying time



**Inappropriate setting of these parameters can cause the results to be incorrect or misleading. For this reason, check that the results for each type of sample are what might reasonably be expected.**

You will find detailed information on the relationships between these parameters in the application brochure for moisture determination, enclosed to your instrument.

In practice, however, not only the quality of the measurement results, but also the **speed of the measurement process** is important. Thanks to its drying principle (with the heat generated by a halogen radiator), the Halogen Moisture Analyzer is very fast. You can increase the speed even further through optimum setting of the instrument.

The **optimum drying temperature and the drying time** are dependent on the nature and size of the sample and on the desired accuracy of the measurement results. These can be determined only by experiment.

## 3.2 Notes on adjustment of the balance and the heating module

To obtain optimal results, when you install the Moisture Analyzer at the place where it will be used, you should use the METTLER TOLEDO adjustment set to adjust the heating module under the prevailing operating conditions (e.g. in a fume cupboard). This ensures that any differences from the factory adjustment that may result from the specific local conditions are corrected.

You should adjust your Moisture Analyzer regularly (e.g. every six months) at the place where it is used and under the prevailing operating conditions. This may also be stipulated by your quality assurance system (e.g. GLP, GMP, ISO 9001).

By adjusting the heating module you can ensure comparability with results from other instruments of the same design. This is done by using an appropriate thermometer, which is provided in the form of a temperature adjustment set with calibration certificate (see section 8.7). This adjustment set comprises a black plate with a thermometer, which allows a reproducible adjustment of the heating module.

The balance and the integral heating module in your instrument can be adjusted using the appropriate accessories (section 8.7).

A Moisture Analyzer is typically used in place of or in addition to the oven method. In an oven heat energy is transferred by the flow of air, which establishes an equilibrium between the sample temperature and the ambient temperature. This is not the case in a Moisture Analyzer. The actual sample temperature primarily depends on the specific absorption properties of the sample ("dark" samples absorb more heat), which can change during the measurement process. There can also be differences between the temperature at the surface of the sample and the temperature inside the sample. The heat output is therefore not dependent on the true sample temperature but instead is regulated by a temperature sensor underneath the halogen heating module.

For the reasons explained above, the temperature setting on the instrument will therefore deviate from the true sample temperature. By regularly adjusting the heating module, you will ensure a consistent and reproducible heat output for the entire lifetime of your instrument.

**Note:** METTLER TOLEDO offers an adjustment service – please contact your local dealer.

If you replace the heating module, you must adjust it using the temperature adjustment set, which is available as an accessory.

The procedure for adjusting the balance and heating module is described in section 5.

### 3.3 Optimum sample preparation

Preparation of the sample is decisive for the speed of the measurement process and the quality of the measurement results.

Please note the following **basic rules** for the preparation of your sample:

**The amount of sample you select should be as small as possible and only as large as necessary.**

Excessive amounts of sample require more time for drying and thus prolong the measurement process. If the amount of sample is too small, the measurement result may possibly not be representative. It is always the case that the greater the inhomogeneity of the sample, the larger the amount of sample needed to obtain a repeatable result (please see also the information in section 8.1). Experience has shown a practical sample quantity go to be 3 – 5 g. You can use the target weights specified in the predefined methods as a reference for your own samples. Please note the supplied list of the predefined methods or look them up directly on the menu of your instrument (section 4.4.2).

**Distribute the sample evenly over the sample pan.**

You thus increase the surface area of the sample and facilitate heat absorption. The base of the pan should be evenly covered.

For liquid, fat-containing, melting and highly reflecting samples, you should use the glass fiber filters HA-F1 available as accessories (see section 8.7). This also applies to samples which form a skin on their surface when heated. The glass fiber filter ensures even and rapid heat distribution and prevents the formation of a skin impervious to moisture on the sample surface.

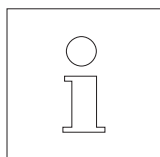

You will find further information on the moisture determination, the importance of the parameters and the preparation of the samples in the **Application Brochure** "Guide to Moisture Analysis" dealing with moisture determination (see section 8.3).

# 4 Practical application of your Moisture Analyzer

In this section we introduce you to the wide range of setting possibilities of your Moisture Analyzer and offer information and tips for optimum setting of the parameters.

## 4.1 The operating concept and methods

You already performed your first measurement in section 2. This measurement was carried out using the factory settings. However, your instrument offers a number of setting possibilities to match the measurement process to your specific requirements.

The operating concept of your Moisture Analyzer is based on **methods**. A method contains all of the parameters for a drying process. These include:

- The name of the method
- The target weight of the sample
- The drying program
- The drying temperature
- The switch-off criterion
- The type of display
- A free factor (optional)

Each of the two **keys «A» and «B»** on the keypad of your dryer can be allocated to one method. Pressing the required key loads all of the parameters of the corresponding method and drying is performed with the matching settings. The active method ("A" or "B") and its name are shown on the top line of the display.

Your Moisture Analyzer contains a **database** in which over 100 methods have already been predefined for different products. You can use one of the predefined methods directly, or adapt its parameters to your own requirements. You make these settings on the **menu** that we will introduce you to in the following sections.

## 4.2 The menu

You can choose methods from the menu and change their parameters. The menu also contains other options for carrying out adjustments and for the basic settings of your Moisture Analyzer. You will familiarize yourself with these functions and settings in section 5. All menu settings are preserved even in the event of a power failure.

Method A			
<b>Method B</b>			
SmartCal			
⤴	⤵	Sel.	Exit

Press the «Menu» key to display the menu.

The menu options are shown in the top section of the display. The four fields at the bottom of the display contain the names of the "Softkeys", i.e. the keys whose function depends on the position on the menu. The four "Softkeys" are immediately underneath the display.

The option chosen from the menu is shown in inverse (white font on dark background). You can use the two arrow keys to select a different menu option by scrolling. If one of these two keys is no longer visible, you have reached the top or bottom of the list.

When you want to exit the menu, choose «Exit» (you can also exit the menu at any time by pressing the «⏪» key).

## 4.3 Choosing and allocating methods from database

One method is allocated to each key «A» and «B» on the keypad. You can therefore quickly switch between two methods as part of the daily routine. On the menu you can choose from a database the methods that are to be allocated to the two keys.



<b>Method A</b>			
Method B			
	⤵	Sel.	Exit

Press the «Menu» key to display the menu.

In the following example we assume you want to allocate a method to the «A» key. Ensure that "Method A" is highlighted, then press «Sel.» to display the method database.

1600.02 Sodium tartrat			
<b>0000.0A Substance A</b>			
0000.0B Substance B			
⤴	⤵	Edit	⏪

The **database** contains over 100 predefined methods, each of whose sets of parameters are designed to suit a particular product or group of products. The first four digits of the number of each method are based on the "NACE" code. "NACE" is a European Union system for classifying industrial sectors and product groups. The two digits after the dot are a consecutive numbering system. Further information on the "NACE code" and the preset parameters of the individual methods is to be found in the separate brochure supplied with your Moisture Analyzer. The two methods "Substance A" and "Substance B" contain standard parameters (basic settings).

1510.01 Egg yolk pow...			
<b>1510.02 Poultry meat</b>			
1510.03 Beef meat			
		Edit	

Use the arrow keys to choose the required method and confirm with «←».

Method A		
Method B		
	Sel.	Exit

The next-higher menu level will then be displayed again. Press «Exit» to quit the menu.

Save changes?	
No	Yes

You are now asked whether you want to save the change. Press «Yes» to save it. Choose «No» if you want to exit the menu without saving (in this case **all** of the changes you have made on the menu will be discarded).

<b>A</b> Poultry meat		--- °C
<b>0.000 g</b>		

If you have saved the new method allocation, the chosen method will then be made available when you press the «A» key.

If none of the predefined methods meet your requirements, you can define your own methods as described in the next Section.

```

---METHOD PARAMETERS---
METTLER TOLEDO    HB43-S
SNR                123456789
SW                 2.00

-----METHOD A-----
Name              Poultry meat
Method ID         1510.02
Target weight     3.000 g
Drying program    STD
Temperature       160°C
Switch-off mode   3
Display mode      %MC
Free factor       Off



```

If a printer is connected to your Moisture Analyzer, you can press the «» key to print out all of the parameters of the two methods allocated to the «A» and «B» keys. Notes on the parameters are to be found in the next section.

## 4.4 Developing own methods and defining parameters



If none of the existing methods in the database meets your requirements, you can develop your own and allocate them to the «A» or «B» key. You can achieve this by choosing one of the existing methods and changing its parameters.

**Important: Some methods are only saved until you allocate a new method to the corresponding key!**

Method A		
Method B		
SmartCal		
 	Sel.	Exit

Press the «Menu» key to display the menu.



Choose the key to which the new method is to be allocated (in the opposite example the «B» key). Then press «Sel.» to display the method database.

1530.10 Tomato powd...		
1530.11 Tomato juice		
1530.12 Onion powder		
 	Edit	

Use the arrow keys to choose the method that is to form the basis of the new method. In order to minimize the number of changes you have to make, we recommend you choose a method whose parameters largely correspond to those of the new method to be developed.



Press «Edit» to display the parameters of the method.

**Note:** All of the existing predefined methods have a number based on the "NACE code". When you change the parameters of such a method, an (un-numbered) copy of it is automatically created, with the original remaining unchanged. Copies can be changed as required.

Name Tomato juice			
Target weight			
		Edit	

The display shows a list of all of the parameters of the method: Name, target weight, drying program, drying temperature, switch-off criterion, type of display and free factor. You will familiarize yourself with these parameters in the following sections.

### 4.4.1 Specifying name of method

Tomato juice			
abc...	A...		
			

Use the arrow key to choose the parameter "Name" and press «Edit». There are two keys available for changing the name of the method:

- 1 Choose this option if you want to change the existing name.
- 2 Deletes the existing name. Choose this option if you want to enter a completely new name.

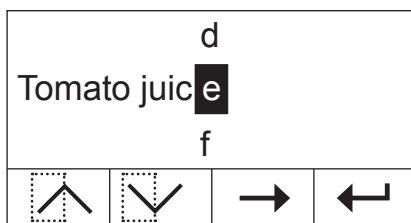

### Changing existing name

The cursor is positioned on the last character of the existing name and the «←→» key remains visible for a few seconds. If you want to delete part of the existing name, press this key immediately and delete the required characters. The «←→» key disappears after a few seconds and is replaced with the «→» key. You can now enter the first new character: Scroll the list of characters upwards or downwards until the required character is displayed and press the «→» key to move the cursor to the next position. The name of the method can be up to 20 characters long.

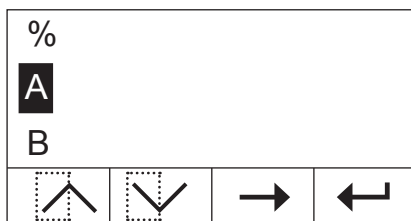

### Entering new name

The existing name is deleted and the cursor is on the first character of the new name. Scroll the list of characters upwards or downwards until the required first character of the new name is displayed and press the «→» key to move the cursor to the next position. Choose the second character from the list of characters. The name of the method can be up to 20 characters long.

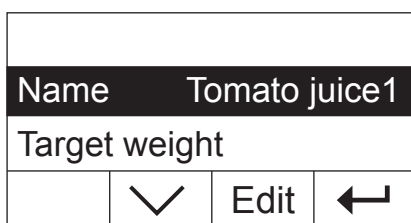

As soon as you have entered all of the name of the method, press «←». The next-higher menu level will then be displayed again and you can recheck the name. In the opposite example the number "1" has been appended to the existing name.

## 4.4.2 Specifying target weight of sample

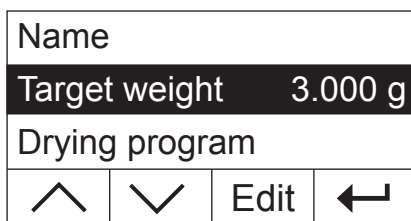

Use the arrow keys to choose the parameter "Target weight" and press «Edit».

**Note:** The target weight is just a guide to make it easier for you to weigh in the correct amount of the sample. Adherence to the target weight is not monitored. During weighing in, the target weight is displayed with a tolerance of 15% (e.g. "2.6 ... 3.5 g"). This tolerance is calculated by the Moisture Analyzer and cannot be changed by the user.



The current target weight flashes. You can use the «+» and «-» keys to change the weight in 0.5 g increments. The minimum value is 0.5 g, the maximum 54.0 g.

Confirm the new target weight with «←». the next-higher menu level will then be displayed again and you can recheck the new target weight.



### 4.4.3 Selecting the drying program

Target weight			
Drying program		Rapid	
Temperature			
^	v	Edit	←

Use the arrow keys to choose the parameter "Drying program" and press «Edit».

STD			
Drying program		Rapid	
LP16			
^	v		←

Three different drying programs enable you to match the drying characteristic perfectly to the sample used.

**Standard drying** ("STD"): This drying program is suitable for most samples. The sample is heated to the drying temperature (set temperature) and held constant at this temperature.

**Rapid drying:** This program is primarily suitable for samples with a moisture content over 30%. Following the start, the selected temperature is exceeded by 40% for 3 minutes to compensate the cooling due to vaporization and accelerate the drying process. The drying temperature is then lowered to the set value and maintained.

**LP16:** This drying program corresponds to that of the earlier dryers, LP16 and LJ16. The chosen set temperature (see next section) corresponds to the final temperature of these models. If you choose this program, you cannot define any switch-off criterion (section 4.4.6), the switch-off characteristic corresponds to that of the LP16/LJ16. This program is primarily suitable for users of the earlier dryers who want to achieve a drying characteristic as similar as possible with the HB43-S.

Confirm the chosen drying program with «←». The next-higher menu level will then be displayed again and you can recheck the drying program.

### 4.4.4 Setting the drying temperature

Drying program			
Temperature		130 °C	
Switch-off mode			
^	v	Edit	←

Use the arrow keys to choose the parameter "Temperature" and press «Edit».

Temperature		131 °C	
-	+		←

The current drying temperature flashes. You can use the «+» and «-» keys to change the temperature in the range from 50 to 200 °C in 1 °C increments.

**Note:** If you choose a drying temperature of over 160 °C, for reasons of backward compatibility with methods already developed for the Moisture Analyzer HB43, you can choose timed temperature reduction.

Confirm the new drying temperature with «←». The next-higher menu level will then be displayed again and you can recheck the new drying temperature.

#### 4.4.4.1 Setting the drying temperature directly

If method "A" or method "B" is active, the drying temperature can be set directly using the «Drying temperature» key.



Press the «Drying temperature» key.

Temperature 105 °C			
-	+		←

You can use the «+» and «-» keys to change the temperature in the range from 50 to 200 °C in 1 °C increments.

Temperature 120 °C			
-	+		←

Confirm the new drying temperature with «←».

Save changes?			!
	No	Yes	

Press «Yes» to save the changes or «No» to exit the menu without saving. **Note:** If you do not want to save the changes, instead of the «No» you can also press the «⏠» key.

#### 4.4.5 Temperature reduction

Temperature			
Temp. reduction		On	
Switch-off mode			
^	v	Edit	←

**This menu option is only available if you have chosen a drying temperature of over 160 °C.**

Use the arrow keys to choose the parameter "Temp. reduction" and press «Edit».

Temp. reduction			
		On	
		Off	
	v		←

The following two settings are available.

**On:** This setting allows full backward compatibility with methods already developed for the HB43 with temperatures of over 160 °C. For temperatures over 160 °C temperature reduction occurs. The higher the temperature the less time it takes for the temperature to drop. The temperature is lowered continuously until after 1 hour it has reached 160 °C. The temperature of 160 °C is then maintained until the end of the measuring time.

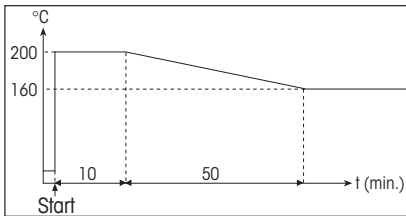

The diagram opposite shows the envelope of the temperature reduction.  
**Off:** The instrument heats to the chosen drying temperature (of over 160 °C) and maintains this temperature until the end of the measuring time.  
 Confirm the chosen setting with «←». The next-higher menu level will then be displayed again.

When working with temperatures over 180 °C we recommend that you always wait 2 - 3 minutes with open instrument lid between individual measurements, in order to ensure good reproducibility of the readings and avoid overheating of the instrument.

To protect the instrument from overheating, it has an **additional protective device:** A temperature switch independent of the normal black temperature sensor over the sample is triggered when it detects exceptionally high temperatures. This situation could arise, for example, if the sample begins to burn or the heating module adjustment is defective. If this happens, the heating module is tripped out by a mechanical switch, and the instrument cannot be restarted. Reset the overload switch (see section 7.2).

#### 4.4.6 Selecting the switch-off criterion

Temp. reduction			
Switch-off mode			3
Display mode			
∧	∨	Edit	←

**This menu option is only available if you have chosen "LP16" as drying program** (section 4.4.3).

Use the arrow keys to choose the parameter "Switch-off mode" and press «Edit».

A switch-off criterion defines when the instrument should end the drying. Switch-off criteria save you having to keep checking your watch and stopping the drying manually. The following settings can be selected for the switch-off criterion:

- "Weight loss per unit of time" (5 settings)
- "Free switch-off"
- "Manual switch-off"
- "Timed switch-off"

			2
Switch-off mode			3
			4
∧	∨		←

##### Weight loss per unit of time

This switch-off criterion is based on a weight loss per unit of time. As soon as the mean weight loss is less than a preset value during a specified time, the instrument considers drying to be complete and automatically discontinues the measurement process. During the drying, the time display shows you how long the measurement process has been in progress. The switch-off criterion is inactive during the first 30 sec. You will find additional information in section 8.4. The following 5 settings are available:

- 1** This setting is suitable for samples which dry very quickly (surface moisture) or for (relatively inaccurate) fast measurements to determine a trend.
- 2** This setting is suitable for quick drying samples.
- 3** This setting is suitable for most types of samples.

- 4 This setting is suitable for samples which dry moderately quickly.
- 5 This setting is suitable for samples which dry very slowly (trapped moisture, skin formation).

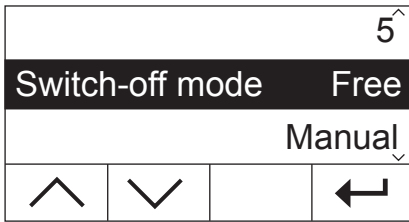

**Free switch-off criterion**

If none of the five available "Weight loss per unit of time" switch-off criteria is suitable for your application, the Moisture Analyzer allows you to define a free switch-off criterion (1 mg/20 s to 1 mg/180 s). The free switch-off criterion is also based on the principle of weight loss per unit of time. As soon as this drops below the preset value, the measurement is automatically ended.

If you have chosen this setting, an additional menu option for setting the time interval becomes available (see section 4.4.7).

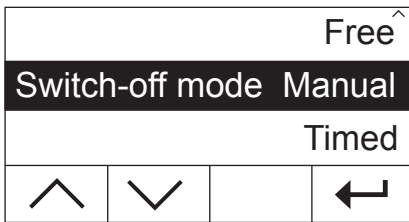

**Manual switch-off**

With this switch-off criterion the measurement process continues until you stop it with the «Stop» or «Home» key.

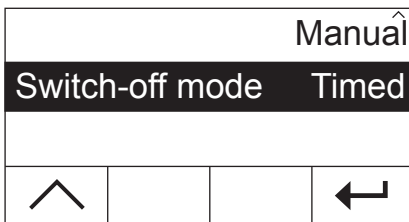

**Timed switch-off**

With this switch-off criterion the measurement lasts until the preset drying time has elapsed (the time display provides you with continuous information on the drying time).

If you have chosen this setting, an additional menu option for setting the drying time becomes available (see section 4.4.8).

Confirm the chosen switch-off criterion with «←». If you have chosen the free switch-off criterion or the timed switch-off, you can now specify the time interval or the drying time as described in the following sections.

#### 4.4.7 Setting time interval for free switch-off criterion

Switch-off mode
<b>Time interval</b> 20 s
Display mode
^   v   Edit   ←

**This menu option is only available if you have chosen the free switch-off criterion** (section 4.4.6).

Use the arrow keys to choose the parameter "Time interval" and press «Edit».

<b>Time interval</b> 75 s
-   +     ←

The current time interval to which the weight loss of 1 mg relates flashes. You can use the «+» and «-» keys to change the time interval within the range from 20 to 180 seconds in 1 second increments (**Factory setting:** 20 seconds).

Confirm the new time interval with «←». The next-higher menu level will then be displayed again and you can recheck the time interval.

#### 4.4.8 Setting drying time for timed switch-off

Switch-off mode
<b>Time</b> 10 min
Display mode
^   v   Edit   ←

**This menu option is only available if you have chosen the timed switch-off** (section 4.4.6) as switch-off criterion.

Use the arrow keys to choose the parameter "Time" and press «Edit».

<b>Time</b> 15 min
-   +     ←

The current drying time flashes. You can use the «+» and «-» keys to change the drying time within the range from 1 to 480 minutes in 1 minute increments.

Confirm the new drying time with «←». The next-higher menu level will then be displayed again and you can recheck the drying time.

#### 4.4.9 Selecting the display mode

Switch-off mode
<b>Display mode</b> %MC
Free factor
^   v   Edit   ←

Use the arrow keys to choose the parameter "Display mode" and press «Edit».

<b>Display mode</b> %MC
%DC
^   v     ←

Five different types of result display are available to you. The particular one chosen also determines which values are shown on the records printed out.

You will find a description of all five types of display below.

## g: Weight in grams

The weight of the sample is displayed (and printed out) in grams. During the drying the current weight is continuously displayed in grams.

### %MC: Moisture content

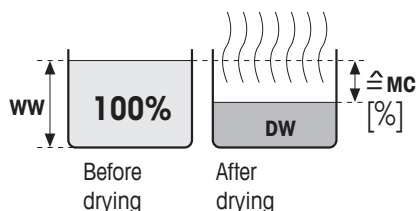

The moisture content of the sample is displayed (and printed out) as a percentage of the wet weight (= WW = initial weight = 100%). This is the factory setting. When the results are printed out, the moisture content is designated "%MC" (**M**oisture **C**ontent) (e.g. -11.35 %MC) and shown as a negative value. During the drying the current measured value is continuously displayed in percent.

$$\text{MC [0...-100\%]} = - \frac{\text{Wet weight } \mathbf{WW} - \text{Dry weight } \mathbf{DW}}{\text{Wet weight } \mathbf{WW}} * 100\%^*$$

### %DC: Dry content

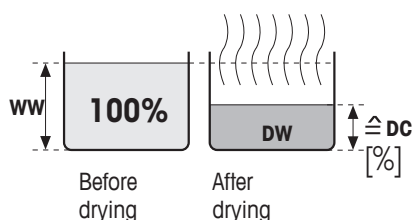

The dry content of the sample is displayed (and printed out) as a percentage of the wet weight (= WW = initial weight = 100%). When the results are printed out, the dry content is designated "%DC" (**D**ry **C**ontent) (e.g. 88.65 %DC). During the drying the current measured value is continuously displayed in percent.

$$\text{DC [100...0\%]} = \frac{\text{Dry weight } \mathbf{DW}}{\text{Wet weight } \mathbf{WW}} * 100\%$$

### %AM: ATRO moisture content

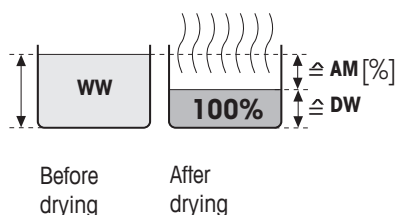

The moisture content of the sample is displayed (and printed out) as a percentage of the dry weight (= DW = final weight = 100%). When the results are printed out, the ATRO moisture content is designated "%AM" (**A**TRO **M**oisture **C**ontent) (e.g. -255.33 %AM) and shown as a negative value. During the drying the current measured value is continuously displayed in percent.

$$\text{AM [0...-1000\%]} = - \frac{\text{Wet weight } \mathbf{WW} - \text{Dry weight } \mathbf{DW}}{\text{Dry weight } \mathbf{DW}} * 100\%$$

### %AD: ATRO dry content (Wet weight)

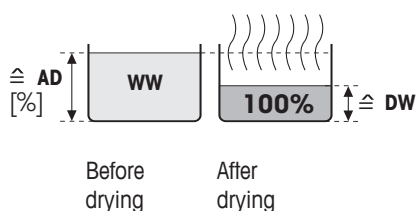

The wet weight of the sample is displayed (and printed out) as a percentage of the dry weight (= DW = final weight = 100%). When the results are printed out, the ATRO dry content is designated "%AD" (**A**TRO **D**ry **C**ontent) (e.g. 312.56 %AD). During the drying the current measured value is continuously displayed in percent.

$$\text{AD [100...1000\%]} = \frac{\text{Wet weight } \mathbf{WW}}{\text{Dry weight } \mathbf{DW}} * 100\%$$

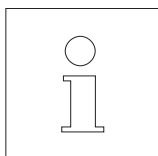

### Comment on the ATRO display mode

If the current measured value in the ATRO display mode is greater or less than the predefined limit value (i.e. greater than 999.99 %AD or less than -999.99 %AM), a warning beep sounds and the instrument automatically switches the display mode (from %AM to %MC and from %AD to %DC). A display in the ATRO mode is no longer possible in this case, even if you have started your drying operation in the %MC, %DC or "g" (grams) display mode.

#### 4.4.10 Activating free factor

Display mode			
Free factor			Off
^		Edit	←

Use the arrow keys to choose the parameter "Free factor" and press «Edit». The free factor is deactivated in the factory.

The free factor allows conversion of the final result of a drying process. It can be used to compensate for systematic deviations from a reference result for example. Corrected final results only appear on the records printed out (not on the display) and are listed separately and without units.

			Off
Free factor			On
^			←

Switch the free factor on if you want to correct the final result.

Confirm your setting with «←». The next-higher menu level will then be displayed again, making available two additional menu options for defining the factor (see sections 4.4.11 and 4.4.12).

#### 4.4.11 Specifying free factor

Free factor			
Factor			1.000
Output format			
^	v	Edit	←

**This menu option is only available if you have activated the free factor** (section 4.4.10).

The free factor is set to 1.000 in the factory. Press «Edit» to change this setting.

			1.048
Factor			
-	+		←

The current factor flashes. You can use the «+» and «-» keys to change the factor within the range from -10.000 to + 10.000 in increments of 0.001.

Confirm the new factor with «←». The next-higher menu level will then be displayed again and you can recheck the factor.

#### 4.4.12 Choosing number of decimal places

Factor			
Output format		X.XX	
^		Edit	←

This menu option is only available if you have activated the free factor (section 4.4.10).

The final result that has been calculated and corrected by the free factor is displayed to 2 decimal places (factory setting). Press «Edit» to change this setting.

		X.X <sup>^</sup>	
Output format		X.XX	
		X.XXX	
^	∨		←

The current setting flashes. Use the arrow keys to choose whether you want to display the final result without ("X"), with one ("X.X"), two ("X.XX") or three ("X.XXX") decimal places.

Confirm the new number of decimal places with «←». The next-higher menu level will then be displayed again and you can recheck the setting.



**When choosing the output format, take account of the fact that the significance of the decimal places depends on the sample quantity weighed in and the chosen "Free factor"!**

#### 4.4.13 Saving new method and exiting menu

Save changes?			
		No	Yes

After you have defined all of the parameters of the new method, press the «←» key repeatedly until you are asked whether you want to save the changes (each keystroke accesses the next-higher menu level). **Note:** Instead of the «←» key you can also press the «A» key from any position on the menu. This exits the menu immediately. You will also be asked in this case whether you want to save the changes.

Press «Yes» to save the changes or «No» to exit the menu without saving.

**Note:** If you do not want to save the changes, instead of the «No» you can also press the «↑» key.

If you have saved the new method, it will be available to you when you press the corresponding key («A» or «B»).

**Important: Some methods are only saved until you allocate a new method to the corresponding key!**



#### 4.4.14 Printing out records of methods

```
---METHOD PARAMETERS---  
METTLER TOLEDO    HB43-S  
SNR                123456789  
SW                 2.00  
  
-----METHOD B-----  
Name               Tomato juice  
                   modified  
Target weight     3.000 g  
Drying program    Rapid  
Temperature        130 °C  
Switch-off mode   Free  
                  1 mg / 38 s  
Display mode      %MC  
Free factor       On  
Factor            1.516  
Output format     X.XXX  
  
---26.10.2011---15:09---
```

If from any position on the method definition menu you press the «» key, the settings of the method are printed out. If you have made changes that have not yet been saved, you are asked whether you want to save them (the last set of parameters saved are always printed out). The Moisture Analyzer then reverts to the normal operating state.

**Note:** Even outside the menu you can print out a record of the methods with the «» key, provided there is no measurement being carried out.

The sample record opposite is for a method defined by the user.

## 4.5 Performing a measurement

You are now familiar with all the method parameters of your Moisture Analyzer and have defined your own methods for your samples. The instrument is now ready for the determination of the moisture content of your own samples. In this section you will learn how to perform measurements, print out the measurement results and stop the measurement process.

Switch the instrument on with «On/Off» key.

Use the «**A**» or «**B**» key to choose the method you want to use to dry your sample.



The status display (User Guide) symbolizes the initial status of the instrument when the heating module is closed.

The instrument is set in the factory to operate in the automatic mode and you can perform the entire drying process without pressing any keys. You will find information on the manual mode in section 5.6.8.

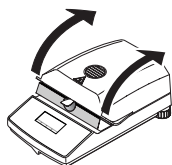

Open the heating module.



The status display (User Guide) now prompts you to load the empty sample pan.

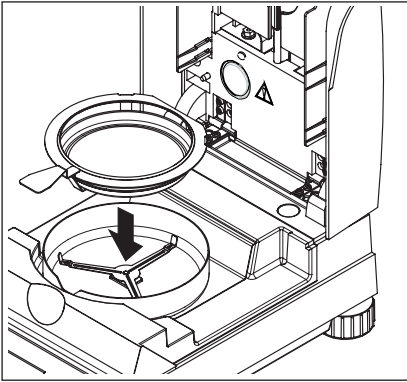

Position the empty sample pan in the sample pan handler. Place the sample pan handler in the draft shield. Ensure that the tongue of the sample pan handler lies exactly in the slot of the draft shield. The pan must lie flat in the pan holder.

**Note:** We advise you to work with the sample pan handler at all times. The pan handler is ergonomic, safe and provides protection against burns due to the hot sample pan.

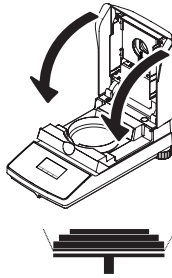

Close the heating module. The built-in balance is then automatically set to zero.



Following taring, the status display prompts you to add the sample to the sample pan.

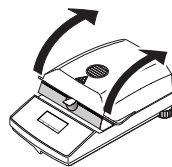

Open the heating module.

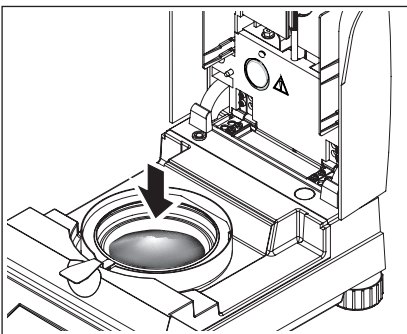

Add the sample to the sample pan. Please ensure that the sample is distributed evenly to obtain good analysis results.

The minimum sample weight required is 0.5 g. Please take account of the displayed target weight for your sample when weighing in. To obtain the best possible reproducibility of results, the sample quantity weighed in should lie within the target weight tolerances.



The status display indicates that you can now start the drying process.

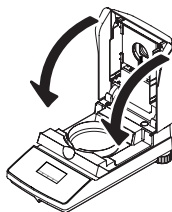

As soon as the sample has been put in, close the heating module and the instrument will automatically start the drying and measuring process.



You can follow the measurement process on the display: The status display uses ascending bubbles to symbolize the drying process with the following values being continuously updated and displayed:

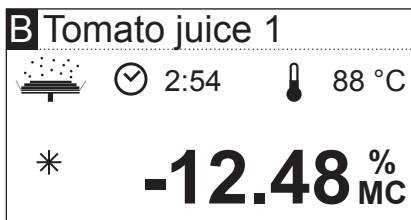

- current temperature in the heating module
- elapsed time since the start of the measurement process
- current result in the chosen display mode.

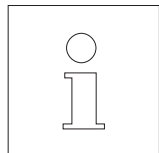

Your instrument is set in the factory so that the current intermediate result is printed out every 30 seconds if a printer is connected. If you want to, you can switch off printing out of records or set manual printing (using the «») key . You will find information on the settings for the printer in section 5.6. You will find an explanation of the measurement record in the next section.

As soon as the switch-off criterion stipulated when defining the method is met (or the selected drying time has elapsed), a beep is given.

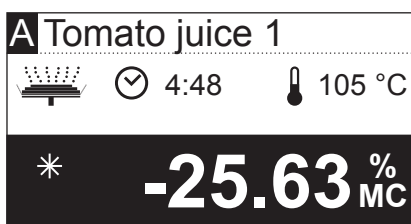

You can now read the measurement off the display. You will find information on the interpretation of the measurement results in section 8.1. The result and time display remain at their final values, whereas the temperature continues to be updated.

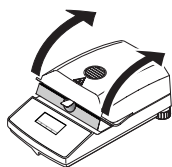

Open the heating module.

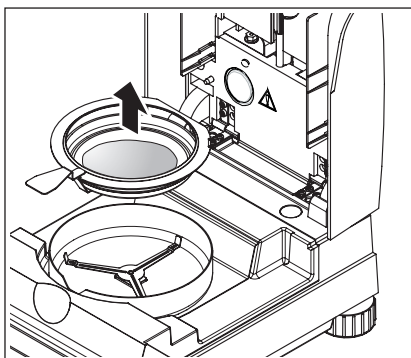

Carefully remove the sample pan handler from the sample chamber.



**Warning: Pan and sample may still be hot! Allow them to cool before you remove the pan from the handler!**

Press the «» key to delete the final result and the time display (alternatively, you can also use the «Stop» or «->0/T<-» keys).

If you do not wish to perform another measurement, switch the instrument off with the «On/Off» key and close the drying unit.

### **Stopping measurement**

You can manually **stop** the measurement process **prematurely** at any time by pressing the «Stop» key. After a measuring time of at least 30 seconds, the result will be displayed from the time when the process is stopped.

If you stop the measurement process sooner, or terminate it with the «» key or by opening the heating module, the measurement result will not be displayed, instead a message to the effect that the measurement has been stopped will appear. This message must be confirmed by pressing «OK».

## 4.6 Information on the measurement record

If your instrument is connected to a printer, and if the printer has been activated from the menu, the intermediate values will be printed out at the preselected intervals and the final result recorded on completion of the measurement. The following illustration shows a **sample record**. The record contains the following data:

```

A -MOISTURE DETERMINATION-
B METTLER TOLEDO      HB43-S
C SNR                  12345678
D SW                   2.00
E Name                 Tomato juice 1
F                      modified
G Target weight       3.000 g
H Drying program      STD
I Temperature         130 °C
J Switch-off mode     3
K Display mode        %MC
L Free factor         On
  Factor              1.516
  Output format       X.XXX

M Initial wt.        0.645 g

N   0:30 min         -6.05 %MC
   1:00 min         -14.26 %MC
   1:30 min         -22.02 %MC
   2:00 min         -29.30 %MC
   2:30 min         -36.43 %MC
   3:00 min         -43.10 %MC
   3:30 min         -46.82 %MC
   4:00 min         -47.13 %MC

O Total time         4:09 min
P Dry weight         0.341 g
Q Result            -47.13 %MC
R Adj. value        -71.449

S Sample ID: .....
T Comment: .....
U Signature: .....
V ---26.10.2011---16:40---
```

- A** Record title
  - B** Manufacturer and designation of the instrument
  - C** Serial number of the instrument
  - D** Version number of the software
  - E** Chosen drying method
  - F** Indicates a method developed by the user
  - G** Target weight of the sample (weighing-in guide)
  - H** Selected drying program
  - I** Drying temperature (set temperature)
  - J** Selected switch-off criterion (or set drying time)
  - K** Selected display mode
  - L** Free factor activated (factor and output format specified)
  - M** Sample weight at start of drying
  - N** Measured value at each print interval (the number of recorded measured values depends on the selected print interval and the measurement time)
  - O** Total time of drying
  - P** Indication of dry weight (final weight)
  - Q** Final result in the selected display mode
  - R** Converted final result (only if the free factor has been activated)
  - S** Line for entry of the sample ID
  - T** Line for entry for comments
  - U** Line for signature
  - V** Date and time at the end of the measurement
- Note:** You will find information on the units of the results (%MC, %DC, %AM and %AD) in section 4.4.8.

```

>>>>>>>MANUAL<<<<<<<<<
---26.10.2011---18:09---
```

```

>>>>>>>>>ABORT<<<<<<<<<
---26.10.2011---17:58---
```

**Special events** are recorded on the measurement record as follows:

You have stopped a measuring cycle prematurely after a measuring time of at least 30 seconds manually with the «Stop» key. The final result is printed out, but the record is specially labeled to indicate that measurement was aborted.

You have stopped a current measurement cycle after less than 30 seconds with the «Stop» key or in some other way (using the «⏏» key or opening the heating module). No final result is printed out and the record is labeled as shown opposite.

# 5 Basic settings of the instrument

In this section you will learn how to define the settings your instrument uses for operation. You will also learn how to adjust the built-in balance and the heating module. These settings and functions are available on the menu with which you have already become familiar in section 4.

## 5.1 Menu overview

Press the «Menu» key to call up the menu. The following menu options are available:

Method A			
Method B			
	∨	Sel.	Exit

You have already become familiar with the two menu options for allocating methods to the «A» and «B» keys in section 4.

Press the arrow key to scroll the list of menu options.

SmartCal			
Weight adjust. #1			
Temperature adj.			
∧	∨	Start	Exit

With the two menu options "Weight adjust." and "Temperature adj." you can adjust the integrated balance and the heating module (sections 5.3 and 5.4).

**Note:** The number shows the next adjustment. In the opposite example the integrated balance had not yet been adjusted.

Temperature adj.			
Language English			
System settings			
∧	∨	Edit	Exit

The menu option "Language" allows you to specify the language in which the Moisture Analyzer is to communicate with you (section 5.5).

The "System settings" contain basic settings for Moisture Analyzer operation (for example, date and time, pressure interval, etc.). You will find further information in section 5.6.

System settings			
Interface			
Factory reset			
∧	∨	Sel.	Exit

The menu option "Interface" allows you to specify the communication parameters of the built-in RS232C interface (section 5.7).

The option "Factory reset" resets most of the menu settings to the factory settings (section 5.8).

```

----LIST OF SETTINGS----
METTLER TOLEDO    HB43-S
SNR              123456789
SW              2.00
Language         English
System settings
Time format      24:MM
Date format      DD.MM.YY
Contrast         50 %
Brightness       90 %
Menu protection  Off
Start mode       Auto
Printout         On
Print interval   30 s
Interface
Baudrate         9600
Bit / Parity     8/No
Handshake        Xon/Xoff

---26.10.2011---15:27---

```

If you have chosen a menu option, by pressing the «» key you can print out a corresponding record of the current settings. If you have made changes that have not yet been saved, you are asked whether you want to save them (the last set of parameters saved are always printed out). The Moisture Analyzer then reverts to the normal operating state.

The opposite example shows a sample record with the language, system and interface settings.

The following sections will acquaint you with the individual menu items. The order corresponds exactly to that in the menu.

## 5.2 Testing the moisture analyzer with SmartCal

Proper operation of the halogen moisture analyzer can be quickly verified with a SmartCal test. SmartCal is a granular test material with a defined moisture value after a specified time at a defined drying temperature. SmartCal is available for four test temperatures. There are control limits for each test temperature. If the measured and normalized moisture value is within the control limits, the instrument has passed the functional test. If the value is outside the control limits, there may be a problem with the instrument or the test conditions may not have been met. Additional information on using SmartCal is available at [www.mt.com/smartcal](http://www.mt.com/smartcal).

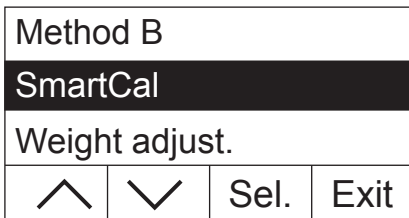

Choose the menu option "SmartCal" and press «Sel.».

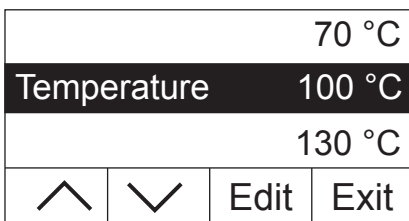

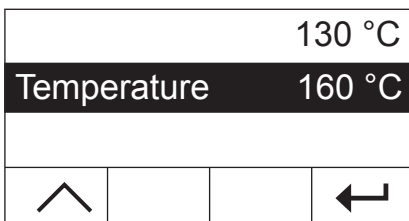

Press «Edit».  
A list with the four test temperatures appears on the display.



Use the arrow keys to select the desired test temperature, then press «».

Place empty pan Close heating unit			



You will be prompted to place the sample pan in the instrument. Open the heating module. Position the empty sample pan in the sample pan handler. Close the heating module. The built-in balance is then automatically set to zero.

SmartCal	
	 --- °C
■ ■ ■ ■ ■	



The instrument measures the tare weight.

Distribute SmartCal Close heating unit			

Open the heating module. Distribute the sample evenly in the sample pan. After you close the heating module, the instrument automatically starts the drying process.

SmartCal	
	 0:25  87 °C
*	<b>3.77</b> %MC

The instrument records the starting weight and starts drying.

SmartCal	
	 10:00  160 °C
*	<b>-10.95</b> %MC

After drying is finished, you can read the measured moisture content of the test material (not normalized). Confirm the result with «OK».

Result -10.95 %MC (not normalized)			
			OK

Record ambient cond. °C and %rH			
			OK

Enter the displayed moisture reading in the measurement record. Also enter the room temperature and relative humidity in the measurement record.



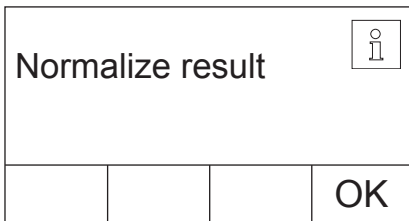

Using the ambient conditions, normalize the displayed moisture reading and check the normalized value against the control limits. The limit values can be found in the SmartCal Short Operating Instructions (order number 30005792) or at [www.mt.com/smartcal](http://www.mt.com/smartcal).

End the test with «OK». The moisture analyzer is now ready for other measurements.

```

A  -MOISTURE DETERMINATION-
B  METTLER TOLEDO      HB43-S
C  SNR                  12345678
D  SW                   2.00
E  Name                 SmartCal
F  Target weight       8.500 g
G  Drying program      STD
H  Temperature         160 °C
I  Switch-off mode     Timed
K  Time                10 min
L  Display mode        %MC
M  Free factor         Off

N  Initial wt.         8.614 g
O  Total time          10:00 min
P  Dry weight.         7.670 g
Q  Result (not norm.)
                               -10.95 %MC

R  Sample ID: .....

Environment conditions:
S  Temperature.....°C
T  Rel. humidity.....%rH
U  Norm. result.....%MCN

V  Signature: .....

W  ---26.10.2011---10:32---
```

If a printer is connected to your instrument and it is switched on (see section 5.6.9), a test record is printed out automatically after completion of the test. The following data is included in this record:

- A** Record title
- B** Manufacturer and designation of the instrument
- C** Serial number of the instrument
- D** Version number of the software
- E** Chosen drying method
- F** Target weight of the sample (weighing-in guide)
- G** Selected drying program
- H** Test temperature (set temperature)
- I** Selected switch-off criterion
- K** Duration of the test measurement
- L** Selected display mode
- M** Free factor deactivated
- N** Sample weight at start of drying
- O** Total time of drying
- P** Indication of dry weight (final weight)
- Q** Final result
- R** Line for entry of the sample ID
- S** Line for entry of the ambient temperature
- T** Line for entry of the relative humidity
- U** Line for entry of the normalized moisture reading
- V** Line for signature
- W** Date and time at the end of the measurement

### 5.3 Adjusting the balance

With this menu item you can adjust the balance of your instrument. Consult section 3.2 to learn when an adjustment is necessary. Before selecting the adjustment function, ensure that the sample pan is in position. Following a drying cycle, you should wait at least 30 minutes before undertaking an adjustment.

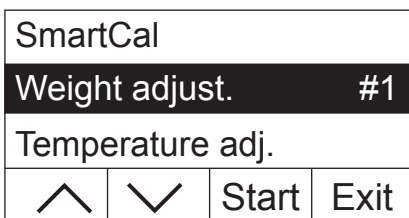

Choose the menu option "Weight adjust." and press «Start».

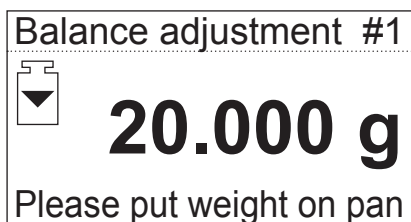

You are prompted to put the requested adjustment weight of 20 grams on the pan (the adjustment weight is available as accessories, see section 8.7). Place the requested adjustment weight in the middle of the sample pan.

**Note:** You can use the «⏏» key to stop weight adjustment at any time.

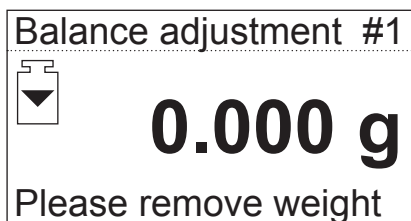

After a short time you will be asked to remove the adjustment weight. Remove the weight from the sample pan.

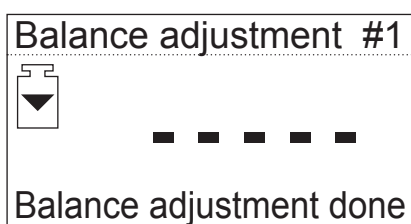

The instrument will provide brief confirmation of the completion of adjustment and then return to the normal operating state.

The Moisture Analyzer is now ready for further measurements.

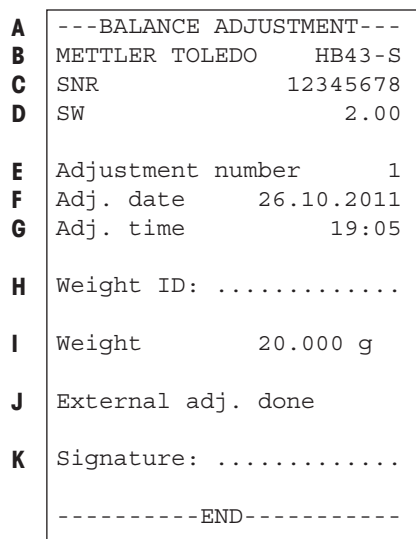

If you have connected a printer to your instrument and this is activated (see section 5.6.9), on completion of the balance adjustment an adjustment record will be automatically printed out with the following data:

- A** Record title
- B** Manufacturer and designation of the instrument
- C** Serial number of the instrument
- D** Version number of the software
- E** Sequence number of the balance adjustment
- F** Date of the balance adjustment
- G** Time of the balance adjustment
- H** Line for entry of the number of the adjustment weight used
- I** Adjustment weight used
- J** Confirmation that the balance adjustment has been performed correctly
- K** Field for signature of the person who performed the balance adjustment

Please enter the number of the adjustment weight used, sign the record and store it in a safe place. This assures traceability, one of the basic requirements of every quality assurance system.

## 5.4 Adjusting the heating module

With this menu item you can adjust the temperature control of the heating module. Consult section 3.2 to learn when an adjustment of the heating module is necessary. We advise you to wait 30 minutes after a drying cycle before performing the adjustment.

Weight adjust.			
Temperature adj. #1			
Language			
∧	∨	Start	Exit

Choose the menu option "Temperature adj." and press «Start».

Dryer unit adj. #1			
📏	🕒 0:00		
Remove pan holder			
		C	

You will be prompted to remove the pan holder from the sample chamber.

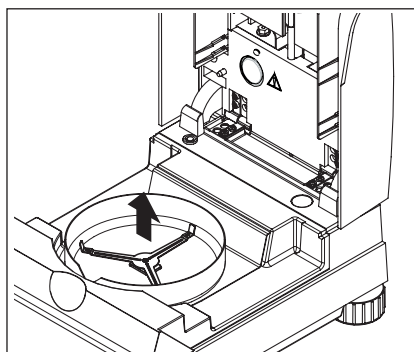

Remove the pan support.

Dryer unit adj. #1			
📏	🕒 0:00		
Insert adjustment kit			
		C	

You will be prompted to insert the adjustment set.

**Note:** You can press «C» to stop temperature adjustment at any time.

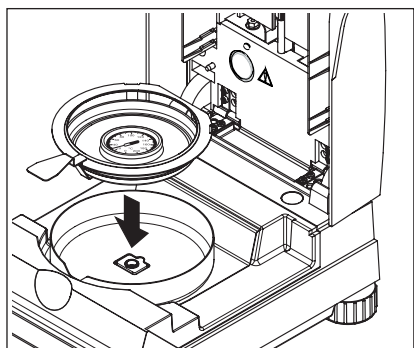

Insert the temperature adjustment set in the sample pan handler.

Place the sample pan handler in the sample chamber.

**Note:** The temperature adjustment set is available as accessories (see section 8.7).

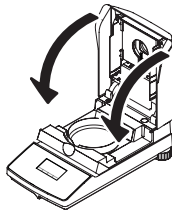

Close the heating module to start the adjustment process, and the heating module adjustment will begin.

Dryer unit adj. #1			
	5:35	100 °C	
Heating to 100 °C...			
		C	

The heating module is heated to a temperature of 100 °C. You can follow this process on the temperature display. The instrument now waits 15 minutes until the temperature adjustment set shows the correct temperature, a beep is then given.

Dryer unit adj. #1			
	15:00	100 °C	
Enter actual temp. 101 °C			
-	+		

Read the temperature adjustment set through the inspection window of the heating module (the divisions correspond to 2 °C). Enter this temperature using the «+» and «-» keys. After entering the value, press «←». The temperature must be entered within 10 minutes after the start of the beep, otherwise the adjustment process will be terminated and an error message output.

Dryer unit adj. #1			
	22:44	160 °C	
Heating to 160 °C...			
		C	

As this adjustment is a two-point adjustment (adjustment of the temperature is defined by two points, namely 100 °C and 160 °C), the heating module now heats to the second temperature (160 °C) . Proceed exactly as you did for the first temperature. After you have confirmed your entry with «←», the adjustment is at an end and the instrument automatically quits the menu and returns to the standby mode.

When the adjustment is complete, you can open the heating module and remove the sample pan support and temperature adjustment set.

**Warning: As the temperature adjustment set can still be hot, allow them to cool down before you remove them from the handler.**



```

A -DRYER UNIT ADJUSTMENT--
B METTLER TOLEDO      HB43-S
C SNR                 12345678
D SW                  2.00

E Adjustment number   1

F Temp. reference ID: ....

G Adj. date          26.10.2011
H Adj. time           20:29
I Temp. 100 °C:      101 °C
J Temp. 160 °C:      159 °C

K Dryer unit adj. done

L Signature: .....

-----END-----

```

If you have connected a printer to your instrument and activated it, (see section 5.6.9), on completion of the heating module adjustment an adjustment record will be automatically printed out with the following data:

- A** Record title
- B** Manufacturer and designation of the instrument
- C** Serial number of the instrument
- D** Version number of the software
- E** Sequence number of the heating module adjustment
- F** Line for entry of the number of the temperature adjustment set used (serial number of temperature adjustment set is printed on dial)
- G** Date of the heating module adjustment
- H** Time of the heating module adjustment
- I** Target and actual temperature for the first adjustment point
- J** Target and actual temperature for the second adjustment point
- K** Confirmation of the adjustment
- L** Field for signature of the person who performed the heating module adjustment.

Enter the number of the adjustment disk, sign the record and store it in a safe place. This assures traceability, one of the basic requirements of every quality assurance system.

## 5.5 Selecting the dialog language

You can choose the language in which your instrument is to communicate with you.

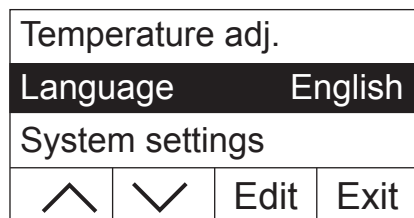

Choose the menu option "Language" and press «Edit».

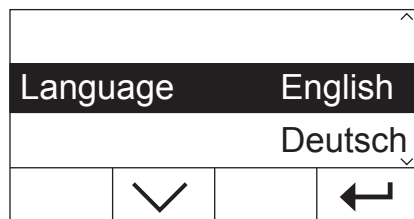

The following languages are available:

- English
- German ("Deutsch")
- French ("Français")
- Italian ("Italiano")
- Spanish ("Español")
- Portuguese ("Portuguese")
- Japanese ("Nihongo")
- Russian ("Russian")

Select the desired dialog language and then confirm your entry with «←».

**Note:** The instrument is preset to the language of the country of destination.

## 5.6 System settings

You use this menu option to specify the basic settings for your instrument.

Language			
System settings			
Interface			
^	v	Sel.	Exit

Choose the menu option "System settings" and press «Sel.».

Time 16.43			
Date			
	v	Edit	←

The display shows a list of all of the system settings. You will familiarize yourself with these settings in the following sections.

To change a setting, choose it with the arrow keys then press «Edit».

With «←» you return to the next-higher menu level.

### 5.6.1 Setting the time

Your Moisture Analyzer is fitted with a built-in clock. The current time and time (see next section) are printed out on each report. When you put your new instrument into operation for the first time (and at the changeover from summer to winter time), you should enter the current time, this setting is retained even if you disconnect your instrument from the power supply.

Time 17:12			
-	+		←

From the System settings menu choose the option "Time" and press «Edit».

You can use the «+» and «-» keys to set the time (in the chosen time format, see section 5.6.3). **Note:** Pressing the key and holding it down adjusts the time in larger increments.

Confirm the new time with «←». The next-higher menu level will then be displayed again.

### 5.6.2 Entering the date

Entering the date is only necessary the first time you put your instrument into operation. The current date is printed out on each report.

Date 12.01.2007			
-	+		←

From the System settings menu choose the option "Date" and press «Edit».

You can use the «+» and «-» keys to set the date (in the chosen date format, see section 5.6.4). **Note:** Pressing the key and holding it down adjusts the date in larger increments.

Confirm the new date with «←». The next-higher menu level will then be displayed again.

### 5.6.3 Choosing time format

You can choose between different ways of displaying the time.

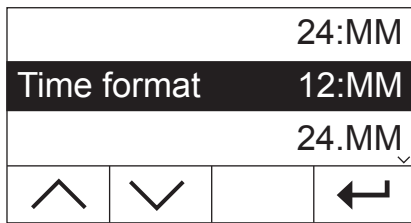

From the System settings menu choose the option "Time format" and press «Edit». Use the arrow keys to choose the required time format:

Setting	Display (example)
24:MM (factory setting)	16:42
12:MM	4:42 PM
24.MM	16.42
12.MM	4.42 PM

Confirm the new time format with «←». The next-higher menu level will then be displayed again.

### 5.6.4 Choosing date format

You can choose between the European (day.month.year = factory setting) and the American date format (month/day/year).

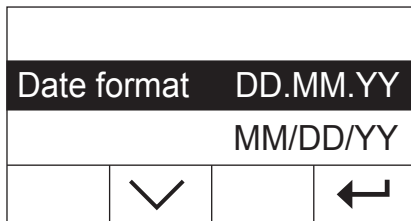

From the System settings menu choose the option "Date format" and press «Edit».

Use the arrow keys to choose the required date format ("DD.MM.YY" = day.month.year, "MM/DD/YY" = month/day/year).

Confirm the new time format with «←». The next-higher menu level will then be displayed again.

### 5.6.5 Setting display contrast

You can adjust the contrast of the display of your instrument to suit your needs.



From the System settings menu choose the option "Contrast" and press «Edit».

You can use the «+» and «-» keys to set the contrast (range: 0 – 100).

Confirm the new setting with «←». The next-higher menu level will then be displayed again.

### 5.6.6 Setting display brightness

You can adjust the brightness of the display of your instrument to suit your needs.

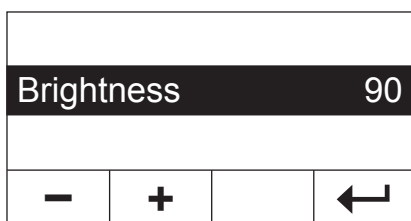

From the System settings menu choose the option "Brightness" and press «Edit».

You can use the «+» and «-» keys to set the brightness (range: 0 – 100).

Confirm the new setting with «←». The next-higher menu level will then be displayed again.

## 5.6.7 How to activate the protection of menu settings

You can protect the menu settings against being changed unintentionally. **The instrument is set in the factory to allow the menu settings to be changed** (menu protection deactivated).

Menu protection		Off
		On
∨		←

From the System settings menu choose the option "Menu protection" and press «Edit».

If you wish to protect the settings against change, switch Menu protection on ("On").

Confirm the setting with «←». The next-higher menu level will then be displayed again.



After Menu protection has been switched on, all of the menu settings are locked and the display shows the padlock symbol (instead of the «Edit» key). You can now only change the Menu protection setting.

## 5.6.8 Selecting the start mode for drying

You can select whether **drying** should be started **automatically or manually**. In the factory your instrument is already set to automatic drying.

In **automatic start mode** the instrument tares, determines the initial (wet) weight and begins drying when the heating module is closed. This "SmartStart" function enables you to perform the entire drying process without pressing a single key.

In **manual start mode** drying does not start automatically when the heating module is closed. When the «Start» key is pressed the initial (wet) weight, which is important for determining the moisture content, is recorded. This can be done with the heating module open or closed. Drying only begins when the heating module is subsequently closed. We recommend manual start mode for samples which contain highly volatile substances. In manual start mode you have time for further preparation of the sample (e.g. mixing the sample with silica sand, or distributing it evenly) because weight lost by evaporation during the preparation time is already recorded. In manual start mode you can even open the heating module while drying is taking place. If this is done, the drying process is not terminated (as it is in automatic mode) but only the heating is switched off until the heating module is closed again.

Start mode		Auto
		Manual
∨		←

From the System settings menu choose the option "Start mode" and press «Edit».

Use the arrow key to choose the required operating mode.

Confirm the setting with «←». The next-higher menu level will then be displayed again.



## 5.6.9 Switching the printer on or off

You can switch the external printer on or off. **In the factory this item is switched on.**

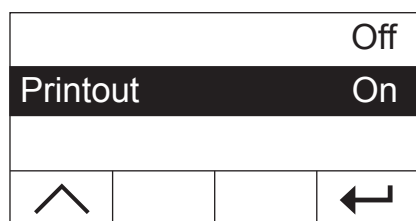

From the System settings menu choose the option "Printout" and press «Edit».

Switch the printer on or off with the arrow key.

Confirm the setting with «←». The next-higher menu level will then be displayed again.

**Note:** The printer must be **switched off** if you want to connect the HB43-S to a computer via the serial interface. This prevents the HB43-S from sending characters to the computer in an uncontrolled manner. It permits data exchange to take place without interference using the MT-SICS interface commands (section 8.6).

When you switch the printer on, you must ensure that the interface settings on the menu of the instrument (section 5.7) match those of the printer.

When you have switched the printer on, an additional menu option is available, which will be explained in the following section.

## 5.6.10 Defining the print interval

**This setting option is only available if the printer is activated** (see section 5.6.9). The print interval determines the printout frequency of the intermediate results of an ongoing measurement.

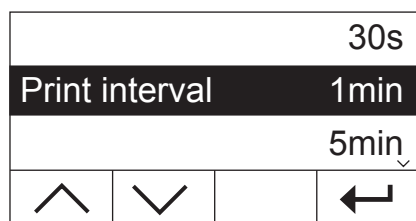

From the System settings menu choose the option "Print interval" and press «Edit».

Use the arrow keys to choose the required print interval. The three settings "30s" (factory setting), "1min" and "5min" allow automatic printout of the intermediate results at fixed intervals. This allows you to follow the drying process using the printed record. With the "Manual" setting there is no automatic printout. However, you can print out intermediate results at any time with the «» key.

Confirm the setting with «←». The next-higher menu level will then be displayed again.

## 5.7 Interface settings

A separate menu option is available for setting the communication parameters of the built-in serial RS232C interface.

System settings			
Interface			
Factory reset			
^	v	Sel.	Exit

Choose the menu option "Interface" and press «Sel.».

Baudrate		9600	
Bit / Parity			
	v	Edit	←

The display shows a list of all of the interface settings. You will familiarize yourself with these settings in the following sections.

To change a setting, choose it with the arrow keys then press «Edit».

With «←» you return to the next-higher menu level.

### 5.7.1 Setting the baud rate (data transmission speed)

The data transmission speed (baud rate) determines speed of transmission across the serial interface. The unit is the baud (1 baud (bd) = 1 bit/second).

		1200	
Baudrate		2400	
		9600 v	
^	v		←

From the Interface settings menu choose the option "Baud rate" and press «Edit».

Use the arrow keys to choose the required data transmission speed. The following settings are available: 1200 bd, 2400 bd (factory setting), 9600 bd, and 19200 bd.

Confirm the setting with «←». The next-higher menu level will then be displayed again.

### 5.7.2 Setting bit / parity

With this menu item you can set the character format for transmission across the serial interface.

		7/No	
Bit / Parity		7/Even	
		7/Odd v	
^	v		←

From the Interface settings menu choose the option "Bit / Parity" and press «Edit».

Use the arrow keys to choose the required setting. The following settings are available:

Setting	Effect
7/No	7 data bits, no parity
7/Even (factory setting)	7 data bits, even parity
7/Odd	7 data bits, odd parity
8/No	8 data bits, no parity

**Note:** For correct representation of special characters (umlauts, accents, etc.) on a printer you should use the setting "8/No".

Confirm the setting with «←». The next-higher menu level will then be displayed again.

### 5.7.3 Setting the data flow control ("Handshake")

With this menu option you can set data flow control ("Handshake").

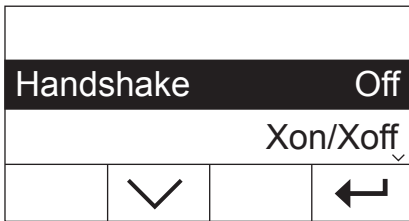

From the Interface settings menu choose the option "Handshake" and press «Edit».

Use the arrow keys to choose the required setting. The following settings are available:

Setting	Effect
Off (factory setting)	No data flow control
Xon/Xoff	Data flow control via software
RTS/CTS	Data flow control via hardware

Confirm the setting with «←». The next-higher menu level will then be displayed again.

## 5.8 Resetting to the factory settings

You have the option of resetting the basic settings of the instrument to the factory settings.



Choose the menu option "Factory reset" and press «Start». You are asked whether you really want to activate the factory settings.



**Warning: If you answer the question with "Yes" all of the individual settings will be replaced with the factory settings! However, time, date, dialog language, contrast, brightness and method parameters will not be reset.** You can deliberately reset the method parameters by allocating a method from the method database to the corresponding method key.

After being reset to the factory settings, the instrument automatically returns from the menu to the normal operating state.

# 6 Servicing and replacing individual parts

In this section you will learn how to keep your Moisture Analyzer in good condition and how to replace expendable parts.

## 6.1 Cleaning the heating module and the sample chamber

To obtain precise measurement results, we recommend you to clean the temperature sensor and the protective glass of the halogen lamp regularly. Please note the following directions for cleaning your instrument:

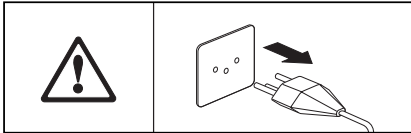

Disconnect the instrument from the power supply before cleaning.

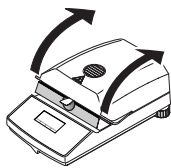

Open the heating module.

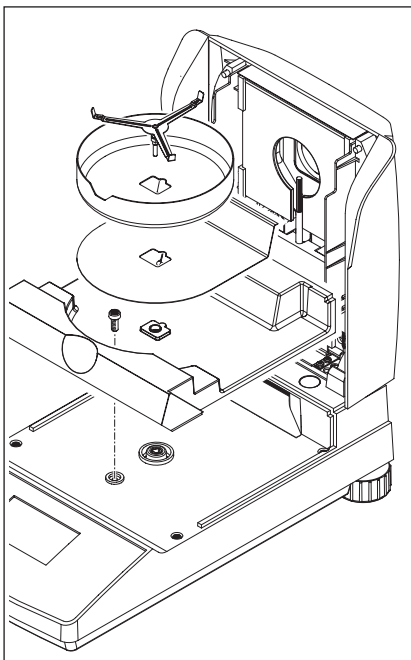

The draft shield, sample pan support and heat shield can be removed for cleaning without tools.

To dismantle the sample chamber you need a normal, commercially available screwdriver.

Use a lint-free cloth for cleaning.

Clean the exterior of the instrument with a mild cleaning agent. Although the housing is extremely rugged and resistant to solvents, never use abrasive cleaning agents or solvents!

Ensure that no liquid enters the interior of the instrument.

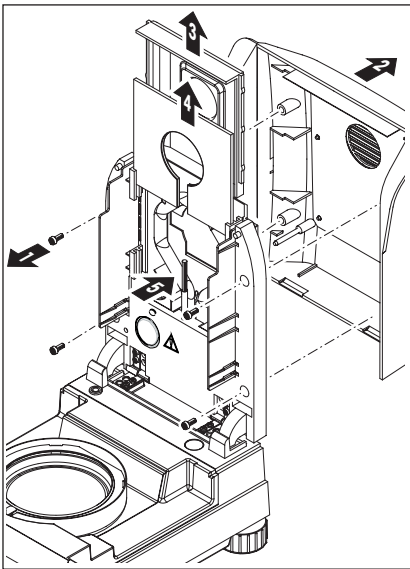

To dismantle the heating module the four screws (1) must be unscrewed. A screwdriver is needed for this purpose (Torx T-20).

Following this, the cover (2) of the heating module can be pulled off toward the back.

The gold-plated reflector (3) and the protective glass of the halogen lamp (4) can be pulled upward and out of the guide rails of the heating module.

Clean the reflector and the protective glass of the halogen lamp with a mild cleaning agent.

Carefully remove any deposits from the black temperature sensor (5).

Avoid touching the round halogen lamp. If you have to remove any splashes, deposits, or spots of grease from the halogen lamp, it is advisable to use a weak organic solvent such as, for example ethanol.



After the temperature sensor has been cleaned, we recommend you adjust the heating module (see section 5.4).

## 6.2 Replacing the power line fuse

If the display of your instrument remains "dark" after switching on, this is most probably because the instrument's power line fuse is defective.

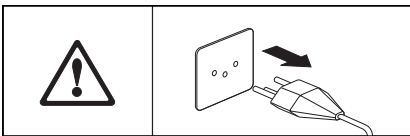

To change the fuse, proceed as follows:

Disconnect the instrument from the power supply.

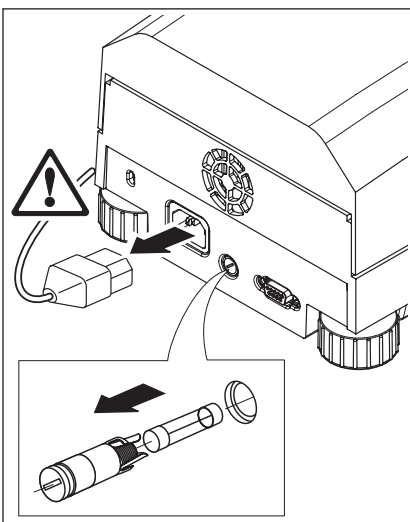

The power line fuse is located on the back of the instrument. Using a screwdriver, turn the fuse holder anticlockwise and pull it out of the instrument.

Check the condition of the fuse. Replace a blown fuse with a fuse of the same type and with the same rated value (5 x 20 mm, T6.3 H 250 V).



**Do not use a fuse of a different type or rated value, or short out (bridge) the fuse, because this can put your safety at risk and damage the instrument!**

## 6.3 Connecting to an external printer

To prepare the printer for use, proceed as follows:

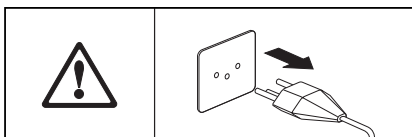

Disconnect the instrument from the power supply.

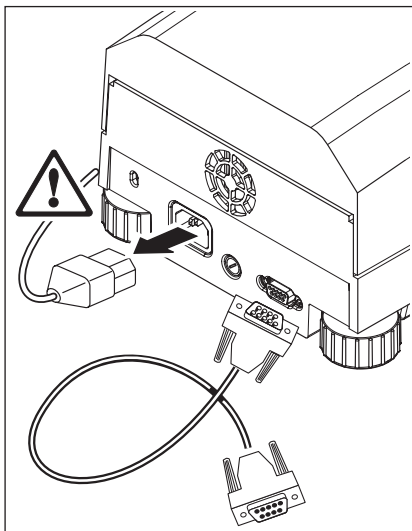

Connect the printer. The HB43-S is fitted with a 9-pin (f) socket for this purpose. The METTLER TOLEDO RS-P42 and RS-P26 plain paper printers are provided with suitable connection cables.

Connect the instrument and the printer to the power supply.

The following settings are recommended for optimum function (Moisture Analyzer and printer):

Baud rate: 9600  
Bits/parity: 8/No  
Handshake: Xon/Xoff



**Make sure the parameters of the printer and the HB43-S are set to the same values (see sections 5.7.1 and 5.7.2, and the printer's operating instructions).**

If your printer has several character sets (for example, RS-P26), choose the IBM/DOS set.

# 7 If problems arise on occasion

In this section you will learn how errors can appear during operation of your Moisture Analyzer and how you can rectify these errors.

## 7.1 Error messages

Your instrument distinguishes between the three different types of errors explained in the following sections.

### 7.1.1 Input errors

If you press a key that is not in use (for example, the «» key with the printer switched off) or whose use is not permitted in the current operating state, your instrument will indicate this input error with a short beep.

### 7.1.2 Application errors

An application error occurs when the instrument cannot perform a procedure or a corrective action is necessary as the limits of a value range have been violated or because a general operating error exists. Application errors are reported by your instrument with a beep. Furthermore, the message "E" ("Error") appears in the display followed by the error number and error message text. Before you can continue working, you must delete the error message with «OK» or with the «» key. You will find a list of all application errors below.

Display	Cause	Remedy
E1 Weight unstable	No stability during taring or adjustment	Ensure stable ambient conditions and an optimum location. Also take care that no part of the sample or the sample pan touch the draft shield or the sample pan handler. Highly volatile substances in the sample also prevent a stable weighing result being detected
E2 Wrong adjustment weight	Either no weight, or the wrong weight, has been placed on the sample pan during adjustment. This message is also displayed if you do not remove the weight when prompted to do so by your instrument.	Repeat the adjustment process and load the required adjustment weight
E3 Sample weight too low	Sample weight below 0.5 g	Weigh in a sample of at least 0.5 g

<b>Display</b>	<b>Cause</b>	<b>Remedy</b>
E4 Missing tare weight	Sample pan has not been tared before the start of drying	Tare sample pan
E8 Temp. entry missing	During adjustment of the heating module, the wait time of 10 minutes for entry of the temperature value has been exceeded	Repeat heating module adjustment and enter temperature values before elapse of the wait time

### 7.1.3 Function errors

Function errors indicate that a program or hardware error exists. In such a case, disconnect the instrument from the power supply. Should the error reappear after reconnection to the power supply, contact your METTLER TOLEDO dealer to arrange an appointment for diagnosis and repair. Note the error number in order to facilitate the work of the service engineer.

<b>Display</b>	<b>Cause</b>	<b>Remedy</b>
E9 Function error + code	Undefined condition	Pull out the power supply plug and allow the instrument to cool for at least 5 minutes. If this error occurs repeatedly, please contact your METTLER TOLEDO dealer and inform him of the displayed code
E11 Adjustment data lost	The heating module and balance adjustment data, and the method and menu settings, have been lost. Cause: Power interruption while being stored	Readjust heating module and balance and reset.



## 7.2 What if...?

### ... the display remains "dark" after switching on?

- no line voltage
- power cable not connected
- blown power line fuse
- instrument faulty

Ensure that the instrument is connected to the power supply and that power is actually supplied. Check the power line fuse of the instrument and replace if necessary (see section 6.2). If the instrument still refuses to function, contact your METTLER TOLEDO dealer.

### ... after switching on "0.000" flashes on the display?

The sample pan holder is not installed. Install the sample pan holder.

### ... the symbol of the stability detector is continuously lit up immediately after the start?

As soon as the symbol of the stability detector fades, the weighing result is stable and is accepted as a "wet weight". If the symbol does not fade, your instrument is probably at an unsuitable location (vibrations, shocks, powerful drafts, etc.). Seek a more suitable location.

Samples containing readily volatile substances may never reach stability owing to continuous evaporation. In this case you must select manual operating mode for the drying unit (see section 5.6.8).

### ... the printer that is connected does not print?

Ensure that the printer is activated on the menu (see section 5.6.9) and that the ribbon and paper are correctly installed. Check the transmission rate, bit/parity and handshake (see section 5.7).

### ... incorrect characters are printed?

Change the bit/parity setting of your printer and HB43-S to "8/No". Check to see if both instruments have the same baud rate setting and use the same character set (see sections 5.7 and 6.3).

### ... no drying time can be entered in the menu?

Entry of the drying time is possible only if you have selected the switch-off criterion "Timed switch-off", with all other switch-off criteria this input possibility is not available (see sections 4.4.6. and 4.4.8).

### ... Menu settings cannot be changed?

You have protected the menu settings against change (see section 5.6.7).

### ... the measurement takes too long?

You have selected an unsuitable switch-off criterion (see section 4.4.6).

An excessive amount of sample can also be the cause of slow drying, likewise samples which tend to form a skin which hinders vaporization.

Perform experiment at higher temperature.

### ... the instrument does not heat following the start?

The heating module is overheated and the thermal overload protection has responded. The instrument is equipped with thermal overload protection (bimetallic sensor) which switches off the heating element if overheating occurs. This can be caused, for example, by a burning sensor.

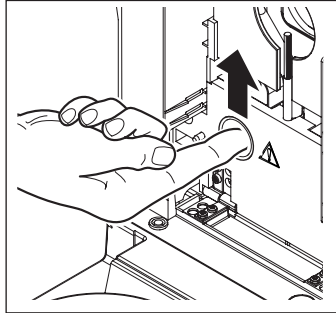
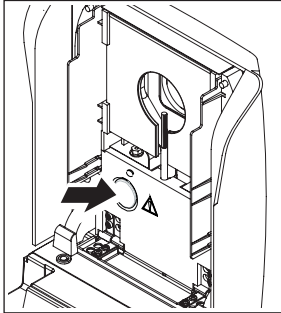

#### Reset the overload protector

**Warning:** The instrument may still be hot!

1. Disconnect the instrument from the power supply.
2. Use a screwdriver to remove the cover.
3. Use a finger to reset the overload switch.
4. Replace the cover and reconnect the instrument to the power supply.

**Note:** If this is not possible, there may be a fault (e.g. a faulty halogen heating module). In such a case, contact your METTLER TOLEDO dealer.

After the temperature switch is reset or a heating module replaced (section 6.1) we recommend that you readjust the heating module of your Halogen Moisture Analyzer (section 5.4).

### ... the measurement results are not repeatable?

- The samples are not homogeneous, i.e. they have different compositions. The more inhomogeneous a sample, the larger the amount of sample needed to obtain a repeatable result.
- You have selected a drying time that is too short (for the "Timed switch-off" criterion). Extend the drying time or select a suitable switch-off criterion "Weight loss per unit of time".
- The sample does not become completely dry (e.g. owing to skin formation). Dry the sample with the aid of glass fiber discs (see section 3.3).
- You have selected a temperature that is too high and the sample has oxidized. Lower the drying temperature.
- The sample boils and the splashed drops continuously change the weight. Lower the drying temperature.
- Insufficient heating power because the protective glass of the halogen lamp is dirty. Clean the protective glass of the halogen lamp (see section 6.1).
- The temperature sensor is contaminated or faulty. Clean the temperature sensor (see section 6.1) or have it replaced by a service engineer.
- The support on which the instrument is standing is not sufficiently stable. Use a stable support.
- The surroundings are very unstable (vibrations etc.).

## 8 Further useful information

### 8.1 Notes on interpretation of the measurement results and the ideal sample weight

The accuracy of the measurement results depends on the wet weight and the original moisture of the sample. The relative accuracy of the measurement result improves with increasing wet weight. While the moisture of the sample is fixed, the weight of the sample can frequently be determined by the user. However, with increasing weight the drying process is lengthened. **We thus advise you to select the weight of your sample to obtain the repeatability you require.**

The target weights specified in the predefined methods (section 4) generally lead to adequate repeatability.

You will find further information in the application brochure (section 8.3).

### 8.2 RS232C interface

So that your Moisture Analyzer can be connected to a peripheral device (e.g. printer or computer) it is fitted with an RS232C interface as standard.

#### 9-pin socket

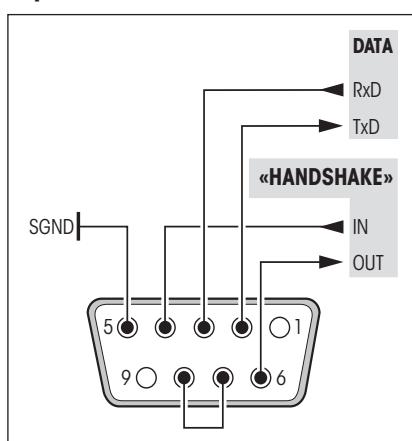

To adapt the HB43-S to the peripheral device the interface parameters can be set on the menu (see section 5.7).

The many ways in which the HB43-S Moisture Analyzer can document results can only be fully utilized if a printer is connected, for example the METTLER TOLEDO RS-P26 or RS-P42. The printed results are a decisive contribution to simplifying working procedures in accordance with GLP/GMP.

For interface commands please refer to the "Reference Manual METTLER TOLEDO Standard Interface Command Set" 11781024, available from your METTLER TOLEDO dealer or downloadable from the Internet ([www.mt.com/moisture](http://www.mt.com/moisture)). More Information is found in section 8.6.

### 8.3 Application Brochure

The application brochure for moisture determination from METTLER TOLEDO (order number: 11796096, [www.moisture-guide.com](http://www.moisture-guide.com)) contains a great deal of useful information for optimum utilization of your Moisture Analyzer. One brochure is included with your HB43-S. To order additional copies, please contact your METTLER TOLEDO dealer.

Example methods and applications can be found at [www.mt.com/moisture](http://www.mt.com/moisture) and [www.mt.com/moisture-methods](http://www.mt.com/moisture-methods).



**Moisture determination applications must be optimized and validated by the user according to local regulations. Application-specific data provided by METTLER TOLEDO is intended for guidance only.**

## 8.4 Switch-off criterion "Weight loss per unit of time"

With the switch-off criterion "Weight loss per unit of time", drying is automatically ended as soon as the **mean** weight loss ( $\Delta g$  in mg) per unit of time ( $\Delta t$  in seconds) drops below a preset value. 5 levels are preprogrammed in the factory, each with a fixed weight loss per unit of time. Furthermore, the switch-off criterion "Free" allows you to define the weight loss per unit of time yourself.

The following applies to the individually selectable levels:

	$\Delta g$ in mg	$\Delta t$ in seconds
Switch-off criterion 1	1 mg	10 seconds
Switch-off criterion 2	1 mg	20 seconds
Switch-off criterion 3	1 mg	50 seconds
Switch-off criterion 4	1 mg	90 seconds
Switch-off criterion 5	1 mg	140 seconds
Switch-off criterion "Free"	1 mg	20 seconds to 180 seconds

The graph below exemplifies the mode of operation of the switch-off operation (not to scale).

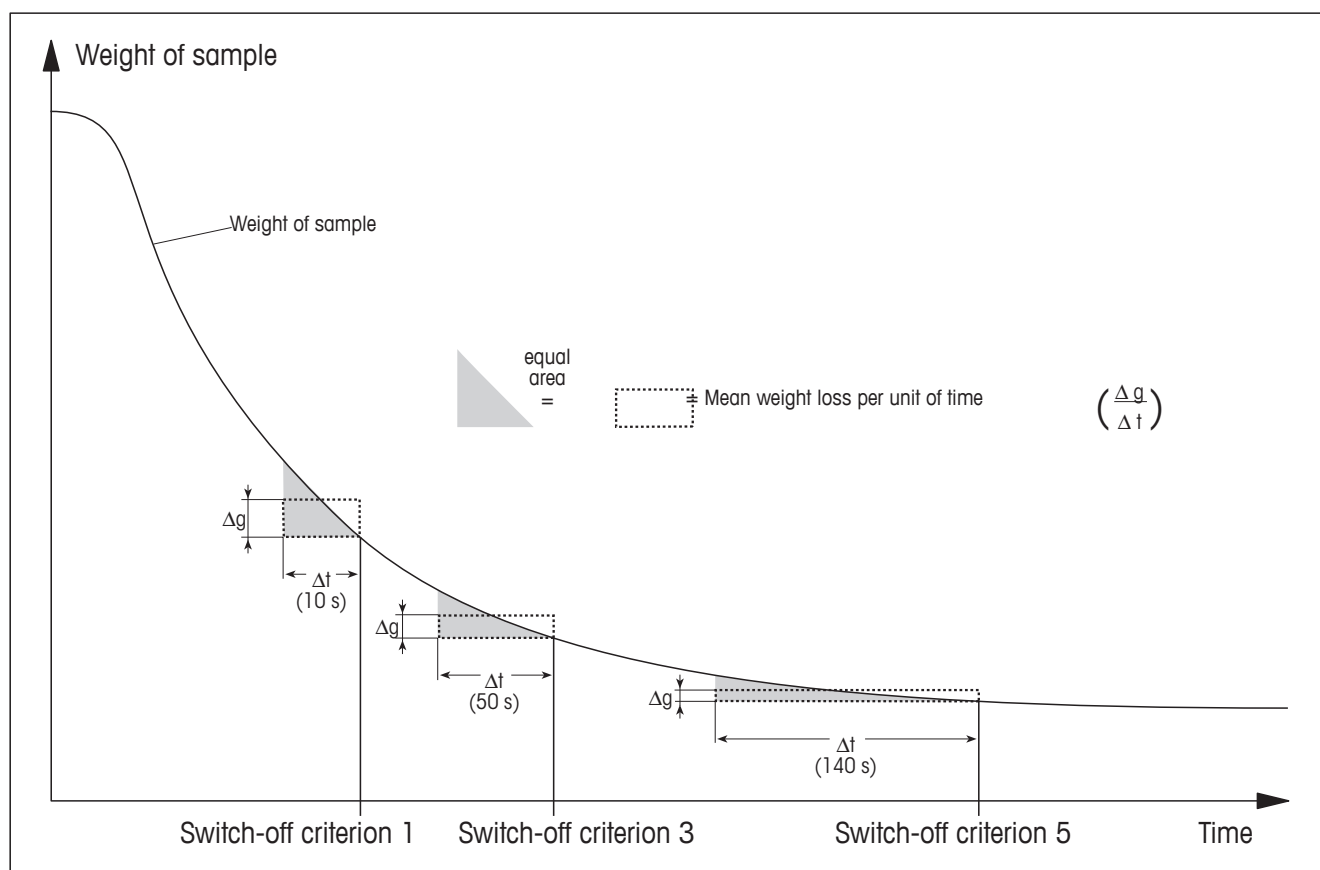

### Key

Switch-off criterion 1 (rapid availability of the result, suitable for determination of a trend)

Switch-off criterion 3 (standard setting)

Switch-off criterion 5 (suitable for precision measurement)

## 8.5 Technical data

Please note that the Moisture Analyzer will undergo continuous further development in the interest of the users. METTLER TOLEDO thus reserves the right to change all technical data at any time and without prior notification.

---

### Dryer

Heating module:	Halogen ring-shaped radiator
Temperature range:	50–200 °C
Temperature increment:	1 °C
Heating module adjustment:	with temperature adjustment set HA-TC or HA-TCC

---

### Balance

Minimum sample weight:	0.5 g
Maximum sample weight:	54 g
Balance adjustment :	with external weight, 20 g ± 0.1 mg
Stability detector:	with symbol in display
Balance resolution:	1 mg
Result resolution:	0.01%
Repeatability (sd) with 2 g sample:	0.10%
Repeatability (sd) with 10 g sample:	0.015%

---

### Data

Time, date	system clock, fail safe
Operational settings:	read-only memory, fail safe
Switch-off criteria:	5 levels, manual, timed, free
Drying programs:	Standard drying, fast drying, LP16 mode
Drying time:	manual (unlimited), timer: 1 minute to 480 minutes
Reset protection:	by locking the menu settings

---

### Evaluation

Display modes:	5 modes: moisture content (MC), dry content (DC), weight (g), ATRO moisture content (AM), ATRO dry content (AD)
Records:	Using external printer (optional)

---

---

## Hardware

Audio signal:	Provided
Data interface:	Built-in RS232C interface
Inspection window:	in heating module
Leveling:	2 leveling screws and level indicator
Display:	Backlit matrix display
Status display (User Guide):	integrated in display
Sample pan, $\varnothing$ :	90 mm
Thermal overload protection:	bimetallic-element switch in heating module
Dimensions (w x h x d):	23 x 15 x 36 cm (see also following dimension diagram)
Weight, ready to measure:	4.3 kg

---

## Admissible ambient conditions

	Use only in closed rooms
Height above mean sea level:	Up to 2000 m
Temperature range:	5 °C to 40 °C
Atmospheric humidity:	80% rh @ + 30 °C
Warm-up time:	At least 60 minutes after connecting the instrument to the power supply; when switched on from standby-mode, the instrument is ready for operation immediately.
Voltage fluctuations:	-15%+10%
Overvoltage category:	II
Pollution degree:	2
Power load:	Max. 450 W during drying process
Current consumption:	4 A or 2 A, according to the heating module
Power supply voltage:	100 VAC – 120 VAC or 200 VAC – 240 VAC, 50/60 Hz (the voltage is determined by the heating module)
Power line fuse:	1 piece, 5 x 20 mm, T6.3 H 250 V

---

## Dimensions

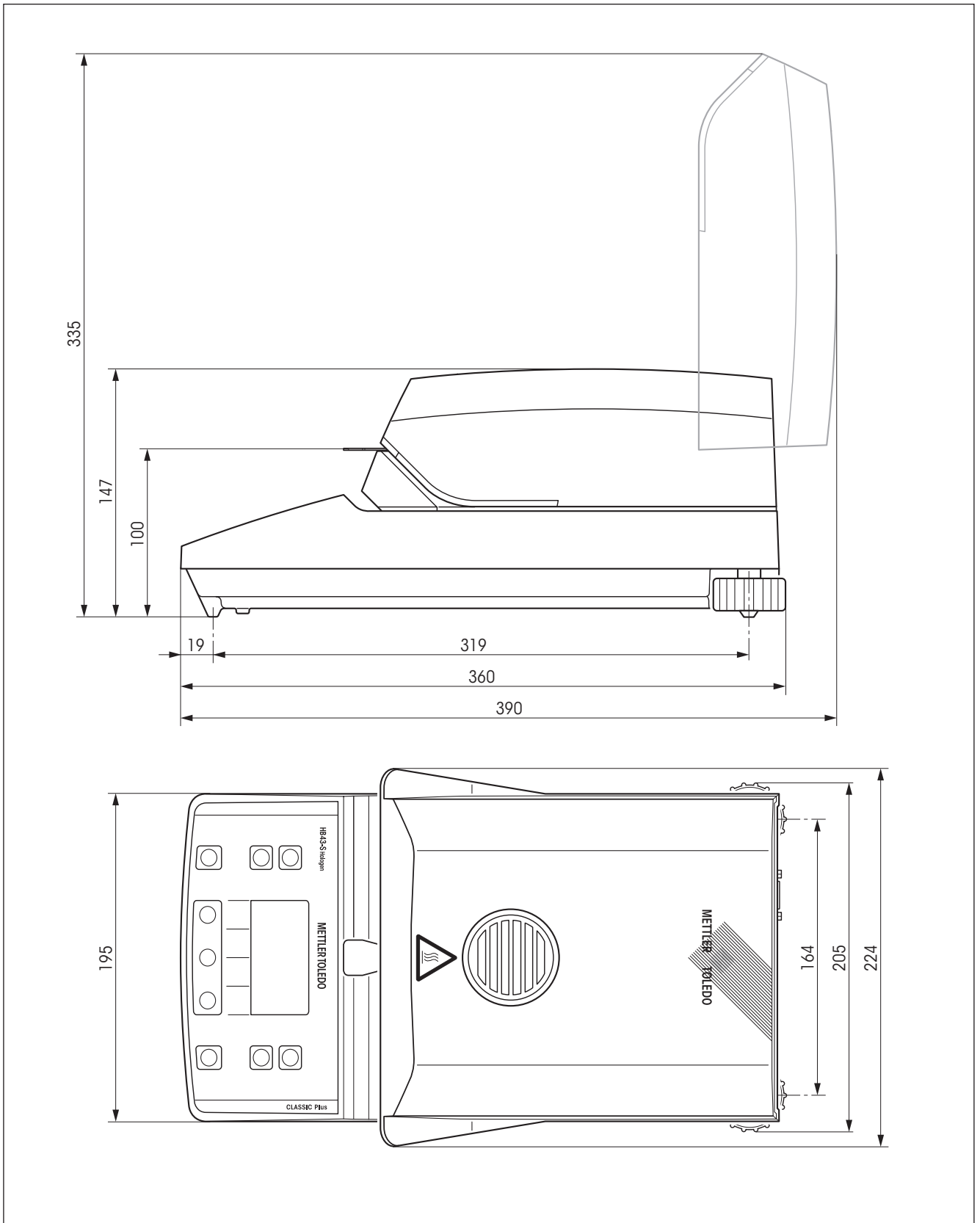

## 8.6 MT-SICS Interface commands and functions

Many of the instruments and scales used have to be capable of integration into a complex computer or data acquisition system. To enable you to integrate instruments into your system in a simple manner and utilize their capabilities to the full, most instrument functions are also available as appropriate commands via the data interface. All new METTLER TOLEDO instruments launched on the market support the standardized command set "METTLER TOLEDO Standard Interface Command Set" (MT-SICS). The commands available depend on the functionality of the instrument.

### Basic information on data interchange with the instrument

The instrument receives commands from the system and acknowledges the command with an appropriate response.

### Command formats

Commands sent to the instrument comprise one or more characters of the ASCII character set. Here, the following must be noted:

- Enter commands only in uppercase.
- The possible parameters of the command must be separated from one another and from the command name by a space (ASCII 32 dec., in this description represented as `␣`).
- The possible input for "text" is a sequence of characters of the 8-bit ASCII character set from 32 dec to 255 dec.
- Each command must be terminated with `CRLF` (ASCII 13 dec., 10 dec.).

The characters `CRLF` which can be inputted using the Enter or Return key of most entry keypads, are not listed in this description, but it is essential they be included for communication with the instrument.

### Example: S – Send stable weight value

Command	<code>S</code>	Send the current stable net weight value.
Response	<code>S␣S␣WeightValue␣Unit</code>	Current stable weight value.
	<code>S␣I</code>	Command not executable (instrument is currently executing another command, e.g. taring, or timeout as stability was not reached).
	<code>S␣+</code>	Instrument in overload range.
	<code>S␣-</code>	Instrument in underload range.

### Example

Command	<code>S</code>	Send a stable weight value.
Response	<code>S␣S␣␣␣␣␣␣␣30.000␣g</code>	The current, stable weight value is 30.000 g.

For the MT-SICS commands available for your instrument and further information please refer to the Reference Manual "MT-SICS for Moisture Analyzers 11781024" downloadable from the Internet under [www.mt.com/moisture](http://www.mt.com/moisture).



## 8.7 Accessories, consumables and spare parts





If you require other spare parts for your Moisture Analyzer, please contact your METTLER TOLEDO dealer.

### 8.7.1 Accessories

	Description	Part No.
	<b>Adjustment weight</b> Adjustment weight 20 g (Class F1 (Adjustment of balance))	00158640
	<b>Temperature adjustment set</b> Temperature adjustment set, HA-TC (Adjustment of heating module) Calibrated temperature adjustment set, HA-TCC (including test certificate) (Adjustment of heating module)) Recalibration from HA-TCC, HA-TCCRe (including test certificate) (Recalibration with certificate)	00214455 00214528 00214534
	<b>Sample pan</b> Reusable sample pan (steel, height: 6 mm), HA-DR1, Set of 3 pieces Reusable sample pan (steel, height: 15 mm), 1 piece	00214462 00013954
	<b>Transport case</b>	11113855
	<b>Sample pan handler</b> Sample pan handler, HA-PH, 3 pieces	00214526
	<b>Protective cover</b> Chemically resistant protective cover, 2 pieces	11113363
	<b>Printer</b> Printer RS-P42 Printer RS-P26	00229265 12120788
	<b>Cables for RS232C Interface</b> RS9 – RS9 (m/f): Connection cable for PC or printer RS232C, length = 1 m	11101051
	<b>Antitheft device</b> Steel cord	11600361

	<b>Description</b>	<b>Part No.</b>
	<b>SmartCal</b>	
	cSmartCal, 24 tests	30005791
	cSmartCal, 12 tests	30005793
	SmartCal, 24 tests	30005790
	SmartCal, 12 tests	30005792
	<b>StarterPac SmartCal</b>	
	StarterPac cSmartCal, 12 tests	30005918
StarterPac SmartCal, 12 tests	30005917	

## 8.7.2 Consumables

	<b>Description</b>	<b>Part No.</b>
	<b>Printer paper</b>	
	Printer paper, Set of 5 rolls	00072456
	Paper roll (self-adhesive) for printer, Set of 3 rolls	11600388
	<b>Ribbon</b>	
	Ribbon (cassette, black) for printer, Set of 2 pieces	00065975
	<b>Sample pan</b>	
	Aluminum sample pan ø 90 mm, HA-D90, Set of 80 pieces	00013865
	Reinforced aluminum sample pan ø 90 mm, 1 piece	11113863
	<b>Glass fiber filter</b>	
	Glass fiber filter (for liquids), HA-F1, Set of 100 pieces	00214464

### 8.7.3 Spare parts

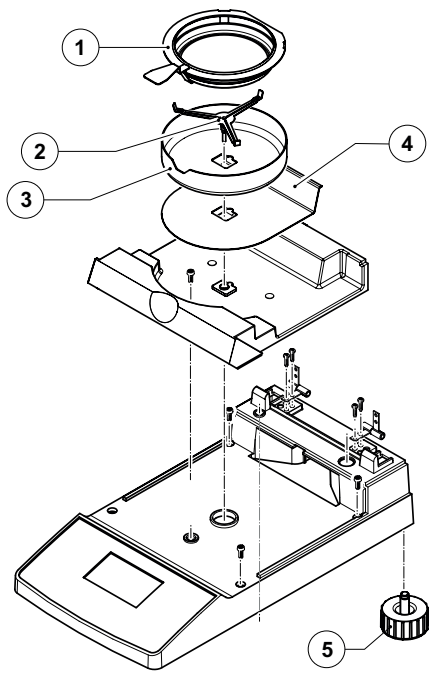

Pos	Description	Part No.
1	Sample pan handler	11113873
2	Sample pan support	00214642
3	Draft shield	00214368
4	Heat shield	11113360
5	Leveling screw	11101302

# 9 Index

## A

Accessories 65  
Accuracy 59  
Adjusting the balance 41  
Adjusting the heating module 43  
Adjustment 18, 55  
Adjustment process 44  
Adjustment record 42, 45  
Adjustment weight 42, 55, 65  
Air bubble 11  
Anti theft device 65  
Application Brochure 19, 59  
Application error 55  
ATRO dry content 30  
ATRO moisture content 30  
Audio signal 62

## B

Balance adjustment 42  
Baud rate 50, 54, 57  
Beep 44  
Bimetallic sensor 58  
Bit / parity 50, 57  
Burning 8

## C

Cables for RS232C Interface 65  
Character format 50  
Chemically resistant protective cover 65  
Cleaning 52  
Cleaning agent 52, 53  
Communication parameters 50  
Computer 49, 59  
Connection cable 54  
Consumables 66  
Corrosion 8  
Current consumption 62

## D

Database 20  
Data flow control 51

Data interface 62  
Date 46, 61  
Date format 47  
Decimal places 32  
Dialog language 45  
Dimensions 63  
Display 62  
Display brightness 47  
Display contrast 47  
Display mode 29, 61  
Disposal 9  
Draft shield 34, 52, 55, 67  
Dry content 30  
Drying 48  
Drying and measurement 15  
Drying process 59  
Drying program 25, 61  
Drying temperature 17, 25, 26, 58  
Drying time 17, 28, 29, 57, 58, 61

## E

Equipment 10  
Error message 44, 55  
Error message text 55  
Error number 55  
Explosion 8  
Extension cable 12

## F

Factory settings 51  
Fire 8  
Free factor 31  
Free space 7  
Free switch-off 27  
Free switch-off criterion 28  
Function errors 56  
Fuse 53  
Fuse holder 53

## G

Glass fiber filter 13, 19, 66  
GLP 7, 18, 59  
GMP 7, 18, 59  
Good Laboratory Practice 7  
Good Manufacturing Practice 7  
Guide rails 53

## H

Halogen heating module 6  
Halogen lamp 53  
Halogen Moisture Analyzer 6, 17  
Handshake 51, 57  
Heat 7  
Heat accumulation 7  
Heating element 58  
Heating module 6, 7, 12, 13, 14, 15, 17, 18, 27, 33, 34, 35, 43, 44, 48, 53, 58, 61  
Heating module adjustment 27, 56, 61  
Heat shield 52, 67

## I

Initial status 13  
Input errors 55  
Inspection window 44, 62  
Instrument safety 7  
Interface 49, 50  
Interface commands 64  
ISO 9001 7, 18  
ISO 14001 7

## L

Language 45  
Level 11  
Level indicator 11  
Leveling 11, 62  
Leveling screw 67  
Leveling screws 11  
Line voltage 12, 57  
Liquid 52

- LJ16 25
- Location 11, 55, 57
- LP16 25
- M**
- Manual switch-off 27, 28
- Measure-  
ment 10, 13, 20, 33, 57
- Measurement parameters 17
- Measurement principle 17
- Measurement process 36
- Measurement record 35, 37
- Measurement result 59
- Measurement results 35
- Measuring cycle 37
- Menu 38, 57, 59
- Menu overview 38
- Method 20, 23
- Moisture 6, 17, 59
- Moisture content 15, 25, 30
- Moisture determination 59
- MT-SICS 59, 64
- MT-SICS interface commands 49
- N**
- NACE code 21, 23
- O**
- On/Off 33
- Operating concept 20
- Overheating 7, 58
- P**
- Package 10
- Packaging 10
- Padlock symbol 48
- Pan holder 13, 34, 43
- Paper 57
- Paper roll 66
- Parameter 33
- Peripheral device 59
- Personnel qualification 6
- Poisoning 8
- Power cable 7, 12, 57
- Power line fuse 53, 57, 62
- Power supply 11, 12, 52, 56
- Power supply voltage 62
- Printed results 59
- Printer 45, 49, 54, 57, 59,  
61, 65
- Printer paper 66
- Printer RS-P26 54, 59
- Printer RS-P42 54, 59
- Print interval 49
- Printout 49
- Protective glass 7, 52, 53, 58
- Protect the settings 48
- Q**
- Quality assurance system 18,  
42, 45
- R**
- Rapid drying 25
- Ready for start 15
- Ready for taring 13
- Ready for weighing 14
- Reconnection to the power  
supply 56
- Record 37, 41, 42, 45, 61
- Reference Manual 59
- Reflector 53
- Repeatability 59, 61
- Reset 16, 36, 55
- Reset protection 61
- Resetting the thermal overload  
protector 58
- Result display 29
- Reusable sample pan 65
- Ribbon 57, 66
- RS232C interface 50, 59
- S**
- Safety 7
- Sample 13, 19, 28, 33, 48,  
55, 58, 59
- Sample chamber 35, 43, 52
- Sample pan 13, 19, 34, 55,  
62, 65, 66
- Sample pan handler 13, 34, 35,  
43, 55, 65, 67
- Sample pan support 52, 67
- Sample weight 55, 59, 61
- Self-test 13
- Servicing 52
- Setting up 11
- Signal 55
- SmartCal 39, 66
- SmartStart 48
- Soffkeys 21
- Solvent 52, 53
- Spare parts 67
- Specimen sample 13, 14
- Stability 55
- Stability detector 57, 61
- Standard equipment 10
- Start 48, 57, 58
- StarterPac SmartCal 66
- Start mode 48
- Status display 7, 13, 33, 62
- Stop 28, 36, 37
- Stopping measurement 36
- Switch-off criterion 27, 28, 57,  
60, 61
- Switch-off criterion "Weight loss  
per unit of time" 58
- Symbol of the stability detector 57
- System settings 46
- T**
- Target weight 24
- Taring 55
- Technical data 61
- Temperature 35, 44, 57, 58
- Temperature adjustment set 18,  
43, 44, 61, 65
- Temperature entry 56
- Temperature increment 61
- Temperature range 61
- Temperature reduction 26
- Temperature sensor 27, 52, 53,  
58
- Test record 41

Thermal overload protection 58  
Thermal overload switch 58  
Thermogravimetric principle 6  
Time 46, 61  
Timed switch-off 27, 28, 57  
Time format 47  
Time interval 29  
Tolerance 24  
Trained personnel 7  
Transport case 65  
Two-point adjustment 44

## **U**

Unpacking 10  
User Guide 13, 33, 62

## **V**

Vapors 8  
Vent 7

## **W**

Weight 55  
Weight in grams 30  
Weight loss per unit of  
time 27, 60



## **GWP® – Good Weighing Practice™**

The global weighing guideline GWP® reduces risks associated with your weighing processes and helps to

- choose the appropriate balance
- reduce costs by optimizing testing procedures
- comply with the most common regulatory requirements

► [www.mt.com/GWP](http://www.mt.com/GWP)

[www.mt.com/moisture](http://www.mt.com/moisture)

For more information

### **Mettler-Toledo AG Laboratory & Weighing Technologies**

CH-8606 Greifensee, Switzerland

Tel. +41 (0)44 944 22 11

Fax +41 (0)44 944 30 60

Internet: [www.mt.com](http://www.mt.com)

Subject to technical changes.

© Mettler-Toledo AG 12/2011

11780961A en



\* 1 1 7 8 0 9 6 1 \*