

Excellence Plus Balances

XP Models – Part 3



METTLER TOLEDO

Contents

1	Introduction to Adjustments and Tests	4
1.1	Important to know.....	4
1.2	Basic principles for settings and tests	4
1.3	GWPExcellence™.....	4
1.4	The Configuration Process.....	5
1.5	Satisfying Documentation Requirements.....	5
2	Accessing the Adjustments and Tests	6
2.1	Overview: Settings for adjustments and tests	7
3	Settings for Adjustments and Tests	8
3.1	Weights.....	8
3.1.1	Weight Parameters	8
3.2	Test Sequences.....	10
3.2.1	Test Sequence Parameters	11
3.2.2	Settings of the Parameter “Action if Failure” = Warning.....	13
3.2.3	The Method	15
3.2.3.1	Defining Weights and Tolerances for a Method	15
3.2.3.2	EC Method for Eccentricity Test	17
3.2.3.3	RP1 Method for Repeatability Test	18
3.2.3.4	RPT1 Method for Repeatability Test with Tare.....	19
3.2.3.5	SE1 Method for Sensitivity Test with 1 Testpoint.....	20
3.2.3.6	SE2 Method for Sensitivity Test with 2 Testpoints	21
3.2.3.7	SERVICE Method for Reminder / Early Notification.....	22
3.2.3.8	SET1 Method for Sensitivity Test with Tare and 1 Testpoint.....	24
3.2.3.9	SET2 Method for Sensitivity Test with Tare and 2 Testpoints	25
3.3	Tasks	26
3.3.1	Task State	27
3.3.2	Assigning a Test Sequence to the Task.....	27
3.3.3	Starting Method	28
3.3.4	Defined Days	29
3.3.5	Defined Users	30
3.4	ProFACT / int. Adj.	31
3.4.1	Advanced Options.....	32
3.5	Automatic Adjustment Using an External Test Weight.....	33
3.6	Automatic Adjustment Testing Using an External Test Weight.....	34
3.7	Test History	35
3.8	Protocol – defining the Adjustment and Test Reports	36
4	Glossary - GWP Functions	38
5	Index	40

1 Introduction to Adjustments and Tests

These Operating Instructions relate to configuring your XP Balance ready to perform adjustments and tests.



Warning: It is essential that you have read the **Operating Instructions – Part 1 and Part 2** for the XP balances (separate document). **You must also have read the Safety Instructions in Part 1** and assembled and installed the balance according to the operating instructions. The balance must be leveled.

1.1 Important to know

The **default settings** in these Operating Instructions are marked with the symbol **X** after the name of the setting.

Example: **Standard X**



Where applicable, the Factory Setting has been specified. To print out the settings or the report a printer must be connected and activated as the output device in the peripheral settings.

1.2 Basic principles for settings and tests

Balances play a very important role in research, development, quality assurance and production. Errors in weight measurements cost time and money and violations to legal requirements may even cause damage to health. With the **Good Weighing Practice™** from METTLER TOLEDO, the routine testing of your balance is made efficient, accurate and secure. Our **GWPBase™** service provides you with a unique personalized document containing precise recommendations for the routine testing of your balances according to your weighing risk with regards to:

- How to test your balance and when (how often)
- Which weights should be used
- What tolerances are appropriate

You can find more information on our website: www.mt.com/GWPBase

GWPExcellence™ is the part of the balance firmware which has been specially developed to simplify routine testing procedures. In combination with **GWPBase™** you can ensure efficient balance testing to meet your audit requirements.

1.3 GWPExcellence™

GWPExcellence™ is a collection of embedded safety functions for XS/XP Balances. These individually programmable functions simplify routine testing procedures and hence improve the measurement accuracy of your balance. Many of these functions relate to the routine testing of your balance with external test weights and actively support you with requests for a test to be performed at a pre-defined time. Step-by-step user guidance provided on the balance display allows complex procedures, such as a repeatability test, to be performed without error by anyone in the laboratory.

In conjunction with internal sensors, further functions have been developed to avoid measurement error; e.g. temperature sensors can trigger an internal adjustment when the temperature changes more than a pre-defined amount.

In order to ensure that tests are executed as desired and that reports are generated correctly, it is necessary for you to define and maintain all relevant criteria for your tests. Making a record of your tests and adjustments to meet documentation requirements can be easily done by connecting the balance to a printer or PC as desired.

1.4 The Configuration Process

To prepare your balance for performing routine tests and adjustments is a straightforward three step process:

1. **Register your Weights:** The information relating to each of your test weights is entered and stored in a weights database.
2. **Define the Test Sequence:** The Test Sequence describes the type of test (method) to be done and which test weight and tolerance to use.
3. **Create the Task:** The task defines when and how the test sequence should be started and executed.

Section 3 describes all the settings in detail.

1.5 Satisfying Documentation Requirements

To maintain full traceability of your adjustments and tests it is important that you periodically print out your settings and your results from the Test History.

Your results are stored in the test history with a maximum of 120 records. When the limit is reached the oldest results are deleted.

Each time you modify a test sequence the version number is incremented and displayed in the top right hand corner of the balance display. It is recommended that each new version should be printed as a record for your log book.

A complete list of individual settings can be printed out by pressing the  key while the relevant menu is open.

To print out settings and reports a printer must be connected and activated as the output device in the peripheral settings.

2 Accessing the Adjustments and Tests

Access the system settings by either selecting the application menu using the «::::» key or the menu for the user settings using the «☰» key, and then press the **System** button.

The system settings are represented by icons. The individual settings can be called up and changed by touching the icons.

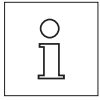

The **system settings** apply to the entire weighing system and therefore to all user profiles and applications.

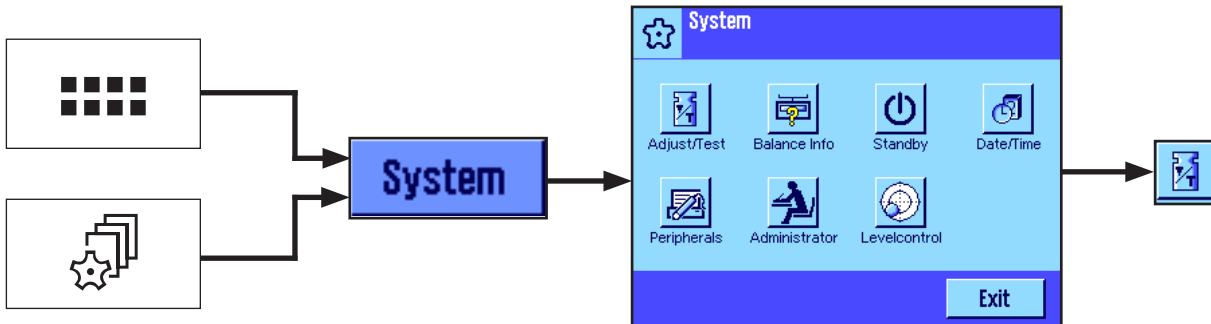

The following system settings are available.

Adjust/Test Set parameters for adjustments and tests (see section 3 of this document).

Detailed instructions to the system settings **Balance Info**, **Standby**, **Date/Time**, **Peripherals**, **Administrator** and **Levelcontrol** can be found in the Operating Instructions – Part 2 for XP balances.

To return to the active application press the **Exit** button.

Press the **Adjust/Test** icon to access the adjustments and tests menu. The following section presents an overview of all the different settings available. Section 3 describes the settings in detail.

2.1 Overview: Settings for adjustments and tests

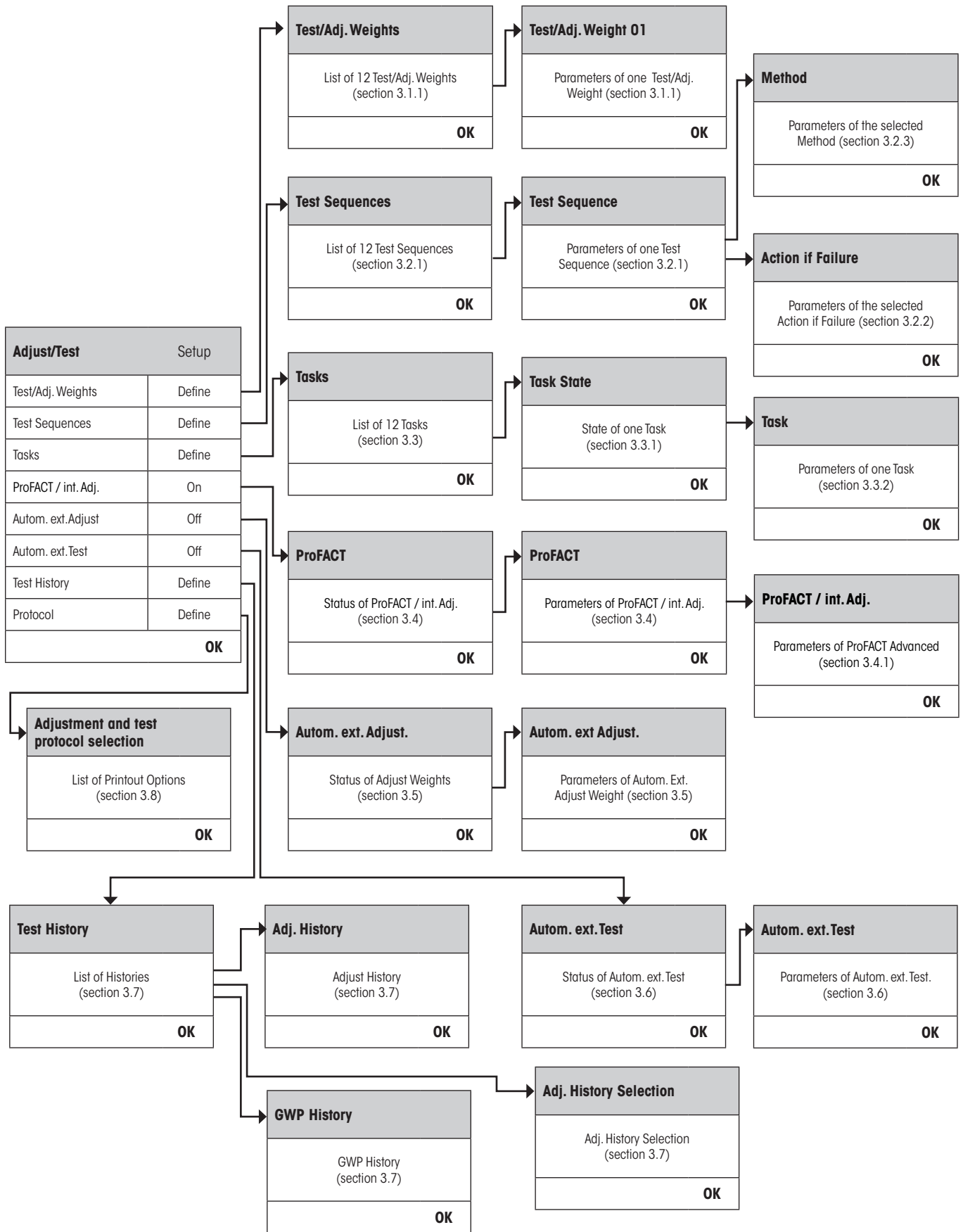

3 Settings for Adjustments and Tests

This section describes all the menu options available for defining the parameters relating to the adjustment and testing of your balance.

3.1 Weights

When "Test/Adj. Weights" is selected you are provided with a list of weights. Up to 12 external test weights can be configured. Select an undefined weight to be configured or the name of the weight whose parameters you wish to update. These test weights are used for performing the external tests and adjustments and the appropriate one will be selected when defining the Test Sequences.

Adjust/Test		Setup						
Test/Adj. Weights	Define	<table border="1"> <thead> <tr> <th colspan="2">Test/Adj. Weights</th> </tr> </thead> <tbody> <tr> <td colspan="2">List of 12 Test/Adj. Weights (section 3.1.1)</td> </tr> <tr> <td colspan="2" style="text-align: right;">OK</td> </tr> </tbody> </table>	Test/Adj. Weights		List of 12 Test/Adj. Weights (section 3.1.1)		OK	
Test/Adj. Weights								
List of 12 Test/Adj. Weights (section 3.1.1)								
OK								
Test Sequences	Define							
Tasks	Define							
ProFACT / int. Adj.	On							
Autom. ext. Adjust	Off							
Autom. ext. Test	Off							
Test History	Define							
Protocol	Define							
OK								









A complete list of the 12 test weights can be printed out by pressing the «» key while the weight list is displayed.

3.1.1 Weight Parameters

Once you have selected a weight, the following parameters can be configured.

Test/Adjust Weights		Setup																			
Test/Adj. Weight 1	Define	<table border="1"> <thead> <tr> <th colspan="2">Test/Adjust Weight 01</th> <th>Setup</th> </tr> </thead> <tbody> <tr> <td>Name</td> <td>Test/Adj. Weight</td> </tr> <tr> <td>Weight ID</td> <td>Define</td> </tr> <tr> <td>Class</td> <td>E1</td> </tr> <tr> <td>Certificate No.</td> <td>Define</td> </tr> <tr> <td>Weight Set No.</td> <td>Define</td> </tr> <tr> <td>Actual Value</td> <td>0 g</td> </tr> <tr> <td>Next Calibration</td> <td>31.12.2099</td> </tr> <tr> <td colspan="2" style="text-align: right;">OK</td> </tr> </tbody> </table>	Test/Adjust Weight 01		Setup	Name	Test/Adj. Weight	Weight ID	Define	Class	E1	Certificate No.	Define	Weight Set No.	Define	Actual Value	0 g	Next Calibration	31.12.2099	OK	
Test/Adjust Weight 01			Setup																		
Name	Test/Adj. Weight																				
Weight ID	Define																				
Class	E1																				
Certificate No.	Define																				
Weight Set No.	Define																				
Actual Value	0 g																				
Next Calibration	31.12.2099																				
OK																					
Test/Adj. Weight 2	Define																				
Test/Adj. Weight 3	Define																				
Test/Adj. Weight 4	Define																				
Test/Adj. Weight 5	Define																				
Test/Adj. Weight 6	Define																				
Test/Adj. Weight 7	Define																				
Test/Adj. Weight 8	Define																				
Test/Adj. Weight 9	Define																				
Test/Adj. Weight 10	Define																				
Test/Adj. Weight 11	Define																				
Test/Adj. Weight 12	Define																				
OK																					

"Name":	Weight Name can be freely defined and is intended to be an easily recognizable form for the user as an alternative to the Weight ID and Certificate No. (E.g. 20g QK).
	Max. 20 characters! Name should be unique and unambiguous.
<hr/>	
"Weight ID":	The ID of the weight is provided on the Weight Certificate. The ID may contain your company specific identification number.
	Max. 20 characters!
<hr/>	
"Class":	The following predefined classes are available to choose from: E1, E2, F1, F2, M1, M2, M3, ASTM1, ASTM2, ASTM3, ASTM4, ASTM5, ASTM6, ASTM7, Own. "Own" can be selected when none of the other classes apply.
<hr/>	
"Certificate No.":	The number of the certificate relating to the weight.
	Max. 20 characters!
<hr/>	
"Weight Set No.":	The number of the certificate relating to the set of weights (if the test weight belongs to a set).
	Max. 20 characters!
<hr/>	
"Actual Value":	Specified on the Weight Certificate. Independent of the balance model, the complete number should be entered regardless of the number of decimal places (e.g. 20.00124 g).
	Methods always use the actual value and the maximum decimal places of the balance will be used for computation.
<hr/>	
"Next Calibration":	Enter the date when the next calibration of the weight is due.
	If the calibration date is unavailable or if no calibration of the weight is planned, the preset value (31.12.2099) will be retained.

3.2 Test Sequences

Test Sequences define which test is to be performed and with which test weights(s). The user is guided through the test with clear instructions on the balance display. The test should be performed in accordance with GWP® or other QM-System. When configuring the Test Sequence you can define the steps to follow should the balance fail the test (see section 3.2.1).

In the example illustrated, Test Sequence 1 has the name "Sensitivity". The rest of the Test Sequences are undefined.



When **Test Sequences** is selected you are provided with a list of tests. Up to 12 Test Sequences can be configured. Select an undefined Test Sequence to be configured or the name of a Test Sequence whose parameters you wish to update.

Test Sequences		Setup
Sensitivity		Define
Test Sequence 2		Define
Test Sequence 3		Define
Test Sequence 4		Define
Test Sequence 5		Define
Test Sequence 6		Define
Test Sequence 7		Define
Test Sequence 8		Define
Test Sequence 9		Define
Test Sequence 10		Define
Test Sequence 11		Define
Test Sequence 12		Define
OK		



A complete list of all parameters of the 12 test sequences can be printed out by pressing the «» key while the test sequence list is open.

3.2.1 Test Sequence Parameters

Once you have selected a Test Sequence the following parameters can be configured. The weights required for the test weights must be previously defined in the **Test/Adjust Weights** menu.

Test Sequence		Setup
Sensitivity		Version 2
Name		Sensitivity
Preparation Instructions		Standard
Method		SE1
Action if Failure		Warning
Instructions if Failure		Standard
Code to Unblock		Z
Entry in GWP History		Yes
OK		



Note: The Test Sequence is saved by pressing "OK" on the Test Sequence menu.



Note: Each time the Test Sequence is saved the Version number will be incremented by 1. The version number is indicated on the top right hand corner of the display when the relevant Test Sequence is open.



Note: The SERVICE Method does not require a test weight.

"Name":



The Test Sequence Name can be freely defined and is intended to be an easily recognizable form for the user to ensure clear identification and easy traceability.

Max. 20 characters!



"Preparation Instructions":	Choose between two settings:
"None" X:	No preparation instructions will be included in your Test Sequence. This is primarily suitable for Test Sequences that do not normally require user interaction, e.g. Test Sequences using the SERVICE Method. For all other Methods, selection of "Standard" is recommended.
"Standard":	The following preparation instructions will be included in your Test Sequence and correspond to those typically found in any standard SOP. The user must execute the instructions and confirm with "OK" before being able to continue with the rest of the defined Test Sequence: The Test Sequence "Name" has started. Please carry out the following: <ol style="list-style-type: none"> 1. Clean the weighing pan. 2. Level the balance. 3. Connect and switch on the printer. 4. Make sure that the test weights are ready. 5. Make sure that the tweezers/weighing forks are ready. When finished - press "OK" and follow the next test sequence instructions.

"Method":	The Method defines the type of test to be performed. Choose from a list of six different Methods. On selecting the Method you will be required to define the test weights and tolerances to be utilized for the test. This is described further in section 3.2.3. Factory Setting: None
------------------	---

"Action if Failure":	Allows you to define how the balance should behave if a test fails or is aborted. Choose from the following three settings:
"None" X:	The user can continue work as normal.
"Warning":	The user can continue work as normal but will receive a specified number of warnings that the Test Sequence has failed and will be prompted to restart the Test Sequence. If the specified number of warnings has been reached and the last restart of the Test Sequence fails, the failed Test Sequence will cause the balance to be blocked.  Note: These settings are described further in section 3.2.2.
"Attempts":	Specify the number of attempts allowed to perform the test. When the number of attempts has been reached and the test has not been successful, the balance will be blocked. In contrast to the Warning setting, it is not possible to continue working on the balance until the test has passed. Choose from 1 X, 2 or 3 Attempts and Until Passed . Until Passed allows unlimited number of attempts.  Note: When GWP History is enabled, only the last result and the number of attempts are recorded.

"Instructions if Failure": Defines instructions for the user that will be displayed after a test fails. This setting does not depend on the parameter **"Action if Failure"** and appears each time a Test Sequence fails.

Choose between two settings:

"None" X: **The test "Name" has failed.**

"Standard": **The test "Name" has failed.**

The balance is out of your predefined tolerances.

Please contact the person responsible in your company or METTLER TOLEDO Service.

"Code to Unblock": If the system has been blocked because of a failed Test Sequence (due to the "Action if Failure" settings), it can be unblocked again with the help of the Test Sequence specific **"Code to Unblock"**.



Note: If **"Action if Failure" = None** is selected, a failed Test Sequence will **never cause the balance to be blocked**.

Factory setting: Z

"Entry in GWP History": Choose if you want the test result to be stored in the GWP History:

"Yes": Result of the Test Sequence will be saved.

"No" X: Result of the Test Sequence will NOT be saved.



Note: The GWP History is capable of saving 120 test results. Due to this limited number you may find it unnecessary to store the results of Test Sequences **without** quality reference e.g. Test Sequences using the SERVICE Method.

Note: Once the GWP History has reached 120 results, the oldest results stored will be overwritten with the new results.

A complete list of the settings can be printed out by pressing the key while the Test Sequence menu is open.



For easy traceability and to meet documentation requirements, it is recommended that the settings of the **Test Sequence are printed out** after each change – the Version number of the Test Sequence is included in the printout.

3.2.2 Settings of the Parameter "Action if Failure" = Warning

Action if Failure Sensitivity		Setup Version 2
<input type="radio"/>	None	
<input checked="" type="radio"/>	Warning	Define
<input type="radio"/>	Attempts	1
OK		

Warning Sensitivity		Setup Version 2
Warning Message	Standard	
Time Interval	1 h	
Max. Number of Warning	1	
Action after Failure	None	
OK		

"Warning Message": Choose the warning message given to the user after a failed Test Sequence. The dialogue box with the warning also has a Start button which can be used to restart the Test Sequence:

"Standard" X: **The test "Name" has failed. Please perform the test sequence again.**

- "Advanced":** The test "Name" has failed. Please perform the following:
1. Check the weighing parameter settings.
 2. Perform the test sequence again using the function key or directly using the Start button.



Note: To be able to start the Test Sequence using the function key, the relevant Task must already be configured accordingly and the Test Sequence function key enabled.

Note: If the "Start" button is disabled (grayed out), the current user profile has insufficient access rights to begin the procedure.

"Time Interval": Define the length of time in hours until the warning should be given again.
Intervals from 1 up to 1000 hours can be set.

Factory setting: 1

"Max. Number of Warning": Define the maximum number of warnings allowed for this Test Sequence.
If the last warning is reached and the Test Sequence has not yet been successfully executed, the balance will be blocked.

Valid inputs are 1 up to 1000.

Factory setting: 1

"Action after Failure": Allows you to define how the Test Sequence should behave after it has been newly started from the warning dialogue. Choose from the following settings:

"None" X: The Test Sequence will be aborted and then restarted after the sequence of the next warning interval. See also **Max. Number of Warning**.

"Attempts": In contrast to "None", the balance does not go back to warning mode. The test sequence must be successfully executed according to the number of attempts defined here, or else it will block the balance.

The available settings to choose from here are the same **Attempts** settings as described in section 3.2.1.



No further warning messages will be given when the Test Sequence has been successfully executed. If the balance is already blocked, the warning messages will be deactivated by unblocking the system.

3.2.3 The Method

A Method describes the type of test to be performed and forms the core of a Test Sequence. The test weight(s) to be used and the associated tolerances must be defined as part of the Method. There are 8 different Methods available.

Method Sensitivity		Setup Version 2
<input checked="" type="radio"/>	None	
<input type="radio"/>	EC	Define
<input type="radio"/>	RP1	Define
<input type="radio"/>	RPT1	Define
<input type="radio"/>	SE1	Define
<input type="radio"/>	SE2	Define
<input type="radio"/>	SERVICE	Define
<input type="radio"/>	SET1	Define
<input type="radio"/>	SET2	Define
OK		

"None" X:	No method will be selected
"EC":	Method for Eccentricity Test (section 3.2.3.2)
"RP1":	Method for Repeatability Test (section 3.2.3.3)
"RPT1":	Method for Repeatability Test with Tare (section 3.2.3.4)
"SE1":	Method for Sensitivity Test with 1 Testpoint (section 3.2.3.5)
"SE2":	Method for Sensitivity Test with 2 Testpoints (section 3.2.3.6)
"SERVICE":	Method for Service Method (section 3.2.3.7)
"SET1":	Method for Sensitivity Test with Tare and 1 Testpoint (section 3.2.3.8)
"SET2":	Method for Sensitivity Test with Tare and 2 Testpoints (section 3.2.3.9)

3.2.3.1 Defining Weights and Tolerances for a Method

Methods **EC**, **RP1**, **RPT1**, **SE1**, **SE2**, **SET1** and **SET2** require one or more test weights and their associated tolerances to be defined. The process is as follows:

1. Select the test weight for the test
2. Define the test tolerances for the test weight, if applicable
3. Define the result tolerances for the method result

Method Sensitivity		Setup Version 2
<input type="radio"/>	None	
<input checked="" type="radio"/>	EC	Define
<input checked="" type="radio"/>	RP1	Define
<input checked="" type="radio"/>	RPT1	Define
<input checked="" type="radio"/>	SE1	Define
<input checked="" type="radio"/>	SE2	Define
<input type="radio"/>	SERVICE	Define
<input checked="" type="radio"/>	SET1	Define
<input checked="" type="radio"/>	SET2	Define
OK		

Method Name Sensitivity		Setup Version 2
Tare Weight		Define
Test Weight		Define
OK		

Selection that appears are the names of the Test/Adj. weights that you have perviously defined (see section 3.1.1)

C

Test Weight Sensitivity		Setup Version 2
Test/Adj. Weight		Define
Tolerances		Define
OK		

Tol. Test Weight 1 Sensitivity		Setup Version 2
Tolerance T1		0.10 g
Name T1		Warn Limit
Tolerance T2		0.10 g
Name T2		Control Limit
OK		



Warning: It is important to distinguish between the test tolerances used for the individual weight measurements during the Test Sequence and those that are applied to the results at the end (Methods EC, RP1 and RPT1).

1. Select the Test Weights for the Test

On pressing "Test Weight" or "Tare Weight" you can select the desired test weight from the list of previously configured weights. For the Tare Weight select the weight which corresponds to the test weight of the tare container.

2. Define the Tolerances for the Test

Each test weight has two associated tolerances (T1 and T2) which are applied to the weight during the Test Sequence as described below:

"Tolerance T1": Tolerance T1 is used as a warning to the user and should therefore be smaller than T2. If this tolerance is exceeded a warning will be generated but the user can still complete the Test Sequence. A record of the warning is stored in the Test History and will be printed in the report. If you do not want T1 to be defined as part of the Test Sequence it can be turned off by setting it to 100 %.

"Name of Tolerance 1": The name of T1 can be freely defined. **Max 20 characters!**

Factory Setting: Name = "Warn Limit"

"Tolerance T2": If Tolerance T2 is exceeded the Test Sequence will be aborted. The user is given the message that the test has failed. The error is stored in the Test History and will be printed in the report. If you do not want T2 to be defined as part of the Test Sequence, it can be turned off by setting it to 100 %.

"Name of Tolerance 2": The name of T2 can be freely defined. **Max 20 characters!**

Factory Setting: Name = "Control Limit"



Note: The smallest value shown for Tolerances T1 and T2 depends on the type of balance used and carries 1 digit.

3. Define the Tolerances for the Method Result

For the Methods **EC**, **RP1** and **RPT1** two further tolerances are applied to the results generated from the Test Sequence. These two tolerances are defined and apply in the same way as those for the test tolerances as described above.



Note: When using a Method which calculates an end result, it is advisable to turn off Test and Tare Weight Tolerances by setting them to 100 % to allow the full Test Sequence to be executed and the result tolerance (method tolerance) T2 to be applied.

A complete list of the settings can be printed out by pressing the «» key while the Test Sequence menu is open.

3.2.3.2 EC Method for Eccentricity Test

The aim of the EC Method (Eccentricity Test) is to ensure that any deviation due to eccentricity is within the tolerances required by the user's SOP. The result is set equal to the largest of the 4 calculated eccentricities (4-7).

Method Sequence:

1. Zero
2. Load Test Weight (Center)
3. Tare
4. Reposition Test Weight (to Front Left)
5. Reposition Test Weight (to Rear Left)
6. Reposition Test Weight (to Rear Right)
7. Reposition Test Weight (to Front Right)
8. Unload all weights
9. Zero

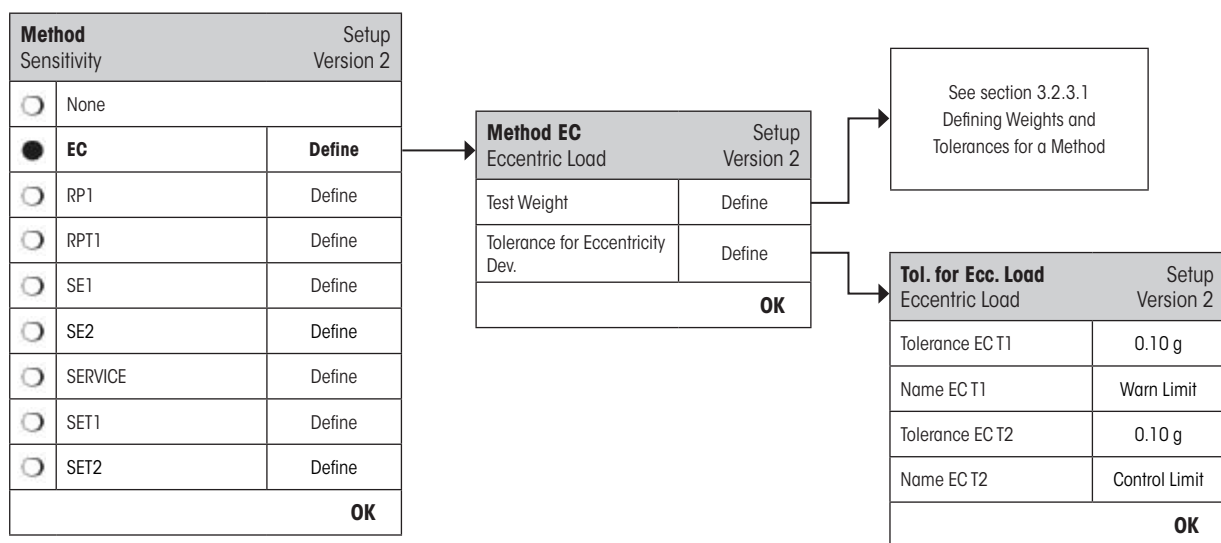

"Test Weight":

A pre-defined test weight and its corresponding test tolerances can be selected here (see section 3.2.3.1).



Note: The tolerances T1 and T2 apply to the individual weight measurements and not to the eccentricity calculation.

Note: If you require the eccentricity test to be fully executed the test weight tolerances should be set to 100 %.

"Tol for Eccentricity Dev":

The EC Method uses two result tolerances (method tolerances) **ECT1** and **ECT2** which are applied to the calculated standard deviation of the Test Sequence and functions in the same way as described for T1 and T2 in section 3.2.3.1. If Tolerance ECT1 is exceeded the Eccentricity Test will Pass with Warning. If Tolerance ECT2 is exceeded the Eccentricity Test will Fail.

A complete list of the settings can be printed out by pressing the  key while the Test Sequence menu is open.

3.2.3.3 RP1 Method for Repeatability Test

The RP1 Method calculates the mean value and standard deviation (symbol **s**) of a measurement series using a single test weight to determine the repeatability of the balance.

Method Sequence:

1. Zero
2. Load Test Weight
3. Unload Test Weight
4. Repeat steps 2 and 3
5. Unload all weights
6. Zero

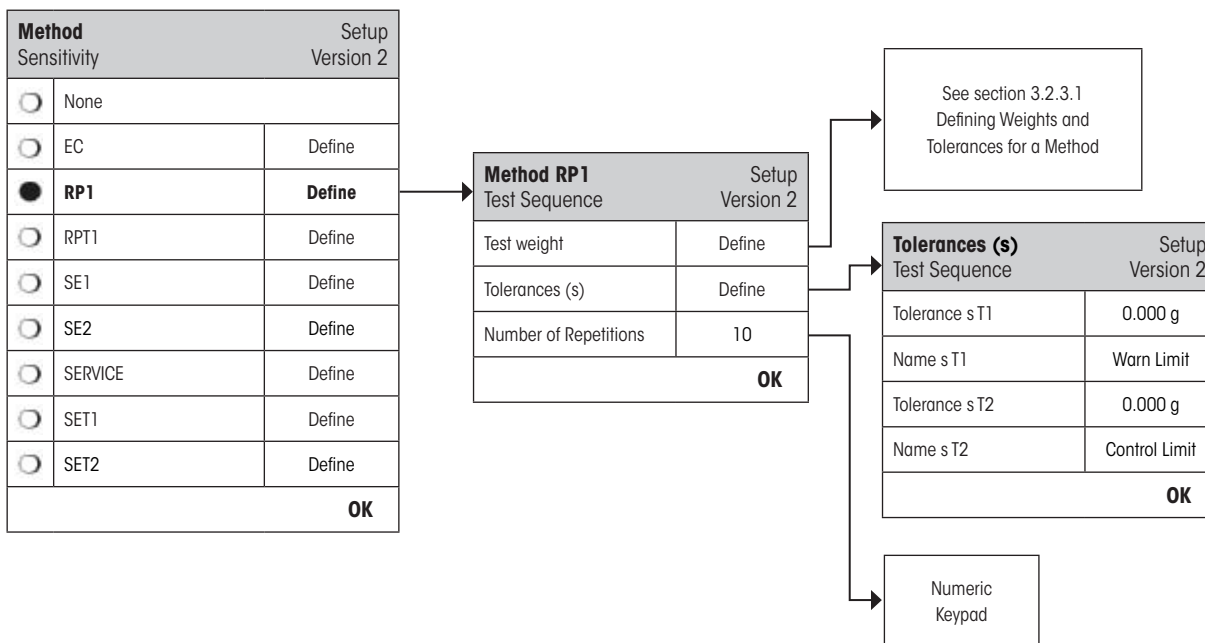

“Test Weight”:

A pre-defined test weight and its corresponding test tolerances can be selected here (see section 3.2.3.1).



Note: The test tolerances of the test weight are valid for every individual weight value, but do not apply to the standard deviation that is to be calculated.

Note: If you require the repeatability test to be fully executed the test weight tolerances should be set to 100 %.

“Tolerances s”:

The RP1 Method uses two result tolerances (method tolerances) **sT1** and **sT2** which are applied to the calculated standard deviation of the Test Sequence and functions in the same way as described for T1 and T2 in section 3.2.3.1. If Tolerance s T1 is exceeded, the Repeatability Test will pass with warning. If Tolerance s T2 is exceeded, the Repeatability Test will fail.

“Number of Repetitions”:

Define the number of weight measurements in the series.

Valid range of input: 2 - 15

Factory Setting: 10

A complete list of the settings can be printed out by pressing the key while the Test Sequence menu is open.

3.2.3.4 RPT1 Method for Repeatability Test with Tare

The RPT1 Method calculates the mean value and standard deviation (symbol **s**) of a measurement series using two test weights to determine the repeatability of the balance. In contrast to the RP1 Method an extra test weight is used to simulate the use of a tare container.

Method Sequence:

1. Zero
2. Load Tare Weight
3. Tare
4. Load Test Weight
5. Unload Test Weight
6. Repeat steps 4 and 5
7. Unload all weights
8. Zero

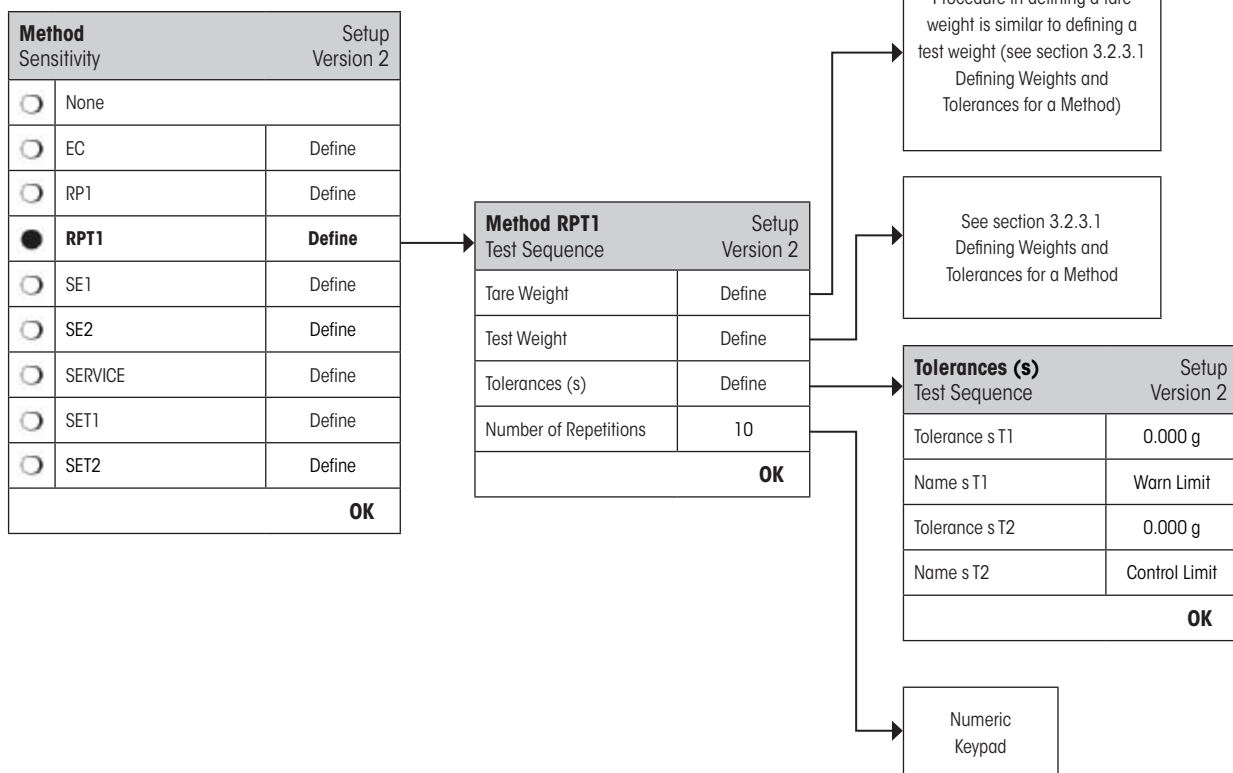

"Tare Weight":

Select the test weight which represents the weight of the tare container from the list of previously configured weights and define the weight tolerances as described in section 3.2.3.1.



Note: It is recommended to set the tare weight tolerances to 100 %.

"Test Weight":

A pre-defined test weight and its corresponding test tolerances can be selected here (see section 3.2.3.1).



Note: The test tolerances of the test weight are valid for every individual weight value, but do not apply to the standard deviation that is to be calculated.

Note: If you require the repeatability test to be fully executed the test weight tolerances should be set to 100 %.

“Tolerances s”: The RPT1 Method uses two result tolerances (method tolerances) sT1 and sT2 which are applied to the calculated standard deviation of the Test Sequence. It functions in the same way as described for T1 and T2 in section 3.2.3.1. If Tolerance sT1 is exceeded, the Repeatability Test will pass with warning. If Tolerance sT2 is exceeded, the Repeatability Test will fail.

“Number of Repetitions”: Define the number of weight measurements in the series.
Valid range of input: 2 - 15
Factory Setting: 10

A complete list of the settings can be printed out by pressing the «» key while the Test Sequence menu is open.

3.2.3.5 SE1 Method for Sensitivity Test with 1 Testpoint

The SE1 Method tests the sensitivity of the balance using a single test weight.

Method Sequence:

1. Zero
2. Load Test Weight
3. Unload all weights
4. Zero

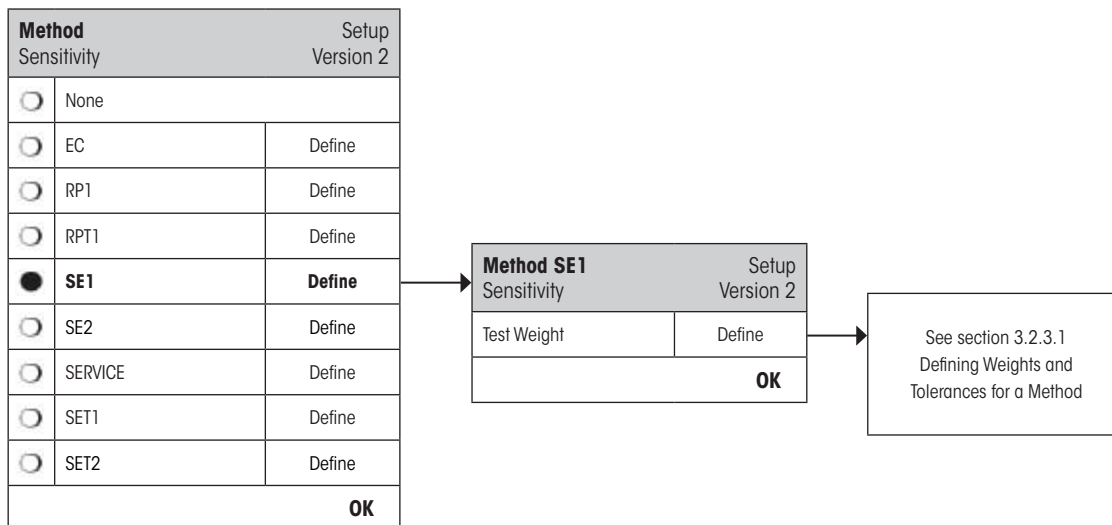

“Test Weight”: Select the weight to be used for the test from the list of previously configured weights and define the test tolerances as described in section 3.2.3.1.



Note: In this Method the test tolerances apply to the Sensitivity Test.

A complete list of the settings can be printed out by pressing the «» key while the Test Sequence menu is open.

3.2.3.6 SE2 Method for Sensitivity Test with 2 Testpoints

In contrast to SE1 Method, SE2 Method tests the sensitivity of the balance using two test weights.

Method Sequence:

1. Zero
2. Load Test Weight 1
3. Unload Test Weight 1
4. Zero
5. Load Test Weight 2
6. Unload all weights
7. Zero

Method	Setup
Sensitivity	Version 2
<input type="radio"/> None	
<input type="radio"/> EC	Define
<input type="radio"/> RP1	Define
<input type="radio"/> RPT1	Define
<input type="radio"/> SE1	Define
<input checked="" type="radio"/> SE2	Define
<input type="radio"/> SERVICE	Define
<input type="radio"/> SET1	Define
<input type="radio"/> SET2	Define
OK	

Method	Setup
SE2	Version 2
Sensitivity	
Test Weight 1	Define
Test Weight 2	Define
OK	

See section 3.2.3.1
Defining Weights and
Tolerances for a Method

"Test Weight 1":

Select the first weight to be used for the test from the list of previously configured weights and define the test tolerances as described in section 3.2.3.1.



Note: In this Method the test tolerances apply to the Sensitivity Test.

"Test Weight 2":

Select the second weight to be used for the test from the list of previously configured weights and define the test tolerances as described in section 3.2.3.1.



Note: In this Method the test tolerances apply to the Sensitivity Test.

A complete list of the settings can be printed out by pressing the «» key while the Test Sequence menu is open.

3.2.3.7 SERVICE Method for Reminder / Early Notification

The SERVICE Method is a specialized Method which does not require the use of a test weight. It is usually set up to run in the background to regularly check various dates stored in the balance and will often terminate itself without any interaction from the user or without displaying a dialogue. E.g. it is typically employed as a reminder for the next Service date or MinWeigh date – the date will be checked regularly but the user will only receive a dialogue when the defined job becomes due. The SERVICE Method can also be used to provide advanced notification of when a test is due with the Early Warning Alert.

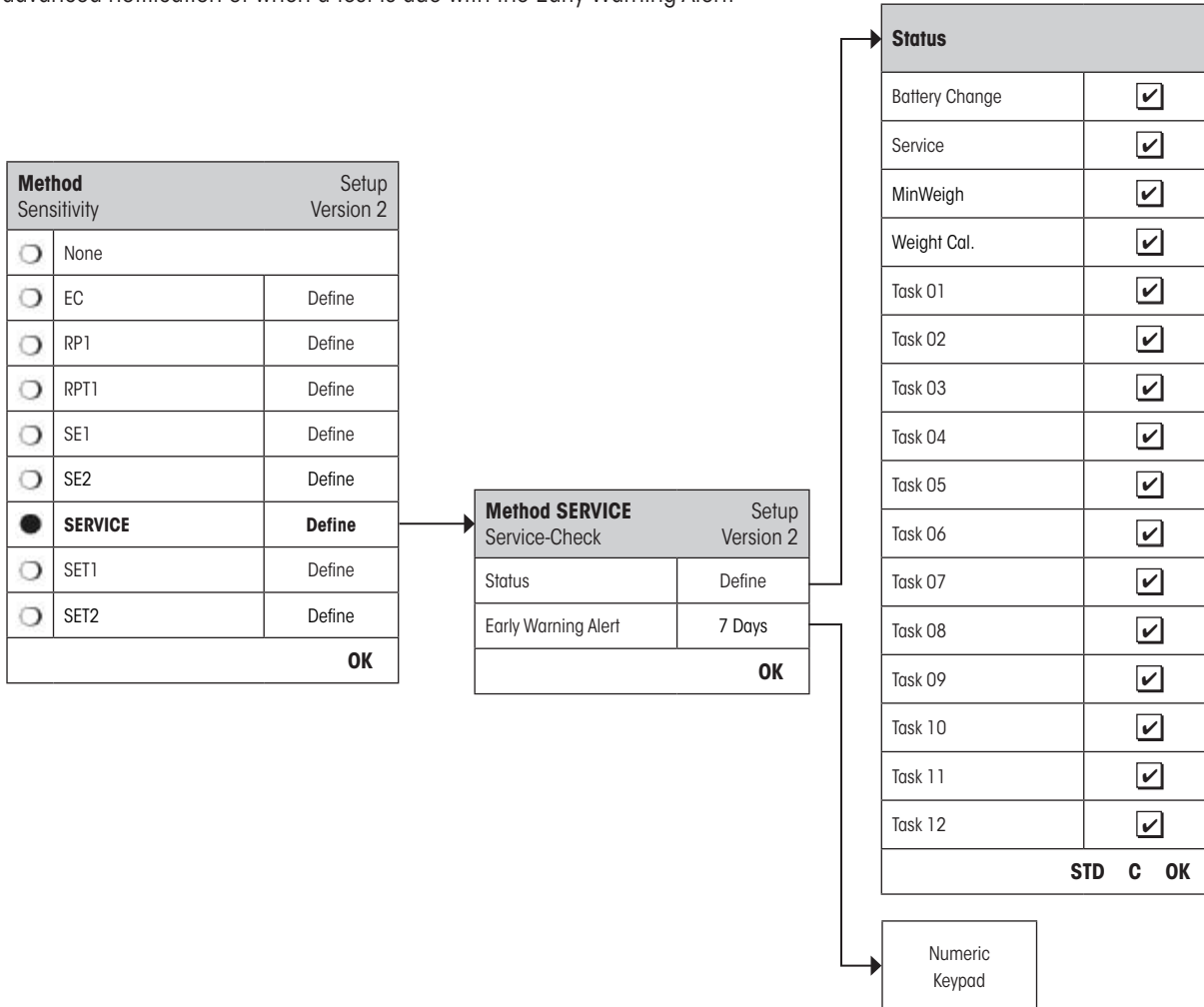

Note: In order for this Test Sequence to terminate without interaction from the user the "Preparation Instructions" must be set to "None" (see section 3.2.1).

"Status":

Multiple selections are possible from all available options to define which dates should be monitored by this Test Sequence. The user will receive a message when the job is due. The dates of the following are available to choose from:

- "Battery Change": Date of the next battery change
- "Service": Date of the next Service
- "MinWeigh": Date of the next MinWeigh determination
- "Weight Cal.": Date of the "Next Calibration Date" for ALL test weights
- "Task 01 - 12": Date of the "Next Call Date" of the Task
- Factory Setting:** No item is selected

"Early Warning Alert":

Define how early the warning should appear. E.g. set a reminder for 7 days before the battery is due to be changed. If the test has passed within the Early Warning period, the test will be recorded as "Passed with Warning". If the Early Warning period has elapsed, the test will fail. The "Instructions if Failure" can provide further instructions to the user (see section 3.2.1).

Valid range of input: 1 - 365 days

Factory Setting: 7 days



Note: Using the Early Warning Alert as a reminder for another Task to be performed requires the creation of two Tasks – one for the original Test Sequence and one for the reminder.

Note: Multiple dates can be simultaneously checked with the Service Method (see multiple selections in "Status"). However, the same Early Warning period is valid for all scheduled dates. If varying Early Warning periods are required, several Service Methods must be defined.

Note: The reminder Task must be set up to check the dates on a regular basis; choose the frequency of the check in relation to the Early Warning period and the frequency of the Test Sequence to be performed.

For information on configuring Tasks, see section 3.3.

A complete list of the settings can be printed out by pressing the «» key while the Test Sequence menu is open.

The SERVICE Method can also be used for the sole purpose of displaying the "Preparation Instructions" e.g. so the user can be informed to level the balance each day. In this special case, set the "Preparation Instructions" to "Standard" in the Test Sequence settings and ensure NO items in the "Method Status" are selected.

3.2.3.8 SET1 Method for Sensitivity Test with Tare and 1 Testpoint

The SET1 Method tests the sensitivity of the balance using two test weights. The first test weight is used to simulate the use of a tare container.

Method Sequence:

1. Zero
2. Load Tare Weight
3. Tare
4. Load Test Weight
5. Unload all weights
6. Zero

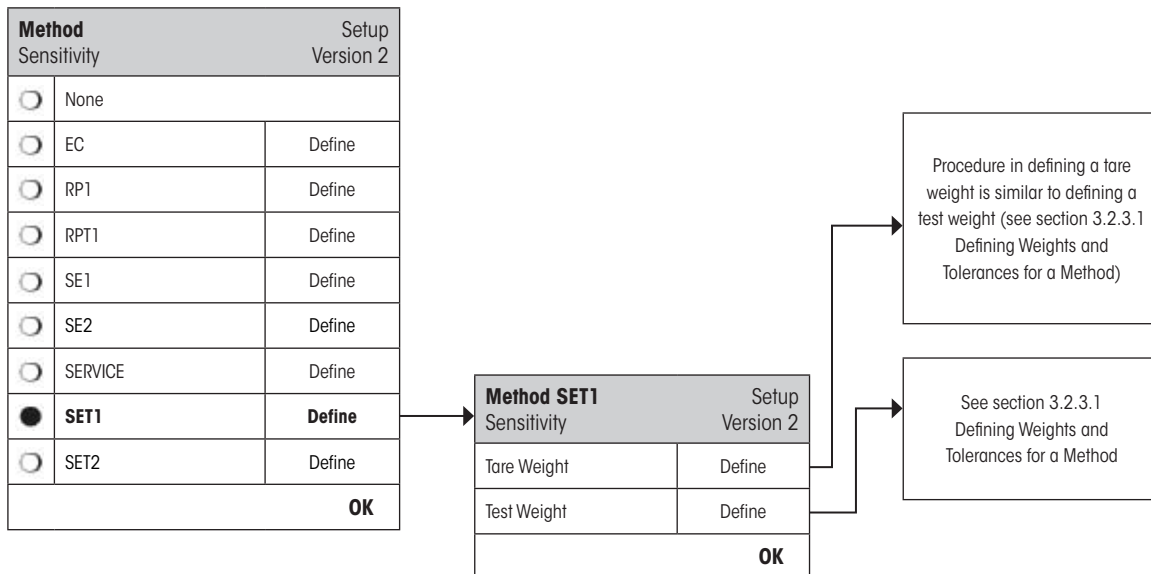

“Tare Weight”:

Select the test weight which represents the weight of the tare container from the list of previously configured weights and define the weight tolerances as described in section 3.2.3.1.



Note: The system will first check if the tare weight is within the pre-defined weight tolerances. While the tare weight is left on the balance, the test weight is used to determine the Sensitivity.

Note: It is recommended to set the tare weight tolerances to 100 %.

“Test Weight”:

A pre-defined test weight and its corresponding test tolerances can be selected here (see section 3.2.3.1).



Note: In this Method the test tolerances apply to the Sensitivity Test.

A complete list of the settings can be printed out by pressing the «» key while the Test Sequence menu is open.

3.2.3.9 SET2 Method for Sensitivity Test with Tare and 2 Testpoints

In contrast to SET1 Method, SET2 Method tests the sensitivity of the balance using three test weights. The second test weight (Tare Weight) is used to simulate the use of a tare container.

Method Sequence:

1. Zero
2. Load Test Weight 1
3. Unload Test Weight 1
4. Zero
5. Load Tare Weight
6. Load Test Weight 2
7. Unload all weights
8. Zero

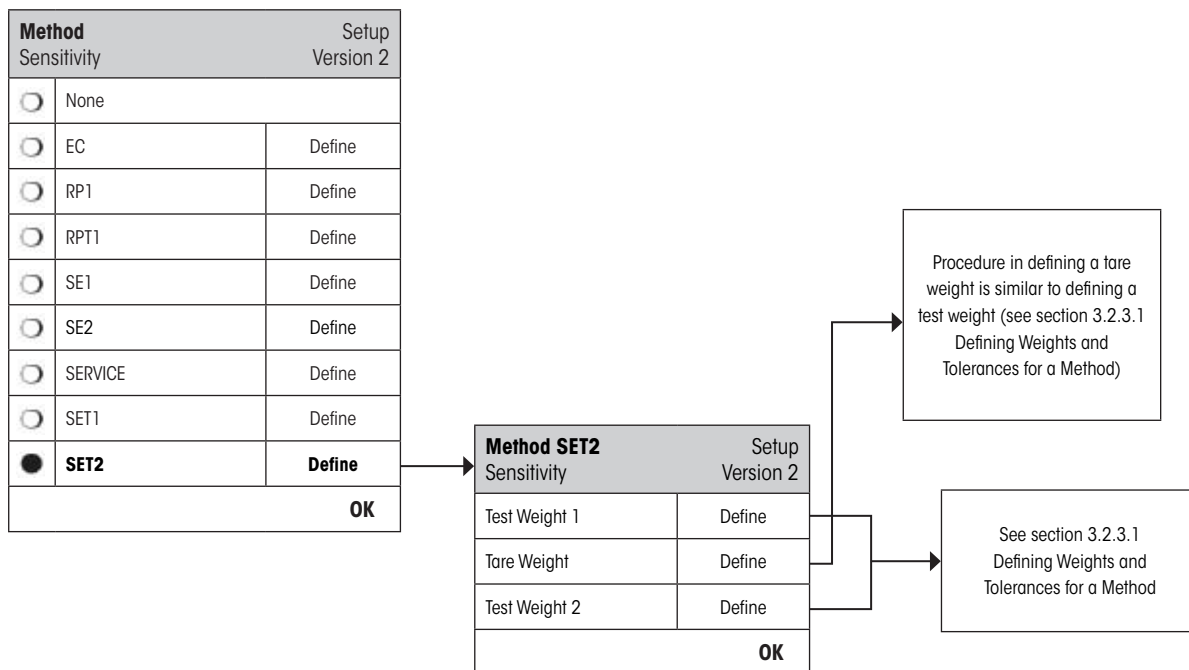

"Test Weights 1 and 2": Same function as Test Weight in the previous section 3.2.3.8 - SET1 Method.

"Tare Weight": Same function as Tare Weight in the previous section 3.2.3.8 - SET1 Method.

A complete list of the settings can be printed out by pressing the «» key while the Test Sequence menu is open.

3.3 Tasks

Test Sequences define which test is to be performed and with which test weight(s). Tasks define **when** the Test Sequence should be executed and how it should be **started**. Before a Task can be defined, the Test Sequence and the necessary weights must first be defined. Up to 12 Tasks can be defined. When a Test Sequence is assigned to a Task, its name appears in the Task List as shown in the example below.

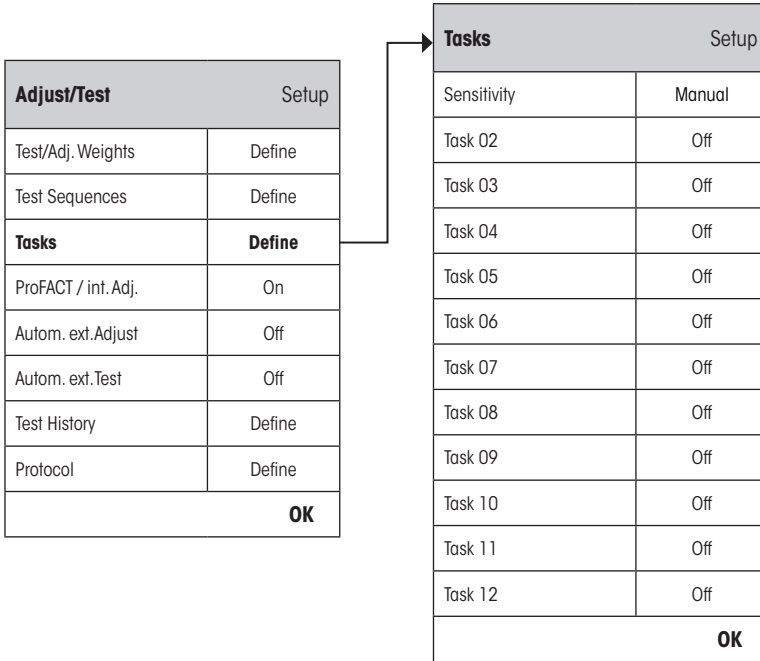

A complete list of the 12 tasks can be printed out by pressing the «» key while the task list is open.

3.3.1 Task State

The task can be switched on or off in the task status window as illustrated below. Tasks that are switched off will be ignored by the system. Tasks which are switched on may be modified or updated.

Tasks		Setup
Sensitivity		Manual
Task 02		Off
Task 03		Off
Task 04		Off
Task 05		Off
Task 06		Off
Task 07		Off
Task 08		Off
Task 09		Off
Task 10		Off
Task 11		Off
Task 12		Off
OK		

Task State		Setup
Task	<input type="radio"/> Off	
	<input checked="" type="radio"/> On	Manual
OK		

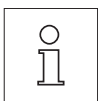

Note: The date when the Test Sequence is scheduled to take place will be recalculated as soon as the Task State is saved by pressing "OK". The due date of the next subsequent occurrence is calculated at the end of each executed Test Sequence.

A complete list of the settings can be printed out by pressing the «☰» key while the Task State menu is open.

3.3.2 Assigning a Test Sequence to the Task

An existing Test Sequence can be assigned to the Task. On selecting "Test Sequence", the user can select from a list of previously configured Test Sequences.

Task State		Setup
Task	<input type="radio"/> Off	
	<input checked="" type="radio"/> On	Manual
OK		

Task #		Setup
Test Sequence		Define
Starting Method		Manual
Defined Days		Define
Defined Users		Define
OK		

Selection that appears are the names of the test sequences that you have previously defined in the Test Routine List (see section 3.2.1)
C

3.3.3 Starting Method

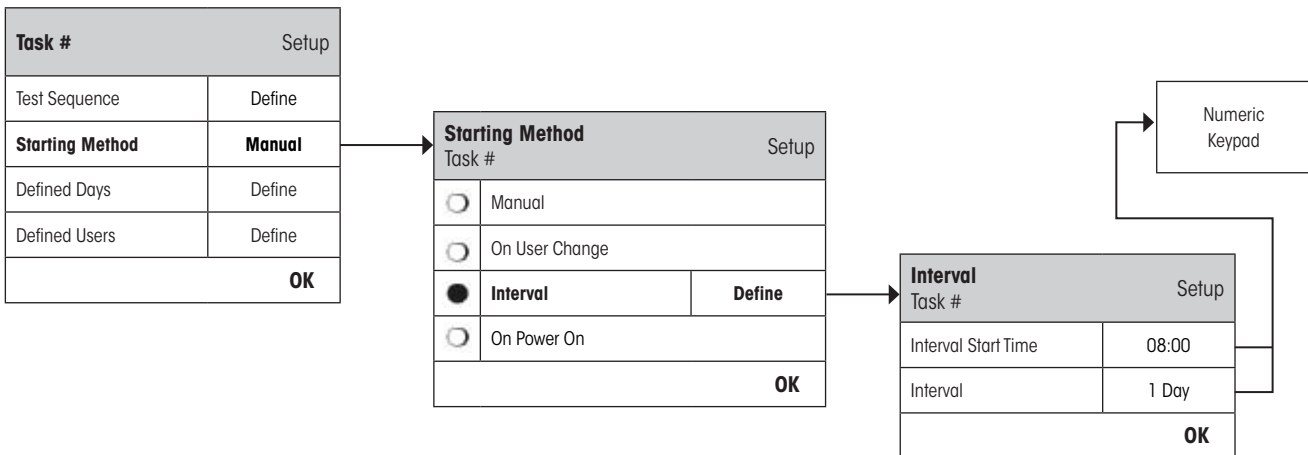

The Test Sequence defined in the Task can be started in 4 different ways. Choose from:

"Manual":

The Test Sequence can be started manually at any time by pressing the Test Sequence Function Key on the main balance display.



Note: In the Task settings "Defined Days", the day of the week when the Test Sequence can be started is defined.

Note: In the Task settings "Defined Users", the users who are permitted to start the Test Sequence are defined.

See "Defined Days" and "Defined Users" for further information.

"On User Change":

When the user profile is changed, the balance will call for the Test Sequence that is defined in the Task to be executed.



Note: In the Task settings "Defined Days", if the day is not activated when the user profile is changed, then the change will take place without the call for the test.

Note: In the Task settings "Defined Users", if the new user profile is not in the Defined Users, then the user change will take place without the call for the test.

See "Defined Days" and "Defined Users" for further information.

"Interval":

Defines the times at which the balance automatically prompts for the Test Sequence to be performed.

"Interval Start Time"

The time of day when the test should be done. **Range 0:00 until 23:59.**



Note: In order to ensure that a test is performed before actual work starts on the balance, the Start Time is often set earlier than actually required e.g. Start Time is set to 7.00 when work usually begins at 8.00.



Note: If you change the date/time of the terminal, it is recommended to reset the previously calculated next scheduled call-up of the interval tasks. Do the following steps:

1. Go to the corresponding task menu of the interval task.
2. Switch off the task.
3. Close the menu with "OK" to save the changes (the next scheduled task will be erased).
4. Go back to the task menu that had just been switched off.
5. Switch on the task again.
6. Close the menu with "OK" to save the changes (the next scheduled task will be recalculated and the task is active again).



Note: Repeat these steps for all your interval tasks.

"Interval"

The time, in days, between each test. **Range is 1 to 720 days.**



Note: If a test is not executed at the scheduled time, for example because it occurred on a holiday, it will remain pending. If it remains pending until the next call to perform the test, it is only necessary to carry out the test ONCE.

Example: A daily task needs to be executed only once on a Monday even if the same task is pending from the previous Saturday and Sunday.

"On Power On":

If this is activated, the Test Sequence will be started **as soon as the balance is plugged to a power outlet**. This is especially useful, if the balance has been unplugged from its power supply or if a power outage occurs.

3.3.4 Defined Days

Define the days of the week on which the Task may be performed. Regardless of the Starting Method used, the Task can only be executed on the selected days.

Task #		Setup	
Test Sequence		Define	
Starting Method		Manual	
Defined Days		Define	
Defined Users		Define	
OK			

Defined Days			
Monday	<input checked="" type="checkbox"/>	Friday	<input checked="" type="checkbox"/>
Tuesday	<input checked="" type="checkbox"/>	Saturday	<input checked="" type="checkbox"/>
Wednesday	<input checked="" type="checkbox"/>	Sunday	<input checked="" type="checkbox"/>
Thursday	<input checked="" type="checkbox"/>		
STD C OK			

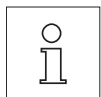

Note: Test Sequences whose Starting Method is defined as "Manual" will appear in the test selection list only on the Defined Days selected here.

Note: Test Sequences whose Starting Method is defined as "On User Change" will be called up only on the Defined Days selected here.

Note: Test Sequences whose Starting Method is defined with an "Interval" will be called up only on the Defined Days selected here. If the day when the Test Sequence becomes due is not defined, the Test Sequence will be deferred until the next valid day.

Important: Warning dialogues relating to failed tests will still be displayed on days that are not defined! Provided that the current User is defined (see section 3.3.5 below), the Test Sequence may be started directly from the warning dialogue.

3.3.5 Defined Users

Define which User Profiles have the right to execute the Task. Regardless of the Starting Method used, the Task can only be executed by the selected Users.

Task #	Setup
Test Sequence	Define
Starting Method	Manual
Defined Days	Define
Defined Users	Define
OK	

Defined Users			
Home	<input checked="" type="checkbox"/>	User 4	<input checked="" type="checkbox"/>
User 1	<input checked="" type="checkbox"/>	User 5	<input checked="" type="checkbox"/>
User 2	<input checked="" type="checkbox"/>	User 6	<input checked="" type="checkbox"/>
User 3	<input checked="" type="checkbox"/>	User 7	<input checked="" type="checkbox"/>
STD C OK			



Note: Test Sequences whose Starting Method is defined as "Manual" will appear in the test selection list only for the Defined Users selected here.

Note: Test Sequences whose Starting Method is defined as "On User Change" will be called up only when the new user belongs to the Defined Users selected here.

Note: Test Sequences whose Starting Method is defined with an "Test Interval" will be called up only when the user belongs to the Defined Users selected here. If the current user is not defined, the Test Sequence will be deferred until a Defined User logs in.

Important: All users will receive a warning of a failed or aborted test. However, the Warning Message is only generated for Test Sequences configured to include a warning in "Action if Failure" (see section 3.2.2).

3.4 ProFACT / int. Adj.

ProFACT is **Professional Fully Automatic Calibration Technology** and provides fully automatic internal balance adjustment using an internal weight based on preselected time and/or temperature criteria.



Note: For certified balances (Accuracy Class II according OIML) ProFACT / int. Adj. is always active i.e. it is not possible to switch ProFACT off.

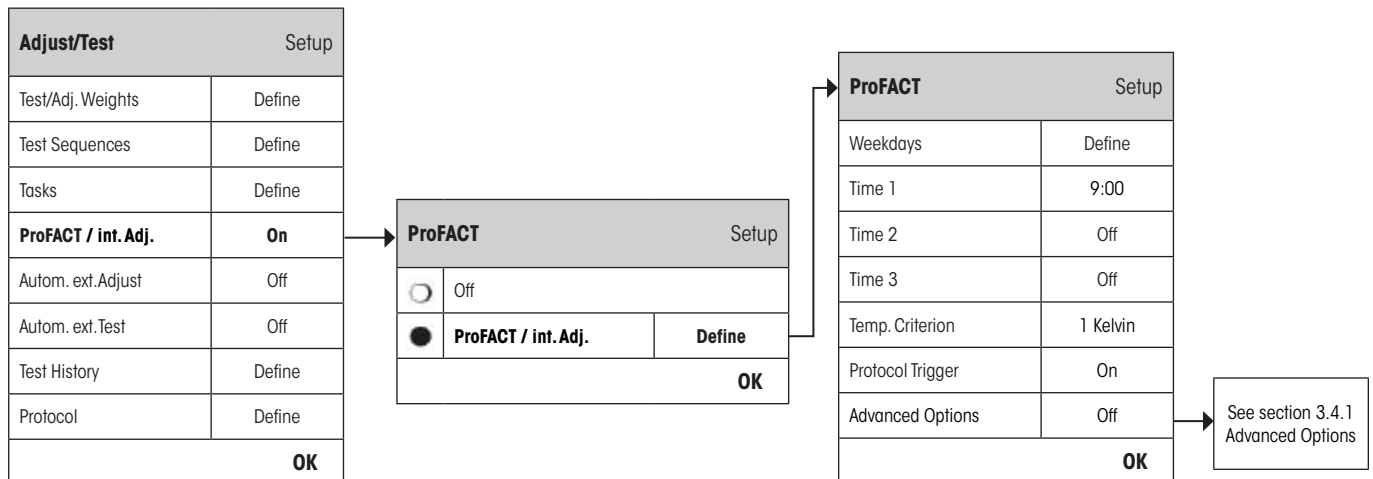

The following settings are available:

- “**Off**” : ProFACT / int. Adj. fully automatic adjustment is **switched off**.
 “**ProFACT / int. Adj.**” : ProFACT / int. Adj. fully automatic adjustment is **switched on (Factory Setting)**.

The behavior of the ProFACT adjustment function can be defined using the “**Define**” button.

“**Weekdays**” : Define the days on which fully automatic adjustment should be carried out. If you do not wish to have time-controlled adjustment, deactivate all days.
Factory setting: All days activated

“**Time 1**” ... “**Time 3**” : For the selected days, you can specify up to 3 different times for the automatic adjustment to take place.
Factory setting: “Time 1” = 9:00, “Time 2” and “Time 3” = “Off”

“**Temp. Criterion**” : Define the change in ambient temperature which will trigger the automatic adjustment. If “Off” is selected, automatic adjustment based on the temperature criterion will not take place.
Factory setting:
 Precision Balances: Model-dependent
 Analytical- and Micro-balances: “2 Kelvin”

“**Protocol Trigger**” : If “**On**” is selected a record will automatically be printed out whenever the balance undergoes an automatic adjustment. If “Off” is selected, no printout will be made.
Factory setting: “On”

“Advanced Options”: With **“Advanced Options”**, you are able to further expand the sequence of the ProFACT and the internal adjustments using internal tests. Details are found in the following section 3.4.1.

3.4.1 Advanced Options

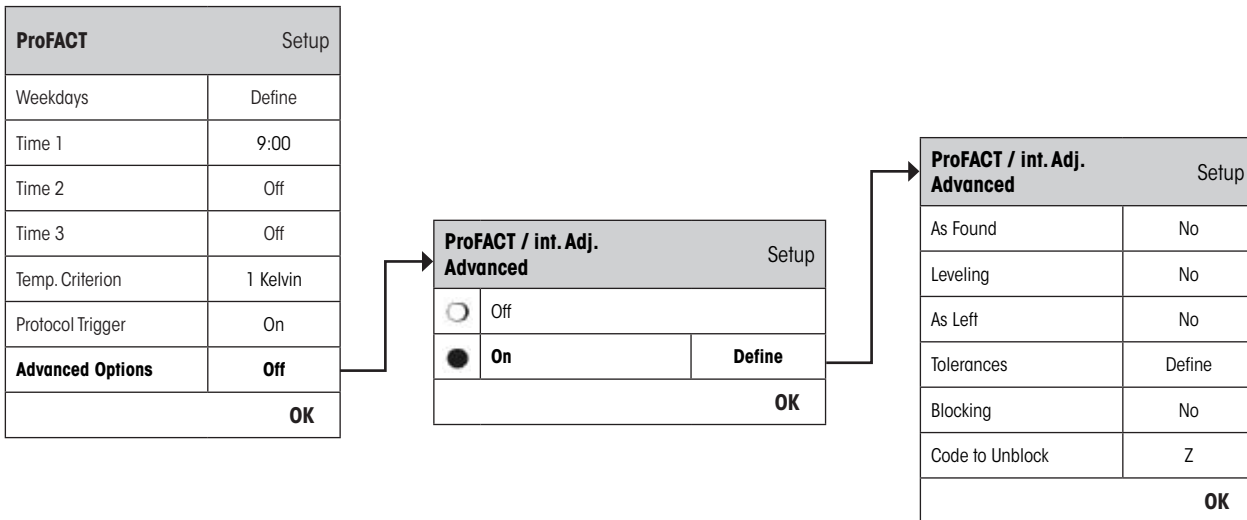

By turning on the Advanced Options, you can customize the adjustment process according to your requirements.

Factory setting: “Off”

Choose between the following settings:

“As Found”: When the adjustment process is started, an internal test will be executed as an initial test in order to obtain the actual weight. The test will automatically be started when the adjustment process is called up.

Factory setting: “No”

“Leveling”: If this option is activated, the level of the balance has to be checked.



Note: If the balance does not have a level sensor or is out of level, the system will prompt you to level the balance.

Factory setting: “No”

“As Left”: If this option is activated, a new internal test will be executed as a final test.

Factory setting: “No”

“Tolerances”: Here, you can define tolerances that were applied in **“As Found”** (initial test) and **“As Left”** (final test). See also **“Define the Tolerances for the Test”** found in section 3.2.3.1

“Blocking”: With this option, you can define if the balance should be blocked when the Tolerance T2 in **“As Found”** or **“As Left”** is violated. After the balance has been blocked, it can only be used again when the corresponding code to unblock is entered.

Factory setting: “No”

"Code to Unblock": Here, you can define the code to be used for unblocking a blocked balance by an **"As Found-**", adjustment or **"As Left-**" failure.
Factory setting: "Z"

3.5 Automatic Adjustment Using an External Test Weight

If you are working with an external test weight, this setting can be used to define the days and time when the balance should provide an adjustment reminder. Further information on the (automatic) adjustment process using an external test/adjustment weight can be found in section 5.4.2 of the **Operating Instructions – Part 2**.

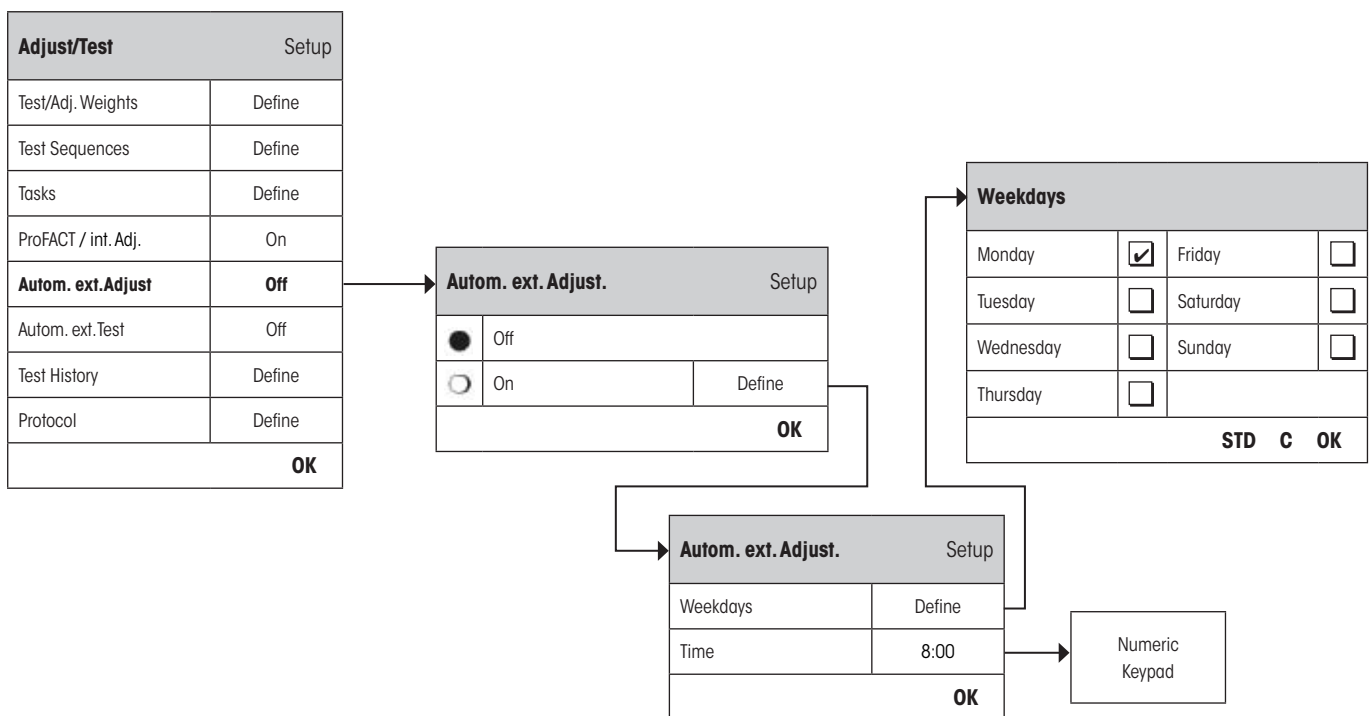

The behavior of the automatic external adjustment function can be specified using the **"Define"** button. The Weekdays and the Time can be defined in the same way as for ProFACT except only one time per day is available.

Factory Setting: Automatic external adjustment function switched off ("Off").

"Weekdays": Define the days on which the adjustment should be carried out.
Factory Setting: Monday

"Time": For the selected days, you can specify the time when the automatic adjustment should take place.
Factory setting: 8:00

3.6 Automatic Adjustment Testing Using an External Test Weight

If you want to test the adjustments using an external test weight, this setting can be used to define the days and time when the balance should provide the test reminder. Further information on the (automatic) adjustment process using an external test weight can be found in section 5.4.4 of the **Operating Instructions – Part 2**.

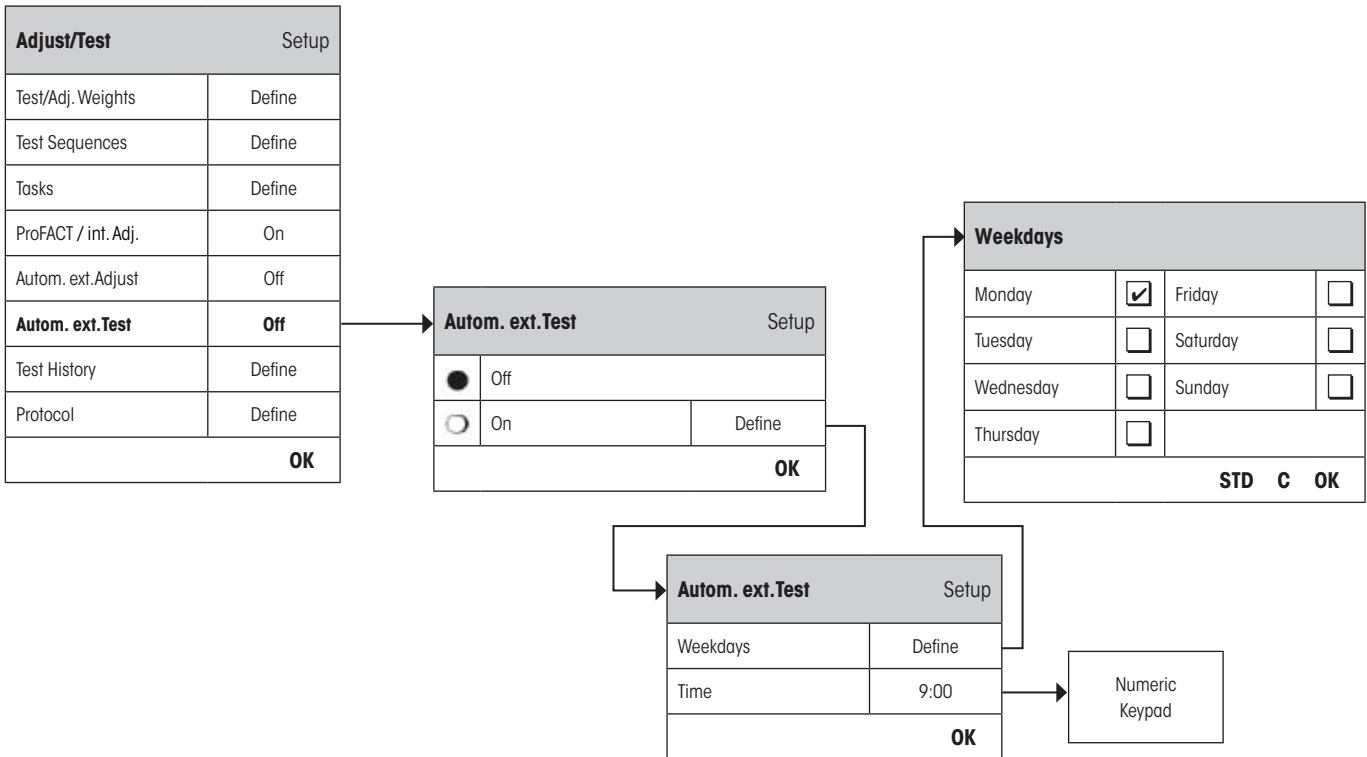

The behavior of the automatic external test function can be specified using the **"Define"** button. The same setting options are available as for defining automatic adjustment using an external test weight (section 3.5).

Factory Setting: Automatic external adjustment function switched off ("Off").

"Weekdays": Define the days on which the adjustment test should be carried out.
Factory Setting: Monday

"Time": For the selected days, you can specify the time when the adjustment test should take place.
Factory setting: 9:00

3.7 Test History

The balance **always** records **all** test operations that have been made and saves them in a memory which is specially protected against power failure. The options in the Test History allow you to define which results you want to view and/or print out for documentation purposes.

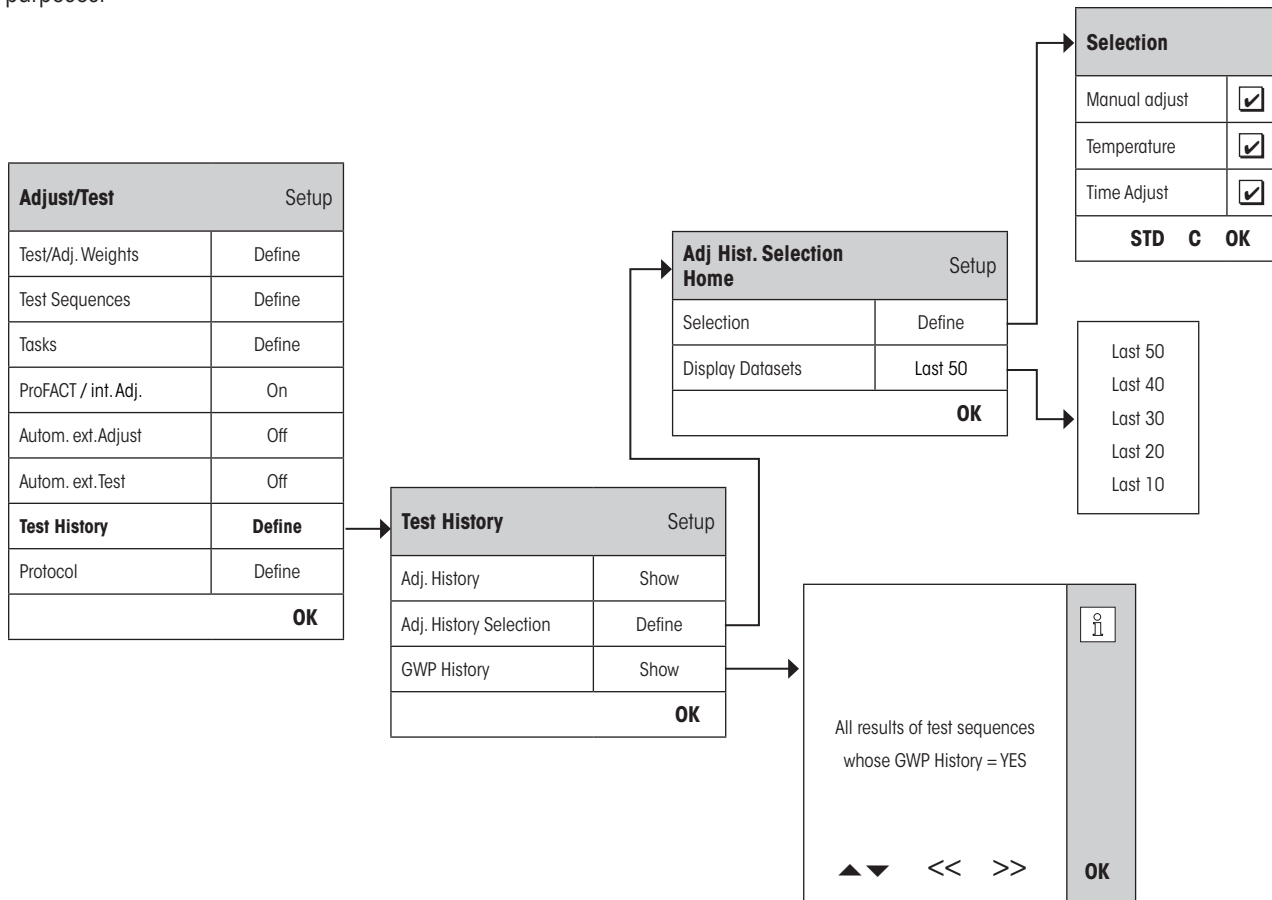

“Adj. History”:

When the **“Show”** button is pressed, a window appears with a list of the adjustments made. Although the balance permanently records all adjustments made, the list displays only those adjustments that have been selected for display in the **“Adj. History Selection”** below. Specific data is displayed for every adjustment: date and time, type of adjustment, temperature, leveling. The entire list can be printed out by pressing the «» key.

“Adj. History Selection”:

Select the adjustments you want to have displayed in the **“Adj. History”** above. You can selectively shorten the list (and hence any printout) and therefore arrange it more clearly. Select from **Manual, Temperature** and **Time controlled adjustments**.



Note: The balance records ALL adjustment operations. The settings in this menu determine which of those operations are displayed on the list.

Factory setting: “Manual Adjust”, “Temperature”, “Time Adjust” activated

"GWP History":

When the **"Show"** button is pressed, a window appears with a list of the results from the Test Sequences. Use the "▼" and "▲" buttons to scroll between pages and the ">>" and "<<" buttons to move between the individual records. The displayed entries can be printed out by pressing the «☰» key. The GWP History can store up to 120 entries.

Test results will only appear in the history file if enter into **GWP History is set to "Yes"**.

Note: If the memory is full (**120 records for GWP History**), the oldest operation will be automatically deleted and overwritten with a new record. You should therefore ensure that you print out and archive the list as required by your laboratory to meet documentation standards and provide full traceability of all tests and adjustments made.

3.8 Protocol – defining the Adjustment and Test Reports

On selection of **"Protocol"** you can define the information you wish to be included when printing out the Adjustment and Test Reports.

Adjust/Test	Setup
Test/Adj. Weights	Define
Test Sequences	Define
Tasks	Define
ProFACT / int. Adj.	On
Autom. ext. Adjust	Off
Autom. ext. Test	Off
Test History	Define
Protocol	Define
OK	

Adjustment and test protocol selection			
Date/Time	<input checked="" type="checkbox"/>	Certificate No.	<input type="checkbox"/>
User	<input checked="" type="checkbox"/>	Temperature	<input type="checkbox"/>
Balance Type	<input checked="" type="checkbox"/>	Nominal Weight	<input checked="" type="checkbox"/>
SNR	<input checked="" type="checkbox"/>	Actual Weight	<input checked="" type="checkbox"/>
SW-Version	<input type="checkbox"/>	Diff.	<input checked="" type="checkbox"/>
Balance ID	<input type="checkbox"/>	Levelcontrol	<input type="checkbox"/>
Weight ID	<input type="checkbox"/>	Signature	<input checked="" type="checkbox"/>
STD C OK			

Sample printout of a test using an external test weight (all printout options activated):

```

---- External test ----
25.Feb 2010           16:02

METTLER TOLEDO
User Name             Home

Balance Type          XP504
WeighBridge SNR:
                      1234567890
Terminal SNR: 1234567890
SW WeighBridge        4.xx
SW Terminal           5.xx
Balance ID            LAB-1/4
Weight ID             ETW-500/1
Certificate No.       MT-223/3

Temperature           21.2 °C
Nominal                500.0000 g
Actual                 500.0005 g
Diff.                  0.0005 g

Balance is levelled

Test done

Signature
.....
-----
    
```

Select the box to have the relevant information included i.e. when a box is ticked, the information will be printed. **"STD"** restores the factory default settings. **"OK"** saves your modifications. **"C"** exits the menu without saving. The following record information can be included in the report:

"Date/Time" :	The date and time of the adjustment are printed in the defined date and time format. Date and Time settings can be found in section 3.6 of the Operating Instructions – Part 2 for XP Balances .
"User" :	The name of the user profile which was active when the adjustment was made (not for automatic ProFACT adjustment).
"Balance Type" :	This information describes the weighing platform and the terminal and cannot be changed by the user.
"SNR" :	The serial numbers of both the terminal and the weighing platform. This information cannot be changed by the user.
"SW-Version" :	Two numbers for the balance firmware, one for the terminal and one for the weighing platform.
"Balance ID" :	The identification number of the balance. Balance Information Settings can be found in section 3.4 of the Operating Instructions – Part 2 for XP Balances .
"Weight ID" :	The identification number of the external test weight used (section 3.1.1).
"Certificate No." :	The number of the certificate relating to the external test weight used (section 3.1.1).
"Temperature" :	Temperature at the time of the adjustment or tests.
"Nominal Weight" :	The actual weight of the external test weight used for the adjustment/test (section 3.1.1).
"Actual Weight" :	The actual weight recorded of the external test weight (only when testing using an external test weight).
"Difference" :	The difference between the nominal weight and the actual weight (only when testing using an external test weight).
"Levelcontrol" :	States whether the balance is leveled correctly.
"Signature" :	An additional line is printed for signing the record.
Factory setting:	"Date/Time", "User", "Balance Type", "SNR" (serial number), "Nominal Weight", "Actual Weight", "Difference" and "Signature" are activated.

4 Glossary - GWP Functions

The following are technical terms and its definitions used in this manual.

Actual Value	Specified value on the Weight Certificate of an external weight. Independent of the balance model.
Actual Weight	The actual weight recorded of the external weight.
Adjustment	Setting of sensitivity on the balance. This requires at least a reference weight that is placed on the balance manually or by a mechanically-driven device. This will be weighed and the obtained value will be saved. The sensitivity of the balance will subsequently be corrected in order to obtain the required measurement.
Adjustment Weight	External weight for adjustment.
Calibration	Checking of external weight and issuance of a certificate thereafter.
Control Limit	Tolerance of a process relative to its target value. Violation of the tolerance is an infringement of the quality requirements, and therefore requires a correction of the process.
Corner Load Deviation	Deviation of weight value, caused by putting load not in the center of the platform.
Corner Load Test	The aim of the EC Method (Eccentricity Test) is to ensure that any deviation due to eccentricity is within the tolerances required by the user's SOP. The result is set equal to the largest of the 4 calculated eccentricities.
External Adjustment Weight	External weight for adjustment.
External Test Weight	External weight used for testing of adjustment.
External Weight	Retractable external adjustment or test weight.
GWPBase™	Service that gives you a personalized document containing precise recommendations for routine testing of your balance: <ul style="list-style-type: none"> • How to test your balance and when (how often) • Which weights should be used • What tolerances are appropriate
GWPExcellence™	Collection of embedded safety functions for XS/XP Balances. The balance actively supports your routine test requirements by prompting you to execute user guided test procedures, which you have predefined.
GWP History	Test history of tasks that were done based on the defined test sequence.
Internal Adjustment Weight	Built-in weight for adjustment.
Internal Test Weight	Built-in weight used for testing of adjustment.
Internal Weight	Built-in weight.
Method	A method describes the manner how a test is to be executed and formulates the core task of a test sequence. The weights to be used and the corresponding test or method tolerances must be defined as part of the method.
Method Tolerances	Tolerance that defines how much margin of error is allowed for the end result of a method.
Minimum Weigh	The smallest possible weight value that allows to fulfill the requirements of the relative precision (MinWeigh).
ProFACT	ProFACT (Professional Fully Automatic Calibration Technology) fully adjusts the balance automatically based on a pre-defined temperature criteria.
Repeatability	Capability of the balance to show consistent readings in repeated weighings using the same weight and under the same external conditions.
Repeatability Test	Checking of Repeatability.
Result Tolerances	Tolerance that defines how much margin of error is allowed for the end result of a method.
Routine Checks	Execution of different routine tests for balance checking.
Routine Test	Routinely executed test.

Sensitivity	The drift of the weight value divided by the causing load drift.
Sensitivity Test	Checking of sensitivity.
Task	Tasks define when the test sequence should be executed, how it should be started and for XP balances, which user should do the test sequence. Before a task can be defined, the test sequence should already be defined.
Test	Collective term for the checking of a single function or a whole device.
Test Sequence	Describes the manner of test (method) and with which weight this test should be executed. Furthermore, you also define the behaviour of the balance if the test fails. It also describes the tolerances for the test weight.
Test History	History of internal and external tests. It is a record of the test results that have been recorded in a memory that is specially secured against power failure. The options in the test history allows you to choose which results you want to view or print out in the documentation.
Test Tolerances	Tolerance that defines how much margin of error is allowed for an individual weight measurement in a test.
Test Weight	An external weight piece which is used as reference measurement.
Testing of Adjustment	Corresponds to the sensitivity test in accordance to GWPExcellence™ Nomenclature.
Warning Limit	Tolerance of a process relative to its target value. Violation of this limit is not in itself an infringement of the quality requirements, but indicates drift of the process and therefore requires more intensive monitoring of the process.
Weight Tolerances	a) Tolerances of external weights that are specified on the certificate, or b) Tolerances that pertain to a measured weight (Ex. Tare weight).

5 Index

A

Action after Failure 14
Action if Failure 12
Actual Value 9
Actual Weight 37
Adj. History 35
Adj. History Selection 35
Adjust/Test 6
Administrator 6
Advanced Options 32
As Found 32
As Left 32
Attempts 12, 14
Automatic Adjustment 33
Automatic Adjustment Testing 34

B

Balance ID 37
Balance Info 6
Balance Type 37
Battery Change 22
Blocking 32

C

Certificate No. 9, 37
Class 9
Code to Unblock 13, 33
Control Limit 16

D

Date/Time 6, 37
Days 31
Defined Days 29
Defined Users 30
Difference 37

E

Early Warning Alert 23
Eccentricity Test 17
EC Method for Eccentricity Test 17
Entry in GWP History 13
External weights 8

G

Glossary 38
Good Weighing Practice™ 4
GWBase™ 4
GWPExcellence™ 4, 39
GWP Functions 38
GWP History 36

I

Instructions if Failure 13
Interval 28
Introduction 4, 38

L

Levelcontrol 6, 37
Leveling 32

M

Manual 28
Max. Number of Warning 14
Method 12, 15
MinWeigh 22

N

Name of Tolerance1 16
Name of Tolerance2 16
Next Calibration 9
Nominal Weight 37
Number of Repetitions 18, 20

O

On Power On 29
On User Change 28

P

Peripherals 6
Preparation Instructions 12
ProFACT / int. Adj. 31
Protocol Trigger 31

R

RP1 Method for Repeatability Test 18
RPT1 Method for Repeatability Test with Tare 19

S

SE1 Method for Sensitivity Test with 1 Testpoint 20
SE2 Method for Sensitivity Test with 2 Testpoints 21
Service 22
SERVICE Method for Reminder / Early Notification 22
SET1 Method for Sensitivity Test with Tare and 1 Testpoint 24
SET2 Method for Sensitivity Test with Tare and 2 Testpoints 25
Signature 37
SNR (serial numbers) 37
Standby-Modus 6
Starting Method 28
Status 22
SW-Version 37

T

Tare Weight 19, 24, 25
Task 26
Task 01 - 12 22
Task List 26
Task State 27
Temp. Criterion 31
Temperature 37
Test History 35
Test Sequence Name 11
Test sequences 10
Test Sequence Version Number 11
Test Weight 17, 18, 19, 20, 24
Test Weight 1 21, 25
Test Weight 2 21, 25
Time 33, 34
Time 1...Time 3 31
Time Interval 14
Tolerances 32
Tolerances s 18, 20
Tolerance T1 16
Tolerance T2 16
Tol for Eccentricity Dev 17

U

User Name 37

W

Warning 12
Warning Message 13
Weekdays 33, 34
Weight Cal. 22
Weight ID 9, 37
Weight Name 9
Weight Set No. 9

GWP® – Good Weighing Practice™

The global weighing guideline GWP® reduces risks associated with your weighing processes and helps to

- choose the appropriate balance
- reduce costs by optimizing testing procedures
- comply with the most common regulatory requirements

► www.mt.com/GWP

www.mt.com/excellence

For more information

Mettler-Toledo AG Laboratory & Weighing Technologies

CH-8606 Greifensee, Switzerland

Tel. +41 (0)44 944 22 11

Fax +41 (0)44 944 30 60

www.mt.com

Subject to technical changes

© Mettler-Toledo AG 10/2010

11781338A 2.12

