

Operating Instructions

METTLER TOLEDO

EL – Education Line of balances

- Analytical and Precision
- Portable



METTLER TOLEDO

Operating instructions in a nutshell

 Press key **briefly**

 Press and **hold key down** until the desired display appears

▼ automatic sequence

Switching on

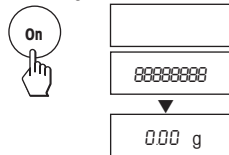

Switching off

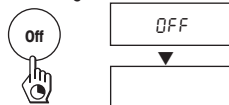

Simple weighing

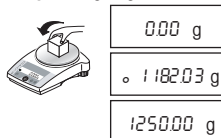

Adjusting (calibration) internal

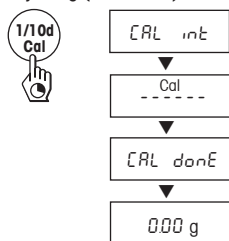

Adjusting (calibration) external

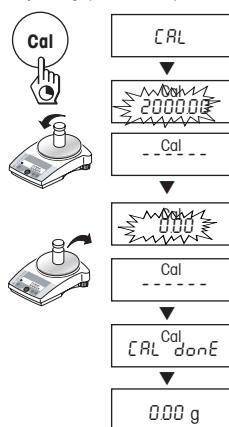

Recall weight / Recall weight value*

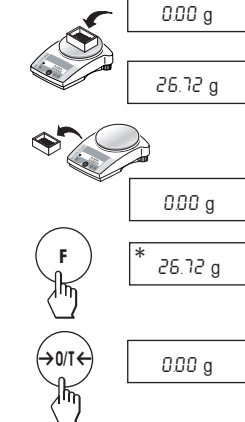

Percent weighing*

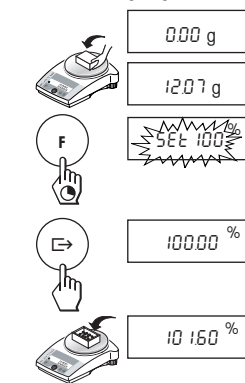

Taring

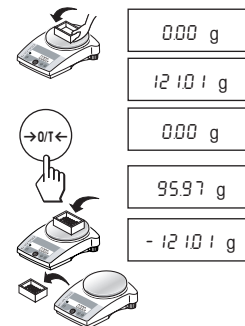

Free Newton factor / selectable display increment*

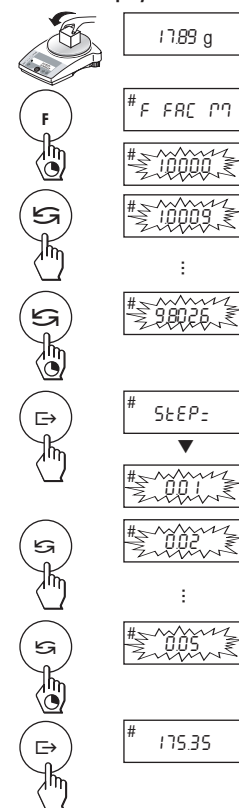

* These functions must be activated in the menu (section 4.3.2)

Contents

1 Getting to know EL balances line.....	4	5 Functions	16
1.1 General	4	5.1 Recall weight / Recall weight value.....	16
1.2 Layout of balances	4	5.2 Percent weighing	16
1.3 Overview of key functions.....	5	5.3 Weighing with free Newton factor and/or selectable display increments	17
2 Startup	6	6 Technical data, options, optional equipment	19
2.1 Unpacking / standard equipment.....	6	6.1 Technical data	19
2.2 Cautionary notes	6	6.2 RS232C interface	22
2.3 Setting up, leveling, preparations for weighing below the balance	6	6.3 MT-SICS Interface commands and functions	22
2.4 Adjusting (calibration)	8	6.4 Optional equipment	24
3 Weighing	9	6.5 Dimensional drawings (in mm)	25
3.1 On/Off switching.....	9	7 Appendix	26
3.2 Simple weighing	9	7.1 Typical printouts from METTLER TOLEDO RS-P26 and LC-P45 printers	26
3.3 Faster weighing with reduced readability	9	7.2 What if ...?	27
3.4 Taring	9	7.3 Maintenance and cleaning	28
4 Menu.....	10	7.4 Declaration of conformity	29
4.1 Overview	10		
4.2 Menu operation	11		
4.3 Description of menu options	11		

1 Getting to know EL balances line

1.1 General

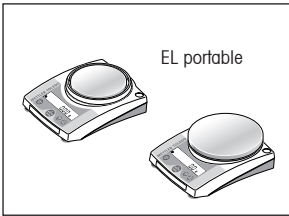
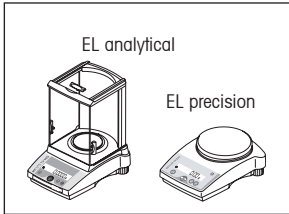

Balance features

- The EL balance line ranges from high-resolution analytical balances with a readability of 0.1 mg through to precision and portable balances with a readability of 0.001 g to 1 g. The weighing ranges extend from 120 g to 6.2 kg.
- In addition to basic operations such as **weighing**, **taring** and **adjusting** (calibration) miscellaneous functions such as **"Recall weight"**, **"Percent weighing"**, or **"Free Newton factor"** can be activated.
- Several EL balances are fitted with a glass draft shield in the factory; with other models a draft shield is available as an optional extra.

1.2 Layout of balances

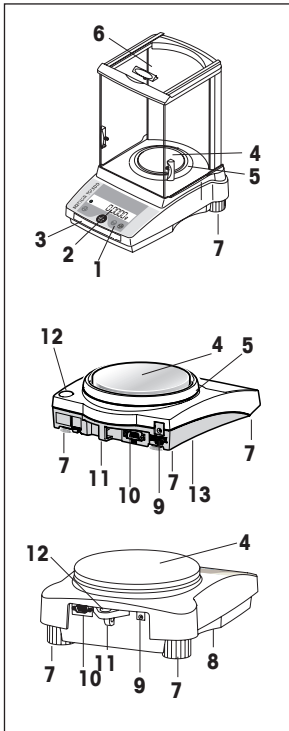





- 1 Keys
- 2 Display
- 3 Model plate with the following data:
"Max": maximum capacity
"d": readability
- 4 Weighing pan
- 5 Draft shield element (not on all models)
- 6 Draft shield (supplied as standard with models with a readability of 0.1 mg and 1 mg)
- 7 Leveling feet (not all models)
- 8 Hanger opening for weighing below the balance (underside of balance)
- 9 AC adapter socket
- 10 RS232C interface (optional on EL portable)
- 11 Lug for optional anti-theft device
- 12 Leveling control (not all models)
- 13 Compartment for batteries (only with EL portable models)



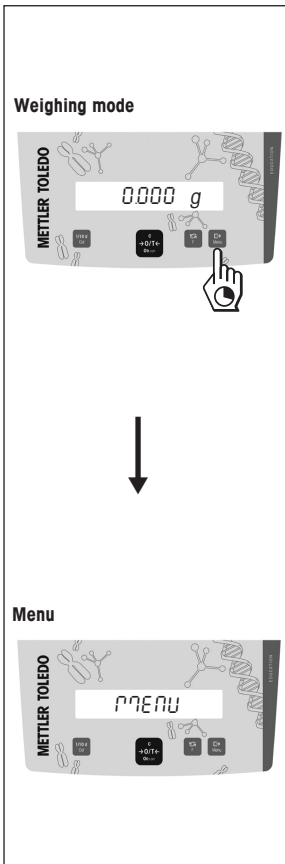

Keys and display are identical for all EL balances.

1.3 Overview of key functions

The balances have two operator control levels: the **weighing mode** and the **menu**. The function of each individual key depends on the operator control level and how long the key is pressed.



Key functions in weighing mode	
Press briefly 	Press and hold down 
1/10d <ul style="list-style-type: none"> Reduce readability 	Cal <ul style="list-style-type: none"> Adjust (calibrate)
On →0/T← C <ul style="list-style-type: none"> Switch on Zero/tare Cancel function 	Off <ul style="list-style-type: none"> Switch off
 <ul style="list-style-type: none"> Switch Change settings 	F <ul style="list-style-type: none"> Call function; A function must be activated in the menu, otherwise "F nonE" appears in the display
 <ul style="list-style-type: none"> Transfer weighing data via interface with activated printer Confirm settings 	Menu <ul style="list-style-type: none"> Show menu (hold key down until MENU appears)

Key functions in menu mode	
Press briefly 	Press and hold down 
1/10d <ul style="list-style-type: none"> Change settings Reduce value by 1 step 	1/10d <ul style="list-style-type: none"> Reduce value rapidly
C <ul style="list-style-type: none"> Close menu (without saving changes) 	—
 <ul style="list-style-type: none"> Change settings Increase value by 1 step 	 <ul style="list-style-type: none"> Increase value rapidly
 <ul style="list-style-type: none"> Select next menu item 	Menu <ul style="list-style-type: none"> Save changes and close menu

2 Startup

2.1 Unpacking / standard equipment

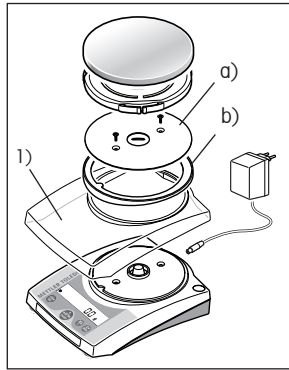
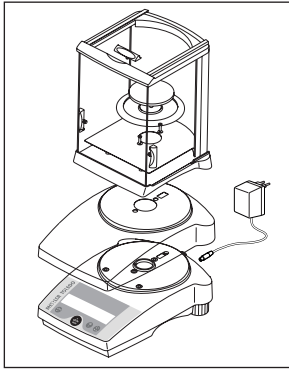

The standard equipment for every balance comprises:

- **AC adapter**, to national standard
- **Weighing pan, Weighing pan support, draft shield element** (depending on model)
- **Draft shield** standard supply with models of 0.1 / 1 mg readability (for other models available as an optional extra)
- **Operating Instructions**
- **Protective cover for EL portable balances** (placed on the balance over the weighing cell cone) with instruction sheet. **This protective cover must not mislaid.**
- **In-use cover**

1) In the case of models having the large weighing pan (ø 160 mm) the antistatic plate **a**) (secured by two screws) and the adapter ring **b**) must also be removed in order to fit the in-use cover.

2.2 Cautionary notes



- EL balances must **not** be operated in **hazardous areas** with the standard-supply AC adapter.
- Before connecting the AC adapter, verify that the voltage printed on it corresponds to the local AC power supply voltage. If this is not the case, please contact your local METTLER TOLEDO dealer.
- EL balances may only be used indoors in a dry environment.
- For use with CSA Certified (or equivalent approved) power source, which must have a limited and SELV circuit output.

2.3 Setting up, leveling, preparations for weighing below the balance

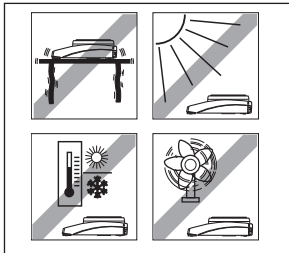

The optimum location

The correct location makes an important contribution to the accuracy of the weighing results of high-resolution analytical and precision balances.

- Stable, vibration-free position as horizontal as possible
- No direct sunlight
- No excessive temperature fluctuations
- No drafts

The best location is on a stable bench in a corner protected against drafts, as far away as possible from doors, windows, radiators or the louvers of air conditioners.

Leveling

Some models are equipped with a level glass and two or four leveling feet to compensate for minor irregularities in the surface on which the balance stands. The balance is exactly horizontal when the air bubble is in the middle of the level glass.

Note: The balance should be leveled each time it is moved to a new location.

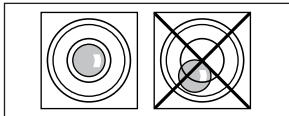

Preparations for weighing below the balance

To carry out weighing operations below the balance, get rid of the special cover on the underside of the balance. (**Note: never put the balance without the protective cover over its cone down on its head, only on its side!**). This exposes the opening for the hanger, making weighing below the balance possible.

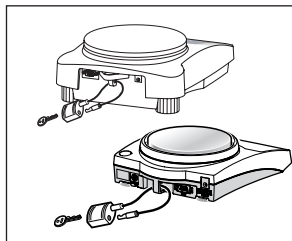

Antitheft device

All models are provided with a lug for attaching an antitheft device (see optional equipment in Section 6.4).

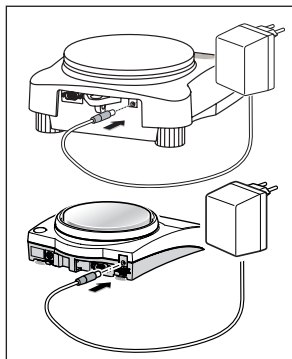

Power supply

- Plug the AC adapter into the AC adapter socket on the balance, and connect to the power supply.
- The balance performs a self-test. This test is finished when "OFF" appears.
- Press the **«On»** key briefly: the balance is in operational readiness. Before any work is performed with the balance, it must be adjusted (Section 2.4).

Notes

To achieve accurate results with analytical balances, they must be left switched on for at least 60 minutes to reach operating temperature before carrying out the first weighing operation.

Battery operation (portable models only)

Models in the portable line of balances can also be operated independently of the AC power supply by using their batteries. To do this, **always fit the protective cover over the weighing cell cone first**, then open the cover of the battery compartment on the underside of the balance and insert the batteries.

Caution: ensure correct polarity (as specified inside the battery compartment).

Close battery compartment again.

When the balance is operating on its batteries, the border around the battery symbol in the display lights up. The number of segments that are lit is an indicator of battery condition (3 = fully charged, 0 = discharged). When the batteries are almost completely discharged, the last segment flashes.

Recommended battery type: AA (LR6) 1.5 V alkali-manganese.

NiMH (nickel-metal hydride) rechargeable batteries, which are recharged in an external battery charger, can be also be used. The intervals between recharging are not as long as the service life of a nonrechargeable battery.

Notes

- Batteries are not included in the standard supply.
- Battery operation is automatically overridden when the AC adapter is connected to the AC power supply.
- To prolong battery (disposable or rechargeable) life, it is advisable to activate «Auto shut» in the menu (see Section 4.3.7).
- All discharged batteries must be disposed of in an environmentally responsible manner. No attempt must be made to incinerate or disassemble them.
- EL analytical and EL precision models cannot be operated with batteries.



2.4 Adjusting (calibration)

To obtain accurate weighing results, the balance must be adjusted to match the gravitational acceleration at its location.

Adjusting is necessary

- before the balance is used for the first time
- at regular intervals during weighing service
- after a change of location

To obtain accurate results, the balance must be left switched on for 60 minutes to reach operating temperature before starting the adjustment procedure.

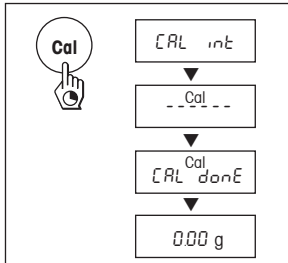

Adjusting with internal weight (EL-IC models only)

- To carry out this operation, in the second menu option (Adjustment) select "CAL int" (= factory setting) (section 4.1).
- Unload weighing pan.
- Press and hold the «Cal» key down until "CAL" appears in the display, then release key.
- The balance adjusts itself automatically.
The adjusting is finished when the message "Cal done" appears briefly in the display, followed by "0.00 g". The balance is again in weighing mode and ready for operation.

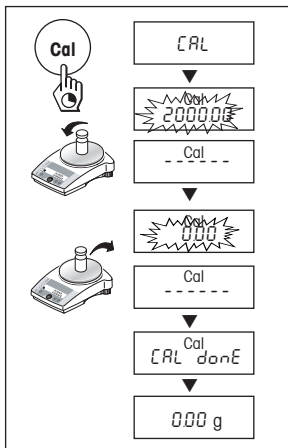

Adjusting with external weight

- Have required adjusting weight ready.
- Unload weighing pan.
- Press and hold the «Cal» key down until "CAL" appears in the display. Release key.
The required adjustment weight value flashes in the display.
- Place adjustment weight in centre of pan. The balance adjusts itself automatically.
- When "0.00 g" flashes, remove adjustment weight.
The adjusting is finished when the message "CAL done" appears briefly in the display, followed by "0.00 g". The balance is again in weighing mode and ready for operation.

Notes

- This adjustment procedure can be terminated at any time with the «C» ("Cancel") key. The balance reverts to weighing mode.

3 Weighing

3.1 On/Off switching

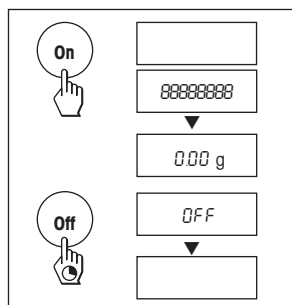

Switching on

- Remove any load from weighing pan and press «On» key briefly.
The balance performs a display test (all segments in the display light up briefly).
When zero is displayed, the balance is ready for operation.

Switching off

- Press and hold the «Off» key down until "OFF" appears in the display. Release the key.

3.2 Simple weighing

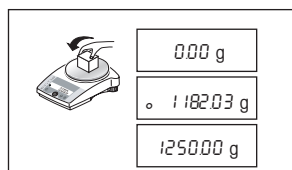

- Place weighing sample on the weighing pan.
- Wait until the stability detector "o" disappears.
- Read the result.

3.3 Faster weighing with reduced readability

The balance has the facility for speeding up the weighing operation by reducing its readability (number of decimal places):

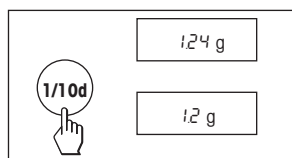

- The balance is operating with its **normal readability and speed**.
- Press the «1/10d» key and ...
- ... the balance operates with reduced readability (one decimal place less), but displays the weighing result quicker. Pressing the «1/10d» key briefly again toggles the balance back to its full readability.

3.4 Taring

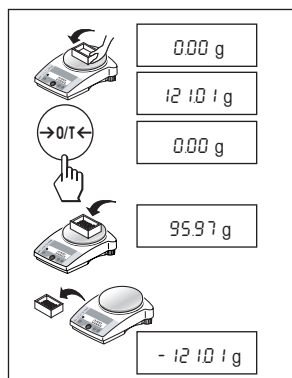

- Place empty container on the balance.
- The weight is displayed.
- Press the «→0/T←» key briefly.
- Add weighing sample to container. The net weight is now displayed.

If the container is removed from the balance, the tare weight will be shown as a negative value.

The tare weight remains stored until the «→0/T←» key is pressed again or the balance is switched off.

4 Menu

4.1 Overview

In the menu you can change the weighing unit, select additional functions and carry out various settings. A description of the individual menu options is given in Section 4.3.

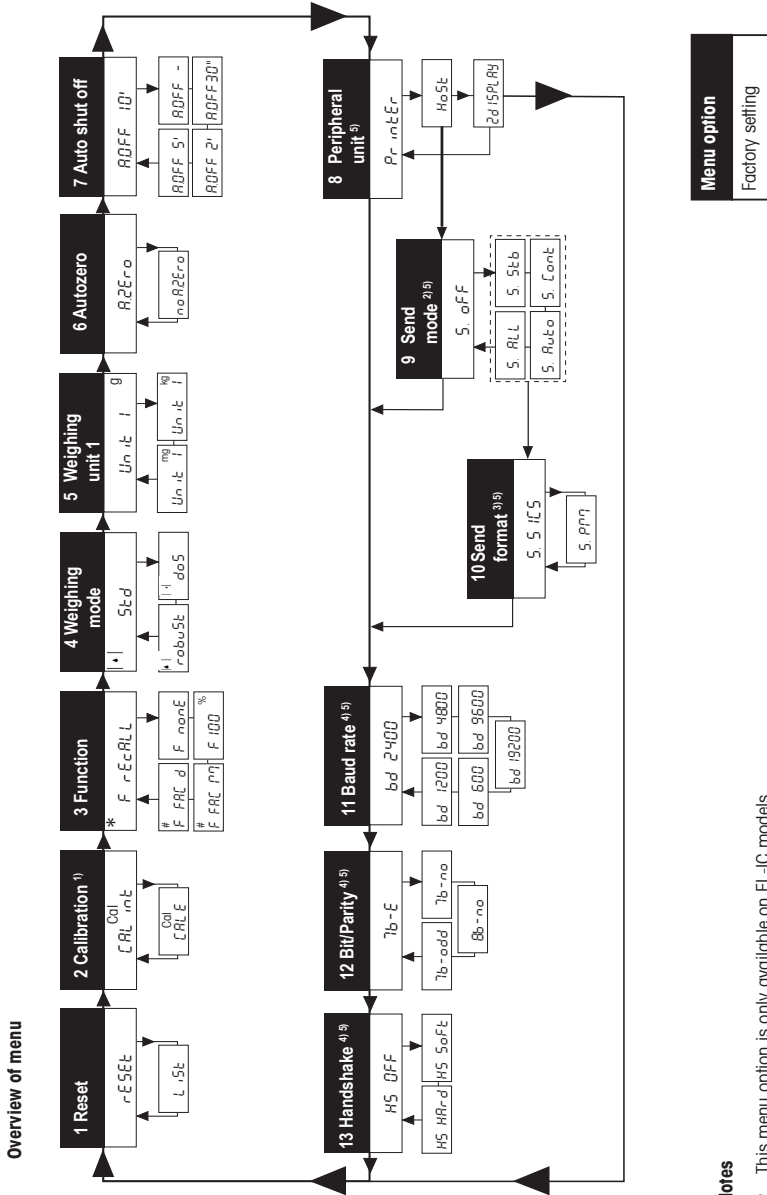

Notes

- 1) This menu option is only available on EL-IC models.
- 2) This menu option is only shown if "Host" has been selected in menu option 8 (Peripheral unit).
- 3) This menu option is only shown if "S.oFF" has not been selected in menu option 9 (Send mode).
- 4) These menu options are only shown if "Host" or "Printer" has been selected in menu option 8 (Peripheral unit).
- 5) Only displayed if an interface has been installed.

4.2 Menu operation

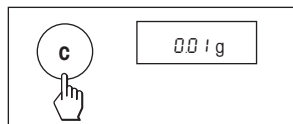
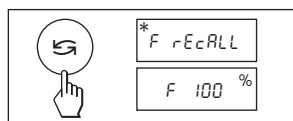
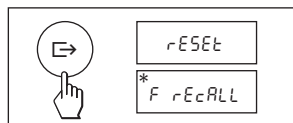
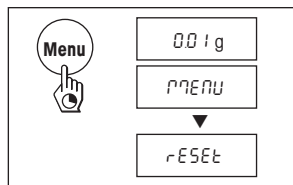

Opening the menu

In weighing mode, press and hold down the «Menu» key until "MENU" appears in the display. Release the key: the 1st menu option is displayed.

Select menu options

The « \rightarrow » key is used to select individual menu options with their current settings one after the other.

Change settings

Pressing the « \leftarrow » key displays the next setting; pressing the «1/10d» key displays the previous one. Once the desired setting appears in the display, the next menu option can be selected (« \rightarrow ») or you can close the menu (see following Section).

Saving settings and closing the menu

Hold the «Menu» key down until "StorEd" appears in the display. Release the key and the balance reverts to weighing mode. All changes are saved.

Abort

Press the «C» key briefly. The balance reverts to weighing mode. Changes are **not** saved.

Note

If no entry is made within 45 seconds, the balance reverts to weighing mode. Changes are **not** saved.

4.3 Description of menu options

4.3.1 Reset or recording of balance settings (1st menu option "RESET")



Reset balance settings

→ Select "Reset", press and hold down the «Menu» key until the message "r donE" confirms that all menu settings have been reset. The balance then reverts to weighing mode and works with the factory settings (Section 4.1).

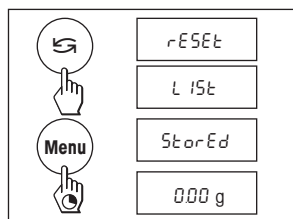

Recording balance settings

→ Select "List" and hold down the «Menu» key until the message "StorEd" is displayed.

The current balance settings are transmitted to the peripheral device connected to the optional RS232C interface. To do this the setting "Printer" must always be selected at the 8th menu option (Peripheral unit). The current balance settings are saved at the same time.

4.3.2 Adjustment (2nd menu option) (EL-IC models only)

In this menu option you can select whether you wish to adjust the balances using the internal or the external adjustment weight:

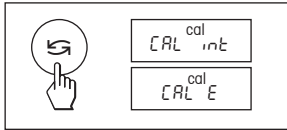

- CAL int Adjusting with internal adjustment weight (factory setting)
- CAL E Adjusting with external adjustment weight

4.3.3 Functions (3rd menu option / see Section 5 for their use)

In addition to simple weighing, the following functions can be selected with the «G» key:

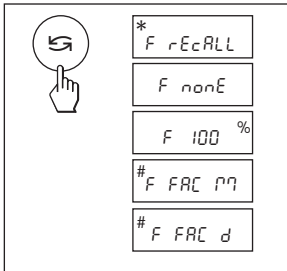

- F rEcALL Recall weighing
- F nonE No function, simple weighing
- F 100 % Percent weighing
- F FAC M Multiply free Newton factor value by weight, change size of display increment
- F FAC d Divide free Newton factor value by weight, change size of display increment

4.3.4 Weighing mode (4th menu option)

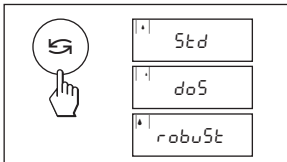

This setting allows you to adapt the balance to the weighing mode. Select "Std" (standard) for all normal weighing processes. With "doS" (dosing) - for dispensing substances in liquid or powder form - the balance reacts very rapidly to the slightest changes of weight. With "robuSt" (absolute weighing) the balance only reacts to more significant changes in weight, so that the weighing result is very stable.

4.3.5 Weighing unit 1 (5th menu option "UNIT 1")

Depending on requirements, the balance can operate with the following units:

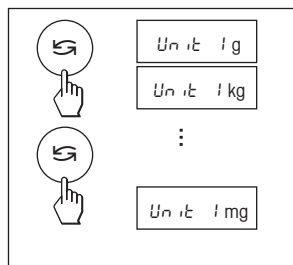

Unit	Conversion factor	Comments
g gram		factory setting
kg kilogram	1 kg = 1000 g	not with 0.1 mg and 1 mg balances
mg milligram	1 mg = 0,001 g	with 0.1 mg and 1 mg balances

4.3.6 Autozero (6th menu option / see overview and notes in Section 4.1)

This menu option allows you to switch the automatic zero correction on or off.

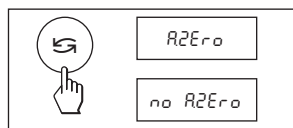

Autozero switched on

The zero point is automatically corrected (e.g. if drift occurs or the weighing pan becomes dirty).

Autozero switched off

The zero point is **not** automatically corrected. This setting is advantageous for special applications (e.g. evaporation measurements).

4.3.7 Auto shut off

If the automatic shut off function is activated, the balance automatically switches itself off after a selected period of inactivity (i.e. with no key being pressed or changes of weight occurring):

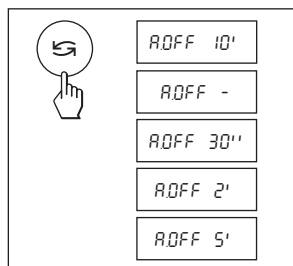

A.OFF 10'	Automatic shutoff after 10 minutes inactivity
A.OFF -	Automatic shutoff not activated
A.OFF 30"	Automatic shutoff after 30 seconds inactivity
A.OFF 2'	Automatic shutoff after 2 minutes inactivity
A.OFF 5'	Automatic shutoff after 5 minutes inactivity

4.3.8 Peripheral unit (8th menu option / see overview and notes in Section 4.1)

Peripheral devices can only be connected if the balance has been equipped with an RS232C interface. The balance automatically saves the appropriate settings (Sections 4.3.9 – 4.3.13) for every peripheral device.

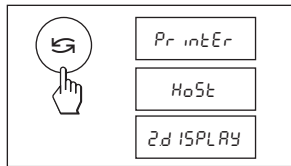

- Printer Connected to a printer.
- Host Connection to any desired peripheral device.
- Aux. display Connection of an optional auxiliary display unit (communications parameters cannot be selected).

4.3.9 Send mode (9th menu option / see overview and notes in Section 4.1)

Note: This menu option is only available if the "Host" setting was selected in the 8th menu option (Peripheral unit)! It specifies how a value is transferred to a peripheral device.

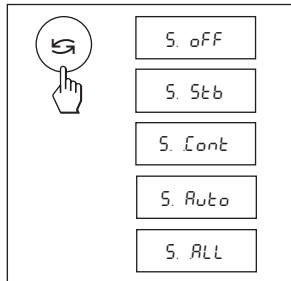

- S. OFF Send mode switched off.
- S. Stb The next possible stable value will be transferred after the « \rightarrow » key has been pressed.
- S. Cont All values are transferred automatically.
- S. Auto Only stable values are transferred automatically.
- S. All The current value is transferred after the « \rightarrow » key has been pressed.

4.3.10 Send format (10th menu option / see overview and notes in Section 4.1)

Note: This menu option is only available if the "S. OFF" setting was **not** selected in the 9th menu option ("Send mode")! It sets the data transfer format.

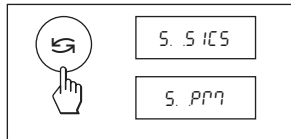

"S. SICS": The MT-SICS data transfer formats are used. Please refer to the "Reference Manual MT-SICS B-S/L/L-S balances 11780447", available from your METTLER TOLEDO dealer or downloaded from the Internet (www.mt.com/sics-classic).

More Information please find in the Section 6.3.

- "S. PM*": The following PM balance data transfer formats are used:
 - S. Stb: `cccc1.67890g`
 - S. Cont: `Scccc1.67890g SDcccc1.39110g`
 - S. Auto: `Scccc1.67890g`
 - S. All: `cccc1.67890g`
`gDcccc1.39110g`

* unidirectional, no MT-SICS commands are accepted.

4.3.11 Baud rate (11th menu option / see overview and notes in Section 4.1)

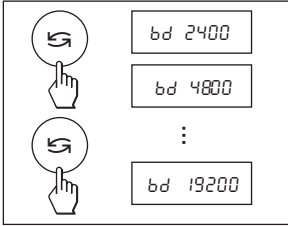

Note: This menu option is only available if the "Printer" or "Host" setting was selected in the 8th menu option (Peripheral unit)!

The baud rate (data transfer rate) determines the speed of transmission via the serial interface. The unit is the baud (bd) = 1 bit/second.

The following settings are available: 600 bd, 1200 bd, 2400 bd, 4800 bd, 9600 bd and 19200 bd.

For problem-free data transmission the sending and receiving devices must be set at the same value.

4.3.12 Bit/Parity (12th menu option / see overview and notes in Section 4.1)

Note: This menu option is only available if the "Printer" or "Host" setting was selected in the 8th menu option (Peripheral unit)! It sets the character format for the peripheral device connected to the balance.

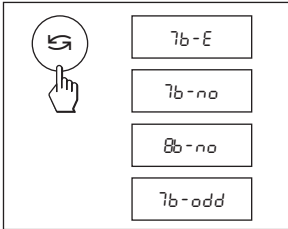

- 7b-E 7 data bits/even parity
- 7b-no 7 data bits/no parity
- 8b-no 8 data bits/no parity
- 7b-odd 7 data bits/odd parity

4.3.13 Handshake (13th menu option / see overview and notes in Section 4.1)

Note: This menu option is only available if the "Printer" or "Host" setting was selected in the 8th menu option (Peripheral unit)! This function is used to select the data transfer mode to suit different serial devices.

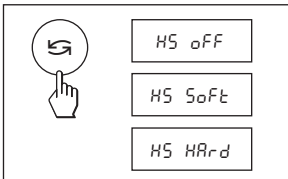

- HS oFF No handshake
- HS SoFt Software handshake (XON/XOFF)
- HS HAr d Hardware handshake (RTS/CTS)

5 Functions

Settings and values saved under a given function are retained until they are replaced or another function is selected. The «C» key can be used to cancel the procedure currently in progress.

5.1 Recall weight / Recall weight value

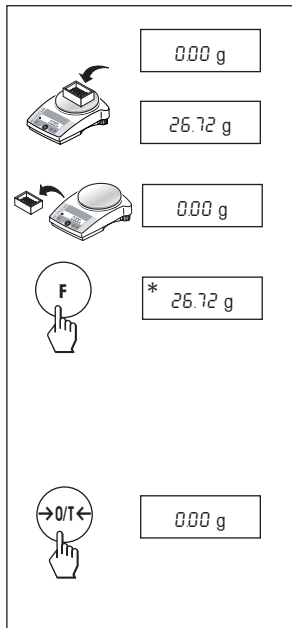

Requirement

The function "RecALL" must be activated in the menu (Section 4).

- Put weight on balance.
Display shows weight value and stores stable value.
- Remove weight.
When the weight is removed the Display shows zero.

- Press the «F» key briefly

The display **shows** last stored stable weight value **for 5 seconds** together with asterisk (*) symbol. After 5 seconds or by pressing the «F» key briefly, the display goes back to zero. This can be repeated unlimited times. Every recalled value is marked with the asterisk (*) icon.

Delete last weight value

As soon a new stable weight value is displayed, the old value becomes replaced by the new weight value.

- When pressing the « $\rightarrow 0/T \leftarrow$ » key briefly, the stored value is set to 0 and normal tare is executed.

Note: If the power is switched off, the stored value is permanently lost.

5.2 Percent weighing

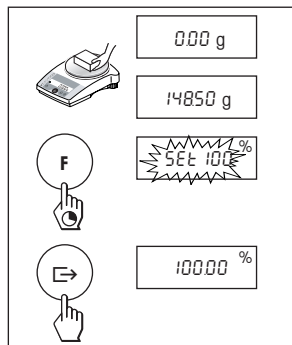

Requirement

The function "F 100 %" must be activated in the menu (Section 4).

Set target weight

- Target weight (Reference weight, which corresponds to 100 %) in centre of pan.
Note that the minimum weight = 10d (d: display increment).

- Hold the «F» key down until "Set 100 %" is displayed.

- Press the « $\rightarrow \leftarrow$ » key to select "Set 100 %" or "Set no %" (Percent weighing deactivated).

- The « $\rightarrow \leftarrow$ » key can be used briefly to confirm or automatic acceptance after 7 seconds.

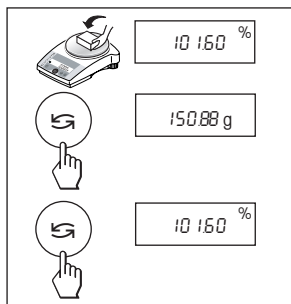

Switching between percent weighing and weight display

- Place weighing sample in centre of pan.
The weight of the sample is displayed as a percentage of the target weight.
- Press the «TARE» key. The weight is displayed.
- Return to display in percent: pressing the «TARE» key again.

5.3 Weighing with free Newton factor and/or selectable display increments

In this menu option a custom “free Newton factor” can be defined at will.

The unit Newton measures the amount of force required to accelerate a mass of one kilogram at a rate of one meter per second squared.

$$1 \text{ N} = 1 \text{ kg} \cdot \text{m/s}^2$$

The factor m/s^2 is also called gravitational acceleration. Newton is dependant on the geographical location and height of the balance and its user - hence making it necessary to adjust the unit according to the precise location. In this menu option a custom “free Newton factor” can be defined at will.

This value is then either multiplied (“F FAC M”) by the weighing result (in grams), i.e. reading = factor x weight, or it is divided (“F FAC d”) by the weight, i.e. reading = factor / weight. The range over which this factor can be selected depends on the weighing range and the readability of the model concerned.

Location	Gravity Acceleration
Berlin	9.8127
Brussels	9.8114
Cairo	9.7932
Guayaquil	9.7806
Helsinki	9.8190
Kuala Lumpur	9.7802
London	9.8120
Los Angeles	9.7955
Madrid	9.7996
Melbourne	9.7997
Miami	9.7903
Nairobi	9.7753
New York	9.8026
Oslo	9.8192
Paris	9.8093
Reykjavik	9.8226
Shanghai	9.7941
Singapur	9.7802
Tokyo	9.7979
Washington	9.8009

The ability to select the display increments makes it possible to specify how the weighing result is to be presented, the choice of display increments being limited by the set factor and the resolution of the balance model itself.

Requirement

The function "F FAC M" or "F FAC d" must be activated in the menu (Section 4).

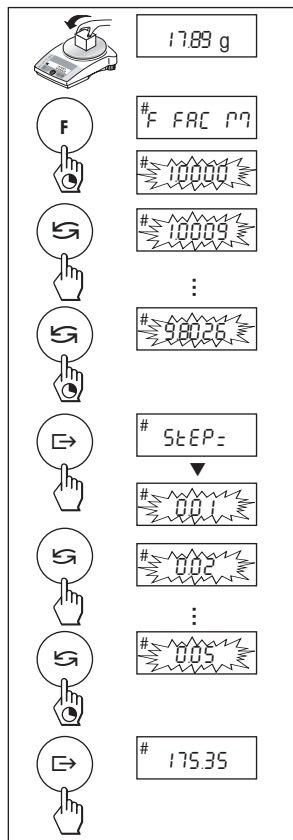

Entering the free Newton factor and/or the display increments

- Hold the «F» key down until "F FAC M" or "F FAC d" appears in the display.
- Press the «5» key to select "FAC M" / "FAC d" or "noFAC M" / "noFAC d" (Function deactivated).
- Release the key. Either the factor 1 appears as default value or the factor that was saved most recently.

This value can now be changed:

- Pressing the «5» key increases the factor.
- Pressing the «1/10d» key reduces the factor.

Pressing the key once changes the value by one increment. If the key is held down, the value changes increasingly rapidly.

- Confirm the selected factor with the «E» key (it will not be saved automatically). "StEP=" appears in the display, and the program changes automatically to allow the display increments to be entered. The smallest possible display increment appears as default value, or the last value that was saved.

- This value can be changed in the same way as for the free Newton factor (see above).

Confirm the selected display increment with the «E» key (it will not be saved automatically).

The appropriate calculation is then made using the weight on the pan in grams and the selected factor, the result being displayed with the selected display increment. **No units are displayed**, the symbol "#" being displayed instead. The calculation is always based on the weight in grams.

Note

- If you only want to change the display increments, set the free factor at exactly 1.

Toggling between displaying the calculated value and the measured weight

- Place the sample on the weighing pan. The appropriate calculation is then made using the weight of the sample and the selected factor, the result being displayed with the selected display increment.
- Press the «5» key. The weight is displayed.
- Press the «5» key again to return to the calculated value.

6 Technical data, options, optional equipment

6.1 Technical data

Standard equipment of EL balances

- AC adapter to national standard.
100–240 VAC/50–60 Hz, 0.3 A
12 VDC, 0.84 A
Balance power input 6-14,5VAC, 50/60Hz, 4VA or
7-20VDC, 4W
- Draft shield (on models with 0.1 / 1 mg resolution)
- All models can weigh below balance

Materials

- Housing base:
EL analytical / EL precision models: die-cast aluminum, painted
EL portable models: plastic (ABS/PC)
- Top housing: plastic (ABS/PC)
- Weighing pan: 18/10 chromium-nickel steel

Batteries (only with portable models)

- 4 x AA (LR6) 1.5 V alkali-manganese, typical 20 h (with 2.9 Ah capacity)

Protection

- Protected against dust and water
- Pollution degree: 2
- Installation category: class II
- EMC: see declaration of conformity

Ambient conditions

The technical data are valid under the following ambient conditions:

- Ambient temperature 10 °C ... 30 °C
- Relative humidity 10 % to 80 % at 31 °C, linear decreasing to 50 % at 40 °C noncondensing

Operability is assured at ambient temperatures between 5 and 40 °C.

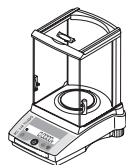

EL – analytical “0.1 mg”

	EL104	EL204-IC	EL204
Max. capacity	120 g	220 g	220 g
Readability	0.0001 g	0.0001 g	0.0001 g
Repeatability (sd)	0.0001 g	0.0001 g	0.0001 g
Linearity	0.0002 g	0.0002 g	0.0002 g
Sensitivity temperature drift (10 °C ... 30 °C)	2.5 ppm/°C	2.5 ppm/°C	2.5 ppm/°C
Settling time, typical	4 s	4 s	4 s
Adjustment weight internal	no	yes	no
Adjustment weight external (optional)	100 g	–	200 g
Interface RS-232C	yes (optional in Asia)		
External dimensions of balance	238x335x364 mm (W/D/H)		
External dimensions of packaging	520x385x555 mm (W/D/H)		
Weighing pan	ø 90 mm		
Usable height of draft shield	225 mm		
Net weight (with packaging)	5.8 kg (8.4 kg)		
Level indicator	yes		
Number of leveling screws	2		

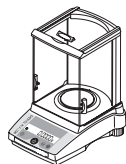
EL – analytical “mg”

	EL203-IC	EL203	EL303-IC	EL303	EL403-IC	EL403
Max. capacity	220 g	220 g	320 g	320 g	420 g	420 g
Readability	0.001 g	0.001 g	0.001 g	0.001 g	0.001 g	0.001 g
Repeatability (sd)	0.001 g	0.001 g	0.001 g	0.001 g	0.001 g	0.001 g
Linearity	0.002 g	0.002 g	0.002 g	0.002 g	0.002 g	0.002 g
Sensitivity temperature drift (10 °C ... 30 °C)	6 ppm/°C	6 ppm/°C	6 ppm/°C	6 ppm/°C	6 ppm/°C	6 ppm/°C
Settling time, typical	3 s	3 s	3 s	3 s	3 s	3 s
Adjustment weight internal	yes	no	yes	no	yes	no
Adjustment weight external (optional)	—	200 g	—	200 g	—	200 g
Interface RS232C	yes (optional in Asia)					
External dimensions of balance	238x335x287 mm (W/D/H)					
External dimensions of packaging	520x385x555 mm (W/D/H)					
Weighing pan	ø 100 mm					
Usable height of draft shield	150 mm					
Net weight (with packaging)	5.1 kg (7.9 kg)					
Level indicator	yes					
Number of leveling screws	2					

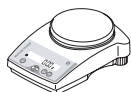
EL – precision

	EL2002-IC	EL2002	EL3002-IC	EL3002	EL4002-IC	EL4002
Max. capacity	2200 g	2200 g	3200 g	3200 g	4200 g	4200 g
Readability	0.001 g	0.01 g	0.01 g	0.01 g	0.01 g	0.01 g
Repeatability (sd)	0.01 g	0.01 g	0.01 g	0.01 g	0.01 g	0.01 g
Linearity	0.02 g	0.02 g	0.02 g	0.02 g	0.02 g	0.02 g
Sensitivity temperature drift (10 °C ... 30 °C)	6 ppm/°C	6 ppm/°C	6 ppm/°C	6 ppm/°C	6 ppm/°C	6 ppm/°C
Settling time, typical	1.5 s	1.5 s	1.5 s	1.5 s	1.5 s	1.5 s
Adjustment weight internal	yes	no	yes	no	yes	no
Adjustment weight external (optional)	—	2000 g	—	2000 g	—	2000 g
Interface RS232C	yes (optional in Asia)					
External dimensions of balance	238x335x111 mm (W/D/H)					
External dimensions of packaging	520x385x360 mm (W/D/H)					
Weighing pan	ø 180 mm					
Net weight (with packaging)	4 kg (6.4 kg)					
Level indicator	yes					
Number of leveling screws	2					



EL – portable

	EL202	EL302	EL402	EL602
Max. capacity	220 g	320 g	420 g	620 g
Readability	0.01 g	0.01 g	0.01 g	0.01 g
Repeatability (sd)	0.01 g	0.01 g	0.01 g	0.01 g
Linearity	0.02 g	0.02 g	0.02 g	0.02 g
Sensitivity temperature drift (10 °C ... 30 °C)	10 ppm/°C	10 ppm/°C	10 ppm/°C	10 ppm/°C
Settling time, typical	1.5 s	1.5 s	1.5 s	1.5 s
Adjustment weight internal	no	no	no	no
Adjustment weight external (optional)	200 g	200 g	200 g	500 g
Interface RS232C	optional			
External dimensions of balance	194x225x67 mm (W/D/H)			
External dimensions of packaging	350x275x140 mm (W/D/H)			
Weighing pan	ø 120 mm			
Net weight (with packaging)	1.0 kg (2.1 kg)	1.2 kg (2.2 kg)		
Level indicator	yes	yes		
Number of leveling screws	2	2		

EL – portable

	EL2001	EL4001	EL6001	EL6000
Max. capacity	2200 g	4200 g	6200 g	6200 g
Readability	0.1 g	0.1 g	0.1 g	1 g
Repeatability (sd)	0.1 g	0.1 g	0.1 g	1 g
Linearity	0.2 g	0.2 g	0.2 g	2 g
Sensitivity temperature drift (10 °C ... 30 °C)	10 ppm/°C	10 ppm/°C	10 ppm/°C	10 ppm/°C
Settling time, typical	2 s	2 s	2 s	1 s
Adjustment weight internal	no	no	no	no
Adjustment weight external (optional)	2000 g	2000 g	5000 g	5000 g
Interface RS232C	optional			
External dimensions of balance	194x225x67 mm (W/D/H)			
External dimensions of packaging	350x275x140 mm (W/D/H)			
Weighing pan	ø 160 mm			
Net weight (with packaging)	1.3 kg (2.3 kg)			
Level indicator	yes	yes	yes	no
Number of leveling screws	4	4	4	—

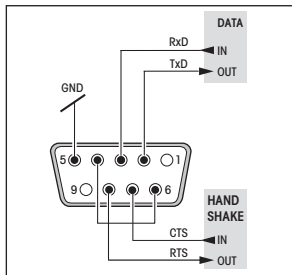
6.2 RS232C interface



Every balance can be equipped with an optional RS232C interface for connection to a peripheral device (e.g. printer, auxiliary display or PC with a 9-pin male connector, see Section 6.4). The balance must then be configured to suit the peripheral device in a menu dialog (Sections 4.3.8 – 4.3.13).

A detailed description of the available interface commands is given in the "Reference Manual MT-SICS B-S/L/L-S balances 11780447". This can be downloaded from the Internet (www.mt.com/sics-classic) and is only available in English.

The wide range of features of the EL balances regarding documentation of the results can be utilized by connecting to a printer, e.g. the RS-P26 or LC-P45 from METTLER TOLEDO. Printed results then make a decisive contribution to simplifying GLP/GMP-compliant work.

6.3 MT-SICS Interface commands and functions

Many of the balances used have to be capable of integration in a complex computer or data acquisition system. To enable you to integrate balances in your system in a simple manner and utilize their capabilities to the full, most balance functions are also available as appropriate commands via the data interface.

All new METTLER TOLEDO balances launched on the market support the standardized command set "METTLER TOLEDO Standard Interface Command Set" (MT-SICS). The commands available depend on the functionality of the balance.

Basic information on data interchange with the balance

The balance receives commands from the system and acknowledges the command with an appropriate response.

Command formats

Commands sent to the balance comprise one or more characters of the ASCII character set. Here, the following must be noted:

- Enter commands only in uppercase.
- The possible parameters of the command must be separated from one another and from the command name by a space (ASCII 32 dec., in this description represented as \square).
- The possible input for "text" is a sequence of characters of the 8-bit ASCII character set from 32 dec to 255 dec.
- Each command must be closed by C_{rLr} (ASCII 13 dec., 10 dec.).

The characters C_{rLr} , which can be inputted using the Enter or Return key of most entry keypads, are not listed in this description, but it is essential they be included for communication with the balance.

Example

S – Send stable weight value

Command	S	Send the current stable net weight value.
Response	S□S□WeightValue□Unit	Current stable weight value in unit actually set under unit 1.
	S□I	Command not executable (balance is currently executing another command, e.g. taring, or timeout as stability was not reached).
	S□+	Balance in overload range.
	S□-	Balance in underload range.

Example

Command	S	Send a stable weight value.
Response	S□S□□□□□□□100.00□g	The current, stable weight value is 100.00 g.

The MT-SICS commands listed below is a selected list of available commands. For additional commands and further information please refer to the Reference Manual "MT-SICS for B-S/L/L-S balances 11780447" downloadable from the Internet under www.mt.com/sics-classic.

S – Send stable weight value

Command **s** Send the current stable net weight value.

SI – Send value immediately

Command **sI** Send the current net weight value, irrespective of balance stability.

SIR – Send weight value immediately and repeat

Command **sIR** Send the net weight values repeatedly, irrespective of balance stability.

Z – Zero

Command **z** Zero the balance.

@ – Reset

Command **@** Resets the balance to the condition found after switching on, but without a zero setting being performed.

SR – Send weight value on weight change (Send and Repeat)

Command **SR** Send the current stable weight value and then send continuously the stable weight value after every weight change.
The weight change must be at least 12.5 % of the last stable weight value, minimum = 30d.

ST – Send stable weight after pressing  (transfer) key

Command **sT** Inquiry of actual status of the ST function.

SU – Send stable weight value with currently displayed unit

Command **sU** As the "s" command, but with the currently displayed unit.

6.4 Optional equipment

AC adapter

AC adapter universal (EU, USA, AU, UK) 11120270
100–240 VAC/50–60 Hz, 0.3 A
12 VDC, 0.84 A

AccuPac B-S

Rechargeable external power source for 21254691
18 hours weighing operation independent
of AC power supply

Adjustment weights

Available as OIML weights (E1, E2, F1, 11795461
with calibration certificate); for further details see
METTLER TOLEDO Weights brochure
or see www.mt.com/weights

Antitheft device

Cable with lock (for all models) 00590101

Auxiliary display ¹⁾

- Auxiliary display including RS cable 00224200
and separate AC adapter
- Auxiliary display with switchbox 12120057

Density kit

For analytical balances (0.1 mg / 1 mg) 00033360

Draft shield for EL portable models

Glass cylinder (see also weighing pan) 12102988

Draft shield for EL analytical and precision models

For "mg" balances (150 mm) 12105346

Interface RS232

The interface must be fitted in the factory. Retrofitting is only possible if carried out by a METTLER TOLEDO service facility.

Interface cable ¹⁾

- RS9–RS25: (m/f), length 2 m 11101052
- RS9–RS9: (m/f), length 1 m 11101051
- RS9–RS9: (m/m), length 1 m 21250066
- RS232–USB converter cable 11103691

In-use cover

- for EL analytical and precision models 12102970
- for EL portable models 12102980

Printer, Application printer (LC-P45) ¹⁾

Plain-paper printer, 24 characters, with 00229119
additional functions (time, date, statistic,
multiplier etc.)

Printer, Report printer (RS-P26) ¹⁾

Plain-paper printer, 24 characters, with 12120788
additional functions (date and time).

Software ¹⁾

LabX direct balance 11120340
(software for easy data transfer to PC)

Transport case

For EL portable models (without 12102982
draftshield); accommodates balance,
AC adapter, batteries and weights

Weighing pan

Only for EL portable models with ø 160 mm 12102987
weighing pan:
ø 120 mm weighing pan (+ pan holder
+ draftshield element for operation without a
draft shield):
necessary for use together with draft shield (12102988)

¹⁾ RS232 interface necessary

6.5 Dimensional drawings (in mm)

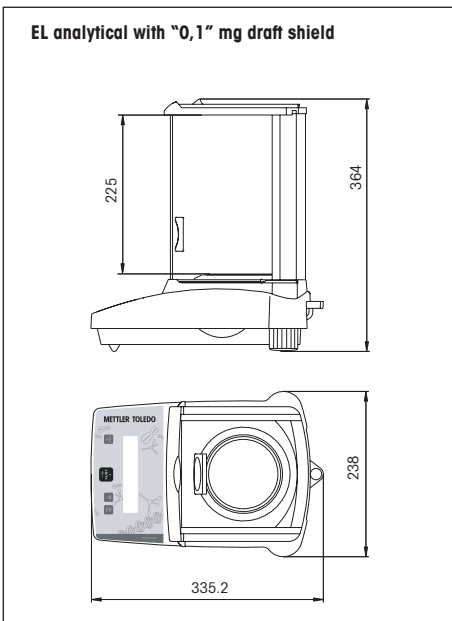
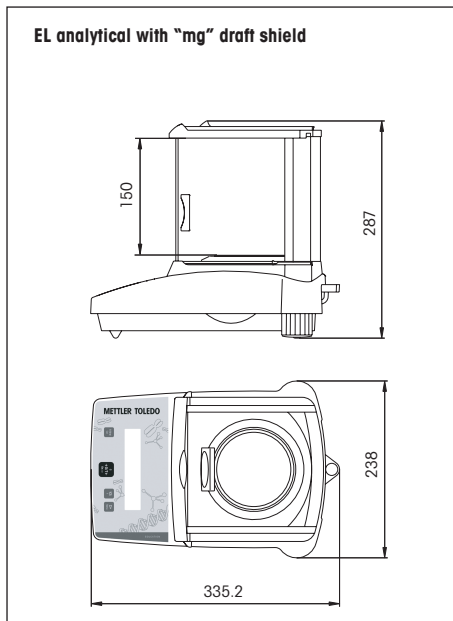
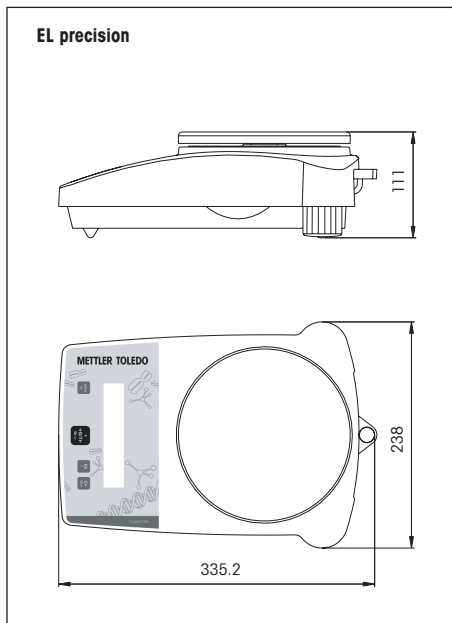
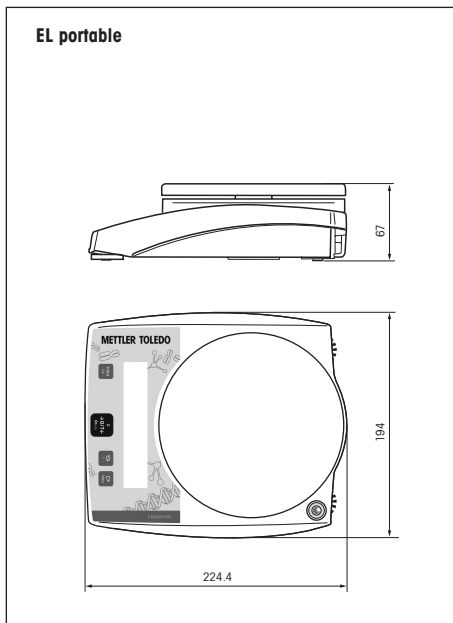

7 Appendix

7.1 Typical printouts from METTLER TOLEDO RS-P26 and LC-P45 printers

Function: Adjusting

```

-BALANCE CALIBRATION-
04.07.2006      09:50:12

METTLER TOLEDO
Type:           EL3002
SNR:            1120053108
SW:             1.0
Weight ID: .....
Weight:         2000.00 g

External Cal. done

Signature:

.....
----- END -----
    
```

Function: Percent weighing

```

----- % - WEIGHING -----
Ref.    10.008 g
        100.00 %

        60.01 g
        599.59 %
    
```

Function: Free factor

```

- FREE FACTOR WEIGHING -
Formula: factor * weight
Factor:   12.73
Step:    0.01

        49.94 #
    
```

Function: List

Printout of the current balance settings

```

--- LIST OF SETTINGS ---
04.07.2006      09:52:12

METTLER TOLEDO
Type:           EL602
SNR:            1120053108
SW:             1.0
TDNR:          7.17.1.286.108

Weighing Parameters:
Weighing Mode Standard
Unit 1          g
A.Zero         On

System Parameters:
Auto off       10 min

Peripheral Devices:
P.Device       Printer
Baud           2400
Bit/Parity     7b-even
Handshake      Off

P.Device       Host
Sendmode       Off
Baud           9600
Bit/Parity     8b-no
Handshake      Soft

----- END -----
    
```

Function: Multiplier

Only possible with LC-P45. Function is triggered via the printer.

```

04.07.2006      08:23:22
ID             242
SNR:           1118015657

Factor         1.65
              588.43 g
*              970.9095
    
```

Function: Verification of the calibration (adjustment) with external weight.

Only possible with LC-P45. Function is triggered via the printer.

```

----- BALANCE TEST -----
04.07.2006      09:55:12

METTLER TOLEDO
Type:           EL3002
SNR:            1120053108
SW:             1.0

Weight ID: .....

Target : .....
Actual : .....199.98 g
Diff   : .....

External test done

Signature:

.....
----- END -----
    
```

Function: Statistics

Only possible with LC-P45. Function is triggered via the printer.

```

04.07.2006      10:44:07
ID             666
SNR:           1118015657
1             1100.15 g
2             1600.10 g
3             1699.95 g
n             3
x             1466.733 g
s             321.372 g
srel         21.91 %
min.         1100.15 g
max.         1699.95 g
dif.         599.80 g





----- END -----
    
```

Notes

The operating instructions for the LC-P45 include a description of the functions that are triggered via that printer.

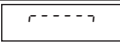
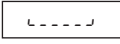
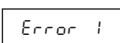
The **RS-P26** prints all reports in **English**. This applies also to the **LC-P45** reports that originate in the balance. In the case of reports triggered by the **LC-P45**, the following languages may be selected: **German, English, French, Spanish or Italian**.

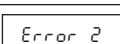
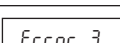
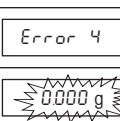
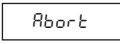
7.2 What if ...?

Error/Error message	Cause	Rectification
	Overload	→ Remove sample from weighing pan, zero again (tare).
	Underload	→ Check whether weighing pan is positioned properly.
	No stability <ul style="list-style-type: none"> • in taring or adjusting (calibration) 	<ul style="list-style-type: none"> → Wait for stability before pressing key. → Ensure more stable ambient conditions. → Remove weighing pan and clean if necessary
	Wrong adjustment weight on pan or none at all	→ Place required adjustment weight in centre of pan.
	Reference weight (Percent weighing) too small	→ Increase reference weight.
	Internal fault	→ Contact METTLER TOLEDO customer service.
	Wrong weighing pan or pan missing or not empty	→ Place correct pan or empty pan on balance.
	Adjustment aborted with the «C» key	
	No display <ul style="list-style-type: none"> • AC adapter not plugged in • Batteries discharged (only with compact models) 	<ul style="list-style-type: none"> → Check AC power supply. Plug AC adapter into power supply. → Replace batteries

7.3 Maintenance and cleaning



Service

Regular servicing of your balance by a service technician prolongs its working life. Ask your METTLER TOLEDO dealer for details of servicing options.

Cleaning

Every now and then, clean the weighing pan, draftshield element, draftshield (depending on the model) and housing of your balance using a damp cloth. Your balance is made of high-quality, durable materials and can therefore be cleaned with a standard, mild cleaning agent.



Please observe the following notes

- On no account use cleaning agents, which contain solvents or abrasive ingredients, as this can result in damage to the terminal overlay.
- After working with chemicals, it is advisable to wash or clean the weighing pan and the bottom plate (if draft shield fitted).
- Although all materials are of high quality, corrosion may occur if corrosive substances are deposited on chrome steel for an extended period of time (and if air is excluded, for example by a coating of grease).
- Ensure that no liquid comes into contact with the balance or the AC adapter!
- Never open the balance or AC adapter – they contain no components, which can be cleaned, repaired or replaced by the user.
- Soiled protective covers can be replaced on all balance types (see Optional equipment).



Disposal

In conformance with the European Directive 2002/96/EC on Waste Electrical and Electronic Equipment (WEEE) this device may not be disposed of in domestic waste. This also applies to countries outside the EU, per their specific requirements. Please dispose of this product in accordance with local regulations at the collecting point specified for electrical and electronic equipment.

If you have any questions, please contact the responsible authority or the distributor from which you purchased this device.

Should this device be passed on to other parties (for private or professional use), the content of this regulation must also be related.

Thank you for your contribution to environmental protection.

7.4 Declaration of conformity

The undersigned declare on behalf of

Mettler-Toledo AG
Im Langacher
CH-8606 Greifensee

that the balances **METTLER TOLEDO EL... / EL...-IC** to which this declaration relates (serial number specified on the product) are in compliance with the below mentioned EEC Directives (including all amendments)

73/23/EEC Low Voltage Directive

89/336/EEC Electromagnetic compatibility

and that following standards have been applied

IEC/EN61010-1:2001,

EN61326:1997+ A1:98+A2:01+A3:03 (class B)

EN61326:1997+ A1:98+A2:01+A3:03 (Minimal requirements)

for Canada, USA and Australia

CAN/CSA-C22.2 No.61010-1-04, UL Std. No.61010A-1, FCC, Part 15, class A,

AS/NZS CISPR 22, AS/NZS 61000.4.3

Greifensee, 03.10.2007

Mettler-Toledo AG
Laboratory & Weighing Technologies

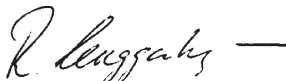

René Lenggenhager
General Manager



Marcel Stroz
Manager SBU LAB Basic Weighing

**To protect your METTLER TOLEDO product's future:
METTLER TOLEDO Service assures the quality, measuring accuracy
and preservation of value of all METTLER TOLEDO products for years to
come.**

Please send for full details about our attractive terms of service.

Thank you.



*** 1 1 7 8 0 8 5 4 ***

Subject to technical changes and to the availability
of the accessories supplied with the instruments.