

# Operation Manual Conductivity/Resistivity Transmitter M300





# **Operation Manual Conductivity/Resistivity Transmitter M300**

## Index

<b>1</b>	<b>Introduction</b>	<b>7</b>
<b>2</b>	<b>Safety instructions</b>	<b>7</b>
2.1	Definition of equipment and documentation symbols and designations	7
2.2	Correct disposal of the unit	8
<b>3</b>	<b>Unit overview</b>	<b>9</b>
3.1	Overview 1/4DIN	9
3.2	Overview 1/2DIN	10
3.3	Control/navigation keys	11
3.3.1	Menu structure	11
3.3.2	Navigation keys	11
3.3.2.1	Navigating the menu tree	11
3.3.2.2	Escape	12
3.3.2.3	Enter	12
3.3.2.4	Menu	12
3.3.2.5	Calibration mode	12
3.3.2.6	Info mode	12
3.3.3	Navigation of data entry fields	12
3.3.4	Entry of data values, selection of data entry options	12
3.3.5	Navigation with ↑ in Display	13
3.3.6	"Save changes" dialog	13
3.4	Display	13
<b>4</b>	<b>Installation instruction</b>	<b>14</b>
4.1	Unpacking and inspection of equipment	14
4.1.1	Panel cutout dimensional information - 1/4DIN models	14
4.1.2	Installation procedure - 1/4DIN models	15
4.1.3	Panel cutout dimensional information - 1/2DIN models	16
4.1.4	Installation procedure - 1/2DIN models	17
4.2	Connection of power supply	18
4.2.1	1/4DIN housing (panel mount)	18
4.2.2	1/2DIN housing (wall mount)	19
4.3	Connector PIN definition	20
4.3.1	TB1 and TB2 for 1/2DIN and 1/4DIN versions	20
4.3.2	TB3 for 1/2DIN and 1/4DIN versions	20
<b>5</b>	<b>Placing transmitter in, or out, of service</b>	<b>21</b>
5.1	Placing transmitter in service	21
5.2	Placing transmitter out of service	21
<b>6</b>	<b>Quick Setup</b>	<b>22</b>
6.1	Sensor Type Selection	22
6.2	Calibration Constant Entry	22
6.3	Measurement Units	22
6.4	Analog Outputs	22
6.5	Setpoint	23
<b>7</b>	<b>Sensor Calibration</b>	<b>24</b>
7.1	Exit Calibration Mode	24
7.2	Enter Calibration Mode	24
7.3	Conductivity/Resistivity Calibration	24
7.3.1	One-point Sensor Calibration	25
7.3.2	Two-point Sensor Calibration	25
7.4	Sensor Temperature Calibration	25
7.4.1	One-Point Sensor Temperature Calibration	26
7.4.2	Two - Point Sensor Temperature Calibration	26
7.5	Edit Sensor Calibration Constants	27
7.6	Sensor Verification	27
<b>8</b>	<b>Configuration</b>	<b>28</b>
8.1	Exit Configuration Mode	28
8.2	Enter Configuration Mode	28
8.3	Measurement	28
8.3.1	Channel Setup	29
8.3.2	Temperature Source	29

	8.3.3	Temperature Compensation (for Mettler Toledo Thornton M300 only)	30
	8.3.4	Set Averaging	31
8.4		Analog Outputs	31
8.5		Setpoints	33
8.6		Alarm/Clean	36
	8.6.1	Alarm	36
	8.6.2	Clean	37
8.7		Display	37
	8.7.1	Measurement	37
	8.7.2	Resolution	38
	8.7.3	Backlight	38
	8.7.4	Name	38
8.8		Hold Analog Outputs	39
<b>9</b>	<b>System</b>		<b>40</b>
9.1		Set Language	40
9.2		USB	40
9.3		Passwords	41
	9.3.1	Changing Passwords	41
	9.3.2	Configuring Menu Access for Operator	41
9.4		Set/Clear Lockout	41
9.5		Reset	42
	9.5.1	Reset System	42
	9.5.2	Reset Meter Calibration	42
	9.5.3	Reset Analog Calibration	42
<b>10</b>	<b>PID Setup</b>		<b>43</b>
10.1		Enter PID Setup	44
10.2		PID Auto/Manual	44
10.3		Mode	45
	10.3.1	PID Mode	45
10.4		Tune Parameters	45
	10.4.1	PID Assignment & Tuning	46
	10.4.2	Setpoint & Deadband	46
	10.4.3	Proportional Limits	46
	10.4.4	Corner Points	46
10.5		PID Operation	46
<b>11</b>	<b>Service</b>		<b>47</b>
11.1		Diagnostics	47
	11.1.1	Software Revision	47
	11.1.2	Digital Input	48
	11.1.3	Display	48
	11.1.4	Keypad	48
	11.1.5	Memory	49
	11.1.6	Set Relay	49
	11.1.7	Read Relays	49
	11.1.8	Set Analog Outputs	50
	11.1.9	Read Analog Outputs	50
11.2		Calibrate	51
	11.2.1	Calibrate Meter	51
	11.2.2	Calibrate Analog	53
	11.2.3	Calibrate Unlock	54
11.3		Tech Service	54
<b>12</b>	<b>Info</b>		<b>55</b>
12.1		Messages	55
12.2		Calibration Data	56
12.3		Model/Software Revision	56
<b>13</b>	<b>Maintenance</b>		<b>57</b>
13.1		For Technical Support	57
13.2		Front Panel Cleaning	57
<b>14</b>	<b>Troubleshooting</b>		<b>57</b>
14.1		Changing the Fuse	58

---

<b>15</b>	<b>Accessories and Spare Parts</b>	<b>58</b>
<b>16</b>	<b>Specifications</b>	<b>59</b>
16.1	General specifications	59
16.2	Electrical specifications for 1/2DIN and 1/4DIN versions	59
16.3	Mechanical specifications for 1/4DIN version	60
16.4	Mechanical specifications for 1/2DIN version	60
16.5	Environmental specifications for 1/2DIN and 1/4DIN versions	60
<b>17</b>	<b>Default tables</b>	<b>61</b>
<b>18</b>	<b>Waranty</b>	<b>62</b>
<b>19</b>	<b>UL Statement (Pending)</b>	<b>62</b>

# 1 Introduction

Statement of Intended Use - The M300 Conductivity/resistivity transmitter is a single-channel online process instrument for measuring conductivity or resistivity of fluids. It will interface with a variety of different Mettler-Toledo sensors, which connect to the transmitter using cables of varied lengths.

A large four line backlit Liquid Crystal Display conveys measuring data and setup information. The menu structure allows the operator to modify all operational parameters by using keys on the front panel. A menu-lockout feature, with password protection, is available to prevent the unauthorized use of the meter. The M300 transmitter can be configured to use its two analog and/or four relay outputs for process control.

The M300 transmitter is equipped with a USB communication interface. This interface provides real-time data output and complete instrument configuration capabilities for central monitoring via Personal Computer (PC).

## 2 Safety instructions

This manual includes safety information with the following designations and formats.

### 2.1 Definition of equipment and documentation symbols and designations

**WARNING:** POTENTIAL FOR PERSONAL INJURY.

**CAUTION:** possible instrument damage or malfunction.



**NOTE:** Important operating information.



On the transmitter or in this manual text indicates: Caution and/or other possible hazard including risk of electric shock (refer to accompanying documents)

The following is a list of general safety instructions and warnings. Failure to adhere to these instructions can result in damage to the equipment and/or personal injury to the operator.

- The M300 Transmitter should be installed and operated only by personnel familiar with the transmitter and who are qualified for such work.
- The M300 Transmitter must only be operated under the specified operating conditions (see section 8).
- Repair of the M300 Transmitter must be performed by authorized, trained personnel only.
- With the exception of routine maintenance, cleaning procedures or fuse replacement, as described in this manual, the M300 Transmitter must not be tampered with or altered in any manner.
- Mettler-Toledo accepts no responsibility for damage caused by unauthorized modifications to the transmitter.
- Follow all warnings, cautions, and instructions indicated on and supplied with this product.
- Install equipment as specified in this instruction manual. Follow appropriate local and national codes.
- Protective covers must be in place at all times during normal operation.
- If this equipment is used in a manner not specified by the manufacturer, the protection provided by it against hazards may be impaired.

#### **WARNINGS:**

Installation of cable connections and servicing of this product require access to shock hazard voltage levels. Main power and relay contacts wired to separate power source must be disconnected before servicing. Main power must employ a switch or circuit breaker as the disconnecting device for the equipment. Electrical installation must be in accordance with the National Electrical Code and/or any other applicable national or local codes.



**RELAY CONTROL ACTION:** the M300 transmitter relays will always de-energize on loss of power, equivalent to normal state, regardless of relay state setting for powered operation. Configure any control system using these relays with fail-safe logic accordingly.



**PROCESS UPSETS:** Because process and safety conditions may depend on consistent operation of this transmitter, provide appropriate means to maintain operation during sensor cleaning, replacement or sensor or instrument calibration.

## **2.2 Correct disposal of the unit**

When the transmitter is finally removed from service, observe all local environmental regulations for proper disposal.



### 3 Unit overview

M300 models are available in both a 1/4DIN and 1/2DIN case size. The 1/4DIN is a panel-mount only design and the 1/2DIN models provides an integral NEMA 4X/IP65 housing for wall-, pipe- or panel-mount.

#### 3.1 Overview 1/4DIN

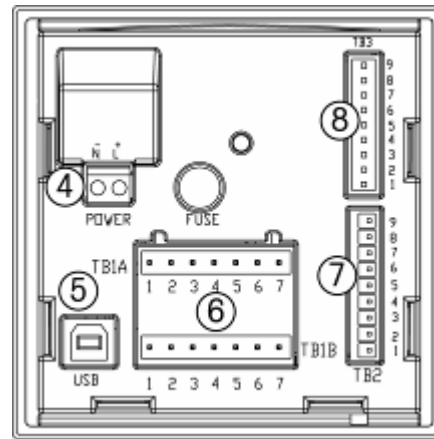
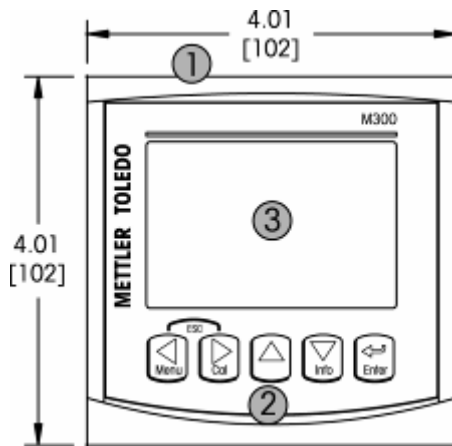

- 1 – Hard Polycarbonate case
- 2 – Five Tactile-Feedback Navigation Keys
- 3 – Four-line LCD Display
- 4 – Power Supply Terminals
- 5 – USB Interface Port
- 6 – Relay Output Terminals
- 7 – Analog Output/Digital Input Terminals
- 8 – Sensor Input Terminals

### 3.2 Overview 1/2DIN

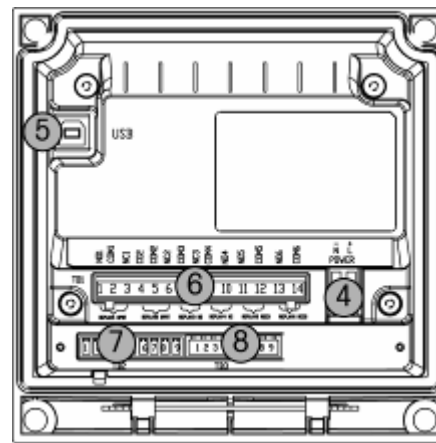
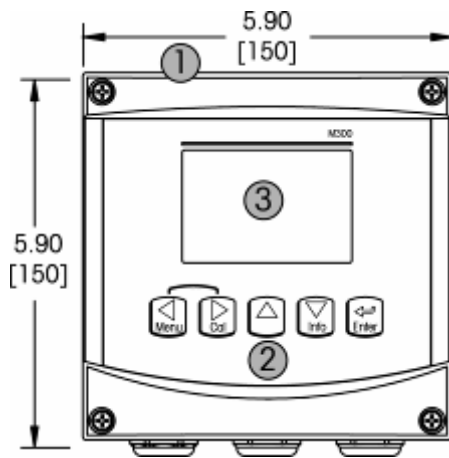

- 1 – Hard Polycarbonate case
- 2 – Five Tactile-Feedback Navigation Keys
- 3 – Four-line LCD Display
- 4 – Power Supply Terminals
- 5 – USB Interface Port
- 6 – Relay Output Terminals
- 7 – Analog Output/Digital Input Terminals
- 8 – Sensor Input Terminals

### 3.3 Control/navigation keys

#### 3.3.1 Menu structure



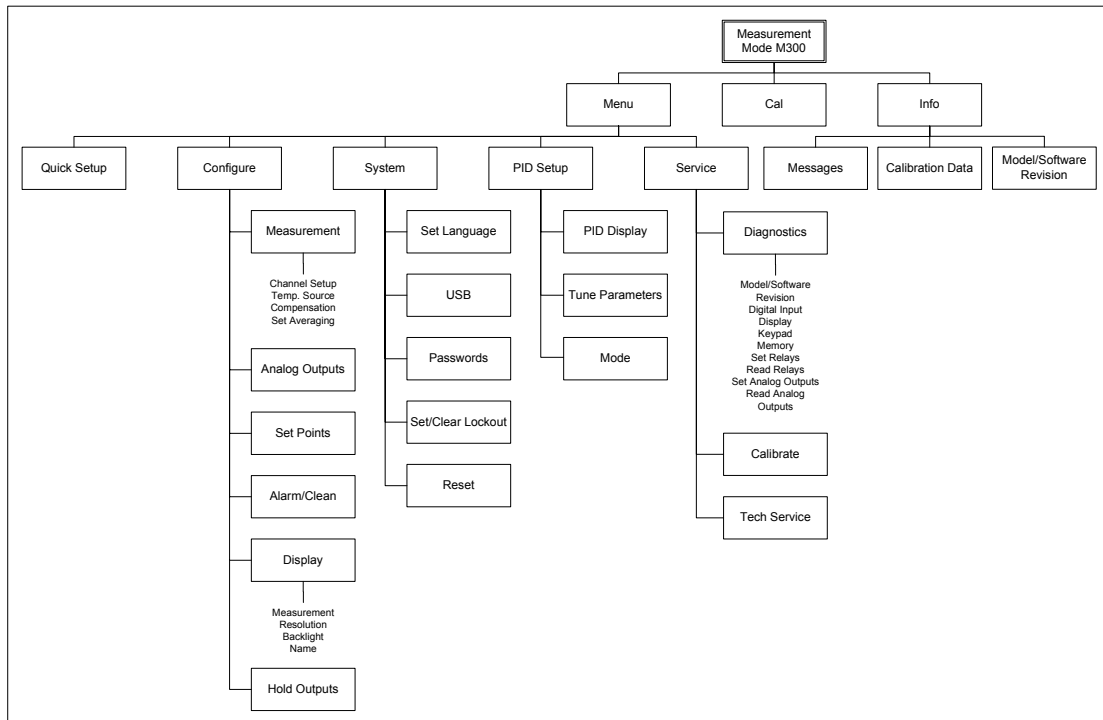

Below is the structure of the M300 menu tree:

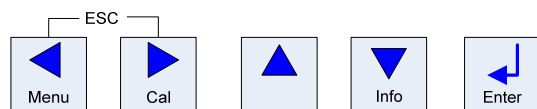

#### 3.3.2 Navigation keys





##### 3.3.2.1 Navigating the menu tree

Enter the desired main Menu branch with the ,  or  keys. Use the  and  keys to navigate through the selected Menu branch.



**NOTE:** In order to back up one menu page, without escaping to the measurement mode, move the cursor under the UP Arrow character at the bottom right of the display screen and press Enter.

### 3.3.2.2 Escape

Press the  and  key simultaneously (escape) to return to the Measurement mode.

### 3.3.2.3 Enter

Use the  key to confirm action or selections.

### 3.3.2.4 Menu

Press the  key to access the main Menu.



### 3.3.2.5 Calibration mode

Press the  key to enter Calibration Mode.



### 3.3.2.6 Info mode

Press the  key to enter Info Mode





## 3.3.3 Navigation of data entry fields

Use the  key to navigate forward or the  key to navigate backwards within the changeable data entry fields of the display.



## 3.3.4 Entry of data values, selection of data entry options

Use the  key to increase or the  key to decrease a digit. Use the same keys to navigate within a selection of values or options of a data entry field.



NOTE: Some screens require configuring multiple values via the same data field (ex: configuring multiple setpoints). Be sure to use the  or  key to return to the primary field and the  or  key to toggle between all configuration options before entering to the next display screen.

### 3.3.5 Navigation with ↑ in Display

If a ↑ is displayed on the bottom right hand corner of the display, you can use the  or the  key to navigate to it. If you click [Enter] you will navigate backwards through the menu (go back one screen). This can be a very useful option to move back up the menu tree without having to exit into the measuring mode and re-enter the menu.

### 3.3.6 "Save changes" dialog

Three options are possible for the "Save changes" dialog: Yes & Exit (Save changes and exit to measuring mode), "Yes & ↑" (Save changes and go back one screen) and "No & Exit" (Don't save changes and exit to measuring mode). The "Yes & ↑" option is very useful if you want to continue configuring without having to re-enter the menu.

## 3.4 Display



**NOTE:** In the event of an alarm or other error condition the M300 Transmitter will display a flashing



in the upper right corner of the display. This symbol will remain until the condition that caused it has been cleared.



**NOTE:** During calibrations with an Analog Output hold, a flashing H will appear in the upper left corner of the display. This symbol will remain for 20 seconds until after the calibration is completed.

## 4 Installation instruction

### 4.1 Unpacking and inspection of equipment

Inspect the shipping container. If it is damaged, contact the shipper immediately for instructions. Do not discard the box.

If there is no apparent damage, unpack the container. Be sure all items shown on the packing list are present. If items are missing, notify Mettler-Toledo immediately

#### 4.1.1 Panel cutout dimensional information - 1/4DIN models

1/4DIN Model transmitters are designed for panel-mount installation only. Each transmitter is supplied with mounting hardware to provide fast and simple installation to a flat panel or flat enclosure door. To insure a good seal and maintain Nema/IP integrity of installation, panel or door must be flat and have a smooth finish. Hardware consists of:

- Two – Snap-on Mounting brackets
- One – Mounting gasket seal

Transmitter dimensions and mounting shown in figure below.

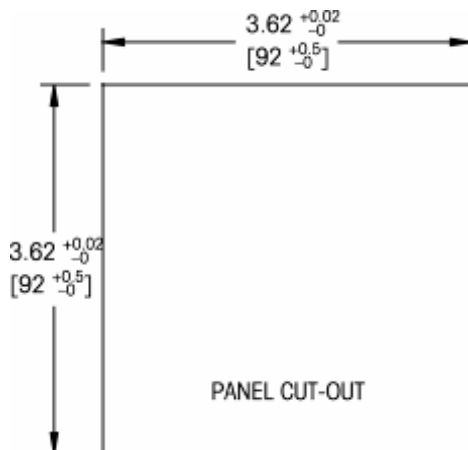

### 4.1.2 Installation procedure - 1/4DIN models

- Make cutout in panel (see dimensions cutout drawing).
- Be sure surface surrounding cutout is clean, smooth and free of burrs.
- Slide face gasket (supplied with transmitter) around transmitter from the back of the unit.
- Place transmitter into cutout hole. Be sure there are no gaps between the transmitter and panel surface.
- Place the two mounting brackets on either side of the transmitter as shown
- While holding transmitter firmly into the cutout hole, push the mounting brackets toward the backside of panel
- Once secure, use a screwdriver to tighten the brackets against the panel
- Face gasket will compress between transmitter and panel
- Do not overtighten brackets

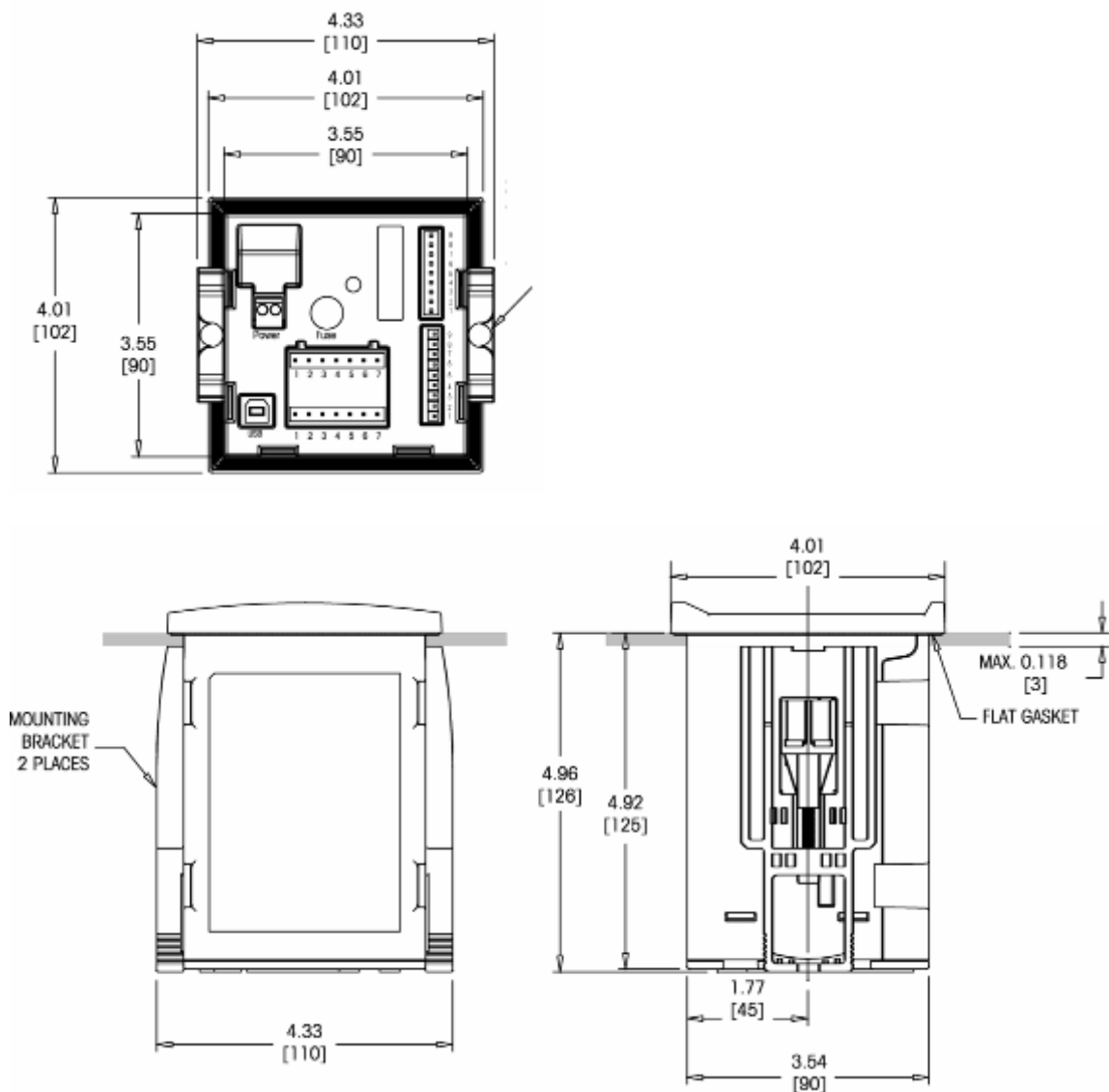

### 4.1.3 Panel cutout dimensional information - 1/2DIN models

1/2DIN Model transmitters are designed with an integral rear cover for stand-alone wall mount installation. The unit may also be wall mounted using the integral rear cover. See installation instructions in Section 4.1.4.

Below are cut-out dimensions required by the 1/2DIN models when mounted within a flat panel or on a flat enclosure door. This surface must be flat and smooth. Textured or rough surfaces are not recommended and may limit the effectiveness of the gasket seal provided.

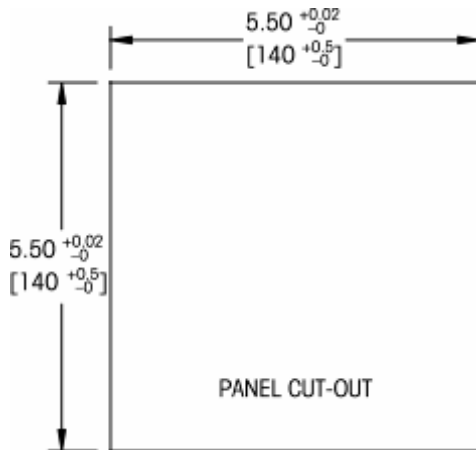

Optional hardware accessories are available that allow for panel- or pipe-mount. Refer to Section 15 for ordering information.



#### 4.1.4 Installation procedure - 1/2DIN models

- Remove rear cover from front housing.
- Start by unscrewing the four screws located on the face of the transmitter, in each corner. This allows the front cover to swing away from the rear housing.
- Remove the hinge-pin by squeezing the pin from each end. This allows the front housing to be removed from the rear housing.
- Drill out wall-mount breakthroughs in the rear housing. This is also a good time to drill out cable gland holes for power, sensor and interface cables.
- Mount rear housing to wall using appropriate mounting hardware for wall surface. Be sure it is level and securely fastened and the installation adheres to any and all clearance dimensions required for transmitter service and maintenance.
- Replace the front housing to the rear housing. The unit is ready to be wired.

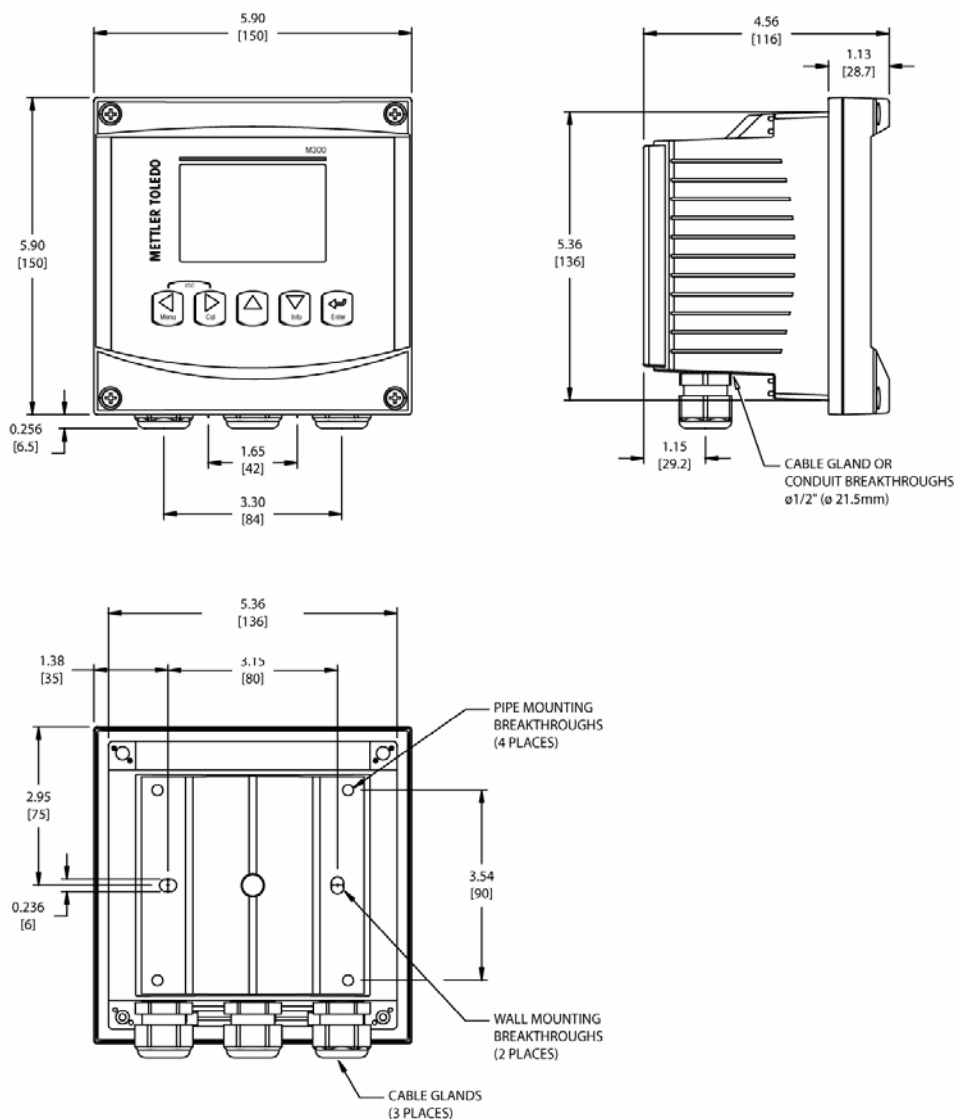

## 4.2 Connection of power supply

All connections to the transmitter are made on the rear panel of all models.



Be sure power to all wires is turned off before proceeding with the installation. High voltage may be present on the input power wires and relay wires.

A two-terminal connector on the rear panel of all M300 models is provided for power connection. All M300 models are designed to operate from a 20-30 VDC or a 100 to 240 VAC power source. Refer to specifications for power requirements and ratings and size power wiring accordingly.

The terminal block for power connections is labeled "Power" on the rear panel of the transmitter. One terminal is labeled **- N** for the Neutral wire and the other **+L** for the Line (or Load) wire. There is no earth ground terminal on the transmitter. For this reason the internal power wiring within the transmitter is double insulated and the product label designates this using the  symbol.

### 4.2.1 1/4DIN housing (panel mount)

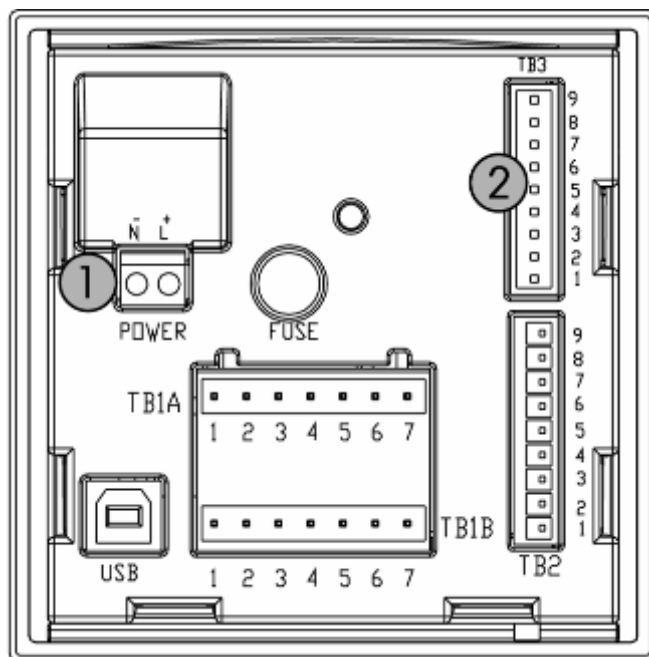

- 1 Connection of power supply
- 2 Terminal for sensor

#### 4.2.2 1/2DIN housing (wall mount)

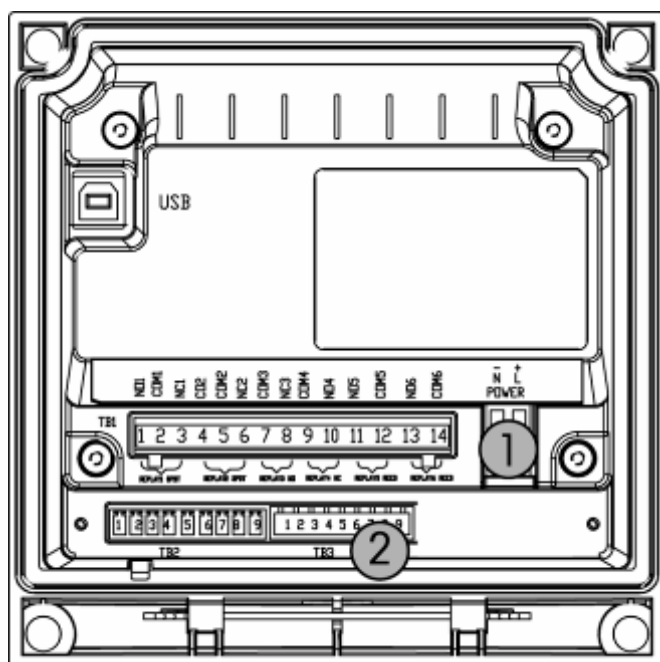

- 1 Connection of power supply
- 2 Terminal for sensor

### 4.3 Connector PIN definition

#### 4.3.1 TB1 and TB2 for 1/2DIN and 1/4DIN versions

**¼ DIN**

TB2 for ¼ DIN	
1	AO1+
2	AO1-/AO2-
3	AO2+
4	-
5	-
6	-
7	DI1+
8	DI1-
9	-

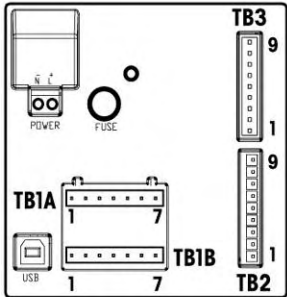

TB1A for ¼ DIN	
1	NO2
2	COM2
3	NC2
4	-
5	-
6	NO4
7	COM4

TB1B for ¼ DIN	
1	NO1
2	COM1
3	NC1
4	-
5	-
6	NO3
7	COM3

**½ DIN**

TB2 for ½ DIN	
1	AO1+
2	AO1-/AO2-
3	AO2+
4	-
5	-
6	-
7	DI1+
8	DI1-
9	-

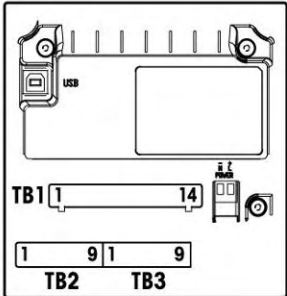

TB1 for ½ DIN			
1	NO1	8	-
2	COM1	9	-
3	NC1	10	-
4	NO2	11	NO3
5	COM2	12	COM3
6	NC2	13	NO4
7	-	14	COM4

NO=normally open (contact is open if unactuated). NC=normally closed (contact is closed if unactuated).

#### 4.3.2 TB3 for 1/2DIN and 1/4DIN versions

TB3 is used for wiring Two & Four Electrode Conductivity Sensors (including Thornton 240-xxx, 243-xxx and 244-xxx Series)

Pin no.	Sensor wire Color	Transmitter
1	white	Cnd inner 1
2	white/blue	Cnd outer 1
3	blue	Cnd inner 2
4	black & bare shield	Cnd outer 2/ Shield
5	-	not used
6	clear	RTD ret/GND
7	red	RTD sense
8	green	RTD
9	-	+5V

## 5 Placing transmitter in, or out, of service

### 5.1 Placing transmitter in service



After connecting the transmitter to power supply circuit, it will be active as soon as the circuit is powered.

### 5.2 Placing transmitter out of service

First disconnect the unit from the main power source, then disconnect all remaining electrical connections. Remove the unit from the wall / panel. Use the installation instruction in this manual as reference for disassembling mounting hardware.

## 6 Quick Setup

(PATH: Menu/Quick Setup)

While in Measurement mode press the [MENU] key to bring up the Menu selection. Select Quick Setup and press the [ENTER] key.

Convention:

1<sup>st</sup> line on display => a

2<sup>nd</sup> line on display => b

3<sup>rd</sup> line on display => c

4<sup>th</sup> line on display => d

Only lines a and b can be configured in Quick Setup. Go to the Configuration Menu to configure lines c and d.

### 6.1 Sensor Type Selection

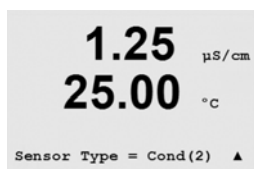

Select the type of sensor to be used with the M300 transmitter. Choices are 'Cond(2)', used for all 2-Electrode type sensors and 'Cond (4)' for all 4-electrode Sensors. Press [ENTER].

### 6.2 Calibration Constant Entry

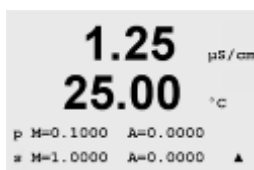

Enter the calibration constants from the sensor label or certificate. Conductivity cell constants are primary 'p'. For 2-electrode sensors, leave A = 0.0000. Temperature constants are secondary 's'.

### 6.3 Measurement Units



Select a or b and select the units of measurement. Example:

By selecting a and S/cm as unit, the conductivity value will be displayed on the 1<sup>st</sup> line. By selecting b and Ω-cm as unit, the resistivity value will be displayed on the 2<sup>nd</sup> line of the display. By selecting a and °C as unit, the temperature will be displayed on the 1<sup>st</sup> line. By selecting b and °C as unit, the temperature will be displayed on the 2<sup>nd</sup> line.

### 6.4 Analog Outputs

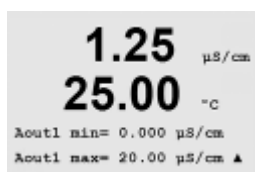

On the same screen above, by selecting Yes the linear 4-20 mA analog output Aout1 will be set up when Enter is pressed. Selecting No means that no analog output is set up.

Aout1 min, Aout1 max are the minimum and maximum measurement values for the 4 and 20mA values respectively. Be sure to enter the correct unit multiplier (μ, m, K, M). To configure output 2, use the Configuration Menu. Press [ENTER].

## 6.5 Setpoint



After configuring the Analog Output, a Setpoint can be configured for that measurement. If No is selected and [ENTER] is pressed then the quick setup is done and the menus are exited without setting up any Setpoint. To establish a Setpoint for channel a, select Yes and select one of the following Setpoint Types:

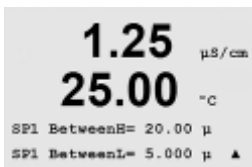

High (High value has to be set)  
 Low (Low value has to be set)  
 Between (High and Low value has to be set)  
 Outside (High and Low value has to be set)  
 Setpoints for Mettler Toledo Thornton M300 only:  
 USP (% safety margin below U.S. Pharmacopoeia limits)  
 EP PW (% safety margin below European Pharmacopoeia limits for Purified Water)  
 EPWFI (% safety margin below European Pharmacopoeia limits for Water for Injection)



After setting the Setpoint value(s) and its units multiplier, e.g.  $\mu$ , m, K, M, select a Relay (none, 1, 2, 3, 4) for that Setpoint. The Relay delay is set to 10 seconds and the Hysteresis is set to 5%. Press [ENTER].

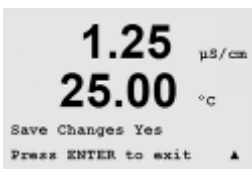

If [ENTER] is pressed again the Setpoint setup is stored and any previous use of the relay is cancelled. If No is selected then the menu is exited without saving the entered settings.



## 7 Sensor Calibration

(PATH: Cal)

The calibration key  allows the user one-touch access to sensor calibration and verification features. When performing calibration on a conductivity or resistivity sensor, results will vary depending on the methods, calibration apparatus and/or quality of reference standards used to perform the calibration.

### 7.1 Exit Calibration Mode





Note: to exit Calibration mode at any time press the  and  key simultaneously (ESC). The transmitter returns to the Measurement mode and the old calibration values remain active.

### 7.2 Enter Calibration Mode



While in Measurement mode press the  key.

Press the  or  key to select the type of calibration desired. The options are 'Meter', 'Analog', and 'Sensor'.

After selecting 'Sensor', press Enter and the cursor moves to the next line to select the desired Sensor Calibration task, The choices are 'Conductivity', 'Resistivity', 'Temperature', 'Edit' and 'Verify'. A flashing 'H' in the upper left corner of the display indicates a calibration is in process with a Hold condition active.



After selecting the desired sensor calibration and pressing Enter, the next screen will ask to select the type of temperature compensation mode desired during the calibration process. The choices are 'None', 'Standard', 'Light 84', 'Std 75°C', 'Linear = 02.0%/°C' (user selectable value), 'Glycol.5', 'Glycol1', and 'Alcohol'.

### 7.3 Conductivity/Resistivity Calibration

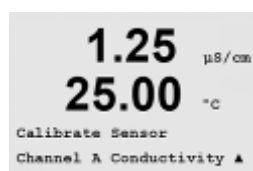

This feature provides the ability to perform a one-point or two-point Conductivity or Resistivity 'Sensor' calibration. The procedure described below works for both types of calibrations. There is no reason to perform a two-point calibration on a two-electrode conductivity sensor. Four electrode sensors do require a two-point calibration. It is also not practical to calibrate resistivity sensors using (low conductivity) reference solutions. It is recommended that resistivity sensors be sent back to the factory for calibration. Consult factory for assistance.



### 7.3.1 One-point Sensor Calibration

1.25  $\mu\text{S}/\text{cm}$   
25.00  $^{\circ}\text{C}$   
Conductivity Calibration  
Type = 1 point  $\blacktriangleright$

(Display reflects typical Conductivity Sensor calibration)

Select 1 point Calibration by pressing the [ENTER] key.

1.25  $\mu\text{S}/\text{cm}$   
25.00  $^{\circ}\text{C}$   
Point1 = 1.4180  $\mu\text{S}/\text{cm}$   
C = 1.2500  $\mu\text{S}/\text{cm}$   $\blacktriangleright$

Enter the Value of calibration Point 1 and then press the [ENTER] key to start calibration. The value in the 2<sup>nd</sup> text line is the actual measured value from the sensor prior to calibration.

1.25  $\mu\text{S}/\text{cm}$   
25.00  $^{\circ}\text{C}$   
C M=0.10092 A=0.00000  
Save Calibration Yes  $\blacktriangleright$

After the calibration the Multiplier or slope calibration factor 'M' and the Adder or offset calibration factor 'A' are displayed.

Select Yes to save the calibration values and the successful Calibration is confirmed on the display.

### 7.3.2 Two-point Sensor Calibration

1.25  $\mu\text{S}/\text{cm}$   
25.00  $^{\circ}\text{C}$   
Conductivity Calibration  
Type = 2 point  $\blacktriangleright$

Enter Sensor Calibration mode as described in section 7.2.

Select 2 point Calibration by pressing the  followed by the [ENTER] key.

1.25  $\mu\text{S}/\text{cm}$   
25.00  $^{\circ}\text{C}$   
Point1 = 1.4180  $\mu\text{S}/\text{cm}$   
C = 1.2500  $\mu\text{S}/\text{cm}$   $\blacktriangleright$

Enter the Value of Point 1 and then press the [ENTER] key. Place the sensor into the second reference solution.

Enter the Value of Point 2 and then press the [ENTER] key to start the calibration.

1.25  $\mu\text{S}/\text{cm}$   
25.00  $^{\circ}\text{C}$   
C M=0.10000 A=0.00000  
Save Calibration Yes  $\blacktriangleright$

After the calibration the Multiplier or slope calibration factor 'M' and the Adder or offset calibration factor 'A' are displayed.

Select Yes to save the net calibration values and the successful Calibration is confirmed on the display.

## 7.4 Sensor Temperature Calibration

1.25  $\mu\text{S}/\text{cm}$   
25.00  $^{\circ}\text{C}$   
Calibrate Sensor  
Channel A Temperature  $\blacktriangleright$

Enter Sensor Calibration mode as described in section 7.2. and select Temperature.

### 7.4.1 One-Point Sensor Temperature Calibration



See 7.4 on how to enter the Temperature Calibration menu. Slope or Offset can be selected with the 1 point calibration. Select Slope to recalculate the Slope factor M (Multiplier) or Offset to recalculate the offset calibration factor A (Adder).

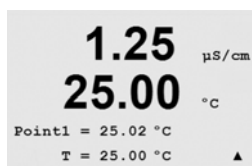

Enter the value for Point 1 and press [ENTER].

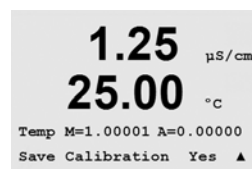

The newly calculated value – either M or A – is displayed. Select Yes to save the new calibration values and the successful Calibration is confirmed on the display.

### 7.4.2 Two - Point Sensor Temperature Calibration

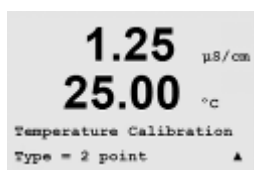

See 7.4 on how to enter the Temperature Calibration menu. Select 2 point as calibration Type.

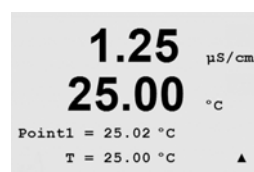

Enter the value for Point 1 and press [ENTER].



Enter the value for Point 2 and press [ENTER].

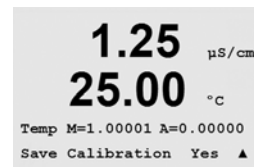

The newly calculated values M and A are displayed. Select Yes and press [ENTER] to save the new calibration values and the successful Calibration is confirmed on the display.

## 7.5 Edit Sensor Calibration Constants



Enter Calibration mode as described in section 7.2 and select Edit.

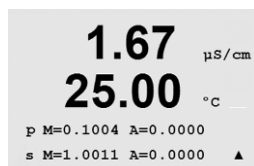

All calibration constants of the primary measurement (p) for the sensor are displayed on Line 3. All calibration constants of the secondary measurement (s) for the sensor are displayed on Line 4. For conductivity and resistivity sensors, the (p) primary measurement is conductivity or resistivity and the (s) secondary measurement is temperature.

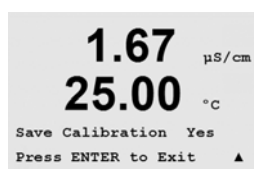

The calibration constants can be changed in this menu.

Select Yes to save the new calibration values and the successful Calibration is confirmed on the display.

## 7.6 Sensor Verification

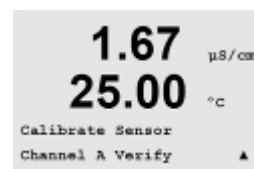

Enter Calibration mode as described in section 7.2. and select Verify.

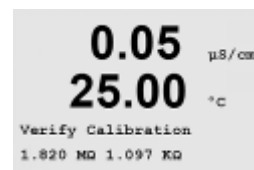

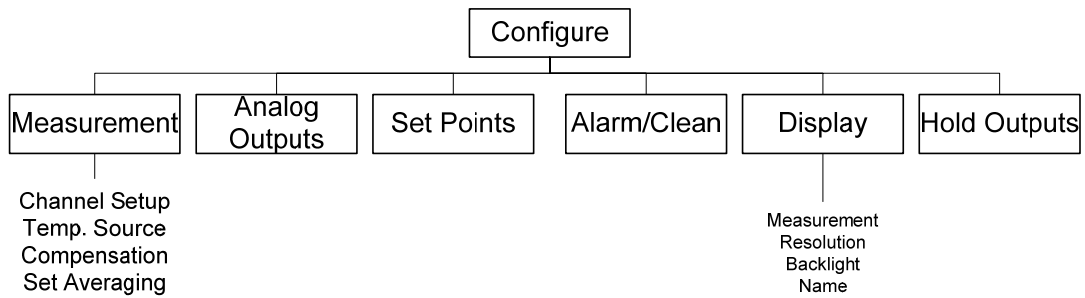

The measured resistance of the primary (Conductivity or Resistivity) measurement and the secondary (Temperature) measurement are shown. The meter calibration factors are used when calculating these values.

## 8 Configuration





### 8.1 Exit Configuration Mode



Note: to exit Configuration mode at any time press the  and  key simultaneously (ESC). The transmitter returns to the Measurement mode and the old settings remain active.

### 8.2 Enter Configuration Mode



While in Measurement mode press the  key. Press the  or  key to navigate to the Configure – Menu. After selecting the Configure – Menu enter the configuration security code and then press the [ENTER] key to confirm the code.

### 8.3 Measurement

(Menu/Configure/Measurement)



Press the [ENTER] key to select this Menu. The following sub menus can now be selected: Channel Setup, Temperature Source, Compensation and Set Averaging

### 8.3.1 Channel Setup

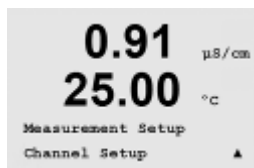

Press the [ENTER] key to select the 'Channel setup' Menu.

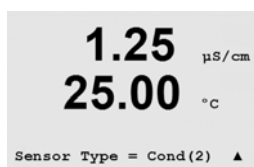

Select Sensor Type (2- or 4-electrode) and press [ENTER].

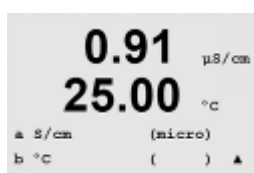

The 4 lines of the display can now be configured with measurements. Pressing the [ENTER] key will display the selection for lines c and d.

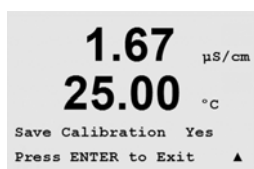

Pressing the [ENTER] key again will bring up the Save Changes dialog. Selecting No will discard the entered values and return to the measurement display screen, selecting Yes will save changes made.

### 8.3.2 Temperature Source



Press the [ENTER] key to select this Menu. The following options can be chosen: 'Fixed' or 'Use this channel'.

Fixed: allows a specific temperature value to be entered.

Use this channel: temperature input will be taken from the sensor attached.

### 8.3.3 Temperature Compensation (for Mettler Toledo Thornton M300 only)

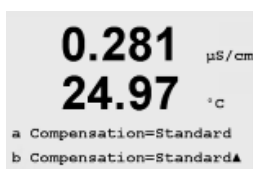
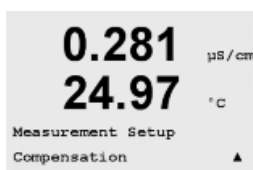

Press [ENTER] to select this Menu. The temperature compensation mode for any of the four measurement lines can be selected. Temperature compensation should be matched to the characteristics of the application. Choices are 'None', 'Standard', 'Light 84', 'Std 75°C', 'Linear', 'Glycol.5', 'Glycol1', 'Cation', 'Alcohol', and 'Ammonia'. Press [ENTER] and save changes.

Standard compensation includes compensation for non-linear high purity effects as well as conventional neutral salt impurities and conforms to ASTM standards D1125 and D5391.

Std 75°C compensation is the Standard compensation algorithm referenced to 75°C. This compensation may be preferred when measuring Ultrapure Water at an elevated temperature. (Resistivity of ultrapure water compensated to 75°C is 2.4818 Mohm-cm.)

Linear compensation adjusts the reading by a factor expressed as a "% per °C" (deviation from 25°C). Use only if the sample has a well-characterized linear temperature coefficient. The factory default setting is 2.0%/°C.

Glycol.5 compensation matches the temperature characteristics of 50% ethylene glycol in water. Compensated measurements using this solution may go above 18 Mohm-cm.

Glycol1 compensation matches the temperature characteristics of 100% ethylene glycol. Compensated measurements may go well above 18 Mohm-cm.

Cation compensation is used in power industry applications measuring the sample after a cation exchanger. It takes into account the effects of temperature on the dissociation of pure water in the presence of acids.

Alcohol compensation provides for the temperature characteristics of a 75% solution of isopropyl alcohol in pure water. Compensated measurements using this solution may go above 18 Mohm-cm.

Light 84 compensation matches the high purity water research results of Dr. T.S. Light published in 1984. Use only if your institution has standardized on that work.

Ammonia compensation is used in power industry applications for specific conductivity measured on samples using ammonia and/or ETA (ethanolamine) water treatment. It takes into account the effects of temperature on the dissociation of pure water in the presence of these bases.

### 8.3.4 Set Averaging

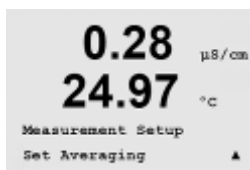

Press the [ENTER] key to select this Menu. The averaging method (noise filter) for each measurement line can now be selected. The options are Special (Default), None, Low, Medium and High:

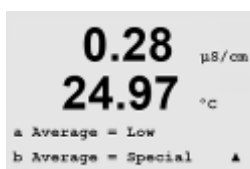

None = no averaging or filtering  
 Low = equivalent to a 3 point moving average  
 Medium = equivalent to a 5 point moving average  
 High = equivalent to a 7 point moving average  
 Special = averaging depending on signal change (normally High averaging but Low averaging for large changes in input signal)

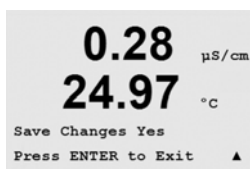

Pressing the [ENTER] key again will bring up the Save Changes dialog. Selecting No will discard the entered values and return to the measurement display screen, selecting Yes will save changes made.

## 8.4 Analog Outputs

(PATH: Menu/Configure/Analog Outputs)



Press the [ENTER] key to select this Menu, which lets you configure the 2 Analog Outputs.



Select the Analog output number 1 or 2 (default is 1), the channel a, b, c, d or blank (none) and the value of 3.6 mA or 22.0 mA or Off (default is off). If either mA value is selected it is this value the analog output will go to if any of the alarm conditions occur

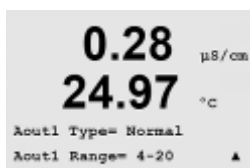

The Aout type can be Normal, Bi-Linear, Auto-Range or Logarithmic. The range can be 4-20mA or 0-20mA. Normal provides linear scaling between the minimum and maximum scaling limits and is the default setting. Bi-Linear will also prompt for a scaling value for the mid-point of the signal and allows two different linear segments between the minimum and maximum scaling limits.

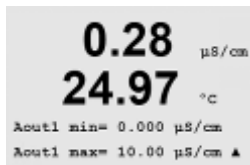

Enter the minimum and maximum Value of Aout.

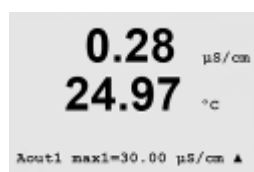

If Auto-range was selected then Aout max1 can be configured. Aout max1 is the maximum value for the first range on Auto-Range. The maximum value for the second range on Auto-Range was set in the previous menu. If Logarithmic Range was selected, it will also prompt for the number of decades as 'Aout1 # of Decades =2'.



The value for the Hold mode can be configured to hold the last value or can be set to a Fixed value.

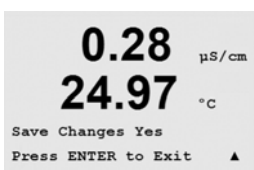

Pressing the [ENTER] key again will bring up the Save Changes dialog. Selecting No will discard the entered values and return to the measurement display screen, selecting Yes will save changes made.



## 8.5 Setpoints

(PATH: Menu/Configure/Setpoints)

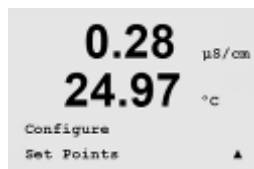

Press the [ENTER] key to select this Menu.



Up to 4 Setpoints can be configured on any of the channels (a thru d). If configuring a setpoint for a channel displaying conductivity measurement, the possible types are Off, High, Low, Outside and Between. Thornton models also include types, %USP, %EP PW and %EP WFI. If configuring a setpoint for a channel displaying temperature, possible types are Off, High, Low, Outside and Between.

An 'Outside' Setpoint will cause an alarm condition whenever the measurement goes above its high limit or below its low limit. A 'Between' Setpoint will cause an alarm condition to occur whenever the measurement is between its high and low limits.

USP and EP Setpoints on Thornton models provide a high alarm used for pharmaceutical water monitoring with non-temperature compensated conductivity measurements. USP (United States Pharmacopoeia) section <645> and European Pharmacopoeia require that non-temperature compensated conductivity of pharmaceutical waters must be below a limit from tables based on the temperature of the sample. In other words, pharmaceutical requirements temperature-compensate the limit rather than the measurement.

The Mettler Toledo Thornton M300 has these pharmaceutical limit tables in memory and automatically determines the conductivity limit based on the measured temperature. USP and EPWFI (Water for Injection) setpoints use Table 8.1. The limit is the conductivity value corresponding to the 5° temperature step immediately below or equal to the measured temperature value. EP *Highly* Purified Water limits are identical to EP WFI limits.

EP PW (Purified Water) setpoints use Table 8.2. The limit in this case is the conductivity value interpolated for the measured temperature. The M300 takes care of this automatically.

The pharmaceutical setpoint *value* entered into the M300 is the percentage safety margin *below* the limits to activate the setpoint. For example, the USP table conductivity limit at 15°C is 1.0 µS/cm. If the setpoint value is set at 40% then the setpoint will activate whenever the conductivity goes above 0.6 µS/cm at 15°C.

Table 8.1: USP Section <645> Stage 1, EP WFI (Water for Injection), and EP Highly Purified Water Conductivity Limits as a Function of Temperature

Temperature (°C)	Conductivity Limit (µS/cm)
0	0.6
5	0.8
10	0.9
15	1.0
20	1.1
25	1.3
30	1.4
35	1.5
40	1.7
45	1.8
50	1.9
55	2.1
60	2.2
65	2.4
70	2.5
75	2.7
80	2.7
85	2.7
90	2.7
95	2.9
100	3.1

Table 8.2: EP PW (Purified Water) Conductivity Limits as a Function of Temperature

Temperature (°C)	Conductivity Limit (µS/cm)
0	2.4
10	3.6
20	4.3
25	5.1
30	5.4
40	6.5
50	7.1
60	8.1
70	9.1
75	9.7
80	9.7
90	9.7
100	10.2



Enter the desired value(s) for the Setpoint and press [ENTER]



This screen provides the option to configure a setpoint to be active on an over range condition. Select the setpoint (1 thru 4) and 'Yes' or 'No'. Select the desired relay that will activate when the setpoint alarm condition is reached.



Set the Relay delay and the Hysteresis of the configured Relay.

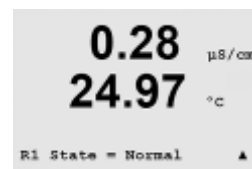

Set the Relay contact State, normal or inverted.

Pressing the [ENTER] key again will bring up the Save Changes dialog. Selecting No will discard the entered values and return to the measurement display screen, selecting Yes will save changes made.

## 8.6 Alarm/Clean

(PATH: Menu/Configure/Alarm/Clean)



This Menu allows the configuration of Alarm and Clean functionality.

### 8.6.1 Alarm



Select the Relay to be used for the Alarm.

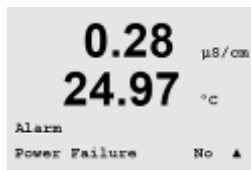

Select any of the following events to be alarmed:

Power failure

Software failure

If any of these are set to yes then the alarm will come on and an alarm message will be recorded if:

there is a power failure or power cycling

the software watchdog timer performs a reset

The alarm indicator will be turned off when the alarm message is cleared. The indicator and message will reappear if the power is cycled again or if the watchdog timer again resets the system.



Configure the chosen Alarm Relay. The state can be Normal or Inverted, also a Delay for the activation can be set.

Pressing the [ENTER] key again will bring up the Save Changes dialog.

Selecting No will discard the entered values and return to the measurement display screen, selecting Yes will save changes made.

## 8.6.2 Clean



Configure the Relay to be used for the cleaning cycle.



The Cleaning Interval can be set from 0.000 to 999.9 hours. Setting it to 0 turns the clean cycle off. The cleaning time can be 0 to 9999 seconds and must be smaller than the Cleaning Interval.



Select the desired Relay state: Normal or Inverted.

Pressing the [ENTER] key again will bring up the Save Changes dialog. Selecting No will discard the entered values and return to the measurement display screen, selecting Yes will save changes made.

## 8.7 Display

(PATH: Menu/Configure/Display)



This Menu allows for the configuration of the values to be displayed and also the configuration of the Display itself.

### 8.7.1 Measurement



The Display has 4 lines. Line 1 on top and Line 4 on the bottom.

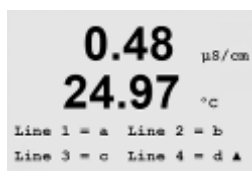

Select the values (channels) to be displayed on each line of the display.

Error Display 'On' causes the message "Failure – Press Enter" to be displayed on Line 4 in the normal measurement mode.



Pressing the [ENTER] key again will bring up the Save Changes dialog. Selecting No will discard the entered values, selecting Yes will make the entered values the current ones.

## 8.7.2 Resolution



This menu allows the setting of the resolution of each displayed value.



Possible settings are 1, 0.1, 0.01, 0.001 or Auto.

Pressing the [ENTER] key again will bring up the Save Changes dialog. Selecting No will discard the entered values, selecting Yes will make the entered values the current ones.

## 8.7.3 Backlight



This Menu allows the setting of the back light options of the display.



Possible settings are On, On 50% or Auto Off 50%. If Auto Off 50% is selected then the backlight will go to 50% after 4 minutes with no keypad activity. The backlight will automatically come back on if a key is pressed.

Pressing the [ENTER] key again will bring up the Save Changes dialog. Selecting No will discard the entered values, selecting Yes will make the entered values the current ones.

## 8.7.4 Name



This menu allows for the configuration of a text which is displayed on Lines 3 and 4 of the Display. Typically this is used as identification for the measurement.



The Name can be alphanumeric and is displayed in the first 9 characters of Line 3 and Line 4 during normal measurement mode. The default is nothing (blank).

## 8.8 Hold Analog Outputs

(PATH: Menu/Configure/Hold Outputs)



This Menu allows configuration of the Hold Outputs status.





Analog outputs will not be held if No is selected. If Yes is selected, Outputs will be held depending of the status of Digital Input # 1. The choices are 'high' or 'low'. All outputs will be held if the digital input is in the selected state. If 'Off' is selected as DI (Digital Input) status, the Digital Input is inactive and the Hold status will not be triggered through an external signal, although the outputs will be held during configuration or calibration procedures as long as the hold Outputs option is 'Yes'..

## 9 System

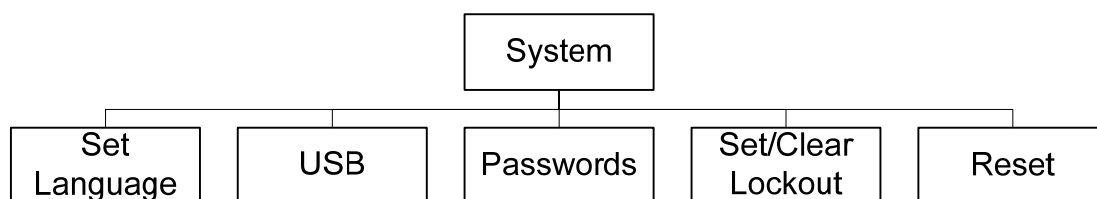
(PATH: Menu/System)



While in Measurement mode press the  key Press the  or  key to navigate to 'System' Menu. After selecting the System, press the [ENTER] key to find the following system configuration options.

### 9.1 Set Language

(PATH: Menu/System/Set Language)

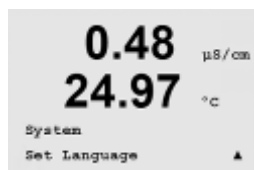

This Menu allows the configuration of the Display language.

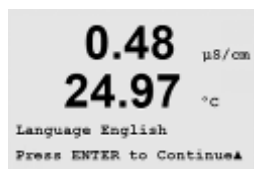

The following selections are possible: English, French, German, Italian and Spanish.

Pressing the [ENTER] key will bring up the Save Changes dialog. Selecting No will discard the entered value, selecting Yes will make the entered value the current one.

### 9.2 USB

(PATH: Menu/System/USB)



This menu allows for the configuration of the USB port



USB Hold can be set to Off or Last Values. This allows the user to select whether or not the USB output will hold the Last value, or continue to output the current value during a Hold Outputs condition.



## 9.3 Passwords

(PATH: Menu/System/Passwords)



This Menu allows for the configuration of Operator and Administrator Passwords, as well as setting up a List of allowed Menus for the Operator. The Administrator has rights to access all Menus. All default passwords for new transmitters are '00000'.

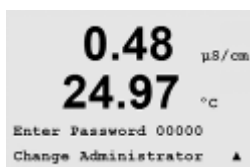

The Passwords Menu is protected: Enter the Administrator Password to enter the Menu.

### 9.3.1 Changing Passwords

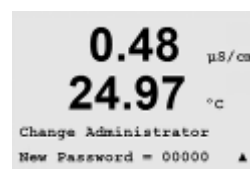

See 9.3 on how to enter the Passwords Menu. Then select Change Administrator or Change Operator to change the appropriate Password and set the new Password. Pressing the [ENTER] key will bring up the Save Changes dialog. Selecting No will discard the entered Password, selecting Yes will make the entered Password the current one.

### 9.3.2 Configuring Menu Access for Operator

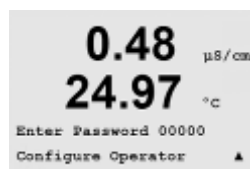

See 9.3 on how to enter the Passwords Menu. Then select Configure Operator to configure the Access list for the Operator. It is possible to assign/deny rights to the following Menu:

Cal Key, Quick Setup, Configuration, System, PID Setup and Service. Choose either Yes or No to give/ deny access to the above Menus and press [ENTER] to advance to the next items. Pressing the [ENTER] key after configuring all menus will bring up the Save Changes dialog. Selecting No will discard the entered values, selecting Yes will make the entered values the current ones.

## 9.4 Set/Clear Lockout

(PATH: Menu/System/Set/Clear Lockout)



The user will be asked for a password before being allowed into any menus if the Lockout functionality is enabled.

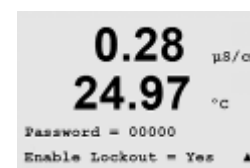

The Lockout – Menu is protected: Enter the Administrator Password and select YES to enable or NO to disable the Lockout functionality. Pressing the [ENTER] key after the selection will bring up the Save Changes dialog. Selecting No will discard the entered value, selecting Yes will make the entered value the current one.

## 9.5 Reset

(PATH: Menu/System/Reset)



This Menu allows for following options:  
Reset System, Reset Meter Cal, Reset Analog Cal.

### 9.5.1 Reset System

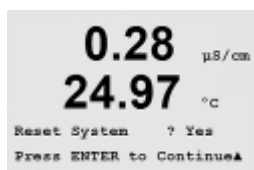

This Menu allows the reset of the meter to the factory default settings (Setpoints off, analog outputs off, etc.). The meter calibration and the analog output calibration are not affected. Pressing the [ENTER] key after the selection will bring up a confirmation screen. Selecting No will discard the entered value, selecting Yes will make the entered value the current one.

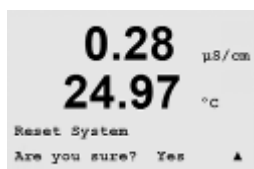

### 9.5.2 Reset Meter Calibration



This Menu allows the reset of the meter's calibration factors to the last factory calibration values.

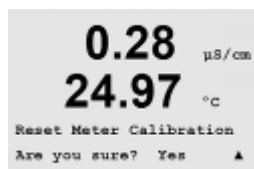

Pressing the [ENTER] key after the selection will bring up a confirmation screen. Selecting No will discard the entered value, selecting Yes will make the entered value the current one.

### 9.5.3 Reset Analog Calibration

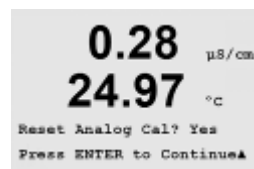

This Menu allows the reset of the Analog Output calibration factors to the last factory calibration values.

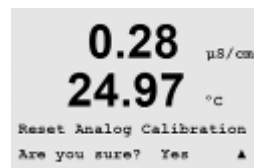

Pressing the [ENTER] key after the selection will bring up a confirmation screen. Selecting No will discard the entered value, selecting Yes will make the entered value the current one.

## 10 PID Setup

(PATH: Menu/PID Setup)

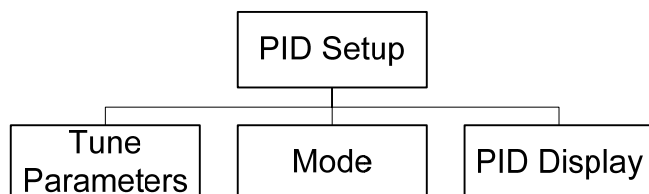

PID control is proportional, integral and derivative control action that can provide smooth regulation of a process. Before configuring the transmitter, the following process characteristics must be identified.

Identify the **control direction** of the process:

Dilution—direct acting where increasing measurement produces increasing control output such as controlling the feed of low conductivity diluting water to cooling towers or boilers

Concentrating—reverse acting where increasing measurement produces decreasing control output, such as controlling chemical feed to attain a desired concentration

Identify the **control output type** based on the control device to be used:

Pulse Frequency—used with pulse input metering pump

Pulse Length—used with solenoid valve

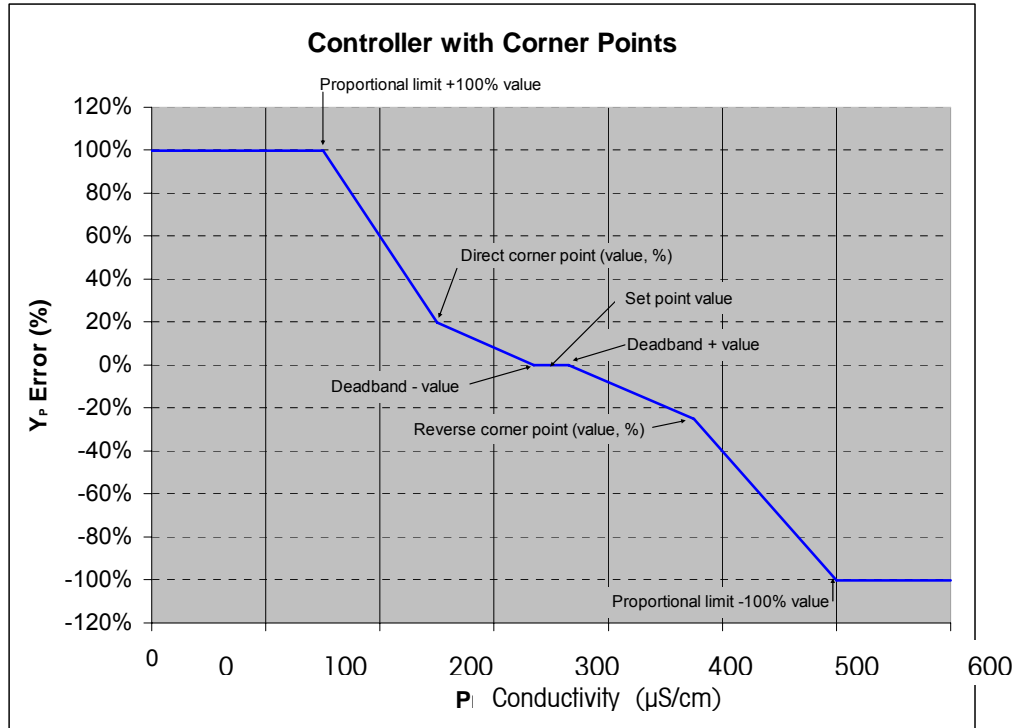

Analog—used with current input device such as electric drive unit, analog input metering pump or current-to-pneumatic (I/P) converter for pneumatic control valve

Default control settings provide linear control which is appropriate for conductivity. The non-linear control settings are used in pH/ORP models of this transmitter. Therefore ignore settings of deadband and corner points in the Tuning Parameter section below.



### 10.1 Enter PID Setup



While in Measurement mode press the  key. Press the  or  key to navigate to the PID Setup – Menu. After selecting the PID Setup – Menu enter the System security code “xxxxx” and then press the [ENTER] key to confirm the code.

### 10.2 PID Auto/Manual

(Path MENU/PID Setup/PID A-M)



This menu allows selection of Automatic or Manual operation. Use the right arrow and then up or down arrow keys to select Auto or Manual operation. Press [ENTER].

## 10.3 Mode

(Path MENU/PID Setup/Mode)



This menu contains the selection of control modes using relays or analog outputs. Press [ENTER].

### 10.3.1 PID Mode

This menu assigns a relay or analog output for PID control action as well as details of their operation. Based on the control device being used, select one of the following three paragraphs for use with solenoid valve, pulse input metering pump or analog control.

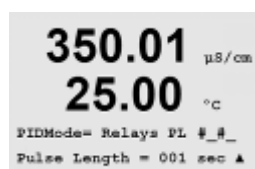

**Pulse Length** - If using a solenoid valve, select "Relays" and "PL", Pulse Length. Choose the first relay position as #1 if controlling a concentrating reagent feed. Choose the second relay position as #2 if controlling dilution water. Set the pulse length (feed cycle time) in seconds. A short pulse length will provide more uniform feed. A longer pulse length will reduce wear on the solenoid valve. A value of 30 seconds may be a good starting point. The % "on" time in the cycle is proportional to the control output.

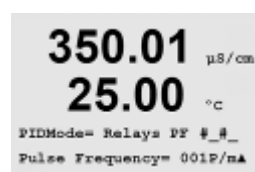

**Pulse Frequency** - If using a pulse input metering pump, select "Relays" and "PF", Pulse Frequency. Choose the first relay position as #3 if controlling a concentrating chemical feed. Choose the second relay position as #4 if controlling dilution water. Set the pulse frequency to the maximum frequency allowed for the particular pump being used, typically 60 to 100 pulses/minute. Control action will produce this frequency at 100% output. CAUTION: Setting the Pulse Frequency too high may cause the pump to overheat.

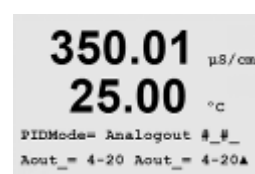

**Analog** - If using Analog control, change "Relays" to "Analogout" using up/down arrow keys. Choose the first Analogout position as #1 if controlling a concentrating chemical feed. Choose the second Analogout position as #2 if controlling dilution water feed. Select the analog output current range required by the control device, 4-20 or 0-20 mA. Press [ENTER].

## 10.4 Tune Parameters

(Path MENU/PID Setup/Tune Parameters)



This menu assigns control to a measurement and sets the setpoint, tuning parameters and non-linear functions of the controller through a series of screens.

### 10.4.1 PID Assignment & Tuning



Assign the measurement, a, b, c, or d to be controlled after "PID on\_". Set the Gain (unitless), Integral or Reset time Tr (minutes) and Rate or Derivative time Td (minutes) needed for control. Press [ENTER]. Gain, Reset and Rate are later adjusted by trial and error based on process response.

### 10.4.2 Setpoint & Deadband



Enter the desired setpoint value and the deadband around the setpoint, where no proportional control action will take place. Be sure to include the units multiplier  $\mu$  or m. Press [ENTER].

### 10.4.3 Proportional Limits



Enter the low and high proportional limits—the range over which control action is required. Be sure to include the units multiplier  $\mu$  or m. Press [ENTER].

### 10.4.4 Corner Points



Enter the low and high corner points in conductivity units and the respective output values from -1 to +1, shown in the figure as -100 to +100%. Press [ENTER].

## 10.5 PID Operation





In the normal measurement mode, with PID Display selected, the status (Man or Auto) and control output (%) will be displayed on the bottom line.

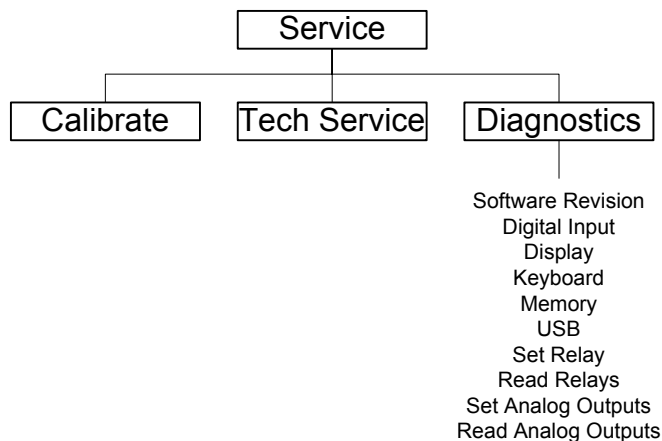

In Manual, the control output may be adjusted with the up and down arrow keys. (The "Info" key function is not available in Manual.)

# 11 Service

(PATH: Menu/Service)



While in Measurement mode press the  key.

Press the  or  key to navigate to 'Service' and press [ENTER]. After selecting 'Service', press the [ENTER] key to find the following system configuration options.

## 11.1 Diagnostics

(PATH: Menu/Service/Diagnostics)



This Menu is a valuable tool for troubleshooting and provides diagnostic functionality for following items: SW Revision, Digital Inputs, Display, Keypad, Memory, Set Relay, Read Relays, Set Analog Outputs, Read Analog Outputs

### 11.1.1 Software Revision

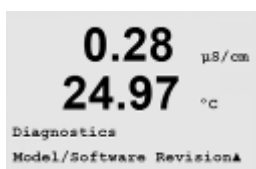

Essential information for every Service call is the Software Revision number. This Menu shows the transmitter part number, serial number and software version number. Press [ENTER] to exit from this display.



### 11.1.2 Digital Input



The digital Input menu shows the state of the digital input. Press [ENTER] to exit from this display.



### 11.1.3 Display



All pixels of the display will be lit for 15 seconds to allow troubleshooting of the display. After 15 seconds the transmitter will return to the normal measuring model or press [ENTER] to exit sooner.

### 11.1.4 Keypad



For the keypad diagnostics the display will indicate which key is pressed. Pressing [ENTER] will return the transmitter to the normal measuring mode.

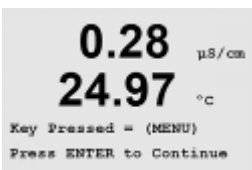



### 11.1.5 Memory



If Memory is selected then the transmitter will perform a RAM and ROM memory test. Test patterns will be written to and read from all RAM memory locations. The ROM checksum will be recalculated and compared to the value stored in the ROM.

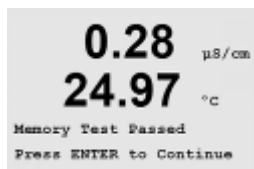

### 11.1.6 Set Relay

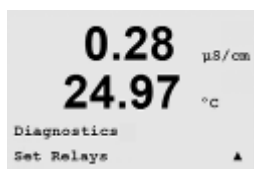

The Set Relays diagnostic menu allows for the manual activation/deactivation of each Relay.



### 11.1.7 Read Relays



The Read Relays diagnostic menu shows the state of each Relay. Press [ENTER] to exit from this display.



### 11.1.8 Set Analog Outputs



This menu enables the user to set all analog outputs to any mA value within the 0-22 mA range.



### 11.1.9 Read Analog Outputs



This menu shows the mA value of the analog Outputs. Press [ENTER] to exit from this display.



## 11.2 Calibrate

(PATH: Menu/Service/Calibrate)



This menu has the options to calibrate the transmitter and the analog outputs and also allows the unlocking of calibration functionality.

### 11.2.1 Calibrate Meter

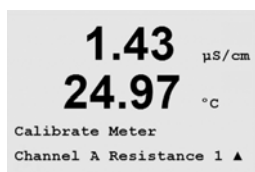

The 300 transmitter is factory calibrated within specifications. It is not normally necessary to perform meter re-calibration unless extreme conditions cause an out of spec operation shown by Calibration Verification. Periodic verification/re-calibration may also be necessary to meet Q.A. requirements. The meter is equipped with five (5) internal ranges of measurement on each channel. Each resistance range and temperature is calibrated separately, with each resistance range consisting of a two-point calibration and the temperature using a three-point calibration.

Below is a table showing the resistance values for all calibration ranges.

Range:	Point 1	Point 2	Point 3
Resistivity 1	1.0 Mohms	10.0 Mohms	-
Resistivity 2	100.0 Kohms	1.0 Mohms	-
Resistivity 3	10.0 Kohms	100.0 Kohms	-
Resistivity 4	1.0 Kohms	10.0 Kohms	-
Resistivity 5	100 Ohms	1.0 Kohms	-
Temperature	1000 Ohms	3.0 Kohms	66 Kohms

It is recommended that both calibration and verification be performed using the M300 Calibrator Module Accessory (refer to accessory list, in section X). Instructions on the use of this accessory are provided with the calibrator module.

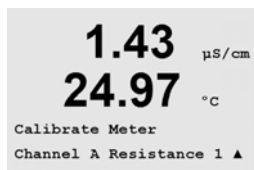

When Calibrate Meter is selected, the display will show Channel A and Resistivity 1, designating that the transmitter is ready to calibrate the first range resistor. This field may be changed, selecting resistance range 1 thru 5, or temperature. Each resistance range consists of a two-point calibration. The temperature calibration consists of a three-point calibration (see table for temperature resistance values)

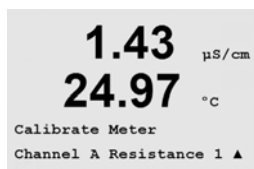

Press Enter to begin the calibration process.



The first text line will ask for the Point 1 resistance value (this will correspond to Resistance 1 value shown on the Calibration Module Accessory). The second text line will show the measured resistance value. When the value stabilizes, press Enter to perform calibration.

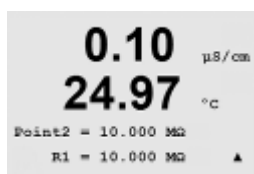

The transmitter screen will then prompt the user to enter the value for Point 2, and R2 will display the measured resistance value. When this value stabilizes, press Enter to calibrate this range.

Once point 1 and 2 are calibrated, return to the Calibrate Meter screen. Move the cursor to change Channel A to Resistance 2, designating the second calibration range. Proceed with the two-point calibration process as performed for the first range. This same process must be followed to complete the resistance calibration of all 5 ranges.

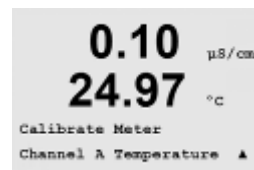

Next, return to the Calibrate Meter screen and choose Temperature calibration for Channel A, as shown.

Press Enter to begin temperature calibration process



The first text line will ask for the Point 1 temperature resistance value (this will correspond to Temperature 1 value shown on the Calibration Module Accessory). The second text line will show the measured resistance value. When value stabilizes, press Enter to perform calibration.

The transmitter screen will then prompt the user to enter the value for Point 2, and R2 will display the measured resistance value. When this value stabilizes, press Enter to calibrate this range.



Repeat these steps for Point 3.

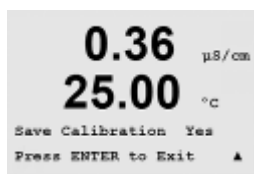

Press Enter and the transmitter will ask to 'Save Calibration'.

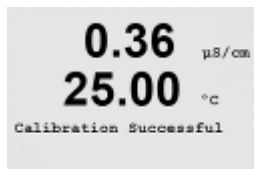

Select Yes to save the calibration values and the successful Calibration is confirmed on the display.

The transmitter will return to the operation mode in approximately 5 seconds.

## 11.2.2 Calibrate Analog



Select the Analog Output you wish to calibrate. Each Analog output can be calibrated at 4 and 20 mA.



Connect an accurate milliammeter to the Analog output terminals and then adjust the five digit number in the display to set the output to 4.00 mA and repeat for 20.00 mA.



As the five digit number is increased the output current increases and as the number is decreased the output current decreases. Thus coarse changes in the output current can be made by changing the thousands or hundreds digits and fine changes can be made by changing the tens or ones digits.

Pressing the [ENTER] key after entering both values will bring up a confirmation screen. Selecting No will discard the entered values, selecting Yes will make the entered values the current ones.

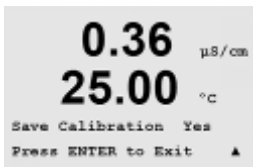

### 11.2.3 Calibrate Unlock

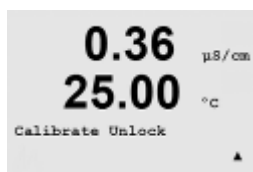

Select this Menu to configure the CAL Menu, see chapter 7.

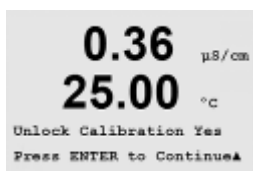

Selecting Yes means that Meter and Analog Output calibration Menus will be selectable under the CAL Menu. Selecting No means that only the Sensor calibration is available under the CAL Menu.

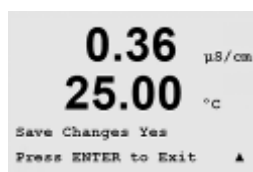

Pressing the [ENTER] key after the selection will bring up a confirmation screen. Selecting No will discard the entered values, selecting Yes will make the entered values the current ones.

## 11.3 Tech Service

(PATH: Menu/Tech Service)



Note: This Menu is for Mettler Toledo Service personnel use only.

## 12 Info

(PATH: Info)

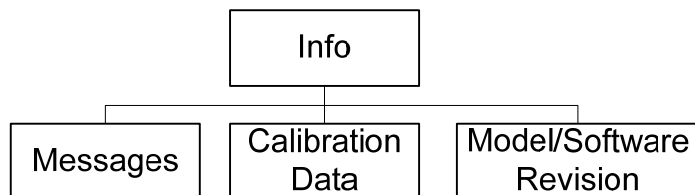

Pressing the  key will display the Info Menu with the options Messages, Calibration Data and Model/Software Revision.

### 12.1 Messages

(PATH: Info/Messages)

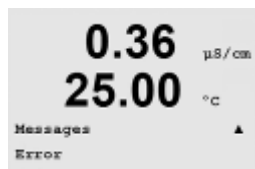

The most recent message is displayed. The up and down arrow keys allow scrolling through the last four messages that have occurred.



Clear Messages clears all the messages. Messages are added to the message list when the condition that generates the message first occurs. If all messages are cleared and a message condition still exists and started before the clear then it will not appear in the list. For this message to re-occur in the list the condition must go away and then reappear.

## 12.2 Calibration Data

(PATH: Info/Calibration Data)



Selecting Calibration Data displays the slope (M) and offset calibration constants (A).

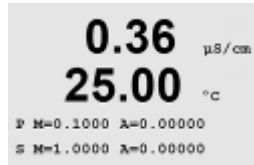

P = calibration constants for the primary measurement  
S = calibration constants for the secondary measurement

## 12.3 Model/Software Revision



Selecting Model/Software Revision will display the installed Firmware revision.

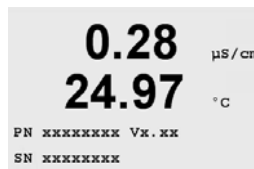

The displayed information is important for any Service call. Press Enter to return to the normal measurement mode.



## 13 Maintenance

### 13.1 For Technical Support

For technical support and product information contact:  
Your local Mettler-Toledo Sales Office or representative

### 13.2 Front Panel Cleaning

Clean the front panel with a damp soft cloth (water only, no solvents). Gently wipe the surface and dry with a soft cloth.

## 14 Troubleshooting

If the equipment is used in a manner not specified by Mettler-Toledo Thornton, Inc., the protection provided by the equipment may be impaired.

Review the table below for possible causes of common problems:

Problem	Possible Cause
Display is blank.	No power to M300. Blown fuse. LCD display contrast set incorrectly. Hardware failure.
Incorrect measurement readings.	Sensor improperly installed. Incorrect units multiplier entered. Temperature compensation incorrectly set or disabled. Sensor or transmitter needs calibration. Sensor or patch cord defective or exceeds recommended maximum length. Hardware failure.
Measurement readings not stable.	Sensors or cables installed too close to equipment that generates high level of electrical noise. Recommended cable length exceeded. Averaging set too low. Sensor or patch cord defective.
Displayed '!' is flashing.	Setpoint is in alarm condition (setpoint exceeded).
Cannot change menu settings.	User locked out for security reasons.

## 14.1 Changing the Fuse



Make sure that the mains cable is unplugged before changing the fuse. This operation should only be carried out by personnel familiar with the transmitter and who are qualified for such work.

If the power consumption of the M300 transmitter is too high or a manipulation leads to a short circuit the fuse will blow. In this case remove the fuse and replace it with one specified in Chapter 16.

## 15 Accessories and Spare Parts

Please contact your local Mettler-Toledo Sales office or representative for details for additional accessories and spare parts.

## 16 Specifications

### 16.1 General specifications

Conductivity / resistivity ranges	
0.01 cm <sup>-1</sup> constant sensor	0.002 to 200 μS/cm (5000Ω x cm to 500 MΩ x cm)
0.1 cm <sup>-1</sup> constant sensor	0.02 to 2000 μS/cm (500Ω x cm to 50 MΩ x cm)
10 cm <sup>-1</sup> constant sensor	10 to 40,000 μS/cm (25Ω x cm to 100 KΩ x cm)
4-electrode sensor	0.01 to 650 mS/cm (1.54Ω x cm to 0.1MΩ x cm)
Chemical concentration curves	HCl, NaOH, H2SO4: 0-20%, 0-15%, 0-20%
TDS range (CaCO3 and NaCl)	Covers equivalent conductivity ranges
Temperature input	PT 1000
Temperature measuring range	- 40 to + 200.0 °C (-40 to 392 °F)
Sensor maximum distance	61 m (200 ft); 15 m (50 ft with 4-E sensors)
Cond/Res accuracy	± 0.5% of reading or 0.5Ω, whichever is greater, Up to 18 MΩ-cm
Repeatability	± 0.1% of reading for resistance
Resolution	0.001 (four significant digits)
Temperature resolution	0.1 °C ( 0.1 °F)
Temperature relative accuracy	± 0.25°C (± 0.45 °F)
Temperature repeatability	± 0.13°C (± 0.23 °F)

### 16.2 Electrical specifications for 1/2DIN and 1/4DIN versions

Power requirements	100 to 240 V AC or 20 to 30 V DC, 5 W
Frequency	50 to 60 Hz
Analog output signals	Two 0/4 to 22 mA outputs for pH/mV and temperature, galvanically isolated from input and from earth ground
Measurement Error through analog outputs	< 0.5% of full scale
Analog output configuration	Linear, Bi-Linear, Logarithmic, Autoranging
Load	max. 500 Ω
Connection terminals	Detachable screw terminals
Digital communication	USB port, Type B connector
PID process controller	Pulse length, pulse frequency or analog control
Connection terminals	Detachable screw terminals
Digital Input	1
Mains power fuse	1.0 A slow blow type FC
Relays	2-SPDT mechanical 250VAC, 30 VDC, 3 Amps resistive 2-Reed 250VAC or DC, 0.5 A, 10 W
Alarm Relay delay	0 – 999 s
Keypad	5 tactile feedback keys
Display	four-line

### 16.3 Mechanical specifications for 1/4DIN version

Dimensions (housing - H x W x D)*	90 x 90 x 140 mm (1/4DIN model)
Front bezel – (H x W)	102 x 102 mm
Max. depth	125 mm (excludes plug-in connectors)
Weight	0.6 kg (1.5 lb)
Material	ABS/polycarbonate
Insulation/rating	NEMA 4X, IP 65 (front) / IP 20 (housing)

\* H=Height, W=Width, D=Depth

### 16.4 Mechanical specifications for 1/2DIN version

Dimensions (housing - L x H x W)*	144 x 144 x 116 mm
Front bezel - H x W	150 x 150 mm
Max. D - panel mounted	87 mm (excludes plug-in connectors)
Weight	0.95 kg (2 lb)
Material	ABS/polycarbonate
Insulation / rating	NEMA 4X, IP 65

\* H=Height, W=Width, D=Depth

### 16.5 Environmental specifications for 1/2DIN and 1/4DIN versions

Storage temperature	-40 to 70 °C (-40 to 158 °F)
Ambient temperature operating range	-10 to 50 °C (14 to 122 °F)
Relative humidity	0 to 95% non-condensing
Emissions	According to EN55011 Class A
UL Electrical Environment	Installation (overvoltage) category II

## 17 Default tables

Alarm	Relay	2	
	diagnostics	off	
	power failure	off	
	software failure	off	
	delay	1	sec
	hysteresis	0	
	state	inverted	
Clean	relay	1	
	hold mode	NA	
	interval	0	Hrs
	clean time	0	Sec
	state	normal	
	delay	0	
	hysteresis	0	
Language		English	
Passwords	administrator	00000	
	operator	00000	
<b>All Relays</b> (unless otherwise specified)	delay	10	sec
	hysteresis	5	%
	state	normal	
	hold mode	NA	
Lockout	(on/off)	no = off	
Channel A	measurement a	Resistivity	$\Omega$ -cm
	measurement b	temperature	$^{\circ}$ C
	measurement c	-	
	measurement d	-	
Cal constants	Cond/Res	M=0.1, A=0.0	
	temperature	M=1.0, A=0.0	
Analog Out	1	a - Cond/Resistivity	M $\Omega$ -cm
	2	b - temperature	$^{\circ}$ C
All analog out	mode	4 - 20 mA	
	type	normal	
	alarm	off	
	hold mode	last value	
Conductivity/Resistivity	value 4 mA	10	M $\Omega$ -cm
	value 20 mA	20	M $\Omega$ -cm
Temperature	value 4 mA	0	$^{\circ}$ C
	value 20 mA	100	$^{\circ}$ C
Set point 1	measurement	a	
	type	off	
	value	0	
Relay 3	set point	1	
Set point 2	measurement	b	
	type	Off	
	value	0	
Relay 4	set point	2	
Resolution	Temperature	0.1	$^{\circ}$ C
	Cond/Res	0.01	$\Omega$ -cm

## 18 Warranty

METTLER TOLEDO warrants this product to be free from significant deviations in material and workmanship for a period of one year from the date of purchase. If repair is necessary and not the result of abuse or misuse within the warranty period, please return by freight pre-paid and amendment will be made without any charge. METTLER TOLEDO's Customer Service Dept. will determine if the product problem is due to deviations or customer abuse. Out-of-warranty products will be repaired on an exchange basis at cost.

The above warranty is the only warranty made by METTLER TOLEDO and is lieu of all other warranties, expressed or implied, including, without limitation, implied warranties of merchantability and fitness for a particular purpose. METTLER TOLEDO shall not be liable for any loss, claim, expense or damage caused by, contributed to or arising out of the acts or omissions of the Buyer or Third Parties, whether negligent or otherwise. In no event shall METTLER TOLEDO's liability for any cause of action whatsoever exceed the cost of the item giving rise to the claim, whether based in contract, warranty, indemnity, or tort (including negligence).

## 19 UL Statement (Pending)

Mettler-Toledo Thornton, Inc., 36 Middlesex Turnpike, Bedford, MA 01730, USA has obtained Underwriters Laboratories' listing for M300 Model Transmitters. They bear the cULus Listed mark, signifying that the products have been evaluated to the applicable ANSI/UL and CSA Standards for use in the U.S. and Canada.



## METTLER TOLEDO Market Organizations

### Sales and Service:

#### Australia

Mettler-Toledo Ltd.  
220 Turner Street  
Port Melbourne  
AUS - 3207 Melbourne / VIC  
Phone +61 31300 659 761  
Fax +61 3 9645 3935  
e-mail mtausprocess@mt.com

#### Austria

Mettler-Toledo Ges.m.b.H.  
Südrandstraße 17  
A - 1230 Wien  
Phone +43 1 604 19 80  
Fax +43 1 604 28 80  
e-mail infoprocess.mtat@mt.com

#### Brazil

Mettler-Toledo Ind. e Com. Ltda.  
Alameda Araguaia  
451 - Alphaville  
BR - 06455-000 Barueri / SP  
Phone +55 11 4166 74 00  
Fax +55 11 4166 74 01  
e-mail sales@mettler.com.br  
service@mettler.com.br

#### China

Mettler-Toledo Instruments  
(Shanghai) Co. Ltd.  
589 Gui Ping Road  
Cao He Jing  
CN - 200233 Shanghai  
Phone +86 21 64 85 04 35  
Fax +86 21 64 85 33 51  
e-mail mtcs@public.sta.net.cn

#### Croatia

Mettler-Toledo d.o.o.  
Mandlova 3  
HR - 10000 Zagreb  
Phone +385 1 292 06 33  
Fax +385 1 295 81 40  
e-mail mt.zagreb@mt.com

#### Czech Republic

Mettler-Toledo spol.s.r.o.  
Trebohosticka 2283 / 2  
CZ - 100 00 Praha 10  
Phone +420 2 72 123 150  
Fax +420 2 72 123 170  
e-mail sales.mtcz@mt.com

#### Denmark

Mettler-Toledo A/S  
Naverland 8  
DK - 2600 Glostrup  
Phone +45 43 27 08 00  
Fax +45 43 27 08 28  
e-mail info.mtdk@mt.com

#### France

Mettler-Toledo  
Analyse Industrielle Sarl  
30, Boulevard de Douaumont  
BP 949  
F - 75829 Paris Cedex 17  
Phone +33 1 47 37 06 00  
Fax +33 1 47 37 46 26  
e-mail mtpro-f@mt.com

#### Germany

Mettler-Toledo GmbH  
ProzeBanalytik  
Ockerweg 3  
D - 35396 Gießen  
Phone +49 641 507 333  
Fax +49 641 507 397  
e-mail prozess@mt.com

#### Great Britain

Mettler-Toledo LTD  
64 Boston Road, Beaumont Leys  
GB - Leicester LE4 1AW  
Phone +44 116 235 7070  
Fax +44 116 236 5500  
e-mail enquire.mtuk@mt.com

#### Hungary

Mettler-Toledo Kereskedelmi KFT  
Teve u. 41  
HU - 1139 Budapest  
Phone +36 1 288 40 40  
Fax +36 1 288 40 50  
e-mail mthu@axelero.hu

#### India

Mettler-Toledo India Private Limited  
Amar Hill, Saki Vihar Road  
Powai  
IN - 400 072 Mumbai  
Phone +91 22 2857 0808  
Fax +91 22 2857 5071  
e-mail sales.mtin@mt.com

#### Italy

Mettler-Toledo S.p.A.  
Via Vialba 42  
I - 20026 Novate Milanese  
Phone +39 02 333 321  
Fax +39 02 356 2973  
e-mail customercare.italia@mt.com

#### Japan

Mettler-Toledo K.K.  
Process Division  
5F Tokyo Ryutsu Center, Annex B  
6-1-1 Heiwajima, Ohta-ku  
JP - 143-0006 Tokyo  
Phone +81 3 5762 07 06  
Fax +81 3 5762 09 71  
e-mail helpdesk.ing.jp@mt.com

#### Malaysia

Mettler-Toledo (M) Sdn Bhd  
Bangunan Electrocon Holding  
Lot 8 Jalan Astaka U8 / 84  
Seksyen U8, Bukit Jelutong  
MY - 40150 Shah Alam Selangor  
Phone +60 3 78 45 57 73  
Fax +60 3 78 45 87 73  
e-mail  
MT-MY.CustomerSupport@mt.com

#### Mexico

Mettler-Toledo S.A. de C.V.  
Pino No. 350, Col. Sta.  
MA. Insurgentes, Col Atlampa  
MX - 06430 México D.F.  
Phone +52 55 55 47 57 00  
Fax +52 55 55 41 22 28  
e-mail mt.mexico@mt.com

#### Poland

Mettler-Toledo (Poland) Sp.z.o.o.  
ul. Poleczki 21  
PL - 02-822 Warszawa  
Phone +48 22 545 06 80  
Fax +48 22 545 06 88  
e-mail polska@mt.com

#### Russia

Mettler-Toledo Vostok ZAO  
Sretenskij Bulvar 6/1  
Office 6  
RU - 101000 Moscow  
Phone +7 495 621 92 11  
Fax +7 495 621 63 53  
+7 495 621 78 68  
e-mail inforus@mt.com

#### Singapore

Mettler-Toledo (S) Pte. Ltd.  
Block 28  
Ayer Rajah Crescent # 05-01  
SG - 139959 Singapore  
Phone +65 6890 00 11  
Fax +65 6890 00 12  
+65 6890 00 13  
e-mail precision@mt.com

#### Slovakia

Mettler-Toledo s.r.o.  
Bulharska 61  
SK - 82104 Bratislava  
Phone +421 244 44 12 20  
Fax +421 244 44 12 23  
e-mail predaj@mt.com

#### Slovenia

Mettler-Toledo d.o.o.  
Peske 12  
SI - 1236 Trzin  
Phone +386 1 530 80 50  
Fax +386 1 562 17 89  
e-mail keith.racman@mt.com

#### South Korea

Mettler-Toledo (Korea) Ltd.  
Yeil Building 1 & 2 F  
124-5, YangJe-Dong  
SeCho-Ku  
KR - 137-130 Seoul  
Phone +82 2 3498 3500  
Fax +82 2 3498 3555  
e-mail Sales\_MTKR@mt.com

#### Spain

Mettler-Toledo S.A.E.  
C / Miguel Hernández, 69-71  
ES - 08908 L'Hospitalet de Llobregat  
(Barcelona)  
Phone +34 93 223 76 00  
Fax +34 93 223 76 01  
e-mail bcn.centralita@mt.com

#### Sweden

Mettler-Toledo AB  
Virkesvägen 10  
Box 92161  
SE - 12008 Stockholm  
Phone +46 8 702 50 00  
Fax +46 8 642 45 62  
e-mail sales.mts@mt.com

#### Switzerland

Mettler-Toledo (Schweiz) GmbH  
Im Langacher  
Postfach  
CH - 8606 Greifensee  
Phone +41 44 944 45 45  
Fax +41 44 944 45 10  
e-mail salesola.ch@mt.com

#### Thailand

Mettler-Toledo (Thailand) Ltd.  
272 Soi Soonvijai 4  
Rama 9 Rd., Bangkok  
Huay Kwang  
TH - 10320 Bangkok  
Phone +66 2 723 03 00  
Fax +66 2 719 64 79  
e-mail MT-TH.Process@mt.com

#### USA / Canada

Mettler-Toledo Ingold, Inc.  
36 Middlesex Turnpike  
Bedford, MA 01730, USA  
Phone +1 781 301 8800  
Toll free +1 800 352 8763  
Fax +1 781 271 0681  
e-mail mtprouds@mt.com  
ingold@mt.com



Management System  
certified according to  
ISO 9001 / ISO 14001

Subject to technical changes.  
© Mettler-Toledo AG, Process Analytics  
02 / 07 - Printed in Switzerland. 52 121 306

Mettler-Toledo AG, Process Analytics  
Industrie Nord, CH - 8902 Urdorf, Switzerland  
Tel. + 41 44 729 62 11, Fax +41 44 729 66 36

[www.mt.com/pro](http://www.mt.com/pro)