

Installation information

METTLER TOLEDO MultiRange
Floor scales / Pit scales

METTLER TOLEDO

MC300/MCS300

MC600/MCS600

MD600/MD1500

ME1500/ME3000

ME1500s/ME3000s

MES1500/MES3000

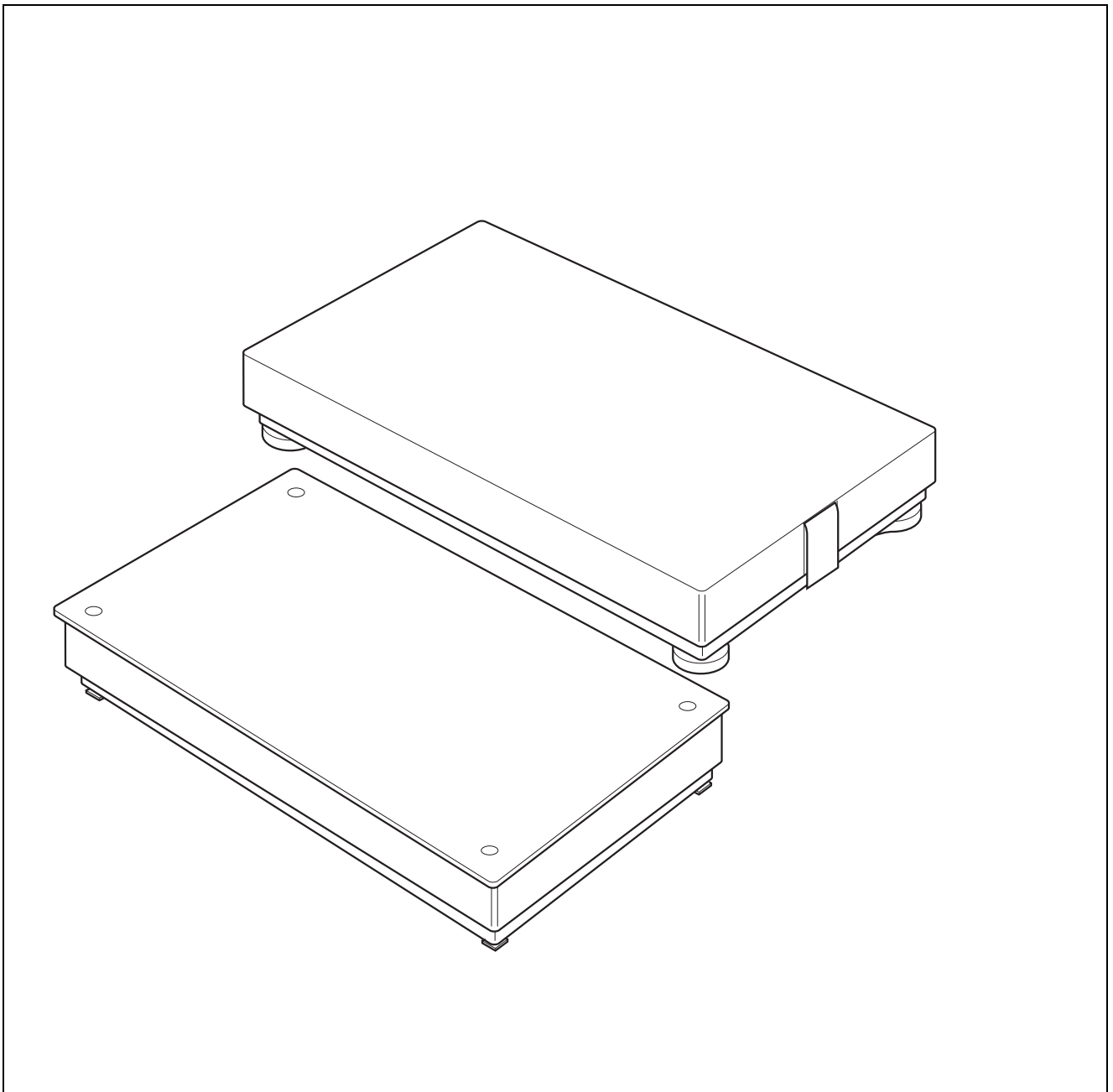

Contents		Page
1	Installation.....	2
1.1	Preparatory work	2
1.2	Setting up and levelling	3
1.3	Installing connection cable	4
1.4	Pit installation	6
2	Configuration possibilities	8
2.1	General information	8
2.2	Configuration data	9
3	Planning assemblies	10
3.1	Notes on planning	10
3.2	Preload range	11
3.3	Mounting possibilities	12
3.4	Opening possibilities	18
4	Dimensions	23

1 Installation

1.1 Preparatory work

1.1.1 Selecting installation location



▲ The explosion-protected weighing platform is approved for operation in Zone 2 (gases) and Zone 22 (dusts) hazardous areas. There is an increased danger of injuries and damage when using the weighing platform in hazardous areas! Special care must be taken when working in such hazardous areas. The rules for behaviour are based on the concept of "Safe Distribution" established by METTLER TOLEDO.

▲ Any protective foils present in the explosion-protected area, e.g. on the load plate, must always be removed.

▲ The foundation at the installation location must be capable of safely support the weight of the weighing platform at its support points when it carries the maximum load. At the same time, it should be so stable that no vibrations occur during weighing operations. These requirements also apply when the weighing platform is integrated in conveying systems and the like.

▲ Ensure that vibrations due to machines near the installation site are kept to a minimum.

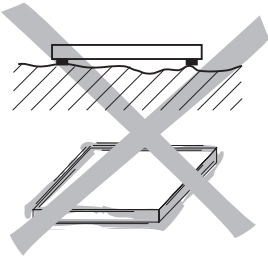

1.1.2 Ambient conditions

- Use powder-coated/enamelled weighing platforms only in a dry environment.
- In a damp environment, in wet operation or when working with chemicals: Use stainless-steel weighing platforms.

1.1.3 Accessories

→ Completely unpack the accessories provided with the weighing platform.

- 1 Identcard
 - 1 Set of signs for selectable configurations
- additionally provided for MD, ME, MES:
- 4 Eye bolts in bag
- additionally provided for ME1500s/ME3000s:
- 2 Eye bolts in bag
 - 1 Special key
 - 1 Universal oil

1.2 Setting up and levelling

1.2.1 Setting up and levelling MC/MCS

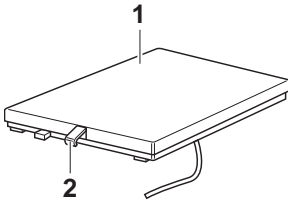

1. To reduce weight, first lift off the load carrier (1). Fold out the lift-off locks (2) on both faces of the load carrier to use as handles.
2. Lift the weighing platform off the transport pallet and set down at the installation location.
Be careful when lifting it off the pallet to prevent the lever mechanism open at the bottom from being damaged.

Releasing transport lock

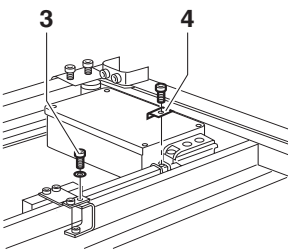

1. Unscrew and remove the yellow locking screw (3).
2. Unscrew the yellow angled locking bracket (4).

Keep the locking elements for use when transporting the weighing platform in the future.

Levelling

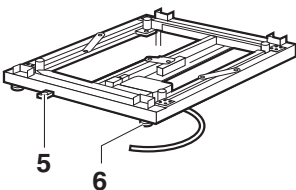

1. Level the weighing platform with the four foot bolts (6) using the level indicator (5): The air bubble of the level indicator must come to rest in the centre of the ring marking.
2. Ensure even contact of the foot bolts. Check the stability of the weighing platform by pressing down on or rocking it at the corners.

1.2.2 Setting up and levelling MD/ME/MES/ME...s

Setting up MD/MES

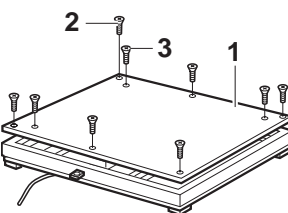

1. Lift off the load plate (1) after unscrewing the 6 or 8 screws (2). The eye bolts can be screwed into the threads (3) after removing the blind screws as lifting aid. Depending on the shipping warehouse or the model ordered, the load plate may also be included in separate packing. Then the mounting screws and the blind screws are supplied in the accessories bag.

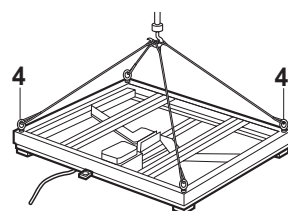

2. Lift the weighing platform off the transport pallet. To do this, screw the four eye bolts (4) provided into the threads at the corners of the load plate mounting device and lift off the weighing platform with a crane, block and tackle or similar equipment and set it down at the installation location.

ATTENTION

Danger of damage to the lever mechanism open at the bottom when using forklift trucks.

- Move up the load forks of the forklift truck and hang the weighing platform on them as described.

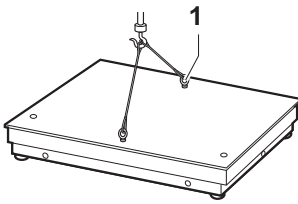

Setting up ME...s

1. Lift the weighing platform off the transport pallet. To do this, screw the two eye bolts (1) provided (they are located on the inside on the level indicator side) into the threads of the load plate mounting device and lift off the weighing platform with a crane, block and tackle or similar equipment and set it down at the installation location.
2. Remove the eye bolts.
3. Open the two quick release locks with the special key and fold up the load plate (special key is used as an aid when lifting off).

ATTENTION

Danger of damage to the lever mechanism open at the bottom when using forklift trucks.

- Move up the load forks of the forklift truck and hang the weighing platform on them as described.

Releasing the lift-off locks

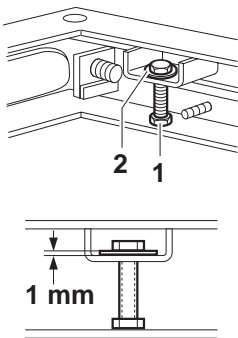

1. Loosen the nuts (1) at all four corners. Screw up the locking screws (2) and adjust evenly to approx. 1 mm clearance at all four corners.
2. Retighten the nuts (1).

Levelling MD/ME/MES/ME...s

- Level the weighing platform with the 4 levelling feet (2) using the level indicator (1): The air bubble of the levelling indicator must be located within the ring marking.

The levelling feet can be adjusted with a 30 mm open-end spanner. Ensure even contact of the levelling feet.

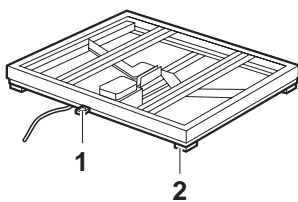

1.3 Installing connection cable

Note

The connection cable may be lengthened to a maximum of 100 m.

- Route the connection cable to the terminal so that it is protected from possible damage.

1.3.1 MC/MCS

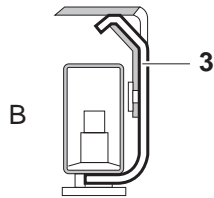
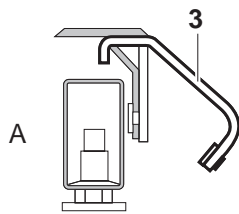
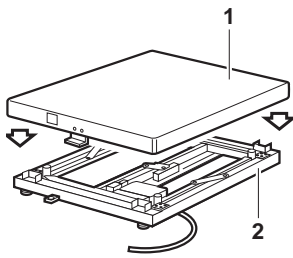

The connection cable is stored inside the weighing platform during transport for protection.

1. Route out the connection cable under the base frame.
2. Remount the load carrier (1) so that the symbol **O** is located above the level indicator. Make sure that the load supports (2) in the corners of the weighing platform are vertical.
3. Fold out the lift-off locks (3) on both faces of the load carrier for lifting. The lift-off locks are used both to lift off the load carrier (Pos. A) and to prevent lifting off and tilting (Pos. B) during weighing.

1.3.2 MD/ME/ME...s

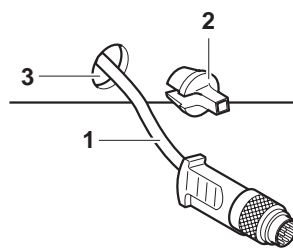

The connection cable (1) is stored inside the weighing platform during transport for protection. Depending on the conditions at the installation location, the connection cable can be routed out as follows:

- Below the weighing platform on the floor:
Ideal with the recessing installation of the weighing platform. In the case of above-floor installation protective cable bridges can be laid up to under the weighing platform.
- Through the base frame:
Remove the rubber grommet (2) from the hole (3) in the base frame and pull through the connection cable (1). Push the slotted rubber grommet (2) over the cable and insert it in the hole (3).

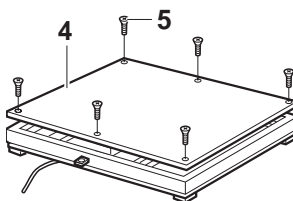

1. Lay on the load plate (4) (fold down) and mount it with the screws (5) (quick-release locks).
2. Screw the blind screws into the threads.

1.4 Pit installation

1.4.1 Producing pit

The mounting material and detailed instructions for constructing the pit are included with the pit-frame installation kit. The proper construction of the pit according to these instructions is a requirement.

1.4.2 Installing the MC/MCS weighing platform

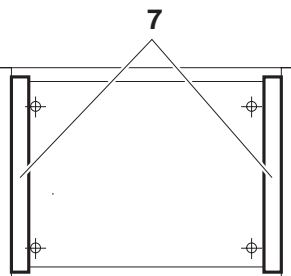
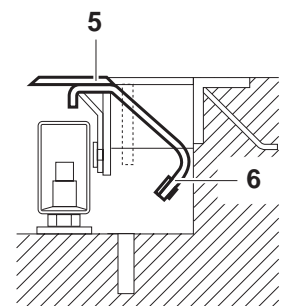
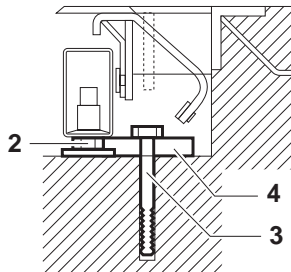
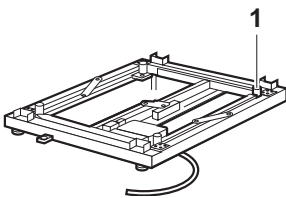
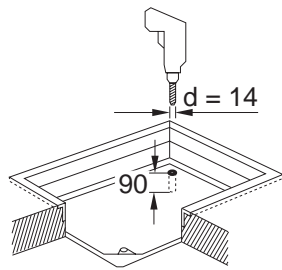

1. Lay the drawing provided in the pit as a drilling template. Centre the template in all directions and secure with adhesive tape. Drill the four holes at the points marked and insert the plugs.
2. Measure the pit depth at the corners.
3. Roughly adjust the weighing platform to the height of or flushness with the floor outside the pit using the foot bolts.
4. Lift off the load carrier, see Section 1.2.1.
5. Place the weighing platform in the pit and align. When doing so, also pull the cable into the empty pipe or cable conduit. For details on routing the empty pipe to the terminal, see the instructions on pit construction.
6. Adjust flushness to the floor. To do this, lay a 6 mm spacer on the load supports (1) and check with a ruler from the upper edge of the pit frame. Adjust the height with the foot bolts while ensuring even contact of the support feet, see Section 1.2.1.
7. Mount the weighing platform on the pit floor on the four foot bolts (2) with the screws (3) and lugs (4). Before tightening, check the distance to the pit edge.
8. Release the transport locks, see Section 1.2.1.
9. Fit the load carrier (5). The swivelled-out lifting and tilting locks (6) on both faces of the weighing platform serve as lifting aids.
10. Lay the left and right cover strips (7) in the pit frame.
11. Final inspection: Make sure that the distance between the load carrier and the pit frame is equal on all sides.

1.4.3 Installing weighing platform MD/ME/ME...s

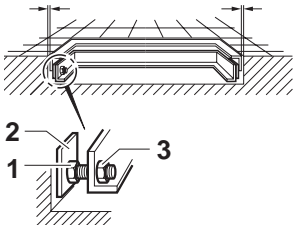
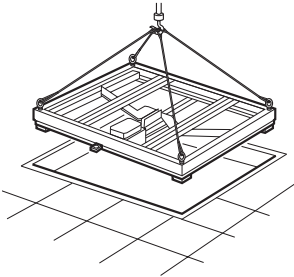

1. Lift off the load plate and route out the connection cable under the weighing platform, see Section 1.2.2.
2. Slowly lower the weighing platform into the pit by the eye bolts. When doing so, also pull the cable into the empty pipe or cable conduit.
3. Release the lift-off lock, see Section 1.2.2.
4. Adjust flushness to the floor. To do this, lay spacers (MD/ME: 8 mm, ME...s: 6 mm) on the load frame at the corners and adjust flush with the upper edge of the pit frame. Adjust the height of the support feet. To level, see section 1.2.2.
5. Insert the clamping plates (2) provided in the installation kit between the pit wall and the clamping screw (1) so that they stand up on the pit floor. Centre the weighing platform in the pit with 6 or 8 clamping screws (1) and clamp firmly in place. Lock the bolts (1) on the inside of the base frame with the nuts (3).
6. Lay on the load plate and screw on firmly.

2 Configuration possibilities

2.1 General information

2.1.1 MultiInterval

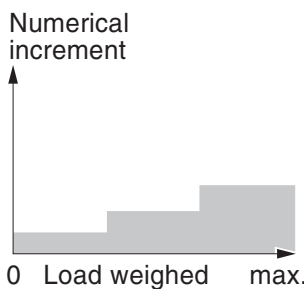

- MultiInterval precision means automatic switchover of the numerical increment (readability) in dependence on the applied load.
- All other adjustment variables (adjustment to the weighing process and vibrations, as well as adjustment of stability monitoring and the zero point correction) are adjusted to the usual user conditions, however can be changed in the master mode of the weighing terminal if necessary.

Notes

- The Identcard provided is labelled with the standard configuration. Mount the Identcard in accordance with the installation instructions of the weighing terminal concerned.
- If the standard configuration does not meet your needs, it is possible to reconfigure the weighing platform with the terminal. To do this, see the terminal operating instructions of the Service Manual for the Point A/D Converter.
- A set of measuring data signs is provided with the weighing platform. Apply the selected configuration corresponding to the factory-mounted measuring data sign to the Identcard, and the Max-Min sign near the terminal display.
- When the configuration is changed, it is also possible to change the preload range in addition to the weighing range and the readability.

2.2 Configuration data

2.2.1 Configuration data for MC/MCS, factory setting

Standard configuration	MC300	MCS300	MC600/MCS600
Maximum load	300 kg	300 kg	600 kg
Readability	0 ... 60 kg 0.02 kg 60 ... 150 kg 0.05 kg 150 ... 300 kg 0.1 kg	0 ... 60 kg 0.02 kg 60 ... 150 kg 0.05 kg 150 ... 300 kg 0.1 kg	0 ... 150 kg 0.05 kg 150 ... 300 kg 0.1 kg 300 ... 600 kg 0.2 kg
Tare range, subtractive	300 kg	300 kg	600 kg
Preload range Zero-set range Zero-set range (typ.)	± 6 kg 44 kg	± 6 kg 54 kg	± 12 kg 108 kg
Calibration data as per OIML Calibration class Calibration value Minimum load Temperature range	III 0.02 kg 0.4 kg -10 °C ... +40 °C	III 0.02 kg 0.4 kg -10 °C ... +40 °C	III 0.05 kg 1.0 kg -10 °C ... +40 °C

2.2.2 Configuration data for MD/ME, factory setting

Standard configuration	MD600	MD1500/ME1500/ MES1500/ME1500s	ME3000/MES3000/ ME3000s
Maximum load	600 kg	1500 kg	3000 kg
Readability	0 ... 150 kg 0.05 kg 150 ... 300 kg 0.1 kg 300 ... 600 kg 0.2 kg	0 ... 300 kg 0.1 kg 300 ... 600 kg 0.2 kg 600 ... 1500 kg 0.5 kg	0 ... 600 kg 0.2 kg 600 ... 1500 kg 0.5 kg 1500 ... 3000 kg 1.0 kg
Tare range, subtractive	600 kg	1500 kg	3000 kg
Preload range Zero-set range Zero-set range (typ.)	± 12 kg 70 kg	± 30 kg 270 kg	± 60 kg 540 kg
Calibration data as per OIML Calibration class Calibration value Minimum load Temperature range	III 0.05 kg 1.0 kg -10 °C ... +40 °C	III 0.1 kg 2.0 kg -10 °C ... +40 °C	III 0.2 kg 4.0 kg -10 °C ... +40 °C

3 Planning assemblies

3.1 Notes on planning

Due to their design characteristics, the weighing platforms are suitable for installation in conveying systems. The following specifications and dimensional drawings form the basis for the design of the required assemblies.

- The weighing platform may only be supported by the support feet, and never by the frame or lever parts.
- The weighing platform may only be permanently installed on the support feet.
- Moving or rotating parts on the weighing platform must be designed so that they do not affect the weighing result. Balance rotating parts.
- The load plate must be free on all sides so that not connection between the load plate and permanently mounted parts is made, even by falling parts or dirt deposits.
- Lay cables or hoses between the weighing platform and other machine parts so that they do not exert any force on the weighing platform.

CAUTION

When mounting assemblies, make sure that no metal chips get into the weighing platform.

- Remove the load plate to machine the weighing platform.

3.2 Preload range

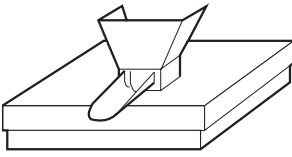

The weight of the structural parts permanently mounted on the weighing platform is referred to as "preload". The preload is electrically compensated in the weighing platform so that the full weighing range is available.

The maximum preload (or the zero-set range) that can be compensated is dependent on the configured weighing range.

CAUTION

The assemblies must already be mounted when connecting the weighing platform.

Model	Weighing range	Max. preload
MC300	300 kg	44 kg
MCS300	300 kg	54 kg
MC600	600 kg	108 kg
MCS600	600 kg	108 kg
MD600	600 kg	70 kg
MD1500	1500 kg	270 kg
ME1500/MES1500	1500 kg	270 kg
ME1500s	1500 kg	270 kg
ME3000/MES3000	3000 kg	540 kg
ME3000s	3000 kg	540 kg

3.3 Mounting possibilities

3.3.1 Mounting possibilities for MC300/MC600

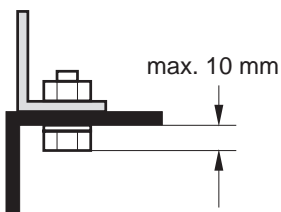
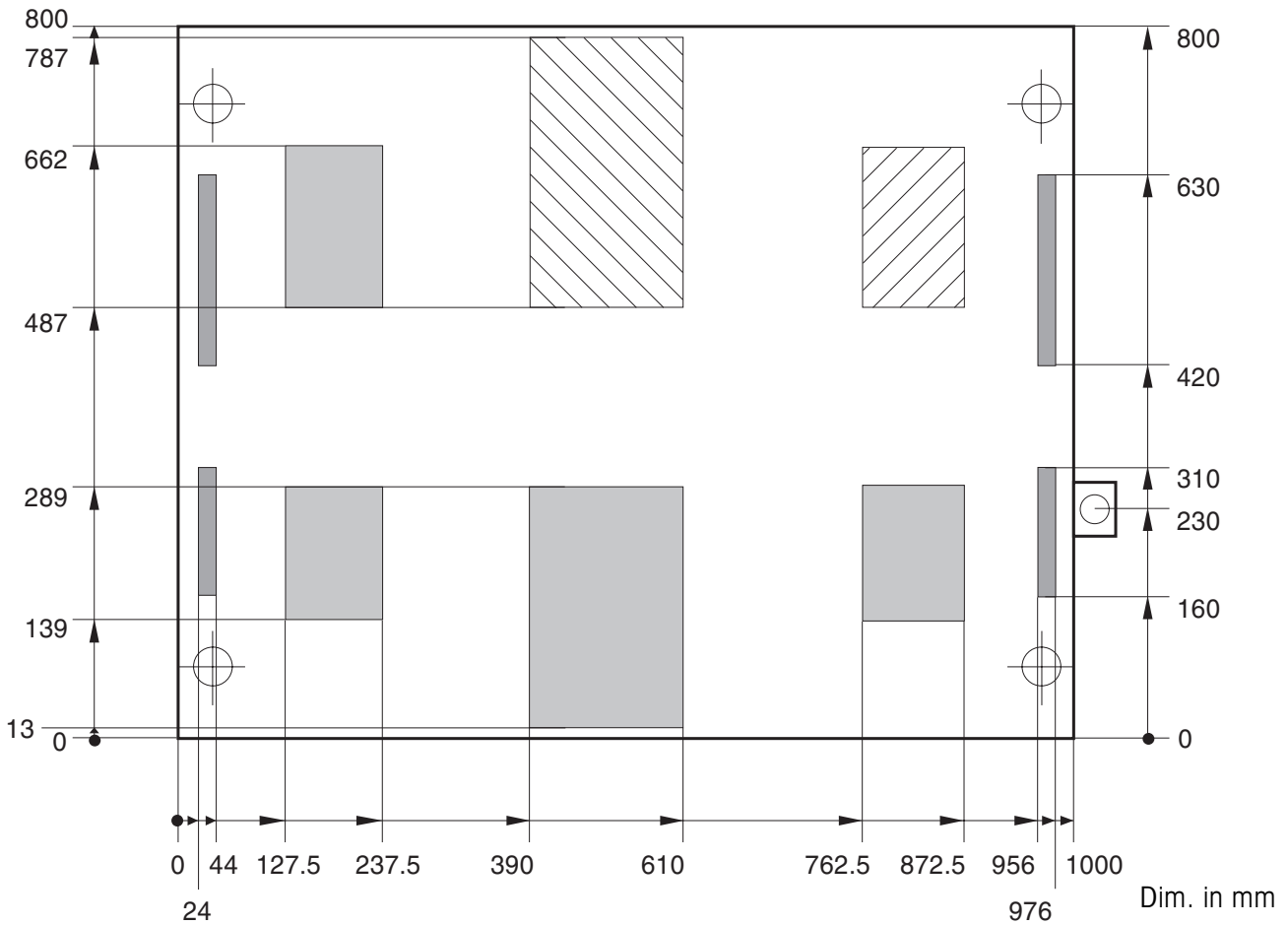

- Bridge assemblies can be mounted in the shaded or hatched areas.
- Recommended mounting type: Bolting on.
Remove the load plate and drill through for this purpose.
- Mounting parts (e.g. bolts and nuts) may extend a maximum of 10 mm beyond the underside of the load plate.



Only for MC300



Only for MC600



For MC300 and MC600

Technical version: 08/00

3.3.2 Mounting possibilities for MCS300/MCS600

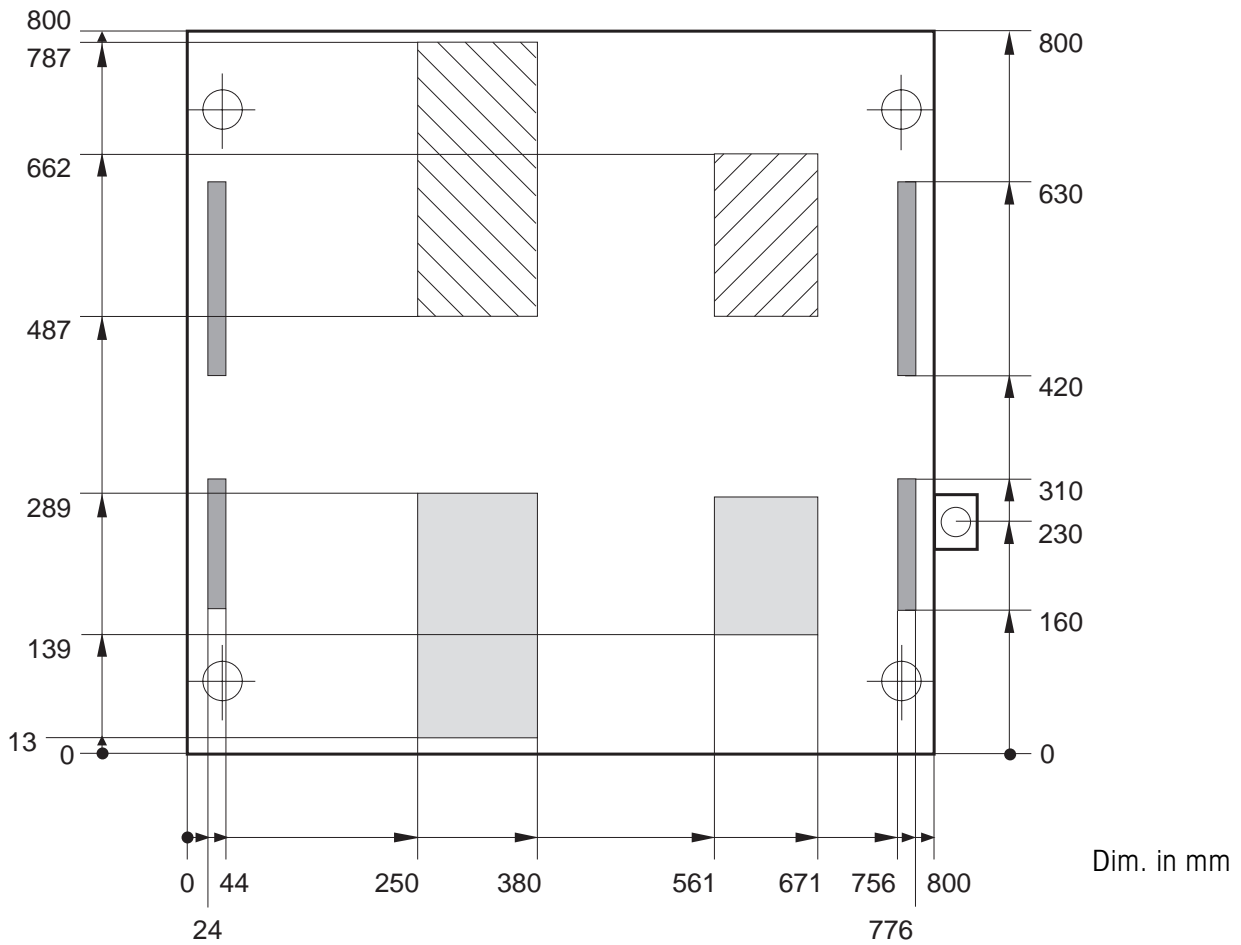

Dim. in mm

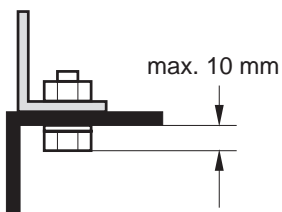

- Bridge assemblies can be mounted in the shaded areas.
- Recommended mounting type: Bolting on.
Remove the load plate and drill through for this purpose.
- Mounting parts (e.g. bolts and nuts) may extend a maximum of 10 mm beyond the underside of the load plate.



Only for MCS300



Only for MCS600



For MCS300 and MCS600

Technical version: 08/00

3.3.3 Mounting possibilities for MD600/MD1500

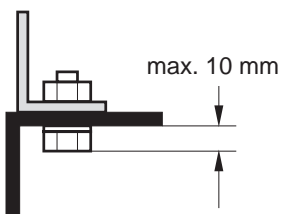
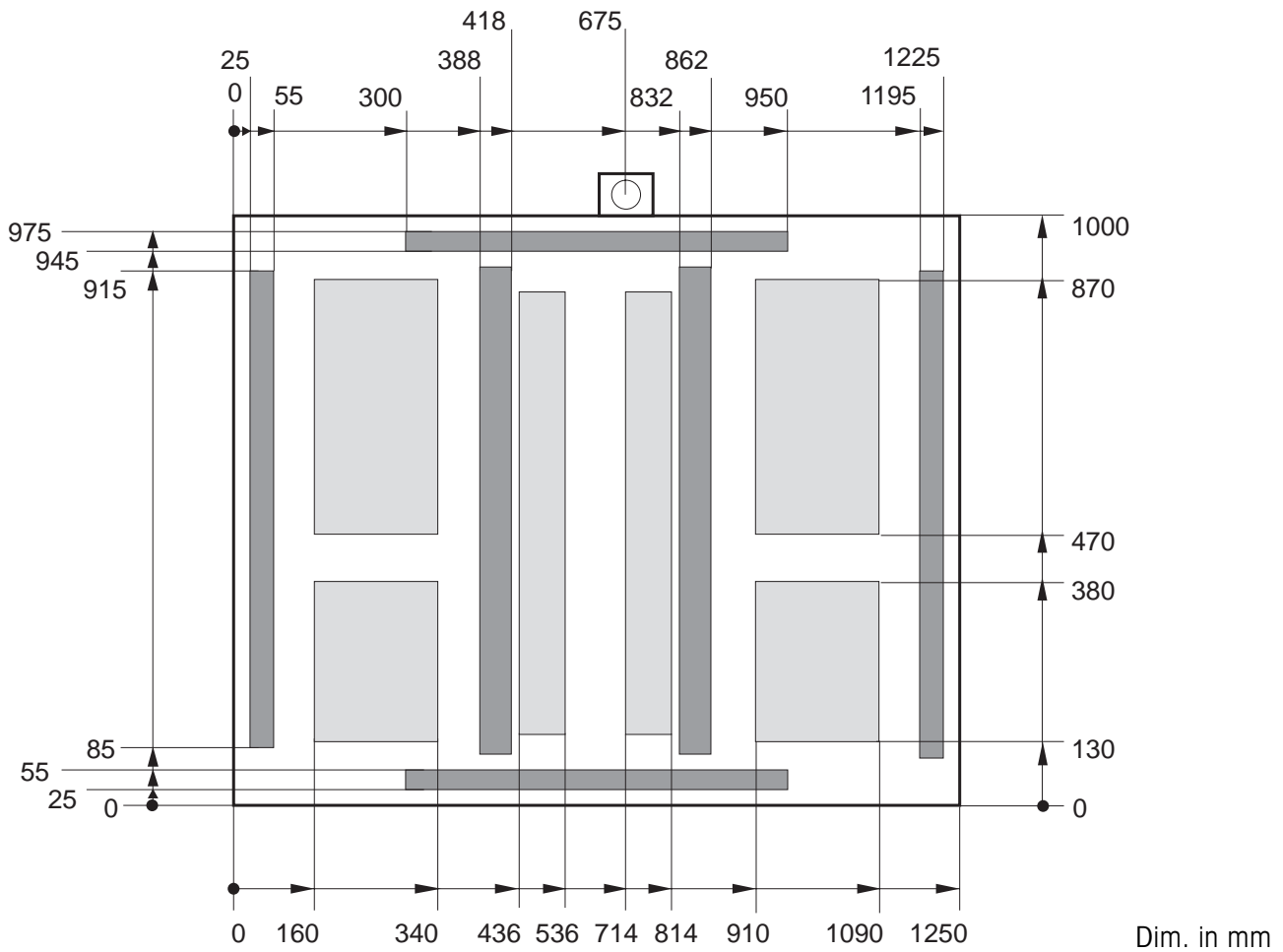

- Bridge assemblies can be mounted in the shaded areas.
- Recommended mounting type: Bolting on.
Remove the load plate and drill through for this purpose.
- Mounting parts (e.g. bolts and nuts) may extend a maximum of 10 mm beyond the underside of the load plate or load frame.



Mounting possibilities on the load plate





Mounting possibilities on the load frame

Technical version: 08/00

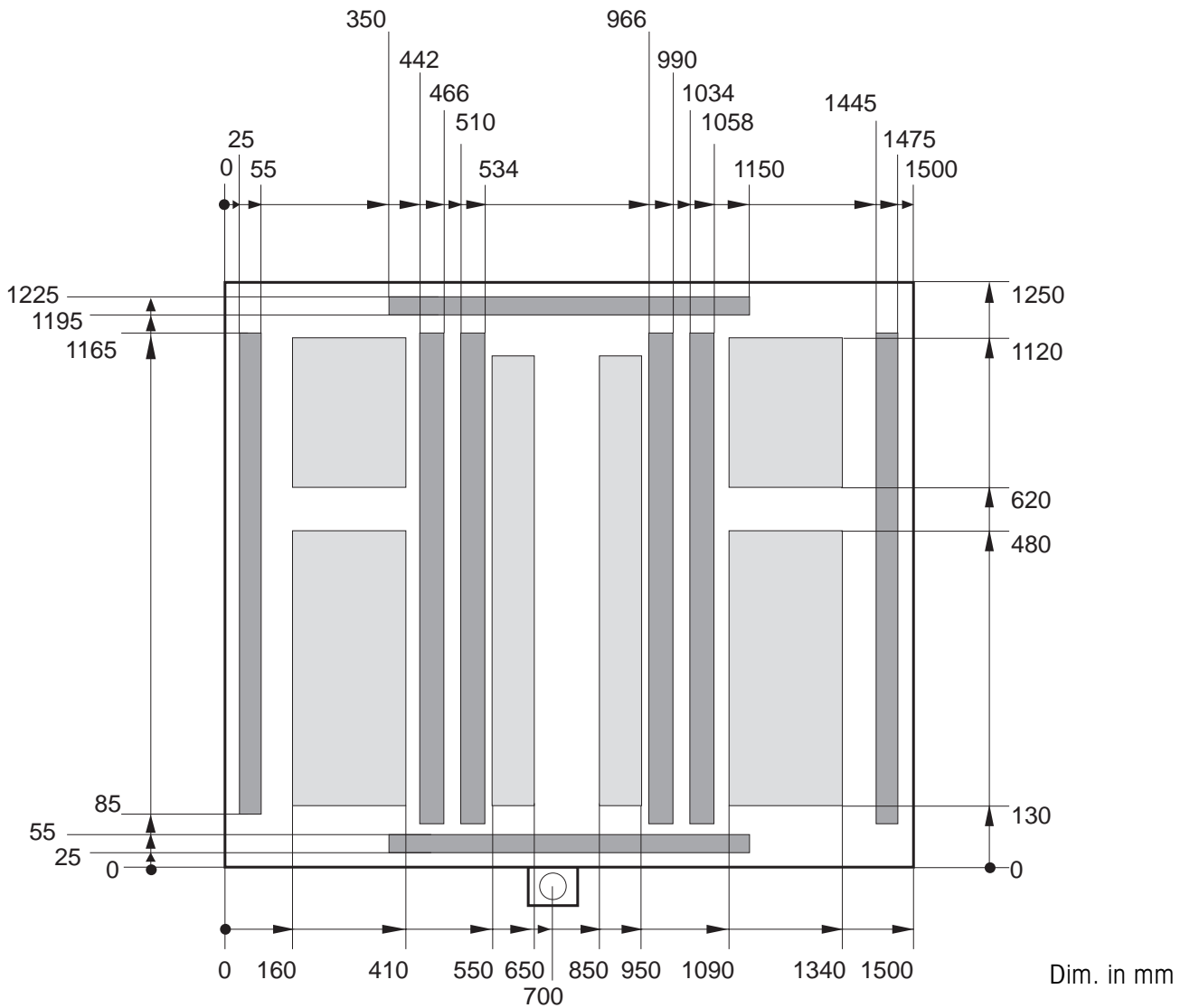
3.3.4 Mounting possibilities for ME1500/ME3000



- Bridge assemblies can be mounted in the shaded areas.
- Recommended mounting type: Bolting on.
Remove the load plate and drill through for this purpose.
- Mounting parts (e.g. bolts and nuts) may extend a maximum of 10 mm beyond the underside of the load plate or load frame.

-  Mounting possibilities on the load plate
-  Mounting possibilities on the load frame

Technical version: 08/00

3.3.5 Mounting possibilities for MES1500/MES3000

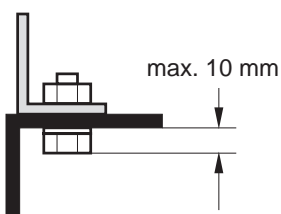
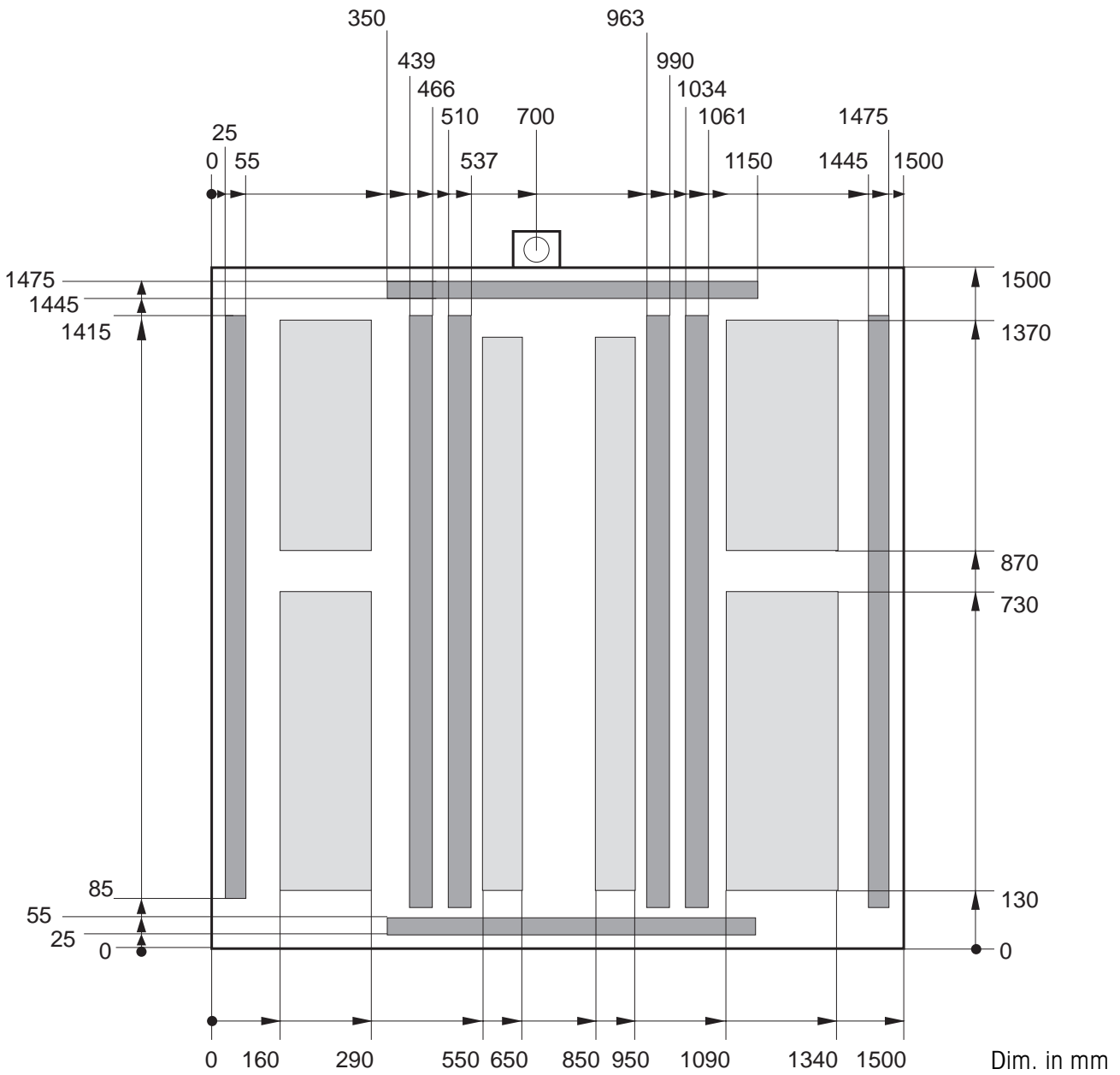

- Bridge assemblies can be mounted in the shaded areas.
- Recommended mounting type: Bolting on.
Remove the load plate and drill through for this purpose.
- Mounting parts (e.g. bolts and nuts) may extend a maximum of 10 mm beyond the underside of the load plate or load frame.



Mounting possibilities on the load plate



Mounting possibilities on the load frame

Technical version: 08/00

3.3.6 Mounting possibilities for ME1500s/ME3000s

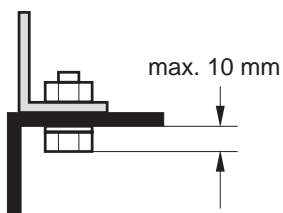
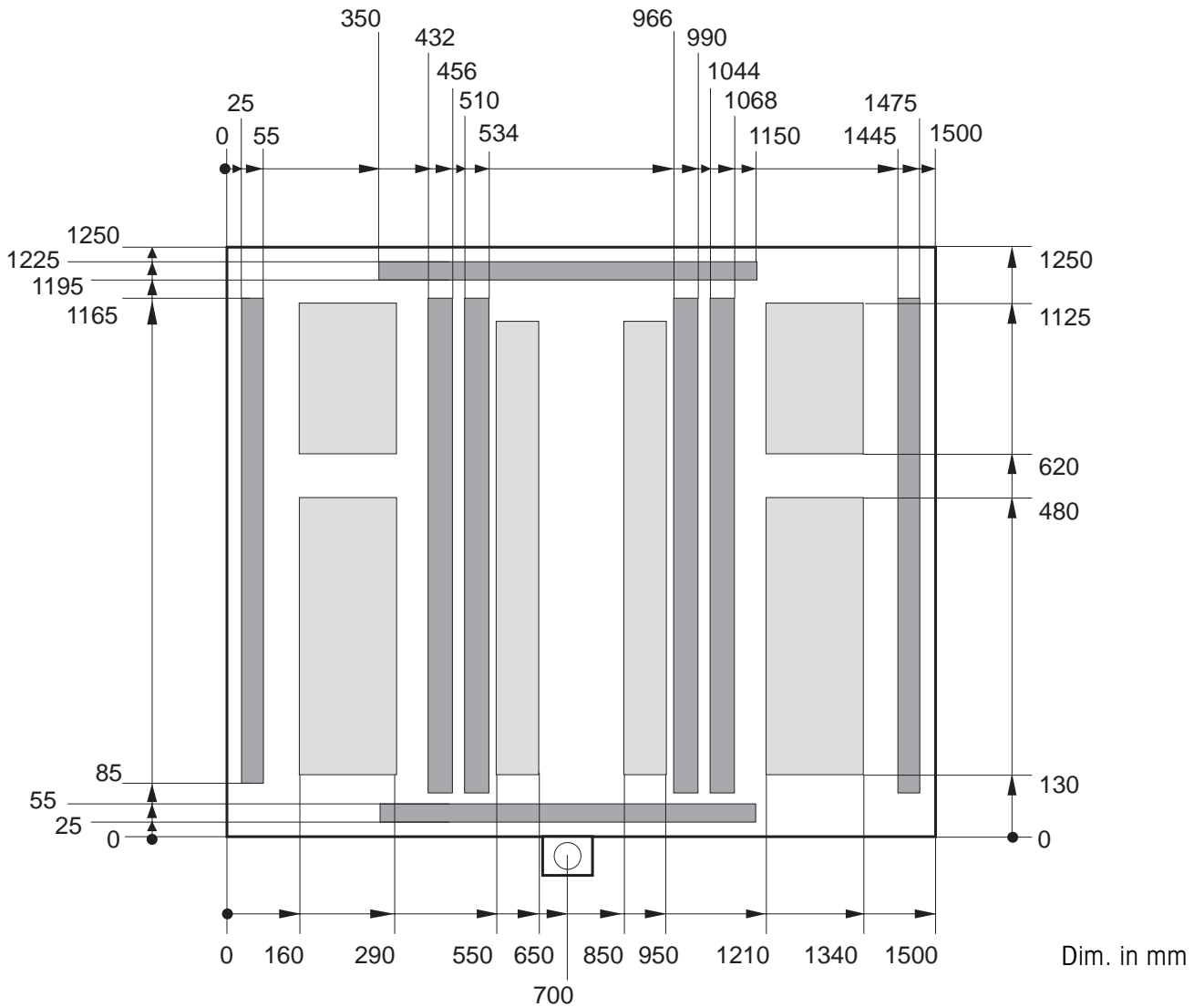

- Bridge assemblies can be mounted in the shaded areas.
- Recommended mounting type: Bolting on.
Remove the load plate and drill through for this purpose.
- Mounting parts (e.g. bolts and nuts) may extend a maximum of 10 mm beyond the underside of the load plate or load frame.



Mounting possibilities on the load plate



Mounting possibilities on the load frame

Technical version: 08/00

3.4 Opening possibilities

3.4.1 Opening possibilities for MC300/MC600

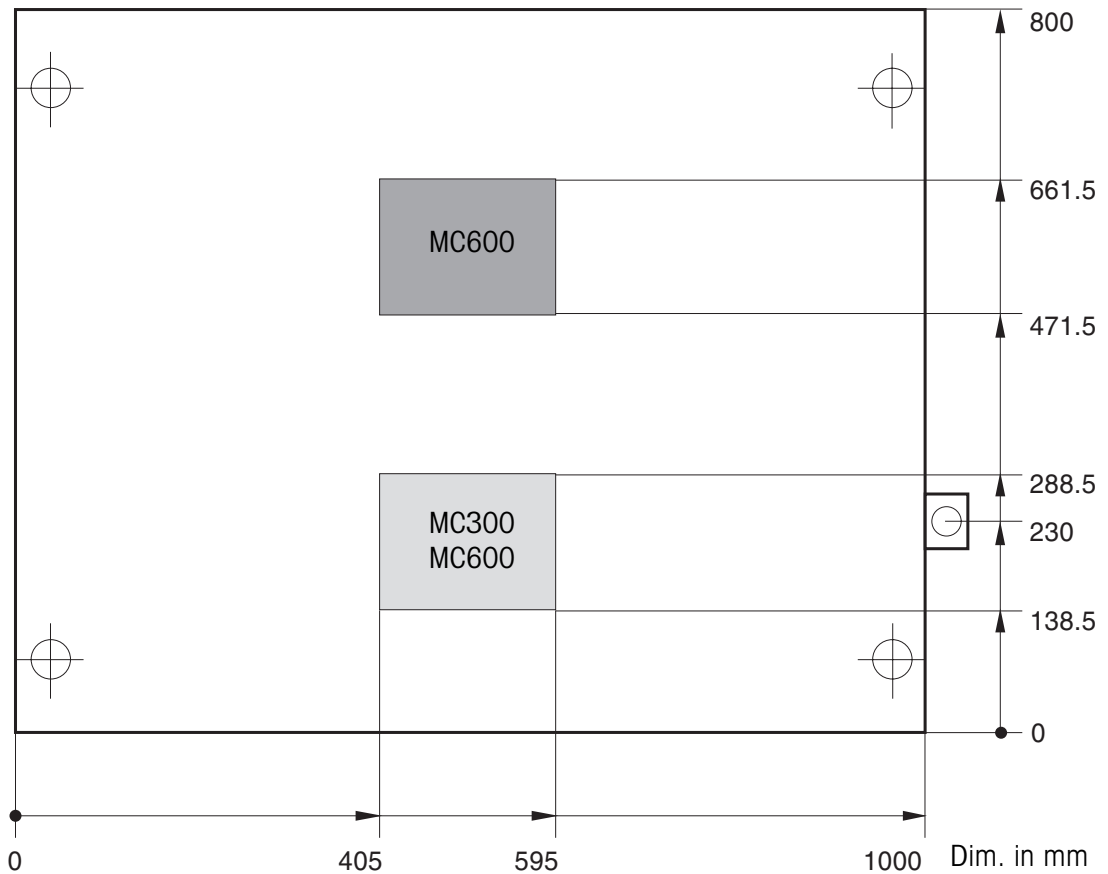

- Openings, e.g. for emptying tank, can be made in the shaded areas.
- Remove the load plate to produce the opening.

Technical version: 08/00

3.4.2 Opening possibilities for MCS300/MCS600

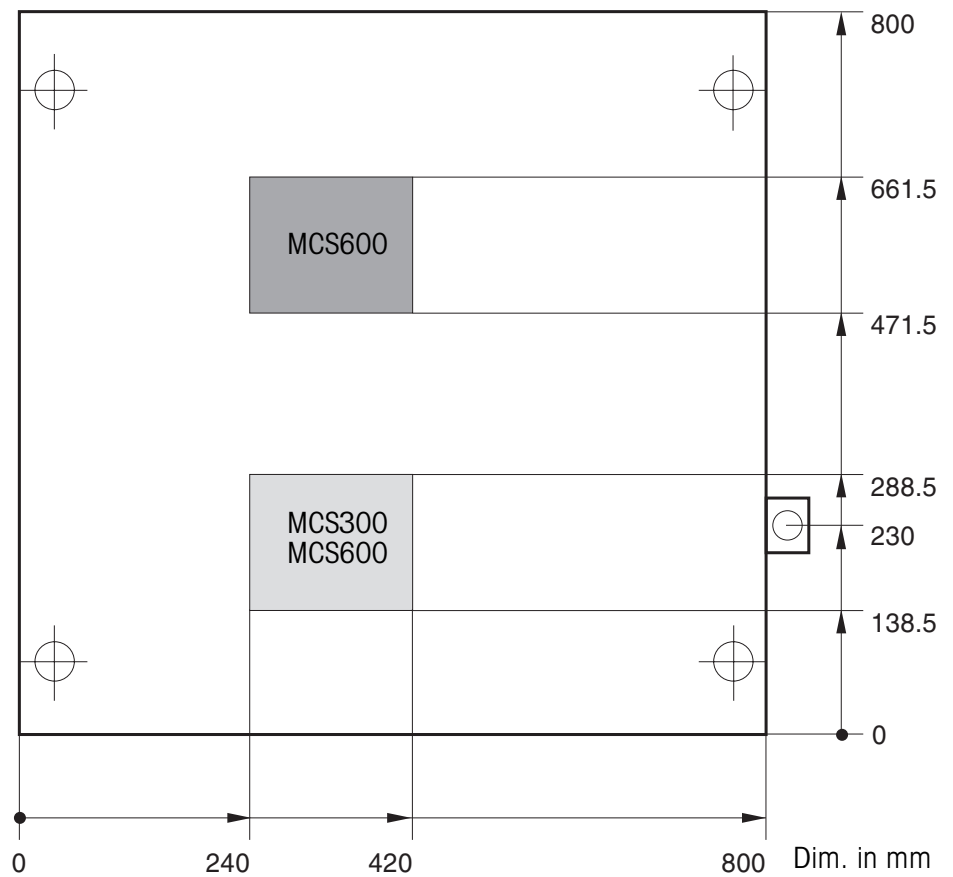

- Openings, e.g. for emptying tank, can be made in the shaded areas.
- Remove the load plate to produce the opening.

Technical version: 08/00

3.4.3 Opening possibilities for MD600/MD1500

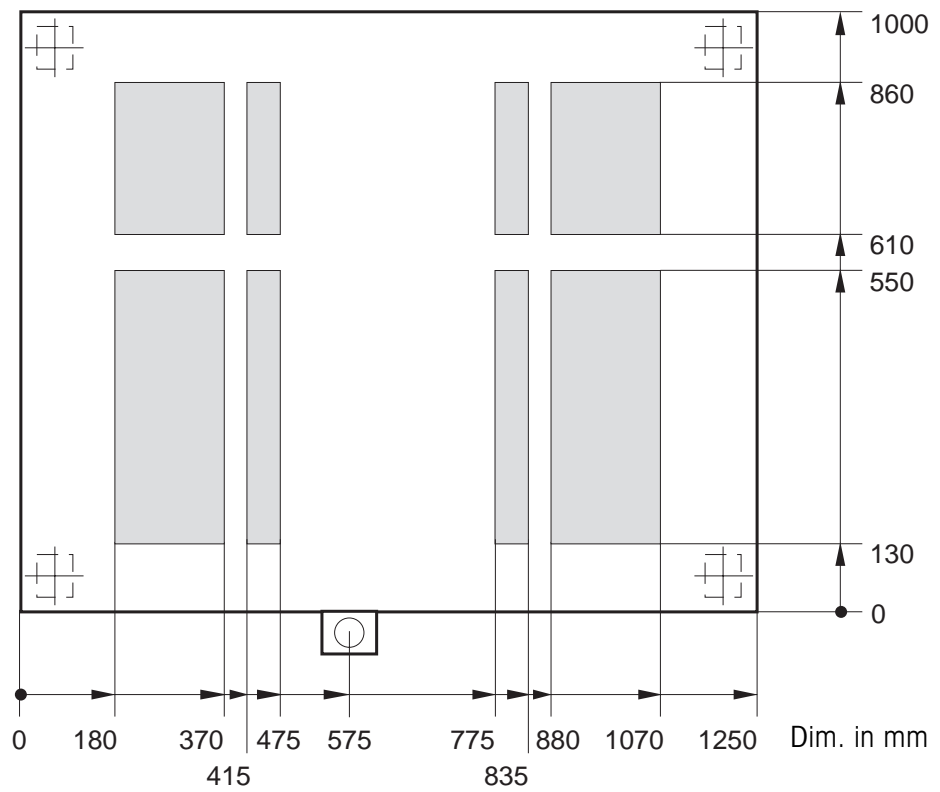

- Openings, e.g. for emptying tank, can be made in the shaded areas.
- Remove the load plate to produce the opening.

Technical version: 08/00

3.4.4 Opening possibilities for ME1500/ME1500s/ME3000/ME3000s

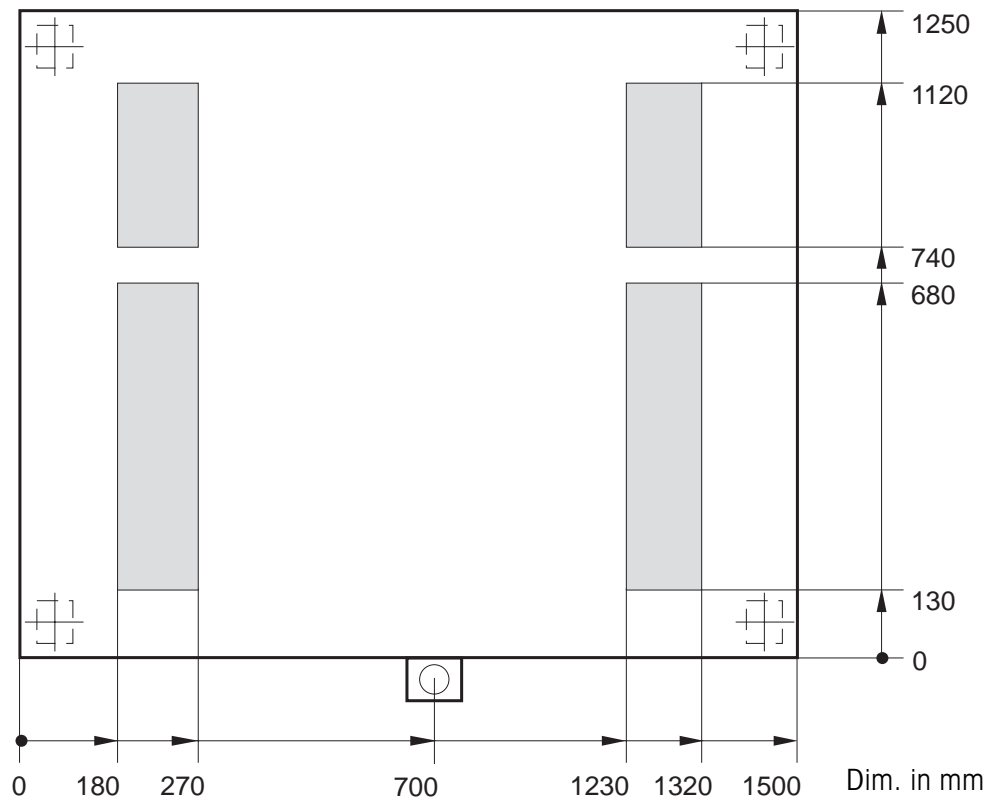

- Openings, e.g. for emptying tank, can be made in the shaded areas.
- Remove the load plate to produce the opening.

Technical version: 08/00

3.4.5 Opening possibilities for MES1500/MES3000

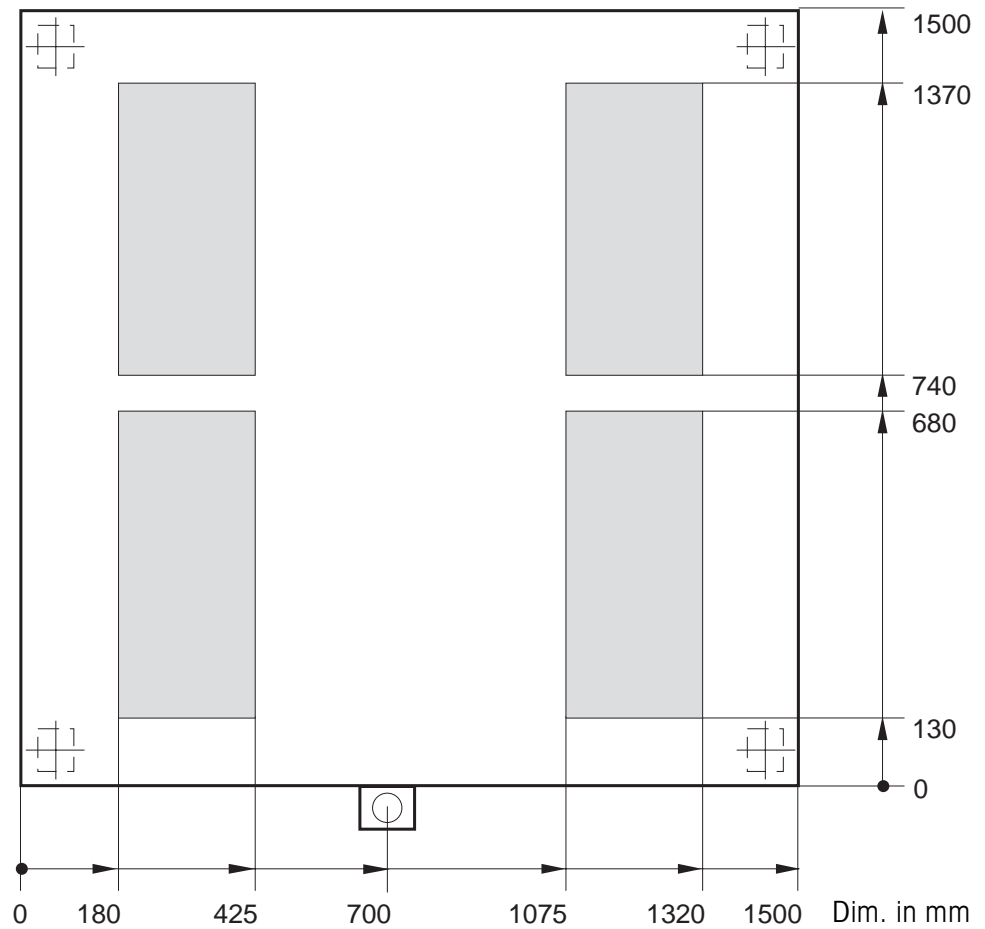

- Openings, e.g. for emptying tank, can be made in the shaded areas.
- Remove the load plate to produce the opening.

Technical version: 08/00

4 Dimensions

Dimensions of MC300/MC600

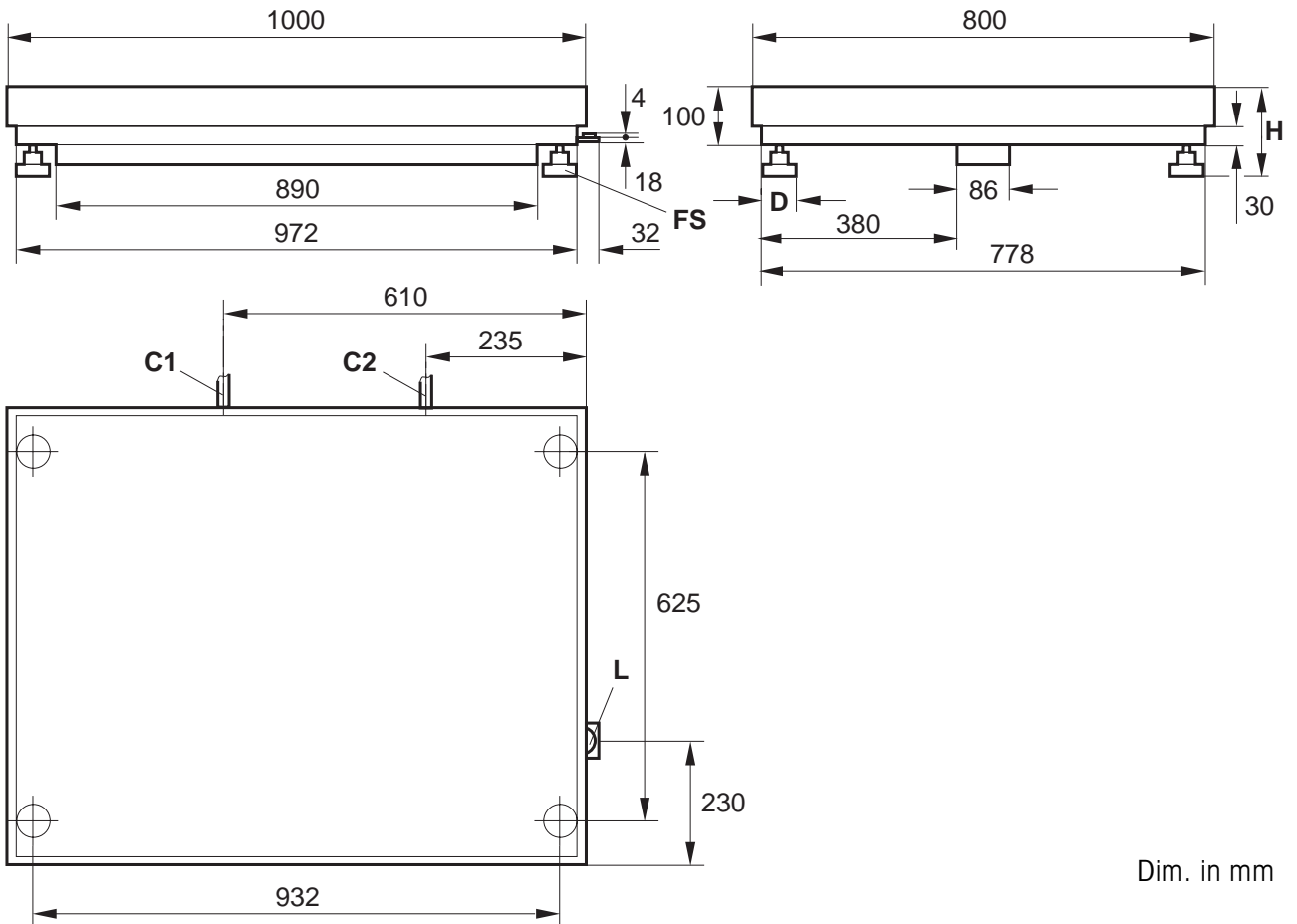

Dim. in mm

- H adjustable with 4 foot bolts
Min. H = 115 mm
Max. H = 140 mm
- FS Foot bolt
Required area D = 40 mm dia.
Spanner size = 19 mm
- L Level indicator
- C1 Cable connection of MC300
- C2 Cable connection of MC600

Technical version: 08/00

Dimensions of MCS300/MCS600

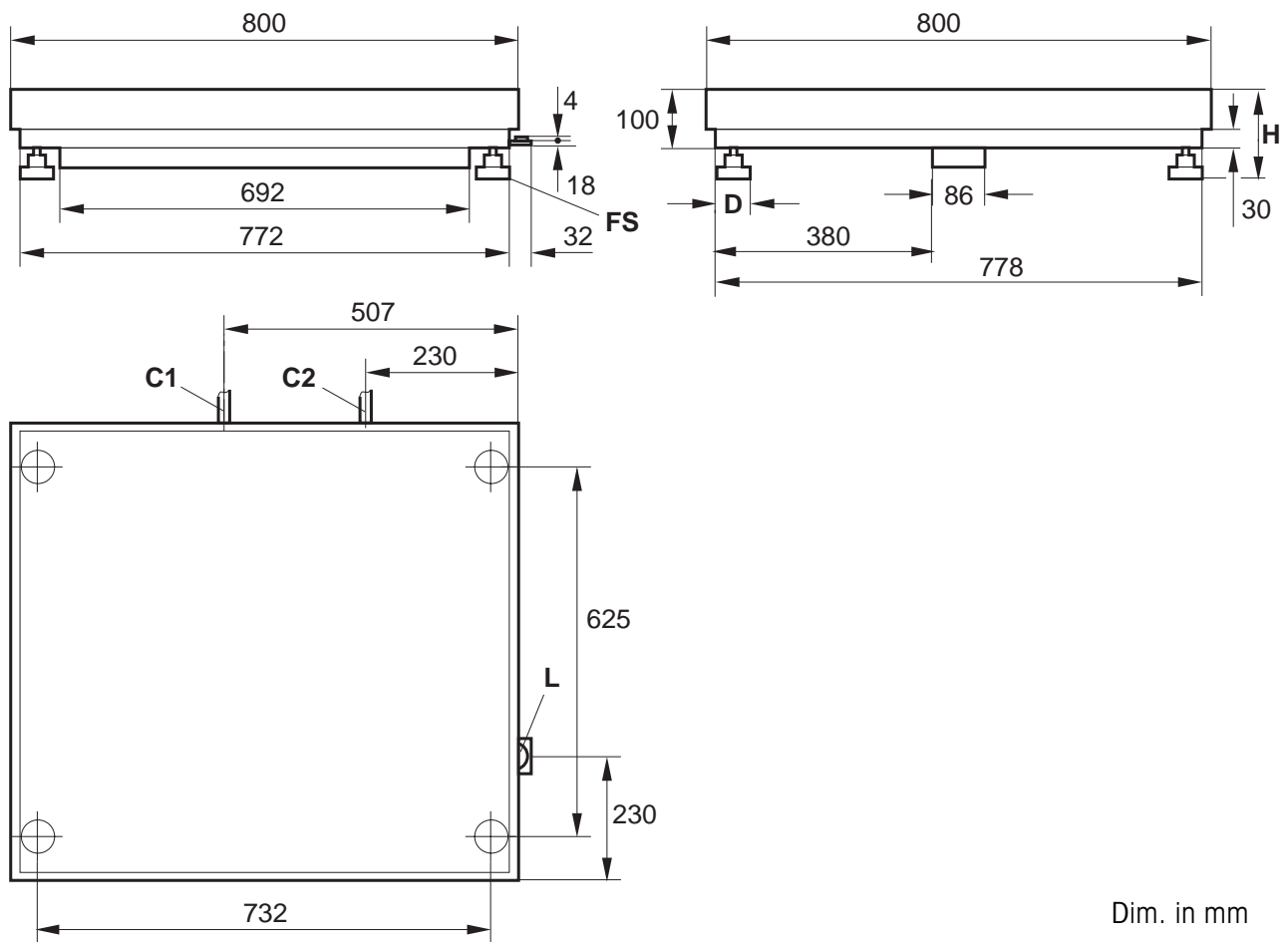

Dim. in mm

- H adjustable with 4 foot bolts
Min. H = 115 mm
Max. H = 140 mm
- FS Foot bolt
Required area D = 40 mm dia.
Spanner size = 19 mm
- L Level indicator
- C1 Cable connection of MCS300
- C2 Cable connection of MCS600

Technical version: 08/00

Dimensions of MD600/MD1500

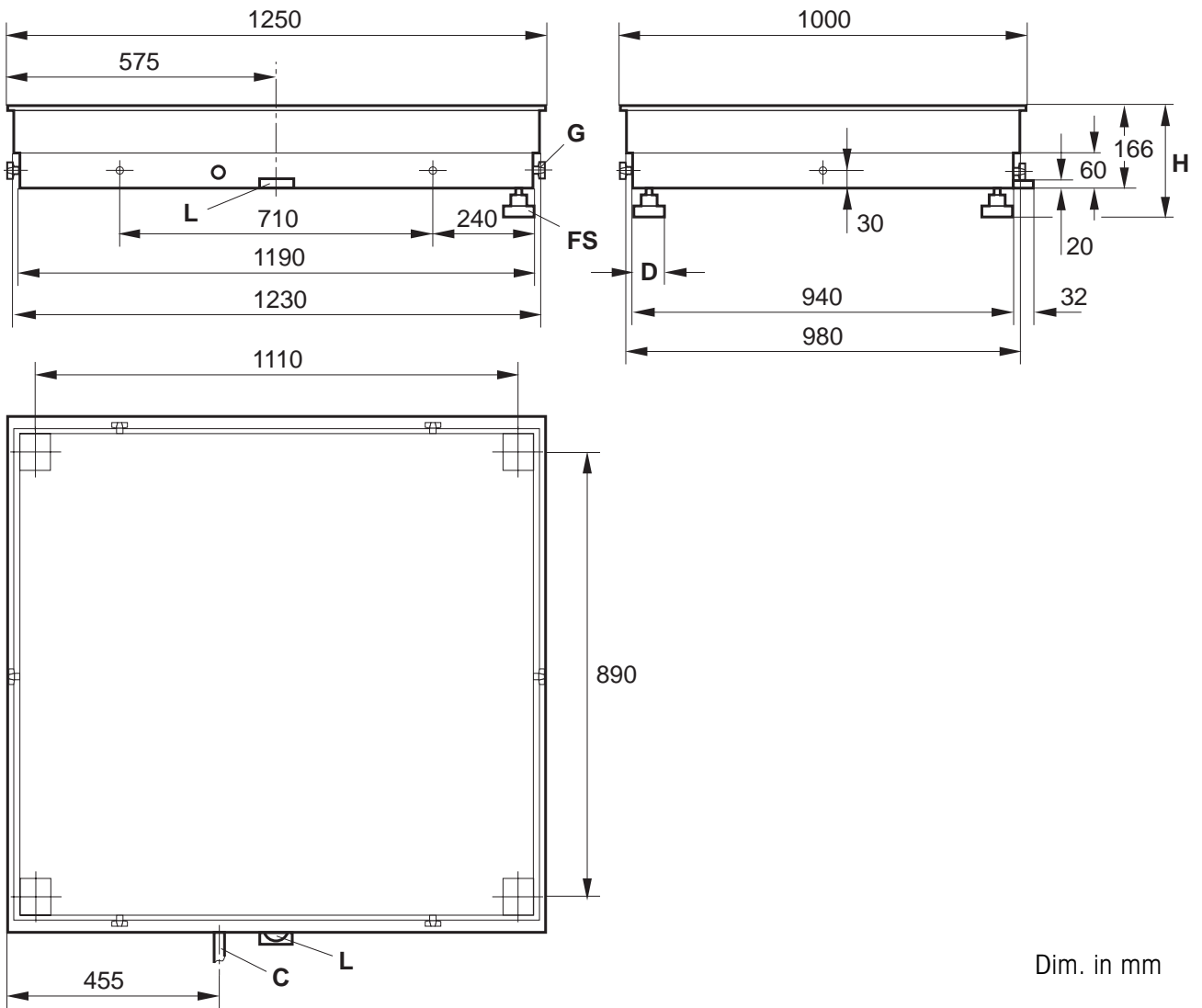

Dim. in mm

- H adjustable with 4 foot bolts
Min. H = 180 mm
Max. H = 205 mm
- FS Foot bolt
Required area D = 60 x 60 mm
Spanner size = 30 mm
- G Thread M12
- L Level indicator
- C Cable connection

Technical version: 08/00

Dimensions of ME1500/ME3000

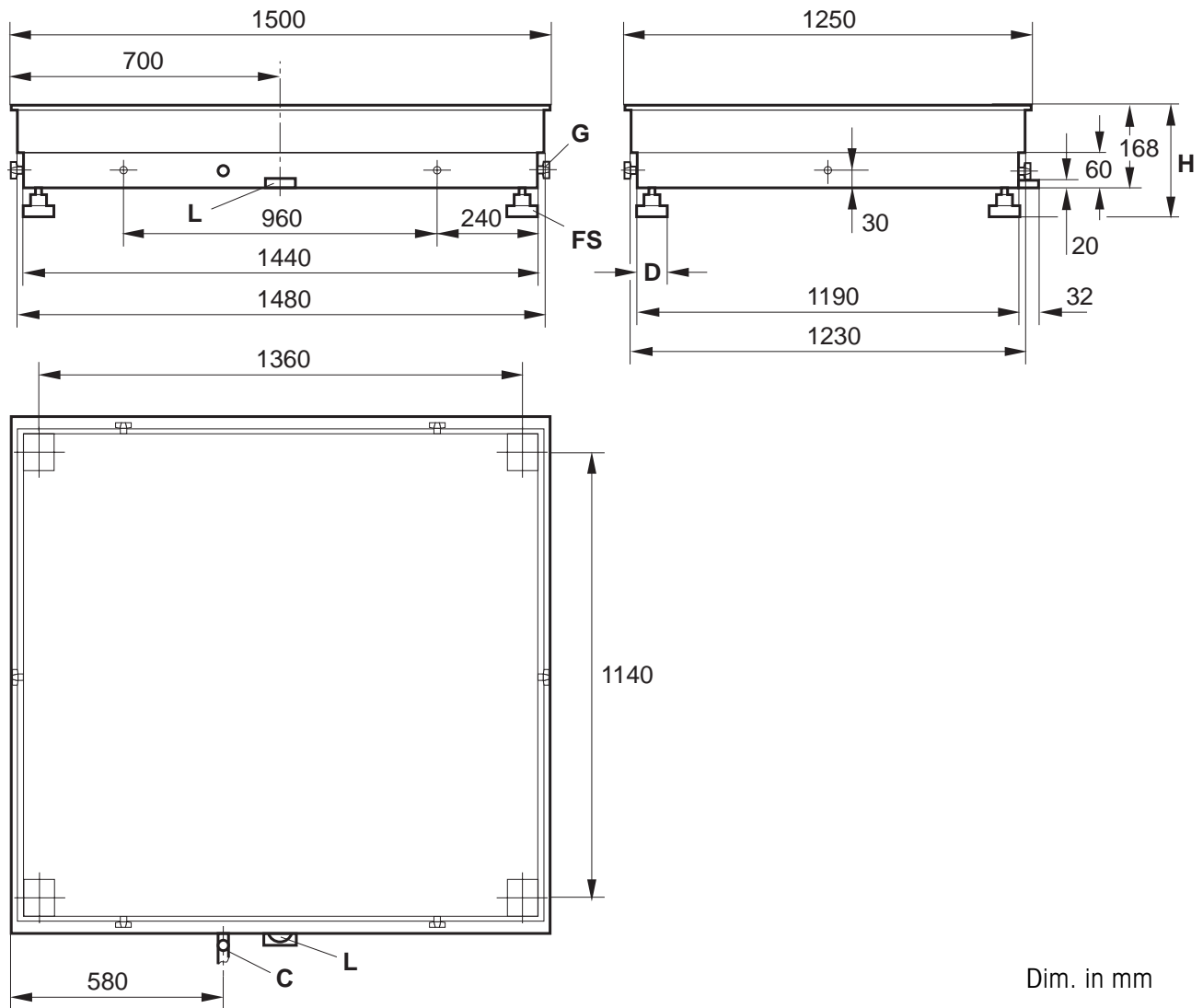

Dim. in mm

- H adjustable with 4 foot bolts
Min. H = 182 mm
Max. H = 207 mm
 - FS Foot bolt
Required area D = 60 x 60 mm
Spanner size = 30 mm
 - G Thread M12
 - L Level indicator
 - C Cable connectio
- Technical version: 08/2000

Dimensions of MES1500/MES3000

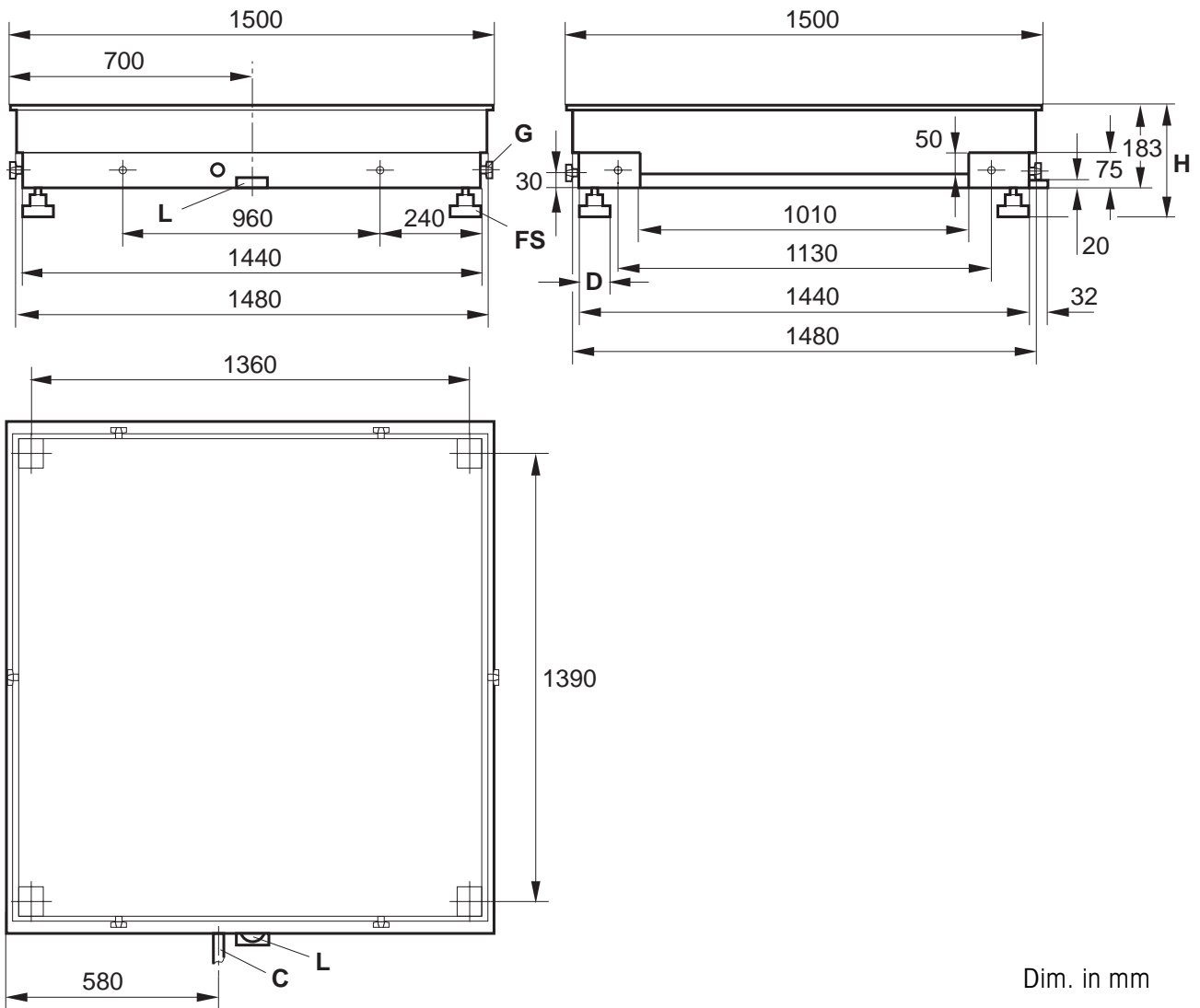

Dim. in mm

- H adjustable with 4 foot bolts
Min. H = 197 mm
Max. H = 222 mm
- FS Foot bolt
Required area D = 60 x 60 mm
Spanner size = 30 mm
- G Thread M12
- L Level indicator
- C Cable connection

Technical version: 08/00



22006498

Subject to technical changes © Mettler-Toledo (Albstadt) GmbH 00/10 Printed in Germany 22006498

Mettler-Toledo (Albstadt) GmbH

D-72458 Albstadt

Tel. ++49-7431-14 0, Fax ++49-7431-14 232

Internet: <http://www.mt.com>