

# Instruction manual

Transmitter Cond Ind 7100e/2(X)H

**METTLER TOLEDO**

A large graphic element in the bottom right corner of the page, consisting of a series of parallel diagonal lines that form a triangular shape pointing towards the top right. The lines are black on a white background.

70098

## Warranty

Defects occurring within 1 years from delivery date shall be remedied free of charge at our plant (carriage and insurance paid by sender).

Subject to change without notice.

## Return of products under warranty

Please contact METTLER TOLEDO's Customer Service Dept. before returning a defective device. Ship the cleaned device to the address you have been given. If the device has been in contact with process fluids, it must be decontaminated/disinfected before shipment. In that case, please attach a corresponding certificate, for the health and safety of our service personnel.

## Disposal

Please observe the applicable local or national regulations concerning the disposal of "waste electrical and electronic equipment".



Mettler-Toledo GmbH, Process Analytics, Industrie Nord,  
CH-8902 Urdorf, Tel. +41 (01) 736 22 11 Fax +41 (01) 736 26 36  
Subject to technical changes. Mettler-Toledo GmbH, 10/05.  
Printed in Germany.

<b>Safety information</b>	<b>5</b>
Intended use	7
Trademarks	7
<b>Certificates</b>	<b>8</b>
EC Declaration of Conformity	8
Conformity with FDA 21 CFR Part 11	9
EC-Type-Examination Certificate	10
1. Supplement to EC-Type-Examination Certificate	13
<b>Overview of Transmitter</b>	<b>15</b>
<b>Assembly</b>	<b>16</b>
Package contents	16
Mounting plan	17
Pipe mounting, panel mounting	18
<b>Installation and connection</b>	<b>20</b>
Information on installation	20, 22
Division 2 wiring	20
Terminal assignments	21
Wiring examples	24
<b>User interface and display</b>	<b>26</b>
Operation: Keypad	28
<b>Safety features</b>	<b>29</b>
Sensocheck, Sensoface sensor monitoring	29
GainCheck device self test	29
Automatic device self-test	29
Hold mode	30
<b>Outputs</b>	<b>31</b>
(Current output / loop current, HART communication, Alarm)	31
<b>Passcodes (factory setting)</b>	<b>32</b>
<b>Configuration</b>	<b>34</b>
Menu structure of configuration	35
Overview of configuration steps	36
Individual settings (for copy)	37
Current output	38

# Contents

Temperature compensation . . . . .	52
Alarm settings . . . . .	54
<b>Passcodes according to FDA 21 CFR Part 11 . . . . .</b>	<b>56</b>
<b>Calibration . . . . .</b>	<b>58</b>
Calibration by input of cell factor . . . . .	60
Calibration with calibration solution . . . . .	62
Product calibration . . . . .	64
Zero calibration in air . . . . .	66
Zero calibration with calibration solution . . . . .	68
Temp probe adjustment . . . . .	70
<b>Measurement . . . . .</b>	<b>70</b>
<b>Diagnostics functions . . . . .</b>	<b>71</b>
Display of output currents . . . . .	71
Display of calibration data (Cal info) . . . . .	71
Sensor monitor . . . . .	71
Display of last error message . . . . .	71
Specify output current . . . . .	72
<b>Cleaning . . . . .</b>	<b>72</b>
<b>Operating states . . . . .</b>	<b>73</b>
<b>Error messages (error codes) . . . . .</b>	<b>74</b>
<b>Sensoface . . . . .</b>	<b>76</b>
<b>Appendix . . . . .</b>	<b>79</b>
Product line and accessories . . . . .	79
Specifications . . . . .	80
Calibration solutions . . . . .	86
Concentration measurement: Ranges . . . . .	88
Concentration curves . . . . .	89
FM Control Drawing . . . . .	94
Explosion protection . . . . .	96
CSA Control Drawing . . . . .	98
<b>Index . . . . .</b>	<b>101</b>

## Safety information

### **Be sure to read and observe the following instructions!**

The device has been designed using state of the art technologies and it complies with the applicable safety regulations. When operating the device, certain conditions may nevertheless lead to danger for the operator or damage to the device.

#### **Caution!**

Commissioning may only be carried out by trained experts. Whenever it is likely that protection has been impaired, the device shall be made inoperative and secured against unintended operation.

The protection is likely to be impaired if, for example:

- the device shows visible damage
- the device fails to perform the intended measurements
- after prolonged storage at temperatures above 70 °C
- after severe transport stresses

Before recommissioning the device, a professional routine test in accordance with EN 61010-1 must be performed. This test should be carried out by the manufacturer.

#### **Caution!**

Before commissioning it must be proved that the device may be connected with other equipment.

# Safety information

## Safety precautions for installation

- The stipulations of EN 60079-10 / EN 60079-14 must be observed during commissioning.
- The **Transmitter Cond Ind 7100e/2H** is approved for measurements in FM Class 1 Div 2.
- The **Transmitter Cond Ind 7100e/2XH** is approved for operation in the following locations: ATEX, FM Zone 1 with measurement in Zone 0, and FM Class I Div 1.

## Connection to supply units

- **Transmitter Cond Ind 7100e/2H:** Before connecting this device to a supply unit, make sure that its output voltage cannot exceed 30 V DC. Do not use alternating current or mains power supply!
- **Transmitter Cond Ind 7100e/2XH:** This device may only be connected to an explosion-proof power supply unit (for input ratings refer to annex of EC-Type-Examination Certificate). Before commissioning it must be made sure that the connections to other equipment such as power supply unit and cables are intrinsically safe.

Terminals:

suitable for single wires / flexible leads up to 2.5 mm<sup>2</sup> (AWG 14)

## Note for cleaning in a hazardous location

In hazardous locations the transmitter may only be cleaned with a damp cloth to prevent electrostatic discharge.

## Intended use

The Transmitter Cond Ind 7100e/2(X) is used for measurement of electrical conductivity and temperature in liquids in the field of biotechnology, chemical and pharmaceutical industry, pulp and paper, as well as industry, environment, food processing, and sewage treatment.

The rugged molded enclosure can be wall or pipe mounted or fixed into a control panel.

The protective hood provides additional protection against direct weather exposure and mechanical damage.

The transmitter has been designed for application with electrodeless sensors, particularly for the sensors of the InPro 7250 series.

- The **Transmitter Cond Ind 7100e/2H** is approved for measurements in FM Class 1 Div 2.
- The **Transmitter Cond Ind 7100e/2XH** is approved for operation in the following locations: ATEX, FM Zone 1 with measurement in Zone 0, and FM Class I Div 1.

## Trademarks

The following names are registered trademarks. For practical reasons they are shown without trademark symbol in this manual.

Sensoface

Sensocheck

GainCheck

InPro® is a registered trademark of Mettler-Toledo.

HART® is a registered trademark of the HART Communication Foundation (HCF).

# EC Declaration of Conformity



## Declaration of conformity Konformitätserklärung Déclaration de conformité



**We/Wir/Nous**

**Mettler-Toledo GmbH, Process Analytics**  
Im Hackacker 15  
8902 Urdorf  
Switzerland

**Description**

**Beschreibung/Description**

declare under our sole responsibility that the product,  
erklären in alleiniger Verantwortung, dass dieses Produkt,  
déclarons sous notre seule responsabilité que le produit,

**Condi 7100/2(X)H**

to which this declaration relates is in conformity with the following standard(s) or other  
normative document(s).

auf welches sich diese Erklärung bezieht, mit der/den folgenden Norm(en) oder  
Richtlinie(n) übereinstimmt.

auquel se réfère cette déclaration est conforme à la (aux) norme(s) ou au(x)  
document(s) normatif(s).

**Explosionsschutzrichtlinie**

**Explosion Protection /**

**Protection contre les explosions**

**94/9/EG**

**Physikalisch-Technische Bundesanstalt PTB**

**PTB 00 ATEX 2172**

**D-38116 Braunschweig, PTB 0102**

**EMC Directive/EMV-Richtlinie**

**Directive concernant la CEM**

**89/336/EWG**

**SR 734.5, VEMV**

**Low-voltage directive/Nieder-**

**spannungs-Richtlinie/**

**Directive basse tension**

**73/23/EWG**

**SR 734.26, NEV**

**Place and Date of issue**

**Ausstellungsort / - Datum Lieu  
et date d'émission**

**Urdorf, August 3, 2004**

Mettler-Toledo GmbH, Process Analytics

Waldemar Rauch  
General Manager PO Urdorf

Christian Zwicky  
Head of Marketing

**Norm/Standard/Standard**

**EN 50 014**

**EN 50 020**

**EN 61326/ VDE 0843 Teil 20**

**EN 61010 Teil/ VDE 0411 Teil 1**

**METTLER TOLEDO**

Artikel Nr.: 52960319 KE

Datenname: 52960319KE-Cond7100e-2(X)H-Internet-3.doc

Version b

502 der Gesellschaft: Mettler-Toledo GmbH, Im Langacker, CH-8606 Greifensee



## Conformity with FDA 21 CFR Part 11

In their directive “Title 21 Code of Federal Regulations, 21 CFR Part 11, Electronic Records; Electronic Signatures” the US American health agency FDA (Food and Drug Administration) regulates the production and processing of electronic documents for pharmaceutical development and production. This results in requirements for measuring devices used for corresponding applications. The following features ensure that the measuring devices of the Transmitter Cond Ind 7100e/2(X)H Series meet the demands of FDA 21 CFR Part 11:

### Electronic Signature

Access to the device functions is regulated and limited by individually adjustable codes – “Passcodes” (for Passcode Editor see Page 56, overview of factory settings on back of manual). This prevents unauthorized modification of device settings or manipulation of the measurement results. Appropriate use of these passcodes makes them suitable as electronic signature.

### Audit Trail

Every (manual) change of device settings can be automatically documented. For that purpose, each change is marked by a “Configuration Change Flag”, which can be interrogated and documented via HART communication. Then the changed device settings/parameters can also be retrieved and documented via HART communication.

# EC-Type-Examination Certificate



Translation

## EC-TYPE EXAMINATION CERTIFICATE

(1)

(2) Equipment or Protective System intended for use in potentially explosive atmospheres - **Directive 94/9/EC**



(3) EC-Type Examination Certificate Number

**TÜV 99 ATEX 1434**

(4) Equipment or Protective System: transmitter type Cond I7100/2X\*

(5) Manufacturer: Mettler Toledo GmbH

(6) Address: CH-Urdorf, Im Hackacker 15

(7) This equipment or protective system and any acceptable variation thereto is specified in the schedule to this certificate and the documents therein referred to.

(8) The TÜV Hannover/Sachsen-Anhalt e.V., TÜV Certification Body N° 0032 in accordance with Article 9 of the Council Directive 94/9/EC of March 23, 1994, certifies that this equipment or protective system has been found to comply with the Essential Health and Safety Requirements relating to the design and construction of equipment and protective systems intended for use in potentially explosive atmospheres given in Annex II to the Directive.

The examination and test results are recorded in confidential report N° 99/PX10691.

(9) Compliance with the Essential Health and Safety Requirements has been assured by compliance with:

**EN 50 014:1997**

**EN 50 020:1994**

(10) If the sign "X" is placed after the certification number, it indicates that the equipment or protective system is subject to special conditions for safe use specified in the schedule to this certificate.

(11) This EC-TYPE EXAMINATION CERTIFICATE relates only to the design and construction of the specified equipment or protective system. If applicable, further requirements of this Directive apply to the manufacture and supply of this equipment or protective system.

(12) The marking of the equipment or protective system shall include the following:

II 2 (1) G EEx ib [ia] IIC T6

TÜV Hannover/Sachsen-Anhalt e.V.  
TÜV CERT-Zertifizierungsstelle  
Am TÜV 1  
D-30519 Hannover

Hannover, 1999-06-04

  
Head of the  
Certification Body



9 9 9 9 9 9 9 9

This certificate may only be reproduced without any change, schedule included.  
Excerpts or changes shall be allowed by the TÜV Hannover/Sachsen-Anhalt e.V.

page 1/3



## (13) SCHEDULE

## (14) EC-TYPE EXAMINATION CERTIFICATE N° TÜV 99 ATEX 1434

## (15) Description of equipment or protective system

The transmitter type Cond I7100/2X\* is used for the recognition and processing of electrochemical quantities.

The maximum permissible ambient temperature is 55°C.

## Electrical data

Current loop..... in type of protection "Intrinsic Safety" EEx ib IIC  
(terminals 10, 11) only for the connection to a certified intrinsically safe circuit with the following maximum values:

$$\begin{aligned}U_0 &= 30 \text{ V} \\I_0 &= 100 \text{ mA} \\P_0 &= 0.8 \text{ W}\end{aligned}$$

$$\begin{aligned}\text{effective internal capacitance } C_i &= 20 \text{ nF} \\ \text{effective internal inductance } L_i &= 0.2 \text{ mH}\end{aligned}$$

Conductivity measuring loop.... in type of protection "Intrinsic Safety" EEx ia IIC resp. EEx ib IIC  
(terminals 1, 2, 3, 4, 5)

Maximum values:

$$\begin{aligned}U_0 &= 7.5 \text{ V} \\I_0 &= 63 \text{ mA} \\P_0 &= 80 \text{ mW} \\R_0 &= 80 \text{ }\Omega\end{aligned}$$

Characteristic: linear

$$\text{effective internal capacitance } C_i = 3 \text{ nF}$$

The effective internal inductance is negligibly small.

$$\begin{aligned}\text{max. permissible external capacitance } C_o &= 11.1 \text{ }\mu\text{F} \\ \text{max. permissible external inductance } L_o &= 9 \text{ mH}\end{aligned}$$

or for the connection to the electrodeless conductivity sensor type SE654 X resp. type 871EC-SPO  
Maximum cable length: 30 m

Temperature measuring loop.... in type of protection "Intrinsic Safety" EEx ia IIC  
(terminals 7, 8)

Maximum values:

$$\begin{aligned}U_0 &= 5 \text{ V} \\I_0 &= 3.5 \text{ mA} \\P_0 &= 5 \text{ mW} \\R_0 &= 1590 \text{ }\Omega\end{aligned}$$

Characteristic: linear

$$\text{effective internal capacitance } C_i = 250 \text{ nF}$$

The effective internal inductance is negligibly small.



max. permissible external capacitance  $C_o = 100 \mu\text{F}$   
max. permissible external inductance  $L_o = 1 \text{ H}$

EP for the connection to the equipotential bonding system  
(Terminal 9)

The current loop is safely separated from the conductivity measuring loop and the temperature measuring loop up to a voltage of 60 V. The conductivity measuring loop and the temperature measuring loop are galvanically connected.

(16) Test documents are listed in the test report No. 99/PX10691.

(17) Special condition for safe use  
none.

(18) Essential Health and Safety Requirements  
no additional ones

# 1. Supplement to EC-Type-Examination Certificate



Translation  
**1. SUPPLEMENT to**

**EC-TYPE EXAMINATION CERTIFICATE No. TÜV 99 ATEX 1434**

Equipment: transmitter type Cond Ind 7100e/2X\*  
 Manufacturer: Mettler Toledo GmbH  
 Address: CH-8902 Urdorf  
 Im Hackacker 15

In the future, the transmitter type CondI 7100/2X\* may also be operated according to the test documents listed in the test report.  
 The changes refer to the electrical data of the transmitter as well as to the type designation.  
 For the transmitter according to this 1. supplement this reads Cond Ind 7100e/2X\*.

Electrical data

Conductivity measuring loop ..... in type of protection "Intrinsic Safety" EEx ia IIC  
 (terminals 1, 2, 3, 4, 5, 6)  
 Maximum values:  
 $U_o = 8 \text{ V}$   
 $I_o = 99 \text{ mA}$   
 $P_o = 124 \text{ mW}$   
 $R_i = 50,7 \ \Omega$   
 Characteristic: linear  
 effective internal capacitance  $C_i = 3 \text{ nF}$   
 The effective internal inductance is negligibly small.  
 max. permissible external capacitance  $C_e = 8,4 \ \mu\text{F}$   
 max. permissible external inductance  $L_e = 4 \text{ mH}$

Temperature measuring loop ..... in type of protection "Intrinsic Safety" EEx ia IIC  
 (terminals 7, 8)  
 Maximum values:  
 $U_o = 5 \text{ V}$   
 $I_o = 3,5 \text{ mA}$   
 $P_o = 5 \text{ mW}$   
 $R_i = 1590 \ \Omega$   
 Characteristic: linear  
 effective internal capacitance  $C_i = 250 \text{ nF}$   
 The effective internal inductance is negligibly small.  
 max. permissible external capacitance  $C_e = 100 \ \mu\text{F}$   
 max. permissible external inductance  $L_e = 1 \text{ H}$

1. Supplement to EC-Type Examination Certificate No. TÜV 99 ATEX 1434

Conductivity/temperature measuring loop ..... in type of protection "Intrinsic Safety" EEx ia IIC (terminals 1, 2, 3, 4, 5, 6, 7, 8)  
Maximum values:  
 $U_e = 8 \text{ V}$   
 $I_e = 102.5 \text{ mA}$   
 $P_c = 129 \text{ mW}$   
 $R_i = 49.1 \Omega$   
Characteristic: linear  
effective internal capacitance  $C_i = 250 \text{ nF}$   
The effective internal inductance is negligibly small.  
max. permissible external capacitance  $C_e = 8.4 \mu\text{F}$   
max. permissible external inductance  $L_e = 4 \text{ mH}$

The conductivity measuring loop and the temperature measuring loop are galvanically connected.

The transmitters type CondI 7100/2X\* and type Cond Ind 7100e/2X\* also meet the requirements of EN 50 014:1997 +A1+A2 EN 50 020:2002

All other details remain unchanged for this 1. supplement.

(16) The test documents are listed in the test report N° 05 YEX 552150.

(17) Special conditions for safe use  
none

(18) Essential Health and Safety Requirements  
no additional ones

TÜV NORD CERT GmbH & Co. KG  
Am TÜV 1  
D-30519 Hannover  
Tel.: +49 511 986-1470  
Fax: +49 511 986-1590

Hannover, 2005-07-20



Head of the  
Certification Body

# Overview of Transmitter

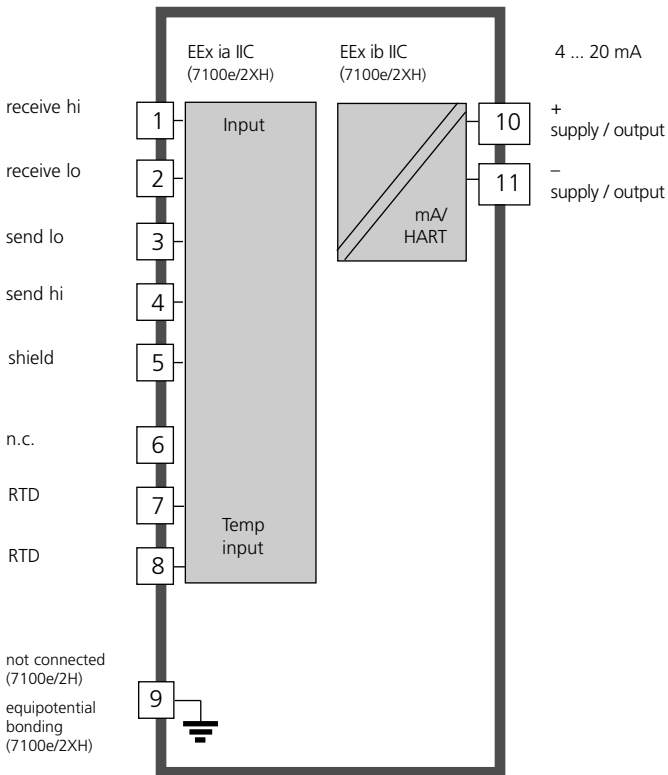

# Assembly

## Package contents

Check the shipment for transport damage and completeness. The package should contain:

- Front unit
- Lower case
- Bag containing small parts
- Instruction manual
- Specific test report

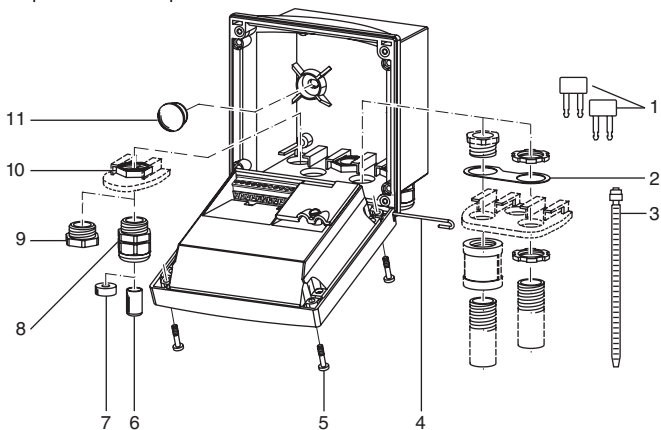

- |   |  |    |  |
|---|--|----|--|
| 1 | Jumper (2 piece)   | 6  | Sealing inserts (1 piece)                                      |
| 2 | Washer (1 piece), for conduit mounting: place washer between enclosure and nut | 7  | Rubber reducer (1 piece)                                       |
| 3 | Cable ties (3 pieces)  | 8  | Cable glands (3 pieces)  |
| 4 | Hinge pin (1 piece), insertable from either side                               | 9  | Filler plugs (3 pieces)  |
| 5 | Enclosure screws (4 pieces)  | 10 | Hexagon nuts (5 pieces)  |
|   |  | 11 | Sealing plugs (2 pieces), for sealing in case of wall mounting |

Fig.: Assembling the enclosure



## Mounting plan

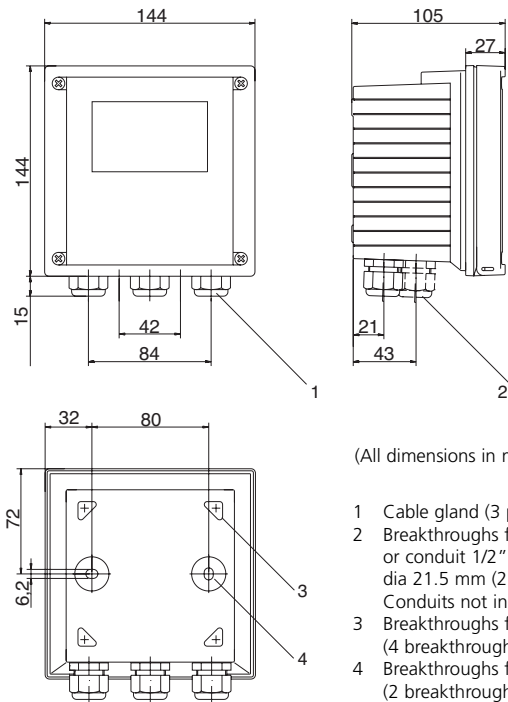
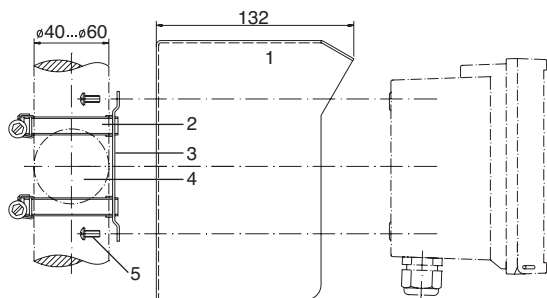

Fig.: Mounting plan

## Pipe mounting, panel mounting



- 1 Protective hood (if required)
- 2 Hose clamps with worm gear drive to DIN 3017 (2 pieces)
- 3 Pipe-mount plate (1 piece)
- 4 For vertical or horizontal posts or pipes
- 5 Self-tapping screws (4 pieces)

(All dimensions in mm)

Fig.: Pipe-mount kit

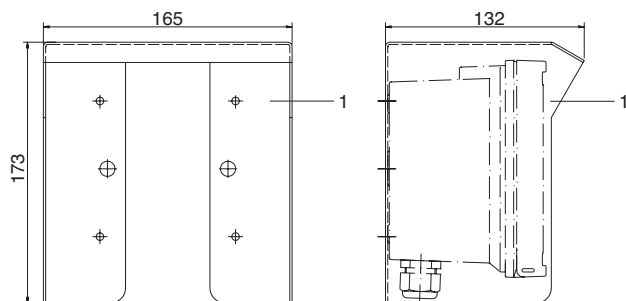
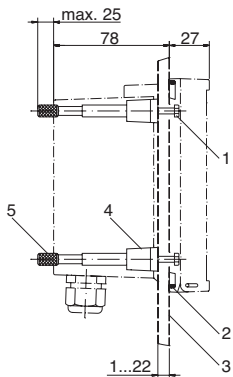

Fig.: Protective hood for wall and pipe mounting



- 1 Screws (4 pieces)
- 2 Gasket (1 piece)
- 3 Panel
- 4 Span pieces (4 pieces)
- 5 Threaded sleeves (4 pieces)

Panel cutout 138 x 138 mm  
(DIN 43700)

(All dimensions in mm)

Fig.: Panel-mount kit

# Installation and connection

## Information on installation

- Installation may only be carried out by trained experts in accordance with this instruction manual and as per applicable local and national codes.
- Be sure to observe the technical specifications and input ratings.
- Be sure not to notch the conductor when stripping the insulation.
- When commissioning, a complete configuration must be carried out by the system administrator.

## Connection to supply units

- **Transmitter Cond Ind 7100e/2H:** Before connecting this device to a supply unit, make sure that its output voltage cannot exceed 30 V DC. Do not use alternating current or mains power supply!
- **Transmitter Cond Ind 7100e/2XH:** This device may only be connected to an explosion-proof power supply unit (for input ratings refer to annex of EC-Type-Examination Certificate).

**Terminals:** suitable for single wires / flexible leads up to 2.5 mm<sup>2</sup> (AWG 14)

## Warning!

Additional safety precautions have to be taken for applications in hazardous locations to CSA!  
(See Pg 97 et seq.)

## Division 2 wiring



The connections to the transmitter must be installed in accordance with the National Electric Code (ANSI-NFPA 70) Division 2 hazardous (classified) location non-incendive wiring techniques.

**FM Control Drawing:** Refer to page 94.

# Terminal assignments

+	11	10	9	8	7	6	5	4	3	2	1
HART-E	4 to 20 mA	+	do not connect	RTD	RTD	n.c.	shield	hi	lo	lo	hi
supply/output				temp			electrodeless conductivity sensor	send		receive	

 NI, CLI, DIV2, GRP A, B, C, D T4, TYPE 2  
 HAZARDOUS LOCATION per Control Drawing 194.320-190

**WARNING** -EXPLOSION HAZARD- DO NOT DISCONNECT EQUIPMENT UNLESS POWER HAS BEEN SWITCHED OFF OR THE AREA IS KNOWN TO BE NON-HAZARDOUS.  
**WARNING** -BONDING BETWEEN CONDUIT IS NOT AUTOMATIC AND MUST BE PROVIDED AS PART OF THE INSTALLATION. SEE INSTALLATION INSTRUCTIONS.

**AVERTISSEMENT** -RISQUE D'EXPLOSION- AVANT DE DECONNECTER L'EQUIPEMENT, COUPER LE COURANT OU S'ASSURER QUE L'EMPLACEMENT EST DESIGNÉ NON DANGEREUX.





  0499  
 00000



Fig.: Terminal assignments Transmitter Cond Ind 7100 e/2H

+	11	10	9	8	7	6	5	4	3	2	1
HART-E	4 to 20 mA	+	⏏	RTD	RTD	n.c.	shield	hi	lo	lo	hi
supply/output				temp			electrodeless conductivity sensor	send		receive	

 T:V 99 ATEX 1434 CH-8902 Urdorf  
 II 2(1) G EEx ib [Ia] IIC T6 Switzerland  
 Electrical data see EC-Type Examination Certificate

 IS, CLI, DIV1, GRP A, B, C, D T4, Entity, Type 2  
 NI, CLI, DIV2, GRP A, B, C, D T4, Type 2  
 IS, CLI, DIV1, GRP A, B, C, D T4 Ex ib [Ia] IIC T4  
 CLI, DIV2, GRP A, B, C, D T4 Ex nAL [L] IIC T4  
 CSA 2005.1662790

**BONDING BETWEEN CONDUIT IS NOT AUTOMATIC AND MUST BE PROVIDED AS PART OF THE INSTALLATION. SEE INSTALLATION INSTRUCTIONS.**

  0499  
 00000

HAZARDOUS LOCATION per Control Drawing 194.320-190 Tamb -20 to +55 °C

Fig.: Terminal assignments Transmitter Cond Ind 7100 e/2XH

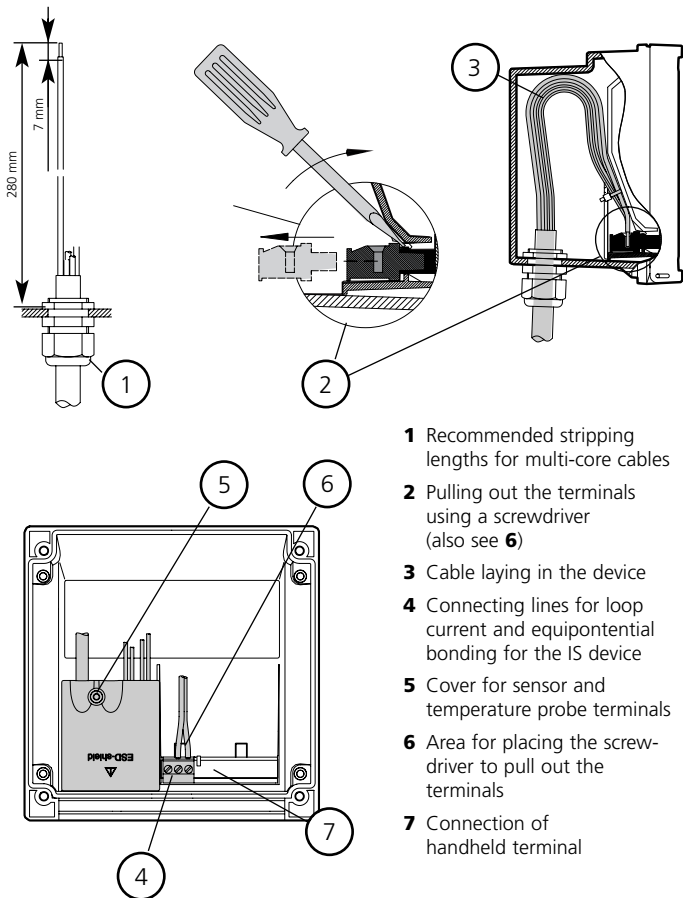

- 1** Recommended stripping lengths for multi-core cables
- 2** Pulling out the terminals using a screwdriver (also see **6**)
- 3** Cable laying in the device
- 4** Connecting lines for loop current and equipotential bonding for the IS device
- 5** Cover for sensor and temperature probe terminals
- 6** Area for placing the screwdriver to pull out the terminals
- 7** Connection of handheld terminal

Fig.: Information on installation, rear side of device



# Wiring examples

## InPro 7250 ST sensor

### Cond Ind 7100e/2(X)H

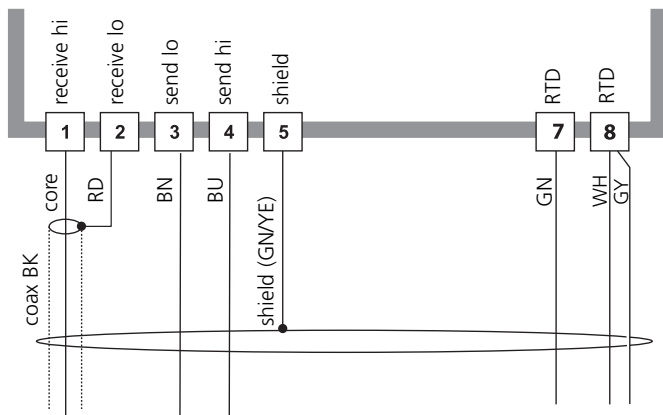



**InPro 7250 HT sensor**

**Cond Ind 7100e/2(X)H**

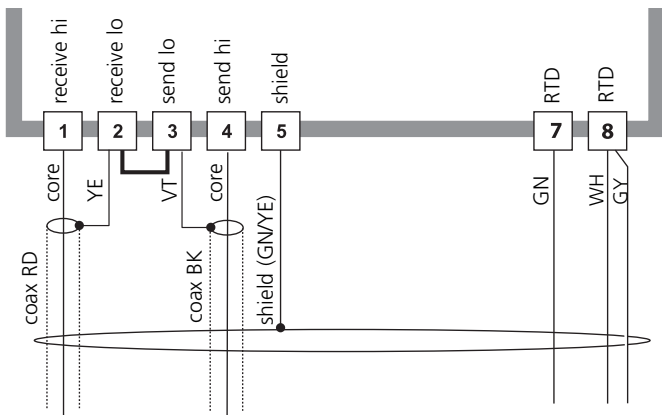

# User interface and display

## User interface

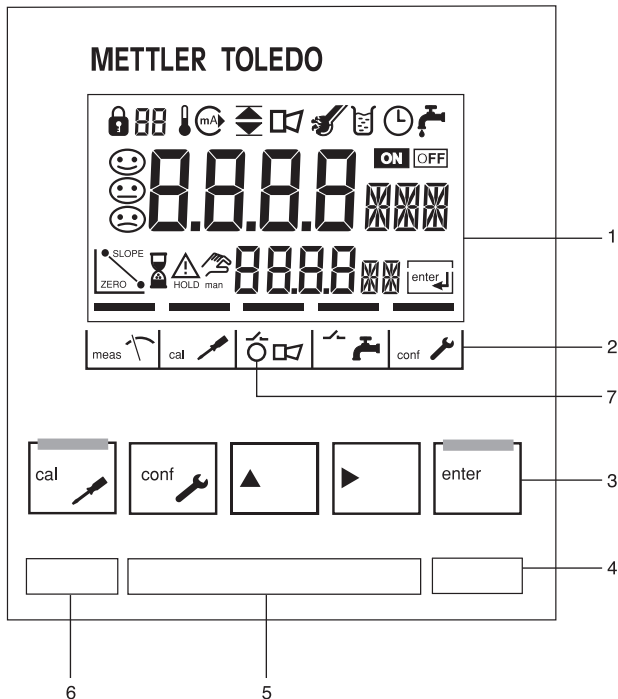

- |   |  |   |                   |
|---|--|---|-------------------|
| 1 | Display  | 3 | Keypad            |
| 2 | Mode indicators (no keys), from left to right: | 4 | Coding            |
|   | - Measuring mode                               | 5 | Rating plate      |
|   | - Calibration mode                             | 6 | Model designation |
|   | - Alarm  | 7 | Alarm LED         |
|   | - Wash contact (Cond Ind 7100e only)           |   |                   |
|   | - Configuration mode                           |   |                   |



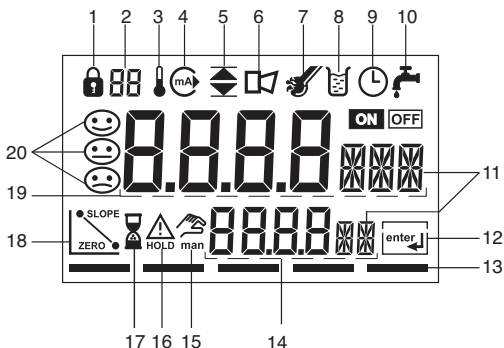







## Display



- |    |  |    |                           |
|----|--|----|---------------------------|
| 1  | Passcode entry   | 14 | Lower display             |
| 2  | Display of measured variable*  | 15 | Manual temp specification |
| 3  | Temperature  | 16 | Hold mode active          |
| 4  | Current output   | 17 | Waiting time running      |
| 5  | Limit values   | 18 | Sensor data               |
| 6  | Alarm  | 19 | Main display              |
| 7  | Sensocheck   | 20 | Sensoface                 |
| 8  | Calibration  |    |                           |
| 9  | Interval/response time   |    |                           |
| 10 | Wash contact*  |    |                           |
| 11 | Measurement symbols  |    |                           |
| 12 | Proceed with <b>enter</b>  |    |                           |
| 13 | Bar for identifying the device status, above mode indicators from left to right: |    |                           |
|    | - Measuring mode   |    |                           |
|    | - Calibration mode   |    |                           |
|    | - Alarm  |    |                           |
|    | - Wash contact*  |    |                           |
|    | - Configuration mode   |    |                           |

\* Not in use

## Operation: Keypad

	Start, end calibration
	Start, end configuration
	Select digit position (selected position flashes)
	Edit digit
	<ul style="list-style-type: none"><li>• Calibration: Continue in program sequence</li><li>• Configuration: Confirm entries, next configuration step</li><li>• Measuring mode: Display output current</li></ul>
 → 	Cal Info, display of cell factor and zero point
 → 	Error Info: Display of last error message
 + 	Start GainCheck device self-test

## Safety functions

### **Sensocheck, Sensoface sensor monitoring**



Sensocheck continuously monitors the sensor and lines. The primary and its lines are monitored for short circuit and the secondary and its lines are monitored for open circuit. Sensocheck can be switched off (Configuration, Pg 55).



Sensoface provides information on the conductivity sensor condition.

### **GainCheck device self-test**

A display test is carried out, the software version is displayed and the memory and measured value transfer are checked.

Start GainCheck device self test:  + 

### **Automatic device self-test**

The automatic device self-test checks the memory and measured-value transfer. It runs automatically in the background at fixed intervals.

# Safety functions

## Hold mode

Display: 

The Hold mode is a safety state during configuration and calibration. The loop current is frozen (Last) or set to a fixed value (Fix).

If the calibration or configuration mode is exited, the transmitter remains in the Hold mode for safety reasons. This prevents undesirable reactions of the connected peripherals due to incorrect configuration or calibration. The measured value and "HOLD" are displayed alternately. The transmitter only returns to measuring mode after **enter** is pressed and 20 seconds have passed.

Configuration mode is also exited automatically 20 minutes after the last keystroke (timeout). The transmitter returns to measuring mode.

Timeout is not active during calibration.

Behavior of output signal:

Last: The loop current is frozen at its last value.  
Recommended for short configuration procedures.  
The process should not change decisively during configuration. Changes are not noticed with this setting!

Fix: The loop current is set to a value that is noticeably different from the process value in order to signal the control system that the transmitter is being worked at.  
See Configuration, Pg 51.

## Outputs

### Current output / Loop current

The loop current is controlled by the process variable selected in the configuration.

The current start and end can be set to represent any desired value. To check connected peripherals (e.g. limit switches, controllers), the loop current can be manually specified (see Pg. 41).

### HART communication

The Transmitter Cond Ind 7100e/2(X) can be remote-controlled via HART communication. It can be configured using a hand-held terminal or from the control room. Measured values, messages and device identification can be downloaded at any time. This allows easy integration also in fully automatic process cycles.

A list of the HART commands can be found in the "Transmitter Cond Ind 7100e/2(X) Transmitter-Specific Command Specification": [www.mtpro.com/transmitters](http://www.mtpro.com/transmitters).

### Alarm

The alarm delay is configurable.

Error messages can also be signaled by a 22 mA loop current (see Configuration, Pg 55).

The alarm LED on the front panel can be configured as follows:

HOLD off:	Alarm: LED flashing
HOLD on:	Alarm: LED on. HOLD: LED flashing.















# Passcodes (factory setting)

The passcodes allow fast access to the functions

## Calibration

Key+passcode	Description	Page
 0000	<b>Cal Info</b>	71
 1001	<b>Zero calibration</b>	66
 1100	<b>Calibration:</b> Entry of cell factor	60
 0110	<b>Calibration:</b> Calibration solution	62
 1105	<b>Product calibration</b>	64
 1015	<b>Temp probe adjustment</b>	70

## Configuration

Key+passcode	Description	Page
 0000	<b>Error Info</b> Display last error and erase	74
 1200	<b>Configuration</b>	34
 2222	<b>Sensor monitor</b> Display resistance and temp	71
 5555	<b>Current source</b> Specify output current	72

## Passcode editor

Key+passcode	Description	Page
 1989	<b>Administrator passcode</b> Changing the passcodes	56

# Configuration

In the Configuration mode you set the device parameters.

Activate



Activate with **conf**



Enter passcode "1200"\*.  
Edit parameter with **▶** and **▲**,  
confirm/continue with **enter**.  
(End with **conf**, then **enter**.)

Hold

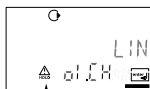

HOLD icon

During configuration the transmitter remains in the Hold mode for reasons of safety. The loop current is frozen (at its last value or at a preset fixed value, depending on the configuration), Sensoface is off, mode indicator "Configuration" is on.

Input errors



The configuration parameters are checked during the input. In the case of an incorrect input "Err" is displayed for approx. 3 sec. The incorrect parameters cannot be stored. Input must be repeated.

End



End with **conf**. The measured value and Hold are displayed alternately, "**enter**" flashes. Press **enter** to end the Hold mode. The measured value is displayed. The output current remains frozen for another 20 s (HOLD icon on, "hourglass" flashes).

\* Factory setting, for passcode editing, see Pg 56

## Menu structure of configuration

The configuration steps are assigned to different menu groups:

- Current output (code: o1.)
- Temperature compensation (code: tc.)
- Alarm settings (code: AL.)

With the arrow keys you can jump between the individual menu groups. Each menu group contains menu items for setting the parameters.



Example:  
 "o1." is displayed with all menu items of the  
 "Current output" menu group.

Pressing **enter** accesses the submenus. The values are edited using the arrow keys. Pressing **enter** confirms/stores the settings.

Return to measurement: Press **conf**. Press **enter** to confirm safety prompt. After 20 sec the transmitter will be in measuring mode again.

Select menu group	Menu group	Code	Display	Select menu item
	Current output	o1.		
	Menu item 1			
	Menu item 2			
	Menu item ...			
	Temperature compensation	tc.		
	Alarm settings	AL.		
				Previous menu group:

# Overview of configuration steps

Code	Menu	Selection / Default				
<b>out1</b>	<b>Current output</b>	<b>(Factory setting bold print)</b>				
o1.SnSR	Sensor selection Only with Other:	<b>7250 IPR</b> , Other				
o1.CELL	Entry of cell factor	<b>2.175</b> (00.100...20.000)				
o1.SFC	Enter transfer ratio	<b>120.00</b> (001.00...200.00)				
o1.rTD	Select temperature probe	Pt100/ <b>Pt1000</b> /NTC100/NTC30				
o1.UnIT	Select measured variable	<b>mS/cm</b> , S/m, SAL, %				
o1.CoNC	Select solution Codes: -01- to —10- see Pg 42	<table border="1"> <tr> <td><b>NaCl</b></td> <td>Codes -02- ... -10-</td> </tr> <tr> <td><b>-01-</b></td> <td></td> </tr> </table>	<b>NaCl</b>	Codes -02- ... -10-	<b>-01-</b>	
<b>NaCl</b>	Codes -02- ... -10-					
<b>-01-</b>						
o1.CHAR	Characteristic linear / logarithmic (not for SAL, Conc)	<b>LIN</b> / LOG				
o1.4mA	LIN: Enter current start	xxxx mS ( <b>000.0 mS</b> )				
o1.20mA	Enter current end	xxxx mS ( <b>000.0 mS</b> )				
o1.4mA	LOG: Enter current start	in decades: 0.001 ... 1000 mS ( <b>0.100 mS</b> )				
o1.20mA	Enter current end	in decades: 0.001 ... 1000 mS ( <b>100.0 mS</b> )				
o1.FtME	Time constant of output filter	xxxx SEC ( <b>0000 SEC</b> )				
o1.FAIL	22 mA signal for error messages	ON / <b>OFF</b>				
o1.HoLD	Signal behavior during HOLD	<b>Last</b> / Fix				
o1.FIX	Fix: Enter fixed value	xxx.x mA ( <b>021.0 mA</b> )				
<b>tc</b>	<b>Temperature compensation</b>					
tc.UnIT	Select temperature unit	°C / °F				
tc.	Select temperature compensation (not for SAL)	<b>OFF</b> /LIN/NLF (natural waters)				
tc.lin	Lin: Enter temperature coefficient	xx.xx %/K ( <b>02.00 %/K</b> )				
<b>ALrt</b>	<b>Alarm settings</b>					
AL.SnSO	Select Sensocheck	ON / <b>OFF</b>				
AL.dLY	Enter alarm delay	0000 ... 0600 SEC ( <b>0010 SEC</b> )				
AL.LED	LED in HOLD mode	ON / <b>OFF</b>				

# Individual settings

METTLER TOLEDO

(Original for copy)

<b>Code</b>	<b>Parameter</b>	<b>Default settings</b>	<b>Individual settings</b>
o1.SnSR	Sensor selection	<u>7250 IPR</u>	<u>                    </u>
	- With "Other" selected:		
	- Cell factor	<u>2.175</u>	<u>                    </u>
	- Transfer ratio	<u>120.00</u>	<u>                    </u>
	- Temperature probe	<u>Pt 1000</u>	<u>                    </u>
o1.UnIT	Measurement unit	<u>000.0 mS/cm</u>	<u>                    </u>
o1.CoNC	Concentration	<u>NaCl</u>	<u>                    </u>
o1.CHAR	Characteristic (LINLOG)	<u>LIN</u>	<u>                    </u>
o1.4mA	Current start	<u>000.0 mS</u>	<u>                    </u>
o1.20mA	Current end	<u>100.0 mS</u>	<u>                    </u>
o1.FtME	Filter time	<u>0000 SEC</u>	<u>                    </u>
o1.FAIL	22mA signal	<u>OFF</u>	<u>                    </u>
o1.HoLD	Hold behavior	<u>LAST</u>	<u>                    </u>
o1.FIX	Fix current	<u>021.0 mA</u>	<u>                    </u>
tc.UnIT	Unit °C / °F	<u>°C</u>	<u>                    </u>
tc.	Temp.compensation	<u>OFF</u>	<u>                    </u>
tc.LIN	TC process medium	<u>02.00 %/K</u>	<u>                    </u>
AL.SnSO	Sensocheck	<u>OFF</u>	<u>                    </u>
AL.dLY	Alarm delay	<u>0010 SEC</u>	<u>                    </u>
AL.LED	LED in Hold mode	<u>OFF</u>	<u>                    </u>

# Configuration



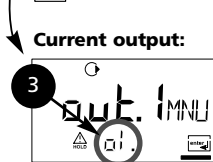
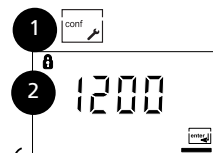

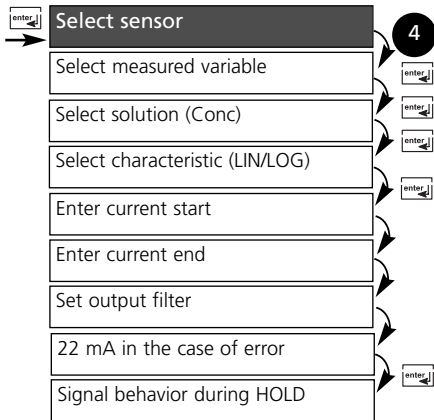
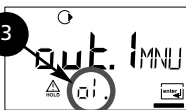

## Current output: Select sensor type.



1. Press **conf** key.
2. Enter passcode **1200**.
3. Select **Current output** menu group using arrow keys. All items of this menu group are indicated by the code "o1."
4. Press **enter** to select menu, edit with arrow keys (see Pg 39). Confirm (and proceed) with **enter**.
5. End: Press **conf**, then **enter**

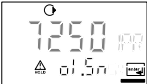

\* Factory setting, for passcode editing, see Pg 56

Code	Display	Action	Choices
<b>o1.</b>		Select configuration (Press <b>conf.</b> )	
	 <p>After correct input a welcome text (CONF) is displayed for approx. 3 sec.</p>	Enter passcode "1200"*. (Select position with ► arrow key and edit number with ▲ key. When the display reads "1200", press <b>enter</b> to confirm.)	
		The transmitter is in HOLD mode (HOLD icon is on).	
		Select sensor InPro 7250 / Other Select with ► arrow key Proceed with <b>enter</b>	<b>7250 IPR</b> (Other)
	   	When "Other" sensor has been selected:  Enter nominal cell factor (CELL). Select with ► arrow key Proceed with <b>enter</b>  Enter nom. transfer ratio (SFC). Select with ► arrow key Proceed with <b>enter</b>  Select temperature probe Select with ► arrow key Proceed with <b>enter</b>	<b>Pt1000</b> (Pt100, NTC30, NTC100)

**Note:** Characters represented in gray are flashing and can be edited.

\* Factory setting

# Configuration

**Current output: Select measured variable.**

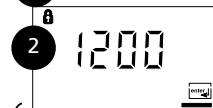
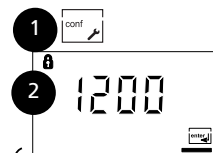

**Current output:**

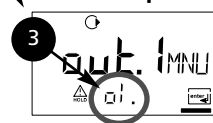

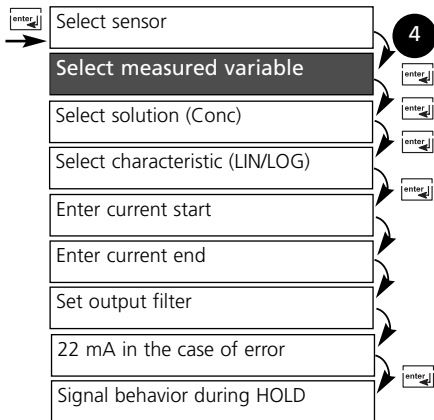

1. Press **conf** key.
2. Enter passcode **1200**.
3. Select **Current output** menu group using arrow keys.  
All items of this menu group are indicated by the code "o1."
4. Press **enter** to select menu, edit with arrow keys (see Pg 41).  
Confirm (and proceed) with **enter**.
5. End: Press **conf**, then **enter**



\* Factory setting

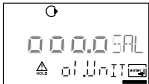
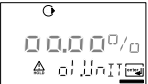

Code	Display	Action	Choices
<b>01.</b>	   	<p>Select measured variable:</p> <p>Select with ► arrow key Proceed with <b>enter</b></p> <p>Conductivity:</p> <ul style="list-style-type: none"> <li>• 0.000 ... 9.999 mS/cm</li> <li>• 00.00 ... 99.99 mS/cm</li> <li>• 000.0 ... 999.9 mS/cm</li> <li>• 0000 ... 1999 mS/cm</li> <li>• 0.000 ... 9.999 S/m</li> <li>• 00.00 ... 99.99 S/m</li> </ul> <p>Salinity (SAL):</p> <ul style="list-style-type: none"> <li>• 0.0 ... 45.0 ‰ (0 ... 35 °C)</li> </ul> <p>Concentration (Conc):</p> <ul style="list-style-type: none"> <li>• 0.00 ... 9.99 % by wt</li> <li>• 10.0 ... 100.0 % by wt</li> </ul>	<p><b>000.0 mS</b></p> <p>(0.000 mS 00.00 mS 000.0 mS</p> <p>0.000 S/m 00.00 S/m</p> <p>00.00 SAL 00.00 ‰)</p>

**Note:** Characters represented in gray are flashing and can be edited.

# Configuration

## Current output

**Concentration measurement: Select process solution.**

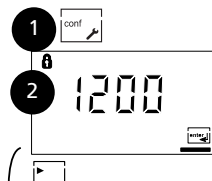

### Current output:

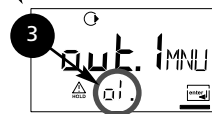

1. Press **conf** key.
2. Enter passcode **1200**\*
3. Select **Current output** menu group using arrow keys.  
All items of this menu group are indicated by the code "o1."
4. Press **enter** to select menu, edit with arrow keys (see Pg 43).  
Confirm (and proceed) with **enter**.
5. End: Press **conf**, then **enter**

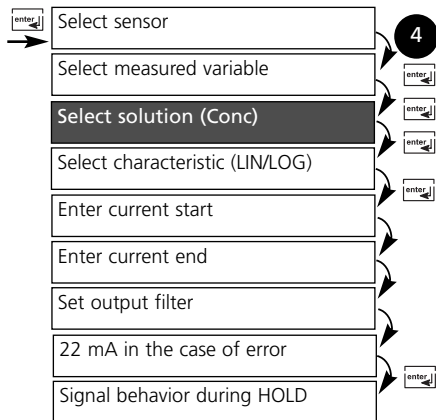

\* Factory setting

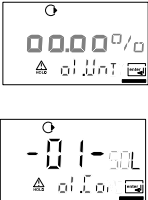
Code	Display	Action	Choices
<b>01.</b>		<p>Only with 00.00 % can you select the process solution:</p> <p>Select with ► arrow key</p> <p>NaCl*    <b>-01-</b></p> <p>HCl*     <b>-02-</b>           <b>-07-</b></p> <p>NaOH*   <b>-03-</b>           <b>-10-</b></p> <p>H<sub>2</sub>SO<sub>4</sub>* <b>-04-</b>           <b>-06-</b>           <b>-09-</b></p> <p>HNO<sub>3</sub>*   <b>-05-</b>           <b>-08-</b></p> <p>Proceed with <b>enter</b></p> <p>*Ranges: see Pg 82 and the following</p>	<p><b>-01-SOL</b> (-01-SOL -02-SOL -03-SOL -04-SOL -05-SOL -06-SOL -07-SOL -08-SOL -09-SOL -10-SOL)</p>

## Concentration measurement

For the solutions listed above, the transmitter can determine the substance concentration from the measured conductivity and temperature values in % by wt. The measurement error is made up of the sum of measurements errors during conductivity and temperature measurement and the accuracy of the concentration curves stored in the transmitter (see Pg 88 et seq.). We recommend to calibrate the transmitter together with the sensor, preferably in the same conductivity range as measured later. For exact temperature measurement, you should perform a temperature probe adjustment. For measuring processes with rapid temperature changes, a separate temperature probe with fast response should be used.

# Configuration

## Output current. LIN characteristic. Current start/end

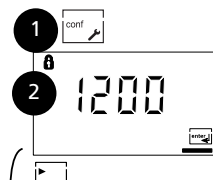

### Current output:

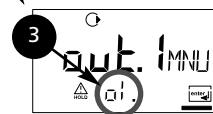

1. Press **conf** key.
2. Enter passcode **1200**.
3. Select **Current output** menu group using arrow keys.  
All items of this menu group are indicated by the code "o1."
4. Press **enter** to select menu, edit with arrow keys (see Pg 45). Confirm (and proceed) with **enter**.
5. End: Press **conf**, then **enter**

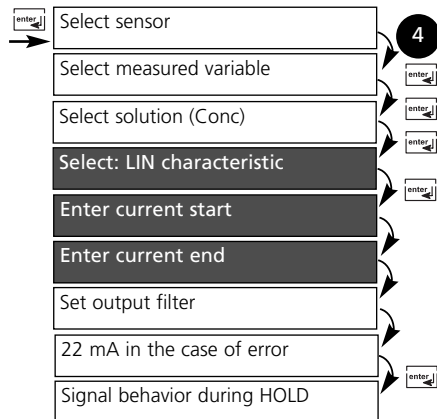

\* Factory setting

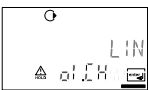
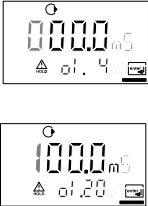
Code	Display	Action	Choices
<b>o1.</b>		Select output characteristic Select with ► arrow key Proceed with <b>enter</b> (Step omitted for % (Conc) or SAL)	<b>LIN</b> (LIN / LOG)
		With LIN selected: • Enter current start (lower end of scale). Select with ► key, edit number with ▲ key, proceed with <b>enter</b> . • Enter current end (upper end of scale). Proceed with <b>enter</b>	<b>000.0 mS</b> (xxx.x mS)  <b>100.0 mS</b> (xxx.x mS)

### Assignment of measured values: Current start and current end

Example 1: Range 0...200 mS/cm

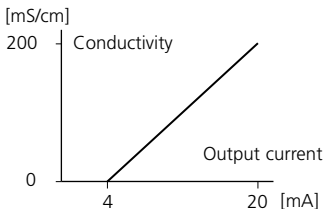

Example 2: Range 100...200 mS/cm  
Advantage: Higher resolution in range of interest

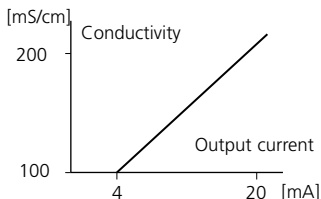

# Configuration

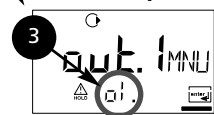
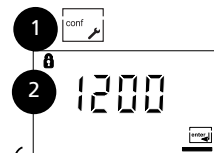

## Output current. LOG characteristic. Current start / end

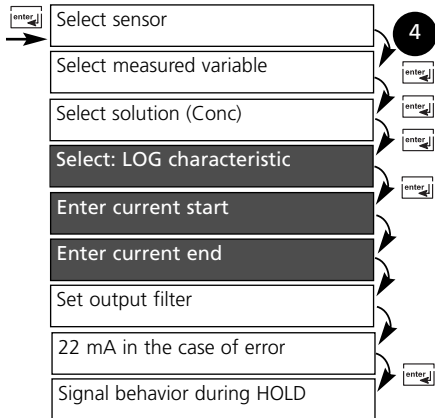

1. Press **conf** key.
2. Enter passcode **1200**.
3. Select **Current output** menu group using arrow keys.  
All items of this menu group are indicated by the code "o1."
4. Press **enter** to select menu, edit with arrow keys (see Pg 47). Confirm (and proceed) with **enter**.
5. End: Press **conf**, then **enter**



\* Factory setting

Code	Display	Action	Choices
<b>01.</b>		With <b>LOG</b> selected not with % (Conc) or SAL): <ul style="list-style-type: none"> <li>Enter lower end of scale (=current start)</li> </ul> Select with <b>▶</b> key, edit number with <b>▲</b> key, proceed with <b>enter</b> .	<b>0.1 mS</b> (0.001 mS 0.01 mS 0.1 mS 1.0 mS 10 mS 100 mS 1000 mS)
		<ul style="list-style-type: none"> <li>Enter upper end of scale (=current end)</li> </ul> Select with <b>▶</b> key, edit number with <b>▲</b> key.  Proceed with <b>enter</b>	<b>100 mS</b> (0.001 mS 0.01 mS 0.1 mS 1.0 mS 10 mS 100 mS 1000 mS)

### Example: Measurement range over 3 decades

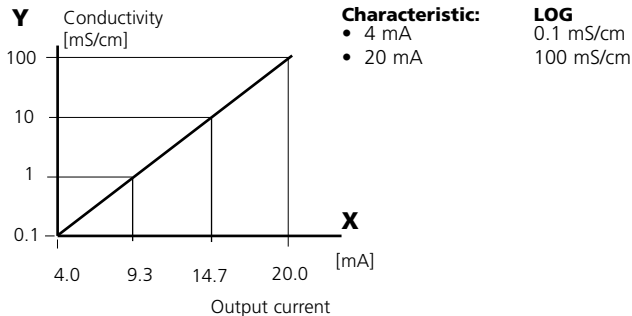

# Configuration

## Output. Time constant of output filter

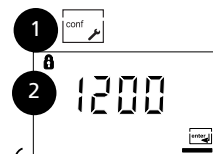

### Current output:

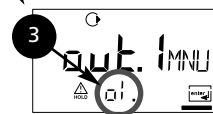

1. Press **conf** key.
2. Enter passcode **1200**.
3. Select **Current output** menu group using arrow keys.  
All items of this menu group are indicated by the code "o1."
4. Press **enter** to select menu, edit with arrow keys (see Pg 49). Confirm (and proceed) with **enter**.
5. End: Press **conf**, then **enter**

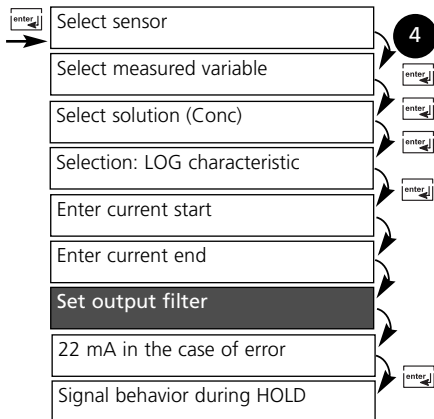

\* Factory setting



Code	Display	Action	Choices
<b>o1.</b>		Time constant of output filter Default setting: 0 s (inactive). To specify a time constant: Select with <b>▶</b> key, edit number with <b>▲</b> key, proceed with <b>enter</b>	<b>0 sec</b> 0 ... 120 sec

### Time constant of output filter (attenuation)

To smoothen the current output, a low-pass filter with adjustable filter time constant can be switched on. When there is a jump at the input (100 %), the output level is at 63 % after the time constant has been reached.

The time constant can be set from 0 to 120 sec.

If the time constant is set to 0 s, the current output follows the input.

#### Note:

The filter only acts on the current output, not on the display!

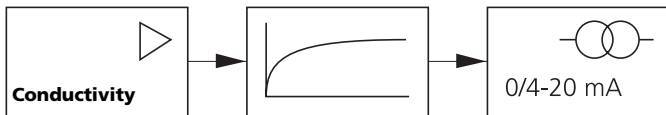

Time constant 0 to 120 sec

# Configuration

## Output. Output current during Error and HOLD.

1. Press **conf** key.

2. Enter passcode **1200**.

3. Select **Current output** menu group using arrow keys.  
All items of this menu group are indicated by the code "o1."

4. Press **enter** to select menu, edit with arrow keys (see Pg 51). Confirm (and proceed) with **enter**.

5. End: Press **conf**, then **enter**

4

5

conf

enter

\* Factory setting

Code	Display	Action	Choices
<b>01.</b>		22 mA signal for error message Select with <b>▶</b> arrow key Proceed with <b>enter</b>	<b>OFF</b> (OFF / ON)
		Output signal for HOLD <b>LAST:</b> During HOLD the last measured value is maintained at the output <b>FIX:</b> During HOLD a value (to be entered) is maintained at the output Select with <b>▶</b> arrow key Proceed with <b>enter</b>	<b>LAST</b> (LAST / FIX)
	 	Only with FIX selected: Enter current which is to flow at the output during HOLD Select position with <b>▶</b> arrow key and edit number with <b>▲</b> key. Proceed with <b>enter</b>	<b>021.0 mA</b> (04.0 ... 22.0 mA)

### Output signal during HOLD:

(see Pg 30)

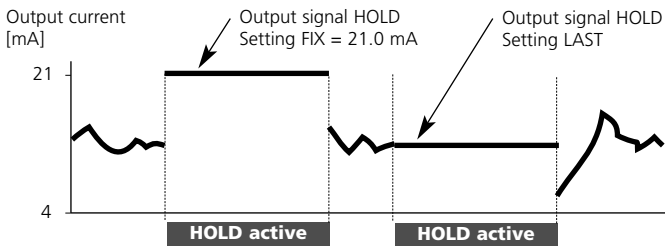

# Configuration

## Temperature compensation

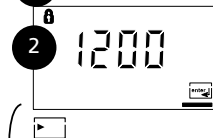
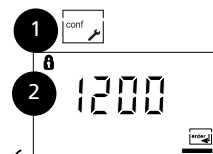

### Current output:

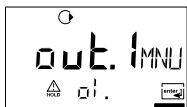



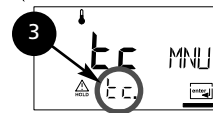

### Temp compensation:

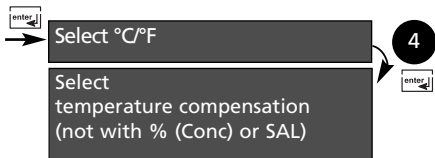

1. Press **conf** key.
2. Enter passcode **1200**\*
3. Select **Temperature compensation** menu group using arrow keys. All items of this menu group are indicated by the code "tc."
4. Edit with arrow keys (see Pg 53). Confirm (and proceed) with **enter**.
5. End: Press **conf**, then **enter**

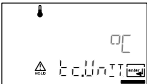

\* Factory setting



Code	Display	Action	Choices
<b>tc.</b>		Specify temperature unit Select with <b>▶</b> arrow key Proceed with <b>enter</b>	<b>°C</b> (°F)
		Temp compensation selection (not with Conc, Sal) <b>OFF:</b> Temperature compensation switched off. Select with <b>▶</b> key, proceed with <b>enter</b> <b>LIN:</b> Linear temperature compensation with entry of temp coefficient and reference temperature. <b>nLF:</b> Temperature compensation for natural waters to EN 27888	<b>OFF</b> (OFF LIN nLF)
			
			
	Only with linear temperature compensation ( <b>LIN</b> ) selected: Enter temperature coefficient*. Select position with <b>▶</b> arrow key and edit number with <b>▲</b> key. Proceed with <b>enter</b>	<b>02.00%/K</b> (XX.XX %/K)	

\* Reference temp 25 °C

# Configuration

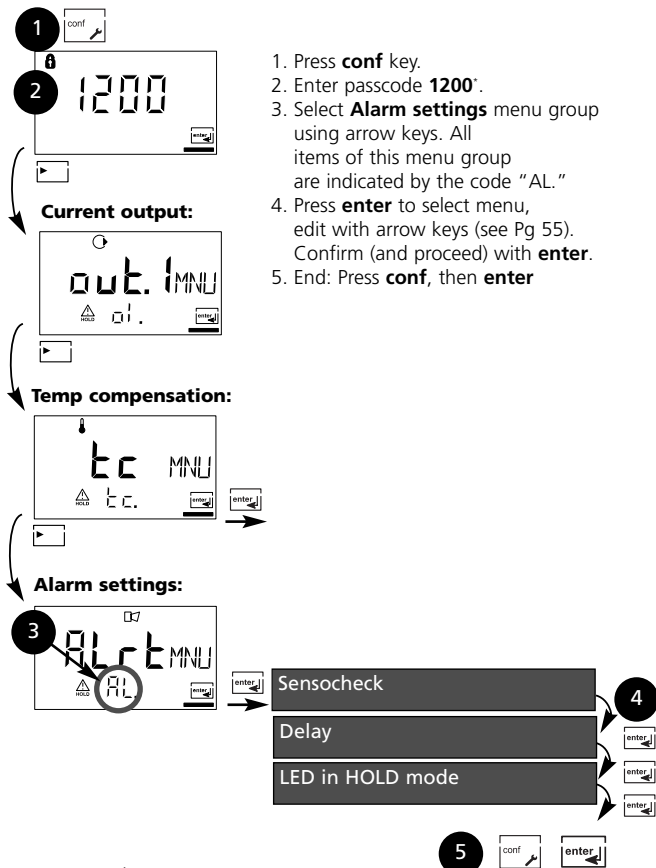
## Alarm settings







Code	Display	Action	Choices								
<b>AL.</b>		Select Sensocheck (Continuous monitoring of sensor properties) Select with ▶ key. Proceed with <b>enter</b>	<b>OFF</b> (ON / OFF)								
		Alarm delay Select with ▶ key, edit number with ▲ key, proceed with <b>enter</b>	<b>0010 s</b> (xxxx s)								
		LED in HOLD mode Select with ▶ key, proceed with <b>enter</b>  LED in HOLD mode: <table border="1" data-bbox="397 793 806 911"> <thead> <tr> <th>Configuration</th> <th>Alarm</th> <th>HOLD</th> </tr> </thead> <tbody> <tr> <td>ON</td> <td>on</td> <td>flashes</td> </tr> <tr> <td>OFF</td> <td>flashes</td> <td>off</td> </tr> </tbody> </table>	Configuration	Alarm	HOLD	ON	on	flashes	OFF	flashes	off
Configuration	Alarm	HOLD									
ON	on	flashes									
OFF	flashes	off									

# Passcodes according to FDA 21 CFR Part 11





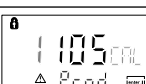
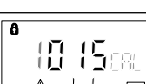

Access to the device functions can be protected with adjustable passcodes.

## To call up the passcode editor:

Press **conf** key and enter Administrator passcode  
(Factory setting: **1989**).

Display	Action	Remark
	1. Press <b>conf</b> key. 2. Enter Administrator passcode ( <b>1989</b> ): Welcome text is displayed	This text is displayed for approx. 3 sec
	<b>"Cal Info"</b> Edit: Arrow keys Proceed with: <b>enter</b> Cancel: <b>conf</b>	Default setting: <b>0000</b>
	<b>"Zero adjustment"</b> Edit: Arrow keys Proceed with: <b>enter</b> Cancel: <b>conf</b>	Default setting: <b>1001</b>
	<b>"Cell factor adjustment"</b> Edit: Arrow keys Proceed with: <b>enter</b> Cancel: <b>conf</b>	Default setting: <b>1100</b>
	<b>"Adjustment with entry of cal solution"</b> Edit: Arrow keys. Proceed with: <b>enter</b> . Cancel: <b>conf</b>	Default setting: <b>0110</b>
	<b>"Product calibration"</b> Edit: Arrow keys Proceed with: <b>enter</b> Cancel: <b>conf</b>	Default setting: <b>1105</b>
	<b>"Temp probe adjustment"</b> Edit: Arrow keys Proceed with: <b>enter</b> Cancel: <b>conf</b>	Default setting: <b>1015</b>



Display	Action	Remark
	<p><b>"Error Info"</b>                      Edit: Arrow keys                      Proceed with: <b>enter</b>                      Cancel: <b>conf</b></p>	Default setting: <b>0000</b>
	<p><b>"Configuration"</b>                      Edit: Arrow keys                      Proceed with: <b>enter</b>                      Cancel: <b>conf</b></p>	Default setting: <b>1200</b>
	<p><b>"Sensor monitor"</b>                      Edit: Arrow keys                      Proceed with: <b>enter</b>                      Cancel: <b>conf</b></p>	Default setting: <b>2222</b>
	<p><b>"Current source"</b>                      Edit: Arrow keys                      Proceed with: <b>enter</b>                      Cancel: <b>conf</b></p>	Default setting: <b>5555</b>
	<p><b>"Administrator passcode"</b>                      Edit: Arrow keys                      Proceed with: <b>enter</b>                      Cancel: <b>conf</b></p> <p><b>New "Administrator passcode"</b>                      Select <b>"NO" / "YES"</b>                      with arrow keys</p>	Default setting: <b>1989</b>
	<p><b>"NO"</b> <b>enter</b> = old passcode                      Cancel:  <b>conf</b> = old passcode</p>	<p><b>Caution!</b>                      If you have lost the Administrator passcode, the Passcode Editor cannot be called up! Please consult our technical support!</p>
	<p><b>"YES"</b> <b>enter</b> = take over                      new passcode                      Cancel:  <b>conf</b> = old passcode</p>	

# Calibration

Calibration adjusts the device to the sensor.

Activate



Activate with **cal**



Enter passcode\*:

- Entry of cell factor 1100
- With calibration solution 0110
- Product calibration 1105
- Zero point 1001
- Temp probe adjustment 1015

Select with **▶** key, edit number with **▲** key, proceed with **enter** key  
(End with **cal**, then **enter**.)

Hold



During calibration the transmitter remains in the Hold mode.



HOLD icon

The loop current is frozen (at its last value or at a preset fixed value, depending on the configuration), Sensoface is off, mode indicator "Calibration" is on.

Input errors

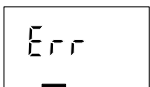

The calibration parameters are checked during the input. In the case of an incorrect input "Err" is displayed for approx. 3 sec. The incorrect parameters cannot be stored. Input must be repeated.

End



End with **cal**.

## Safety prompt:

The measured value and Hold are displayed alternately, "enter" flashes. Press **enter** to end the Hold mode. The measured value is displayed. The output current remains frozen for another 20 sec (HOLD icon on, "hourglass" flashes).

\* Factory setting, for passcode editing, see Pg 56

## Information on calibration

Calibration can be performed by:

- Entry of cell factor
- Determining the cell factor with a known calibration solution taking account of the temperature
- Product calibration
- Zero calibration in air or with calibration solution
- Temperature probe adjustment

### Note:

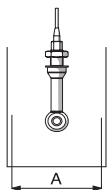





If measurements are taken in containers with  $A < 110$  mm, be sure to choose a container with the same cross-section and the same material (metal/plastic) for calibration.

### Caution

- All calibration procedures must be performed by trained personnel. Incorrectly set parameters may go unnoticed, but change the measuring properties.
- When another sensor is used, its sensor data (cell factor, transfer ratio, measuring frequency, temperature probe) must be entered in the configuration menu before calibration.
- Each time a new sensor is connected, the transmitter must be calibrated.

# Calibration by input of cell factor

Input of cell factor with simultaneous display of conductivity and temperature (without temperature compensation)



Display	Action	Remark
	Press <b>cal</b> key, enter code 1100* Select with <b>▶</b> key, edit number with <b>▲</b> key, proceed with <b>enter</b>	If an invalid code is entered, the transmitter returns to measuring mode.
	Ready for calibration  Dismount and clean sensor	Display (3 sec) Transmitter in Hold mode, measured value frozen. Sensoface inactive.
 	Enter cell factor: Select with <b>▶</b> key, edit number with <b>▲</b> key. Conductivity and temperature are alternately displayed during the input (lower display). Confirm entry with <b>enter</b> .	
	The entered cell factor and zero point are displayed. Confirm with <b>enter</b> .	

\* Factory setting



Display	Action	Remark
	<p>Conductivity and temperature are displayed.</p> <p>The measured value is shown in the main display alternately with "Hold"; "enter" flashes.</p> <p>Press <b>enter</b> to end calibration.</p>	<p>Safety prompt</p> <p>After end of calibration, the outputs remain in Hold mode for approx. 20 sec.</p>

# Calibration with calibration solution

Be sure to use known calibration solutions and the respective temperature-corrected conductivity values (see Calibration solutions Pg86). During the calibration procedure the temperature should be kept constant.

Display	Action	Remark
	Press <b>cal</b> key, enter code 0110* Select with <b>▶</b> key, edit number with <b>▲</b> key, proceed with <b>enter</b> .	If an invalid code is entered, the transmitter returns to measuring mode.
	Ready for calibration  Dismount and clean sensor	Display (3 sec) Transmitter in Hold mode, measured value frozen. Sensoface inactive.
	Immerse sensor in calibration solution. Enter the temperature-corrected conductivity value of the calibration solution: Select with <b>▶</b> key, edit number with <b>▲</b> key. Cell factor and temperature are alternately displayed in the lower display. Confirm entry with <b>enter</b> .	When there has not been an entry for 6 sec, the lower display alternately shows the conductivity and temperature value.

\* Factory setting

Display	Action	Remark
	<p>The determined cell factor and zero point are displayed. Confirm cell factor with <b>enter</b>.</p>	
	<p>Clean sensor and re-place it in the process. The transmitter now displays the conductivity and temperature.</p> <p>The measured value is shown in the main display alternately with "Hold"; "enter" flashes. Press <b>enter</b> to end calibration.</p>	<p>Safety prompt After end of calibration, the outputs remain in Hold mode for approx. 20 sec.</p>



# Product calibration

## Calibration by sampling

The measurement process is only interrupted briefly.  
During product calibration the sensor remains in the process.  
Calibration is without TC correction!





Procedure: During sampling the currently measured value is stored in the transmitter. The transmitter immediately returns to measuring mode. The calibration mode indicator flashes and reminds you that calibration has not been terminated. The sample is measured in the lab or directly on the site using a portable meter. The measured sample value is then entered in the transmitter. The new cell factor is calculated from these two values.

If the sample is invalid, you can take over the value stored during sampling. In that case the old calibration values are stored. Afterwards, you can start a new product calibration.

Display	Action	Remark
	<u>Product calibration step 1:</u> Press <b>cal</b> key. Enter passcode 1105*. (Press <b>▶</b> key to select position, enter number using <b>▲</b> key, confirm with <b>enter</b> )	If an invalid passcode is entered, transmitter returns to measuring mode.
		Display (approx. 3 sec)
	Take sample and store value. Proceed with <b>enter</b>	The sample is measured in the lab or directly on the site.



\* Factory setting



Display	Action	Remark
	<p>Measuring mode:</p> <p>From the flashing CAL mode indicator you see that product calibration has not been terminated.</p>	<p>While the sample value is determined, the transmitter returns to measuring mode.</p>
	<p><u>Product calibration step 2:</u> When the sample value has been determined, call up the product calibration once more (Press <b>cal</b> key. Enter passcode 1105*.</p>	<p>Display (approx. 3 sec)</p>
	<p>Enter lab value. The new cell factor is calculated.</p>	
	<p>The new cell factor and zero point are displayed. Confirm with <b>enter</b>.</p>	<p>New calibration: Press <b>cal</b>.</p>
	<p>The measured value is shown in the main display alternately with "Hold"; "enter" flashes. End with <b>enter</b>.</p>	<p>Safety prompt. After end of calibration, the outputs remain in Hold mode for approx. 20 sec.</p>

\* Factory setting

## Zero calibration in air

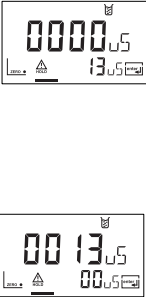



Display	Action	Remark
	<p>Press <b>cal</b> key, enter code 1001*</p> <p>Select with <b>▶</b> key, edit number with <b>▲</b> key, proceed with <b>enter</b></p>	<p>Transmitter is in Hold mode.</p> <p>If an invalid code is entered, the transmitter returns to measuring mode.</p>
	<p>Ready for calibration</p> <p>Dismount and clean sensor. (Sensor must be dry!)</p>	<p>Display (3 sec)</p>
	<p>Modify the zero point until zero is displayed as conductivity value in the lower display.</p> <p>Select with <b>▶</b> key, edit number with <b>▲</b> key.</p> <p>If required, change the sign of the zero point.</p> <p>Press <b>enter</b> to confirm the zero point.</p>	<p>When there has not been an entry for 6 sec, the lower display alternately shows the conductivity and temperature value.</p>

\* Factory setting

Display	Action	Remark
 <p>The screenshot shows a digital display with the number '0211' in large digits at the top. Below it, '001305' is displayed in smaller digits. Various icons are visible around the numbers, including a balance scale, a beaker, and a power symbol.</p>	<p>The cell factor and zero point are displayed. Press <b>enter</b> to confirm the calibration data.</p> <p>Place sensor in process.</p>	
	<p>The measured value is shown in the main display alternately with "Hold"; "enter" flashes. End calibration with <b>enter</b>.</p>	<p>Security prompt. After end of calibration, the outputs remain in Hold mode for approx. 20 sec.</p>

# Zero calibration with calibration solution



Calibration solution with low conductivity

Display	Action	Remark
	Press <b>cal</b> key, enter code 1001* Select with <b>▶</b> key, edit number with <b>▲</b> key, proceed with <b>enter</b> .	Transmitter is in Hold mode. If an invalid code is entered, the trans- mitter returns to measuring mode.
	Ready for calibration  Dismount and clean sensor	Display (3 sec)
	Immerse sensor in calibration solution. Modify the value until the lower display shows the conductivity value of the calibration solution. Press <b>enter</b> to confirm calibra- tion.	When there has not been an entry for 6 sec, the lower display alternately shows the conductiv- ity and temperature value.
	The cell factor and zero point are displayed.  Press <b>enter</b> to confirm the cali- bration data.	

\* Factory setting

Display	Action	Remark
	<p>Conductivity and temperature are displayed. Remove the sensor from the calibration solution and clean it. Place sensor in process.</p>	
	<p>The measured value is shown in the main display alternately with "Hold"; "enter" flashes. End calibration with <b>enter</b>.</p>	<p>Security prompt. After end of calibration, the outputs remain in Hold mode for approx. 20 sec.</p>





# Temperature probe adjustment

Display	Action	Remark
	Activate calibration (Press <b>cal</b> , Enter passcode 1015*.) Select with <b>▶</b> key, edit number with <b>▲</b> key, proceed with <b>enter</b> .	Wrong settings change the measure- ment properties! If an invalid passcode is entered, the trans- mitter returns to measuring mode.
	Ready for calibration	Transmitter is in Hold mode. Display for approx. 3 sec
	Measure the temperature of the process medium using an exter- nal thermometer. Enter measured temperature value: Select with <b>▶</b> key, edit number with <b>▲</b> key, proceed with <b>enter</b> . End adjustment with <b>enter</b> . HOLD will be deactivated after 20 sec.	Default: Current value of secondary display.

## Measurement

Display	Remark
	In the measuring mode the main display shows the configured process variable (conductivity, concentration, resistivity, or salinity) and the lower display the tempera- ture. During calibration you can return to measuring mode by pressing the <b>cal</b> key, during configuration by pressing <b>conf + enter</b> (waiting time for measured- value stabilization approx. 20 sec).

\* Factory setting

Entry/ Display	Remark
	<p><b>Display of the output current</b> Press <b>enter</b> while in measuring mode. For 5 sec, the secondary display shows the output current instead of the temperature.</p>
	<p><b>Display of calibration data (Cal Info)</b> Press <b>cal</b> while in measuring mode and enter passcode 0000*. The current cell factor is shown in the main display and the zero point underneath. After 20 sec the transmitter returns to measuring mode (immediate return at pressing <b>enter</b>).</p>
	<p><b>Sensor monitor for validation</b> of sensor and complete measured-value processing. Loop a defined sensing resistor (e.g. <math>R = 100 \Omega</math>) through the sensor as shown in the figure. Press the <b>conf</b> key and enter code 2222*. The sensor monitor displays the directly measured resistance and the temperature. If there is a significant difference between resistor value and display, the sensor and its transmission behavior should be checked. Press <b>enter</b> to return to measurement. <b>Note:</b> The transmitter does not automatically go to Hold mode.</p>
	<p><b>Display of last error message (Error Info)</b> Press <b>conf</b> while in measuring mode and enter passcode 0000*. The last error message is displayed for approx. 20 sec. After that the message will be deleted. (immediate return to measurement at pressing <b>enter</b>).</p>

\* Factory setting

# Diagnostics functions

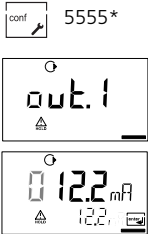





















Entry/ Display	Action / Remarks
 <p>The first screenshot shows the 'conf' menu with the passcode '5555*'. The second screenshot shows the 'out. 1' menu. The third screenshot shows the output current '12.2 mA'.</p>	<p><b>Specify output current</b> for testing the connected peripherals Press <b>conf</b> while in measuring mode and enter pass-code 5555*. The output current indicated in the main display can be modified. Select with <b>▶</b> key, edit number with <b>▲</b> key, proceed with <b>enter</b>. The actually measured current is shown in the secondary display. The transmitter is in Hold mode. Press <b>conf</b>, then <b>enter</b> to return to measurement (Hold remains active for another 20 sec).</p>

\* Factory setting

## Cleaning

To remove dust, dirt and spots, the external surfaces of the device may be wiped with a damp, lint-free cloth. A mild household cleaner may also be used if necessary.



Operating state	Out	LED	Time out
			
Measurement			
Cal Info (cal) 0000*			20 sec
Error Info (conf) 0000*			20 sec
Calibration (cal) 1100*			
Temp adjustment (cal) 1015*			
Product cal 1 step 1 (cal) 1105* step 2 (cal) 1105*	 	 	
Configuration (conf) 1200*			20 min
Sensor monitor (conf) 2222*			20 min
Current source (conf) 5555*			20 min

Explanation:

 active







 as configured (Last/Fix or Last/Off)

 LED flashes during HOLD (configurable)



\* Factory setting

## Error messages (Error Codes)

Error	Display	Problem Possible causes	Red LED	Out 1 (22 mA)
<b>ERR 01</b>	Measured value flashes	<b>Sensor</b> <ul style="list-style-type: none"> <li>• Measurement range violation</li> <li>• SAL &gt; 45 ‰</li> <li>• Sensor connection or cable defective</li> <li>• Wrong cell factor</li> </ul>	x	x
<b>ERR 02</b>	Measured value flashes	<b>Unsuitable sensor</b> Conductance range > 3000 mS	x	x
<b>ERR 98</b>	"Conf" flashes	<b>System error</b> Configuration or calibration data defective. Completely reconfigure and recalibrate the device. Memory error in device program	x	x
<b>ERR 99</b>	"FAIL" flashes	<b>Factory settings</b> EEPROM or RAM defective This error message only occurs in the case of a total defect. The transmitter must be repaired and recalibrated at the factory.	x	x
<b>ERR 03</b>		<b>Temperature probe</b> Open or short circuit Temperature range exceeded	x	x

Error	Icon (flashes)	Problem Possible causes	Red LED	Out 1 (22 mA)
<b>ERR 11</b>		<b>Current output</b> Current below 3.8 mA	x	x
<b>ERR 12</b>		<b>Current output</b> Current above 20.5 mA	x	x
<b>ERR 13</b>		<b>Current output</b> Current span too small / too large	x	x
<b>ERR 33</b>	 	<b>Sensocheck:</b> Primary coil	x	x
<b>ERR 34</b>		<b>Sensocheck:</b> Secondary coil		
	 	Temperature outside TC tables (TC, Conc, SAL)	independent of Sensoface	

## Display of last error message

Entry/ Display	Action / Remarks
 0000*  	<p><b>Display of last error message (Error Info)</b></p> <p>Press <b>conf</b> while in measuring mode and confirm code 0000*. The last error message is displayed for approx. 20 sec.</p> <p>After that the message will be deleted (immediate return to measurement at pressing <b>enter</b>).</p>

\* Factory setting

## Sensoface

(Sensocheck must have been activated during configuration.)

The smiley in the display (Sensoface) alerts to sensor problems (defective sensor, defective cable). The conditions for a friendly, neutral, or sad Sensoface are summarized in the following chart. Additional icons refer to the error cause.

### Sensocheck

Continuously monitors the primary coil and its lines for short circuits and the secondary coil and its lines for open circuits. Critical values make the Sensoface “sad” and the corresponding icon flashes:







The Sensocheck message is also output as error message Err 33 or Err 34. The red LED is lighted, the output current is set to 22 mA (when configured correspondingly). Sensocheck can be switched off during configuration (then Sensoface is also disabled). Exception: After a calibration a Smiley is always displayed for confirmation.

### Note:

The worsening of a Sensoface criterion leads to the devaluation of the Sensoface indicator (Smiley becomes “sad”).

To reset the Sensoface indicator, the defect must be remedied and the transmitter be calibrated.

Display	Problem	Status
	Sensor defect	 Short circuit in primary coil Open circuit in secondary coil (see also Error messages Err 33 and Err 34, Pg 75).
	Temperature error	 Temperature outside range for TC, conc, SAL (independent of Sensoface)



## Product line and accessories

### Devices

### Order no.

Transmitter Cond Ind 7100e/2H

52 121 257

Transmitter Cond Ind 7100e/2XH

52 121 258

### Mounting accessories

Pipe-mount kit

52 120 741

Panel-mount kit

52 120 740

Protective hood

52 120 739

### Sensors

Mettler-Toledo GmbH, Process Analytics offers a wide range of electrodeless sensors for the following fields of applications:

- Chemical process industry
- Pharmaceutical industry
- Food and beverage industry
- Pulp and paper industry
- Water/waste-water treatment

For more information concerning our sensors and housings program, please refer to our website:

<http://www.mtpro.com>

# Specifications

## Conductivity input

Input for electrodeless conductivity sensors

Effective range	Conductivity	0.000 mS/cm ... 1999 mS/cm
	Concentration	0.00 ... 100.0 % by wt
	Salinity	0.0 ... 45 ‰ (0 ... 35 °C)
Ranges *	Conductivity	0.000 ... 9.999 mS/cm 00.00 ... 99.99 mS/cm 000.0 ... 999.9 mS/cm 0000 ... 1999 mS/cm 0.000 ... 9.999 S/m 00.00 ... 99.99 S/m
	Concentration	0.00...9.99 / 10.0...100.0 % by wt
	Salinity	0.0 ... 45 ‰ (0 ... 35 °C)
Measurement error <sup>1,2,3</sup>		< 1% meas.val. + 0.02 mS/cm

## Concentration determination

### Operating modes: ')

NaCl**	-01-
HCl**	-02-
	-07-
NaOH**	-03-
	-10-
H <sub>2</sub> SO <sub>4</sub> **	-04-
	-06-
	-09-
HNO <sub>3</sub> **	-05-
	-08-

\*\*Ranges: see Pg 82 and the following

See graphs in the Appendix Pg 88 et seq.



**Sensor standardization**

Operating modes

- Entry of cell factor with simultaneous display of conductivity and temperature
- Input of conductivity of calibration solution with simultaneous display of cell factor and temperature
- Product calibration
- Zero point adjustment
- Temperature probe adjustment

Adm. cell factor

00.100 ... 19.999

Adm. transfer ratio

001.00 ... 199.99

Adm. zero point deviation

±0.5 mS/cm

**Sensor monitoring**

Monitoring of primary coil and its lines  
Sensocheck for short circuit and of secondary and its lines for open circuit

**Sensoface**

Provides information on the sensor condition (zero point, Sensocheck)

**Sensor monitor**

Direct display of measured values from sensor for validation (resistance / temperature)

**Temperature input \*)**

Pt100 / Pt1000 / NTC 30 kΩ / NTC 100 kΩ  
2-wire connection, adjustable

Ranges

Pt100/Pt1000     -20 .. +200 °C  
                          (-4 ... +392 °F)

NTC 30 kΩ        -20 ... +150 °C  
                          (-4 ... +302 °F)

NTC 100 kΩ     -20 ... +130 °C  
                          (-4 ... +266 °F)

Resolution

0.1 °C / 1 °F

Measurement error <sup>1,2,3)</sup>

0.5 K (<1 K for Pt100; <1 K for NTC >100 °C)

**Temperature compensation \***

(Reference temp 25 °C)

**(OFF)** none

**(Lin)** Linear characteristic 00.00 ... 19.99 %/K

**(NLF)** Natural waters to EN 27888

# Specifications

## Loop current

Supply voltage

Measured variable \*

Curve

Overrange \*

Output filter \*

Measurement error <sup>1)</sup>

Start/end of scale

Min. span

Current source function

4 ... 20 mA floating

14 ... 30 V

Conductivity, concentration, or salinity

Linear or logarithmic

22 mA in the case of error messages

Low-pass, filter time constant 0 ... 120 sec

< 0.3 % current value + 0.05 mA

As desired within range

LIN: 5 % of selected range

LOG: 1 decade

3.8 mA ... 22 mA

## HART communication

Digital communication by FSK modulation of loop current, reading of device identification, measured values, status, and messages, reading and writing of parameters, start of product calibration, signaling of configuration changes according to FDA 21 CFR Part 11

## Display

Main display

Secondary display

Sensoface

LC display, 7-segment with icons

Character height 17 mm, unit symbols 10 mm

Character height 10 mm, unit symbols 7 mm

3 status indicators

(friendly, neutral, sad Smiley)

Mode indicators

4 mode indicators

"meas", "cal", "alarm", "config"

Alarm indication

18 further icons for configuration and messages

Red LED in case of alarm or HOLD, user defined

## Keypad

5 keys: [cal] [conf] [▶] [▲] [enter]

---

\* User-defined

1) To IEC 746 Part 1, at nominal operating conditions

2) ± 1 count

3) Plus sensor error

## Service functions

Current source	Loop current specifiable 3.8 ... 22.00 mA
Device self-test	Automatic memory test (RAM, FLASH, EEPROM)
Display test	Display of all segments
Last Error	Display of last error occurred
Sensor monitor	Display of direct, uncorrected sensor signal (resistance/temperature)
Passcodes	Modifiable according to FDA 21 CFR Part 11 "Electronic Signatures"

## Data retention

Parameters and calibration data > 10 years (EEPROM)

## EMC

EN 61326	
Emitted interference:	Class B (residential area) Class A
Immunity to interference:	Industry

## Explosion protection

Cond Ind 7100e/2XH:	ATEX:	TÜV 99 ATEX 1434 II 2 (1) G EEx ib [ia] IIC T6
	FM:	FMRC J.I. 300580 IS/I/1/ABCD/T4 NI/II/2/ABCD/T4
	CSA:	1662790 C I I, Div 1, Gr ABC & D T4; Ex ib [ia] IIC T4 C I I, Div 2, Gr ABC & D, T4; Ex nAL[L] IIC T4
Cond Ind 7100e/2H:	FM:	FM 300580 NI/II/2/ABCD/T4

## Nominal operating conditions

Ambient temperature	-20 ... +55 °C
Transport/Storage temp	-20 ... +70 °C
Supply voltage	14... 30 V

# Specifications

<b>Enclosure</b>	Molded enclosure made of PBT (polybutylene terephthalate)
Color	Bluish gray RAL 7031
Mounting	<ul style="list-style-type: none"><li>• Wall mounting</li><li>• Pipe mounting:<ul style="list-style-type: none"><li>Ø 40 ... 60 mm, □ 30 to 45 mm</li></ul></li><li>• Panel mounting, cutout to DIN 43 700<ul style="list-style-type: none"><li>Sealed against panel</li></ul></li></ul>
Dimensions	H 144 mm, W 144 mm, D 105 mm
Protection	IP 65/NEMA 4X (USA, Canada: indoor use only)
Cable glands	3 breakthroughs for cable glands M20x1.5, 2 breakthroughs for NPT 1/2" or Rigid Metallic Conduit
Weight	Approx. 1 kg



# Calibration solutions

## Potassium chloride solutions

(Conductivity in mS/cm)

Temperature [°C]	Concentration *		
	0.01 mol/l	0.1 mol/l	1 mol/l
0	0.776	7.15	65.41
5	0.896	8.22	74.14
10	1.020	9.33	83.19
15	1.147	10.48	92.52
16	1.173	10.72	94.41
17	1.199	10.95	96.31
18	1.225	11.19	98.22
19	1.251	11.43	100.14
20	1.278	11.67	102.07
21	1.305	11.91	104.00
22	1.332	12.15	105.94
23	1.359	12.39	107.89
24	1.386	12.64	109.84
25	1.413	12.88	111.80
26	1.441	13.13	113.77
27	1.468	13.37	115.74
28	1.496	13.62	
29	1.524	13.87	
30	1.552	14.12	
31	1.581	14.37	
32	1.609	14.62	
33	1.638	14.88	
34	1.667	15.13	
35	1.696	15.39	
36		15.64	

1) Data source: K. H. Hellwege (Editor), H. Landolt, R. Börnstein: Zahlenwerte und Funktionen ..., volume 2, part. volume 6

**Sodium chloride solutions**

(Conductivity in mS/cm)

Temperature [°C]	Concentration		
	0.01 mol/l *	0.1 mol/l *	saturated **
0	0.631	5.786	134.5
1	0.651	5.965	138.6
2	0.671	6.145	142.7
3	0.692	6.327	146.9
4	0.712	6.510	151.2
5	0.733	6.695	155.5
6	0.754	6.881	159.9
7	0.775	7.068	164.3
8	0.796	7.257	168.8
9	0.818	7.447	173.4
10	0.839	7.638	177.9
11	0.861	7.831	182.6
12	0.883	8.025	187.2
13	0.905	8.221	191.9
14	0.927	8.418	196.7
15	0.950	8.617	201.5
16	0.972	8.816	206.3
17	0.995	9.018	211.2
18	1.018	9.221	216.1
19	1.041	9.425	221.0
20	1.064	9.631	226.0
21	1.087	9.838	231.0
22	1.111	10.047	236.1
23	1.135	10.258	241.1
24	1.159	10.469	246.2
25	1.183	10.683	251.3
26	1.207	10.898	256.5
27	1.232	11.114	261.6
28	1.256	11.332	266.9
29	1.281	11.552	272.1
30	1.306	11.773	277.4
31	1.331	11.995	282.7
32	1.357	12.220	288.0
33	1.382	12.445	293.3
34	1.408	12.673	298.7
35	1.434	12.902	304.1
36	1.460	13.132	309.5

1) Data source: Test solutions calculated according to DIN IEC 746-3

2) Data source: K. H. Hellwege (Editor), H. Landolt, R. Börnstein: Zahlenwerte und Funktionen ..., volume 2, part. volume 6

# Concentration measurement

## Measurement ranges

Substance	Concentration ranges		
NaCl	0-26 % by wt (0 °C) 0-28 % by wt (100 °C)		
Configuration	<b>-01-</b>		
HCl	0-18 % by wt (-20 °C) 0-18 % by wt (50 °C)	22-39 % by wt (-20 °C) 22-39 % by wt (50 °C)	
Configuration	<b>-02-</b>	<b>-07-</b>	
NaOH	0-13 % by wt (0 °C) 0-24 % by wt (100 °C)	15-50 % by wt (0 °C) 35-50 % by wt (100 °C)	
Configuration	<b>-03-</b>	<b>-10-</b>	
H <sub>2</sub> SO <sub>4</sub>	0-26 % by wt (-17 °C) 0-37 % by wt (110°C)	28-88 % by wt (-17 °C) 39-88 % by wt (115°C)	94-99 % by wt (-17 °C) 89-99 % by wt (115 °C)
Configuration	<b>-04-</b>	<b>-09-</b>	<b>-06-</b>
HNO <sub>3</sub>	0-30 % by wt (-20 °C) 0-30 % by wt (50 °C)	35-96 % by wt (-20 °C) 35-96 % by wt (50 °C)	
Configuration	<b>-05-</b>	<b>-08-</b>	

For the solutions listed above, the transmitter can determine the substance concentration from the measured conductivity and temperature values in % by wt. The measurement error is made up of the sum of measurements errors during conductivity and temperature measurement and the accuracy of the concentration curves stored in the transmitter.

We recommend to calibrate the transmitter together with the sensor. For exact temperature measurement, you should perform a temperature probe adjustment. For measuring processes with rapid temperature changes, a separate temperature probe with fast response should be used.



## Concentration curves

### -01- Sodium chloride solution NaCl

← -01- →

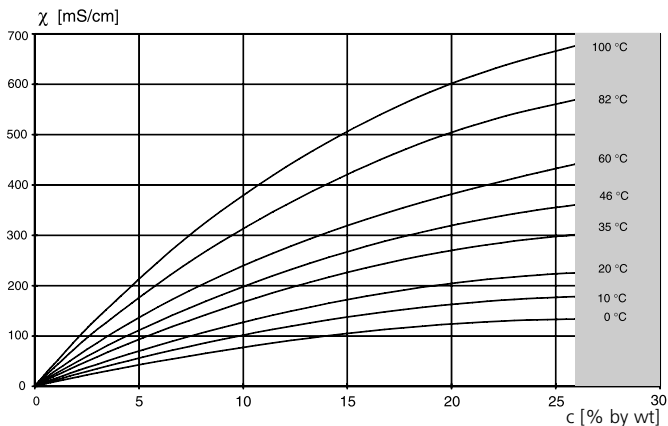

■ Concentration measurement not possible in this range.

Conductivity in dependence on substance concentration and process temperature for sodium chloride (NaCl)

**-02- Hydrochloric acid solution HCl**  
**-07-**

← **-02-** →      ← **-07-** →

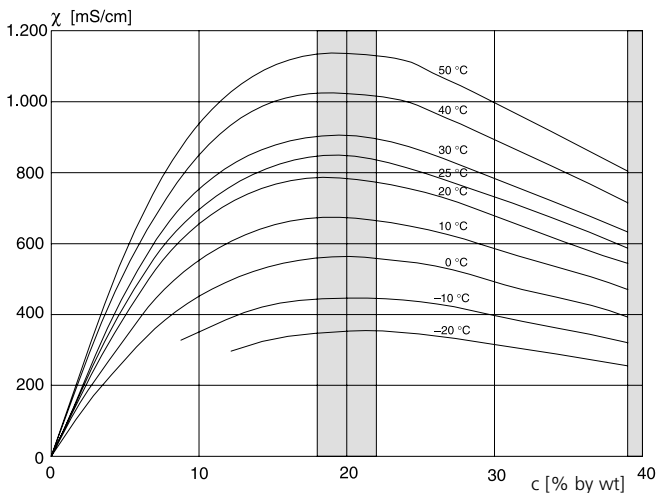

■ Concentration measurement not possible in this range.

Conductivity in dependence on substance concentration and process temperature for hydrochloric acid (HCl)

Source: Haase/Sauermann/Dücker; Z. phys. Chem. New Edition, Vol. 47 (1965)

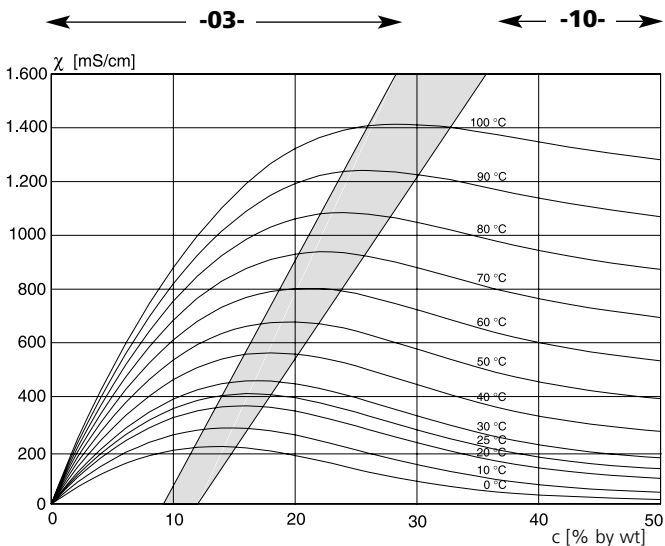
**-03- Sodium hydroxide solution NaOH****-10-**

■ Concentration measurement not possible in this range.

Conductivity in dependence on substance concentration and process temperature for sodium hydroxide solution (NaOH)

## -04- Sulphuric acid H<sub>2</sub>SO<sub>4</sub>

-06-

-09-

← -04- → ← -09- → → -06-

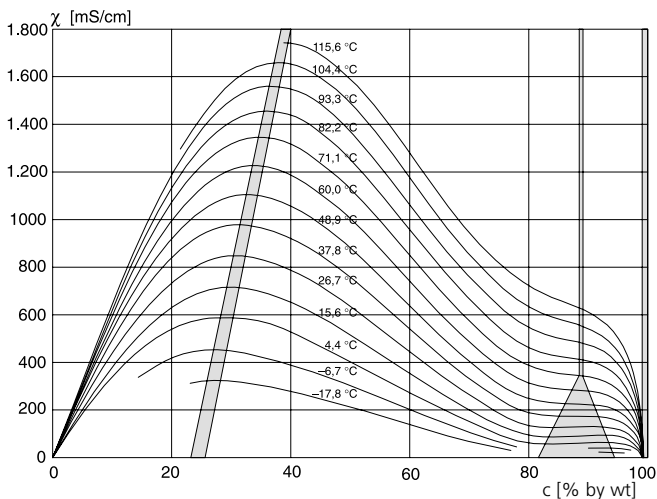

■ Concentration measurement not possible in this range.

Conductivity in dependence on substance concentration and process temperature for sulfuric acid (H<sub>2</sub>SO<sub>4</sub>),

Source: Darling; Journal of Chemical and Engineering Data;  
Vol. 9 No. 3, July 1964

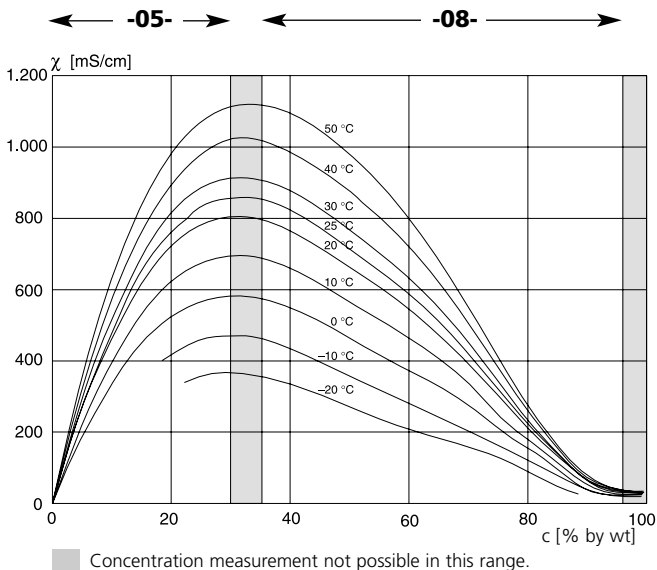
**-05- Nitric acid HNO<sub>3</sub>****-08-**

Conductivity in dependence on substance concentration and process temperature for nitric acid (HNO<sub>3</sub>)

Source: Haase/Sauermann/Dücker; Z. phys. Chem. New Edition, Vol. 46 (1965)

# FM Control Drawing

Copying of this document and giving it to others not use or communication for the contents therefore, are forbidden without express authority.

Metrische sowie Verdrungung dieser ubersicht, Verfertigung und Abholung eines Inhalts nicht gestattet, wenn nicht ausdrucklich zugeordnet.

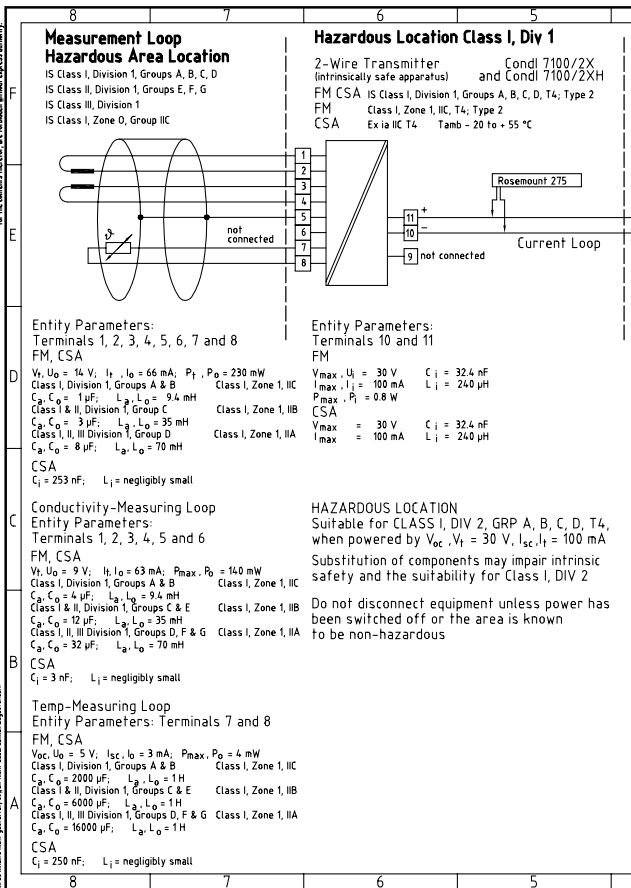

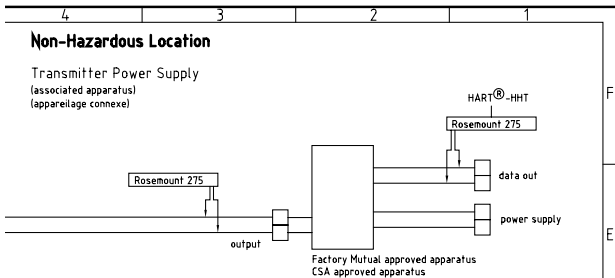

**NOTES :**

- $V_{max}, U_i > V_{oc}, V_t, \text{ or } U_o$        $I_{max}, I_j > I_{sc}, I_t, \text{ or } I_o$        $P_{max} > P_o$   
 $C_i + C_{cable} < C_A \text{ or } C_o$        $L_j + L_{cable} < L_A \text{ or } L_o$
- Installation must be in accordance with the National Electrical Code (ANSI/NFPA 70) and ANSI/ISA RP12.6 in US, Canadian Electric Code (Can3-M421) in Canada.
- Associated apparatus must be FMRC and CSA Approved and must be used in an FMR and CSA Approved configuration. Use of the Rosemount Model 275 Communicator in Zones is not an FMRC Approved configuration. The control drawing for the associated apparatus must be followed when installing this equipment.
- Control equipment connected to the associated apparatus must not use or generate more than 250 V.
- The intrinsically safe equipment connecting to 1, 2, 3, 4, 5, 6 and 7, 8 must be FMRC and CSA Approved or be simple apparatus (a device which will neither generate nor store more than 1.2 V, 0.1 A, 25 mW or 20 mJ).
- No revisions to drawing without prior FMRC and CSA Approval.
- Use of the Rosemount Model 275 Communicator is FM Approved for Division use only, see note 3. When using the Rosemount Model 275 Communicator in the loop between the associated apparatus and the Stratos 2211X Cond 2-Wire Transmitter, the maximum loop inductance must be less than the marked  $L_A$  of the associated apparatus to account for the  $I_{sc}$  from the Model 275 Communicator. Refer to the Rosemount Installation Drawing 00275-0081 to determine the allowable loop inductance.
- The Rosemount Model 275 Communicator is not approved by CSA for use in the entity concept. For CSA application the Rosemount Model 275 Communicator must only be used on the non-hazardous side of the barrier/transmitter power supply.

**Version METTLER TOLEDO**

Verteiler: FUL (2x)		Zul. Abweichungen für Maße ohne Toleranzangabe		Oberfläche		Maßstab		Page 1/2	
		ISO 2768 - m				Halbzeug			
		Datum		Name		Benennung			
		21.06.99		dam		control drawing FM			
		Beerb.		Gegr. (KON)		Cond Transmitter 7100/2X, 7100/2XH			
		Freigebe(FGL)		Schutzvermerk nach DIN 34 beachten		Zeichnungsnummer			
3 Page 2		05.01.05		dam		194.320-190			
2 product improvement CSA		11.07.00		dam					
1 product improvement		10.03.00		dam					
Nr. / AE		Datum		Bearbeiter/FGL. VN		Ungültig ab:		Ersetzt durch:	

# Explosion protection



## Certificate of Compliance

Certificate: 1662790

Master Contract: 220331

Project: 1662790

Date Issued: May 18, 2005

Issued to: Mettler-Toledo GmbH  
Im Hackacker 15  
Urdorf, 8902  
SWITZERLAND

Attention: Mr. Michael Haas

*The products listed below are eligible to bear the CSA Mark shown*



Issued by: K. Atkins

Authorized by:   
Nick Alfano  
Operations Manager

### PRODUCTS

CLASS 2258 04 - PROCESS CONTROL EQUIPMENT - Intrinsically Safe Entity - For Hazardous Locations

Class I, Division I, Groups A, B, C and D

Ex ib [ia] IIC

Transmitters Models 2100/2XH, 7100/2XH and Models 4100/2XH, input rated 30V, 4-20 mA, intrinsically safe devices provides intrinsically safe outputs to simple apparatus, pH, conductivity and oxygen probes when connected per control drawings 194.120-170, 194.220-190 and 194.320-190, 194.401-120. Maximum Ambient Temperature 55°C, Temperature Code T4.

For all models the input entity parameters are:

Terminals	Ui, Vmax	Ii, Imax	Pi, Pmax	Ci	Li
10, 11 or 14.15	30V	100mA	0.8W	32.4nF	0.24mH

Output entity parameters are:

2100/2XH



## Warnings and notes to ensure safe operation

**Warning:** Do not disconnect equipment unless power has been switched off.

**Warning:** Clean only with antistatic moistened cloth.

**Warning:** Substitution of components may impair suitability for hazardous locations.

- The equipment shall be installed and protected from mechanical impact and ultraviolet (UV) sources.
- Clean only with a moistened antistatic cloth as potential electrostatic hazard may exist. Service equipment only with conductive clothing, footwear and personal grounding devices to prevent electrostatic accumulation.
- Internal grounding provisions shall be provided for field wiring. Bonding between conduit shall be provided during installation, and all exposed non-current carrying metallic parts shall be bonded and grounded.
- Installation in a Class I, Division 2 or Class I, Zone 2 hazardous location shall be in accordance with the Canadian Electrical Code (CEC Part 1) Section 18 Division 2 wiring methods.

**OBSERVE THE SPECIFICATIONS OF THE CONTROL DRAWING!**

# CSA Control Drawing

Copping of this document and giving it to others and use or communication for the contents therefore, are forbidden without express authority.

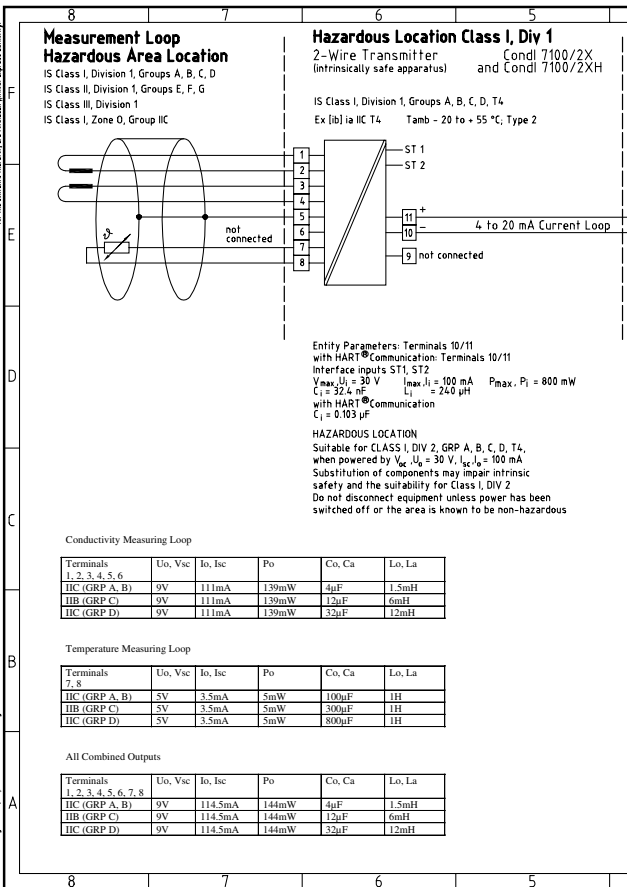

Wiedergabe sowie Vervielfältigung dieser Unterlagen, Verwertung und Mitteilung ihres Inhalts ist nicht gestattet, soweit nicht ausdrücklich angegeben.

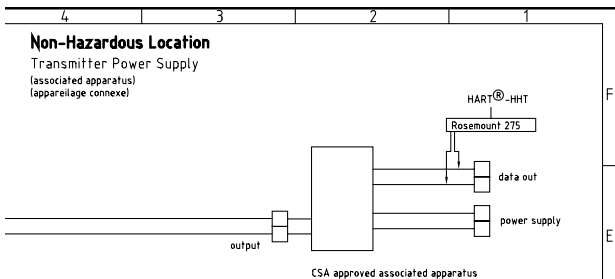

## Non-Hazardous Location

### Transmitter Power Supply

(associated apparatus)  
(appareillage connexe)

#### NOTES :

$$1: V_{max}, U_i > V_{oc}, U_o \quad I_{max}, I_i > I_{sc}, I_o \quad P_{max}, P_i > P_o$$

$$C_i + C_{cable} < C_A \text{ or } C_o \quad L_i + L_{cable} < L_A \text{ or } L_o$$

2: Installation must be in accordance with the Canadian Electric Code - Part 1

3: Associated apparatus must be CSA Approved and must be used in a CSA Approved configuration.

The control drawing for the associated apparatus must be followed when installing this equipment.

4: Control equipment connected to the associated apparatus must not use or generate more than 250 V.

5: The intrinsically safe equipment connecting to 1, 2, 3, 4, 5, 6 and 7, 8 must be CSA Approved or be simple apparatus (a device which will neither generate nor store more than 1.2 V, 0.1 A, 25 mW or 20 mJ).

6: No revisions to drawing without prior CSA Approval.

7: The Rosemount Model 275 Communicator must only be used on the non-hazardous side of the barrier/transmitter power supply

## Version METTLER TOLEDO

Verteiler: FUI (DZ)		Zul. Abweichungen für Maße ohne Toleranzangabe ISO 2768 - m		Oberfläche		Maßstab Halbzeug		Page 2/2		
			Datum	Name	Benennung					
			Bearb.	21.06.99	dam	control drawing CSA Cond Transmitter 7100/2X, 7100/2XH				
			Gepr. (KON)							
			Freigebe(FGL)			Zeichnungsnummer				
			Schutzvermerk nach DIN 34 beachten			194.320-190				
3	Page 2	05.01.05	dam							
2	product improvement CSA	11.07.00	dam							
1	product improvement	10.03.00	dam							
Nr. / AE	Datum	Bereiber	FGL KON	Ungültig ab:		Ersetzt durch:				



22 mA signal for error message . . . . . 51

**A**

Accessories . . . . . 79  
Alarm . . . . . 31  
Alarm settings . . . . . 54  
Attenuation . . . . . 49  
Audit Trail . . . . . 9

**C**

Calibration . . . . . 58  
    by input of cell factor . . . . . 60  
    by sampling . . . . . 64  
    Display of calibration data . . . . . 71  
    with calibration solution . . . . . 62  
    Zero calibration in air . . . . . 66  
    Zero calibration with calibration solution . . . . . 68  
Calibration solutions . . . . . 86  
Cleaning . . . . . 72  
Concentration measurement . . . . . 43  
    Concentration curves . . . . . 89  
    Ranges . . . . . 88  
Configuration . . . . . 34  
    Alarm settings . . . . . 54  
    Current start/end . . . . . 44  
    Factory setting . . . . . 36  
    Individual settings . . . . . 37  
    LIN characteristic . . . . . 44  
    LOG characteristic . . . . . 46  
    Measured variable . . . . . 40  
    Process solution . . . . . 42  
    Sensor type . . . . . 38  
    Time constant of output filter . . . . . 48

# Index

Configuration steps	36
Connection	20
Connection to supply units	6, 20
Contents	3
Control Drawing	94, 98
CSA Control Drawing	98
Current output	31
Configuration	38, 50
Display of output current	71
Current start/end	45

## D

Diagnostics functions	71, 72
Display	27
Disposal	2
Division 2 wiring	20

## E

EC Declaration of Conformity	8
EC-Type-Examination Certificate	10, 13
Electronic Signature	9
EMC	83
Error Info	75
Error messages	74
Display of last error message	71
Explosion protection	83
Certificate	96
Safety information	6

## F

FDA 21 CFR Part 11	9
FM Control Drawing	94

**H**

HART communication .....	31
Hold mode .....	30
LED in HOLD mode .....	55
Output signal for HOLD .....	51

**I**

Installation .....	20
Safety precautions .....	6
Intended use .....	7

**K**

Keypad .....	28
--------------	----

**L**

Loop current .....	31
--------------------	----

**M**

Measurement .....	70
Measurement range over 3 decades .....	47
Mounting plan .....	17

**O**

Operating states .....	73
Output current .....	31
Output current during Error and HOLD .....	50
Specify output current .....	72
Overview .....	15, 21

# Index

## P

Package contents	16
Panel-mount kit	19
Passcode editor	56
Passcodes (factory setting)	33
Pipe-mount kit	18
Product calibration	64
Product line and accessories	79
Protective hood	18

## R

Return of products	2
--------------------	---

## S

Safety functions	29
Automatic device self-test	29
GainCheck device self-test	29
Sensocheck, Sensoface sensor monitoring	29
Safety information	5, 6
Self test	29
Sensocheck	55, 76
Sensoface	76
Sensor monitor	71
Sensors	79
Wiring	24
Specifications	80

## T

Temperature compensation	52
Temperature probe adjustment	70
Time constant of output filter	49
Trademarks	7



**U**

User interface . . . . . 26

**W**

Warranty . . . . . 2

Wiring examples . . . . . 24





- BR**      **Mettler-Toledo Ind. e Com. Ltda.,**  
Alameda Araguaia, 451 - Alphaville  
BR - 06455-000 Barueri / SP, Brazil  
Phone +55 11 4166 74 00  
Fax +55 11 4166 74 01
- CH**      **Mettler-Toledo (Schweiz) AG,**  
Im Langacher,  
CH-8606 Greifensee, Switzerland  
Phone +41 44 944 45 45  
Fax +41 44 944 45 10
- D**        **Mettler-Toledo GmbH,** Prozeßanalytik,  
Ockerweg 3,  
D-35396 Gießen, Germany  
Phone +49 641 507-333  
Fax +49 641 507-397
- F**        **Mettler-Toledo Analyse Industrielle Sàrl,**  
30 Bld. de Douaumont, BP 949,  
F-75829 Paris Cedex 17, France  
Phone +33 1 47 37 06 00  
Fax +33 1 47 37 46 26
- USA**     **Mettler-Toledo Ingold, Inc.,**  
36 Middlesex Turnpike,  
USA - Bedford, MA 01730, USA  
Phone +1 781 301-88 00  
Fax +1 781 271-06 81



Subject to technical changes.  
© Mettler-Toledo GmbH, Process Analytics  
10/05 Printed in Switzerland. 52 120 967

Mettler-Toledo GmbH, Process Analytics  
Industrie Nord, CH-8902 Urdorf, Switzerland  
Phone + 41 44 736 22 11, Fax +41 44 736 26 36

[www.mtpro.com](http://www.mtpro.com)