

Operation Manual Multiparameter Transmitter M300



Transmitter Multiparameter M300
52 121 328

Operation Manual Multiparameter Transmitter M300

Index

1	Introduction	7
2	Safety instructions	7
2.1	Definition of equipment and documentation symbols and designations	7
2.2	Correct disposal of the unit	8
3	Unit overview	9
3.1	Overview 1/4DIN	9
3.2	Overview 1/2DIN	10
3.3	Control/Navigation Keys	11
3.3.1	Menu Structure	11
3.3.2	Navigation keys	11
3.3.2.1	Navigating the menu tree	11
3.3.2.2	Escape	12
3.3.2.3	Enter	12
3.3.2.4	Menu	12
3.3.2.5	Calibration mode	12
3.3.2.6	Info mode	12
3.3.3	Navigation of data entry fields	12
3.3.4	Entry of data values, selection of data entry options	12
3.3.5	Navigation with ↑ in Display	13
3.3.6	"Save changes" dialog	13
3.3.7	Security Passwords	13
3.4	Display	13
4	Installation instruction	14
4.1	Unpacking and inspection of equipment	14
4.1.1	Panel cutout dimensional information – 1/4DIN models	14
4.1.2	Installation procedure – 1/4DIN models	15
4.1.3	Panel cutout dimensional information – 1/2DIN models	16
4.1.4	Installation procedure – 1/2DIN models	17
4.2	Connection of power supply	18
4.2.1	1/4DIN housing (panel mount)	18
4.2.2	1/2DIN housing (wall mount)	19
4.3	Connector PIN definition	20
4.3.1	TB1 and TB2 for 1/2DIN and 1/4DIN versions	20
4.3.2	TB3 and TB4 for 1/2DIN and 1/4DIN versions – Conductivity Sensors	20
4.3.3	TB3 and TB4 for 1/2DIN and 1/4DIN versions – pH/ORP Sensors	21
4.3.4	TB3 and TB4 for 1/2DIN and 1/4DIN versions – Dissolved Oxygen/Dissolved Ozone Sensors (except 58 037 221)	21
4.3.5	TB3 and TB4 for 1/2DIN and 1/4DIN versions – Dissolved Oxygen Sensor 58 037 221 only (Thornton Models only)	22
4.4	Connection of Sensor – pH/ORP	23
4.4.1	Connecting the Sensor to the VP Cable	23
4.4.2	VP Cable Assignment	24
4.4.3	Typical Wiring (Using TB3/TB4)	25
4.4.3.1	Example 1	25
4.4.3.2	Example 2	26
4.4.3.3	Example 3	27
4.4.3.4	Example 4	28
4.5	Connection of Sensor – Dissolved Oxygen/Dissolved Ozone (except 58 037 221)	29
4.5.1	Connecting the Sensor to the VP Cable	29
4.5.2	Typical Wiring using TB3/TB4	30
4.6	Connection of Sensor – Dissolved Oxygen 58 037 221	30
5	Placing transmitter in, or out, of service	31
5.1	Placing transmitter in service	31
5.2	Placing transmitter out of service	31

6	Quick Setup	32
6.1	Sensor Type Selection	32
6.2	Calibration Constant Entry	32
6.3	Measurement Units	33
6.4	Analog Outputs	33
6.5	Setpoint	33
7	Sensor Calibration	34
7.1	Enter Calibration Mode	34
7.2	Conductivity/Resistivity Calibration	34
	7.2.1 One-point Sensor Calibration	35
	7.2.2 Two-point Sensor Calibration (4-electrode sensors only)	35
7.3	Oxygen Calibration	36
	7.3.1 One-Point Sensor Calibration	36
	7.3.2 Process Calibration	36
7.4	Ozone Calibration (Mettler-Toledo Thornton M300 only)	37
	7.4.1 One-Point Sensor Calibration	37
7.5	pH Calibration	37
	7.5.1 One point calibration	38
	7.5.2 Two point calibration	38
	7.5.3 Process calibration	39
	7.5.4 mV calibration	39
7.6	Sensor Temperature Calibration	40
	7.6.1 One-Point Sensor Temperature Calibration	40
	7.6.2 Two – Point Sensor Temperature Calibration	40
7.7	Edit Sensor Calibration Constants	41
7.8	Sensor Verification	41
8	Configuration	42
8.1	Enter Configuration Mode	42
8.2	Measurement	42
	8.2.1 Channel Setup	43
	8.2.2 Derived Measurements (Thornton models only)	43
	8.2.2.1 % Rejection measurement	44
	8.2.2.2 Calculated pH (Power plant applications only)	44
	8.2.2.3 Calculated CO ₂ (Power plant applications only)	44
	8.2.3 Temperature Source	45
	8.2.4 Comp/pH/O ₂	45
	8.2.4.1 Conductivity/Resistivity Temperature Compensation	46
	8.2.4.2 pH Parameters	47
	8.2.4.3 Dissolved Oxygen Parameters	48
	8.2.5 Set Averaging	48
8.3	Analog Outputs	49
8.4	Setpoints	50
8.5	Alarm/Clean	53
	8.5.1 Alarm	53
	8.5.2 Clean	54
8.6	Display	54
	8.6.1 Measurement	54
	8.6.2 Resolution	55
	8.6.3 Backlight	55
	8.6.4 Name	55
8.7	Hold Analog Outputs	56
9	System	57
9.1	Set Language	57
9.2	USB	57
9.3	Passwords	58
	9.3.1 Changing Passwords	58
	9.3.2 Configuring Menu Access for Operator	58
9.4	Set/Clear Lockout	59
9.5	Reset	59
	9.5.1 Reset System	59
	9.5.2 Reset Meter Calibration	59
	9.5.3 Reset Analog Calibration	60

10	PID Setup	61
10.1	Enter PID Setup	62
10.2	PID Auto/Manual	63
10.3	Mode	63
10.3.1	PID Mode	63
10.4	Tune Parameters	64
10.4.1	PID Assignment & Tuning	64
10.4.2	Setpoint & Deadband	65
10.4.3	Proportional Limits	65
10.4.4	Corner Points	65
10.5	PID Display	65
11	Service	66
11.1	Diagnostics	66
11.1.1	Model/Software Revision	66
11.1.2	Digital Input	67
11.1.3	Display	67
11.1.4	Keypad	67
11.1.5	Memory	67
11.1.6	Set Relay	68
11.1.7	Read Relays	68
11.1.8	Set Analog Outputs	68
11.1.9	Read Analog Outputs	69
11.2	Calibrate	69
11.2.1	Calibrate Meter	69
11.2.1.1	Resistance	69
11.2.1.2	Temperature	70
11.2.1.3	Current	71
11.2.1.4	Voltage	71
11.2.1.5	Rg Diagnostic	72
11.2.1.6	Rr Diagnostics	72
11.2.2	Calibrate Analog	73
11.2.3	Calibrate Unlock	73
11.3	Tech Service	73
12	Info	74
12.1	Messages	74
12.2	Calibration Data	74
12.3	Model/Software Revision	75
13	Maintenance	75
13.1	For Technical Support	75
13.2	Front Panel Cleaning	75
14	Troubleshooting	76
14.1	Changing the Fuse	76
15	Accessories and Spare Parts	77
16	Specifications	78
16.1	General specifications	78
16.2	Electrical specifications for 1/2DIN and 1/4DIN versions	79
16.3	Mechanical specifications for 1/4DIN version	79
16.4	Mechanical specifications for 1/2DIN version	80
16.5	Environmental specifications for 1/2DIN and 1/4DIN versions	80
17	Default tables	81
18	Waranty	82
19	UL Statement (Pending)	82
20	pH Buffer Tables	82

1 Introduction

Statement of Intended Use – The M300 Multiparameter transmitter is a dual- channel online process instrument for measuring various properties of fluids. These include Conductivity/ Resistivity, Dissolved Oxygen, Dissolved Ozone and pH/ORP. It will interface with a variety of different Mettler-Toledo sensors, which connect to the transmitter using cables of varied lengths.

A large four line backlit Liquid Crystal Display conveys measuring data and setup information. The menu structure allows the operator to modify all operational parameters by using keys on the front panel. A menu-lockout feature, with password protection, is available to prevent the unauthorized use of the meter. The M300 Multiparameter transmitter can be configured to use its four analog and/or six relay outputs for process control.

The M300 Multiparameter transmitter is equipped with a USB communication interface. This interface provides real-time data output and complete instrument configuration capabilities for central monitoring via Personal Computer (PC).

2 Safety instructions

This manual includes safety information with the following designations and formats.

2.1 Definition of equipment and documentation symbols and designations



WARNING: POTENTIAL FOR PERSONAL INJURY.



CAUTION: possible instrument damage or malfunction.



NOTE: Important operating information.



On the transmitter or in this manual text indicates: Caution and/or other possible hazard including risk of electric shock (refer to accompanying documents)

The following is a list of general safety instructions and warnings. Failure to adhere to these instructions can result in damage to the equipment and/or personal injury to the operator.

- The M300 Transmitter should be installed and operated only by personnel familiar with the transmitter and who are qualified for such work.
- The M300 Transmitter must only be operated under the specified operating conditions (see section 16).
- Repair of the M300 Transmitter must be performed by authorized, trained personnel only.
- With the exception of routine maintenance, cleaning procedures or fuse replacement, as described in this manual, the M300 Transmitter must not be tampered with or altered in any manner.
- Mettler-Toledo accepts no responsibility for damage caused by unauthorized modifications to the transmitter.
- Follow all warnings, cautions, and instructions indicated on and supplied with this product.
- Install equipment as specified in this instruction manual. Follow appropriate local and national codes.

- Protective covers must be in place at all times during normal operation.
- If this equipment is used in a manner not specified by the manufacturer, the protection provided by it against hazards may be impaired.

WARNINGS:

Installation of cable connections and servicing of this product require access to shock hazard voltage levels.

Main power and relay contacts wired to separate power source must be disconnected before servicing.

Switch or circuit breaker shall be in close proximity to the equipment and within easy reach of the OPERATOR; it shall be marked as the disconnecting device for the equipment.

Main power must employ a switch or circuit breaker as the disconnecting device for the equipment.

Electrical installation must be in accordance with the National Electrical Code and/or any other applicable national or local codes.



NOTE: RELAY CONTROL ACTION: the M300 transmitter relays will always de-energize on loss of power, equivalent to normal state, regardless of relay state setting for powered operation. Configure any control system using these relays with fail-safe logic accordingly.



NOTE: PROCESS UPSETS: Because process and safety conditions may depend on consistent operation of this transmitter, provide appropriate means to maintain operation during sensor cleaning, replacement or sensor or instrument calibration.

2.2 Correct disposal of the unit

When the transmitter is finally removed from service, observe all local environmental regulations for proper disposal.

3 Unit overview

M300 models are available in both a 1/4DIN and 1/2DIN case size. The 1/4DIN is a panel-mount only design and the 1/2DIN models provide an integral IP65 housing for wall-, or pipe-mount.

3.1 Overview 1/4DIN

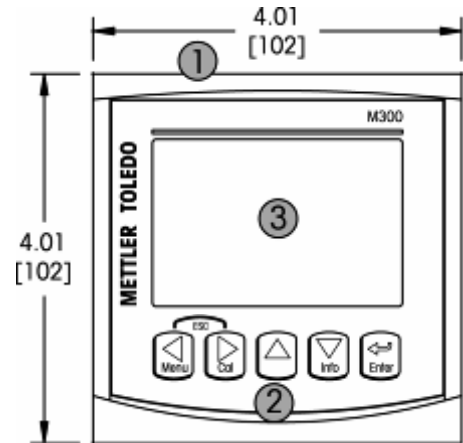
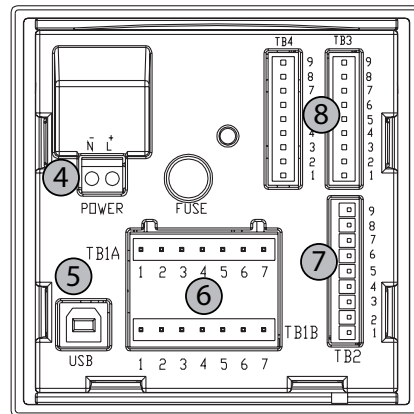

- 1 – Hard Polycarbonate case
- 2 – Five Tactile-Feedback Navigation Keys
- 3 – Four-line LCD Display
- 4 – Power Supply Terminals
- 5 – USB Interface Port
- 6 – Relay Output Terminals
- 7 – Analog Output/Digital Input Terminals
- 8 – Sensor Input Terminals

3.2 Overview 1/2DIN

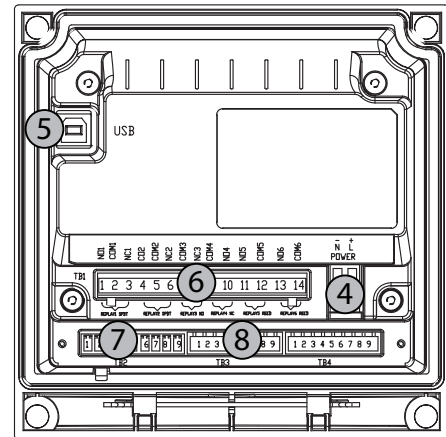
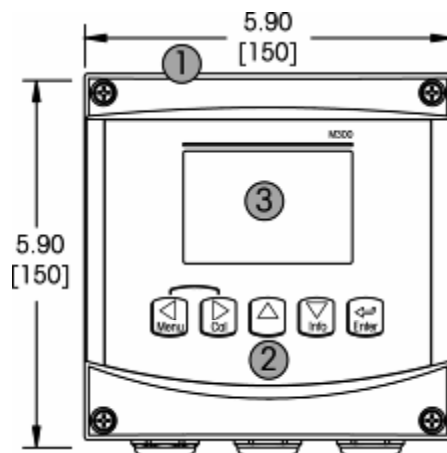

- 1 – Hard Polycarbonate case
- 2 – Five Tactile-Feedback Navigation Keys
- 3 – Four-line LCD Display
- 4 – Power Supply Terminals
- 5 – USB Interface Port
- 6 – Relay Output Terminals
- 7 – Analog Output/Digital Input Terminals
- 8 – Sensor Input Terminals

3.3 Control/Navigation Keys

3.3.1 Menu Structure

Below is the structure of the M300 menu tree:

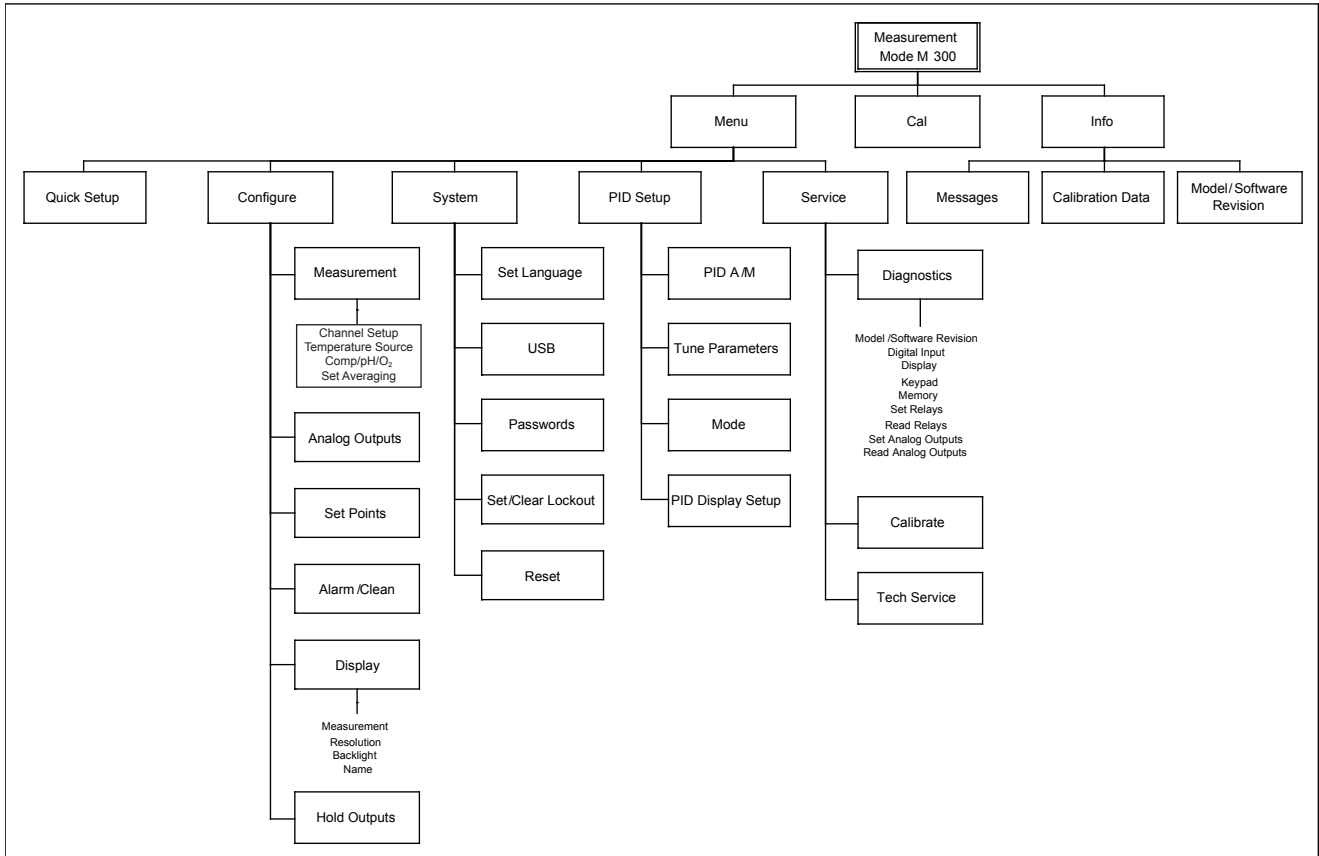

3.3.2 Navigation keys



3.3.2.1 Navigating the menu tree

Enter the desired main Menu branch with the ◀ ▶ or ▲ keys. Use the ▲ and ▼ keys to navigate through the selected Menu branch.



NOTE: In order to back up one menu page, without escaping to the measurement mode, move the cursor under the UP Arrow character at the bottom right of the display screen and press [Enter].

3.3.2.2 Escape

Press the ◀ and ▶ key simultaneously (escape) to return to the Measurement mode.

3.3.2.3 Enter

Use the ↵ key to confirm action or selections.

3.3.2.4 Menu

Press the ◀ key to access the main Menu.

3.3.2.5 Calibration mode

Press the ▶ key to enter Calibration Mode.

3.3.2.6 Info mode

Press the ▼ key to enter Info Mode

3.3.3 Navigation of data entry fields

Use the ▶ key to navigate forward or the ◀ key to navigate backwards within the changeable data entry fields of the display.

3.3.4 Entry of data values, selection of data entry options

Use the ▲ key to increase or the ▼ key to decrease a digit. Use the same keys to navigate within a selection of values or options of a data entry field.

NOTE: Some screens require configuring multiple values via the same data field (ex: configuring multiple setpoints). Be sure to use the ▶ or ◀ key to return to the primary field and the ▲ or ▼ key to toggle between all configuration options before entering to the next display screen.



3.3.5 Navigation with ↑ in Display

If a ↑ is displayed on the bottom right hand corner of the display, you can use the ► or the ◀ key to navigate to it. If you click [ENTER] you will navigate backwards through the menu (go back one screen). This can be a very useful option to move back up the menu tree without having to exit into the measuring mode and re-enter the menu.

3.3.6 "Save changes" dialog

Three options are possible for the "Save changes" dialog: Yes & Exit (Save changes and exit to measuring mode), "Yes & ↑" (Save changes and go back one screen) and "No & Exit" (Don't save changes and exit to measuring mode). The "Yes & ↑" option is very useful if you want to continue configuring without having to re-enter the menu.

3.3.7 Security Passwords

The M300 transmitter allows a security lock-out of various menus. If the security lock-out feature of the transmitter has been enabled, a security password must be entered to allow access to the menu. See section 9.3 for more information.

3.4 Display



NOTE: In the event of an alarm or other error condition the M300 Transmitter will display a flashing ⚠ in the upper right corner of the display. This symbol will remain until the condition that caused it has been cleared.



NOTE: During calibrations, clean, Digital In with Analog Output/Relay/USB in Hold state, a flashing H will appear in the upper left corner of the display. This symbol will remain for 20 seconds until after the calibration or clean is completed. This symbol will also disappear when Digital In is deactivated.

4 Installation instruction

4.1 Unpacking and inspection of equipment

Inspect the shipping container. If it is damaged, contact the shipper immediately for instructions. Do not discard the box.

If there is no apparent damage, unpack the container. Be sure all items shown on the packing list are present.

If items are missing, notify Mettler-Toledo immediately

4.1.1 Panel cutout dimensional information – 1/4DIN models

1/4DIN Model transmitters are designed for panel-mount installation only. Each transmitter is supplied with mounting hardware to provide fast and simple installation to a flat panel or flat enclosure door. To insure a good seal and maintain NEMA/IP integrity of installation, the panel or door must be flat and have a smooth finish. Hardware consists of:

Two – Snap-on Mounting brackets

One – Mounting gasket seal

Transmitter dimensions and mounting are shown in the figures below.

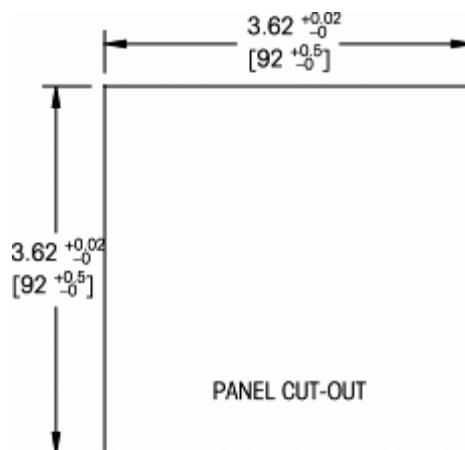

4.1.2 Installation procedure – 1/4DIN models

- Make cutout in panel (see dimensions cutout drawing).
- Be sure surface surrounding cutout is clean, smooth and free of burrs.
- Slide face gasket (supplied with transmitter) around transmitter from the back of the unit.
- Place transmitter into cutout hole. Be sure there are no gaps between the transmitter and panel surface.
- Place the two mounting brackets on either side of the transmitter as shown
- While holding transmitter firmly into the cutout hole, push the mounting brackets toward the backside of panel
- Once secure, use a screwdriver to tighten the brackets against the panel
- Face gasket will compress between transmitter and panel



CAUTION: Do not over tighten brackets

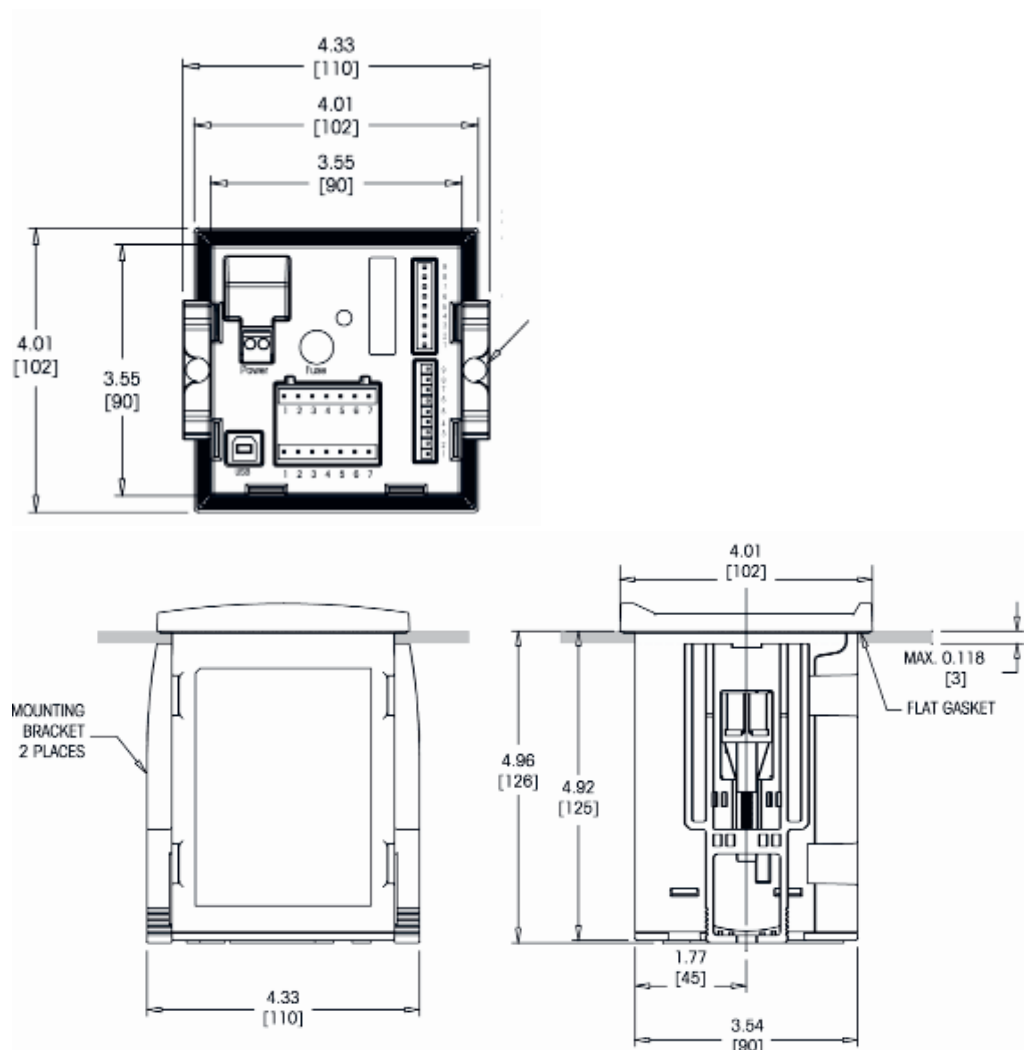

4.1.3 Panel cutout dimensional information – 1/2DIN models

1/2DIN Model transmitters are designed with an integral rear cover for stand-alone wall mount installation.

The unit may also be wall mounted using the integral rear cover. See installation instructions in Section 4.1.4.

Below are cut-out dimensions required by the 1/2DIN models when mounted within a flat panel or on a flat enclosure door. This surface must be flat and smooth. Textured or rough surfaces are not recommended and may limit the effectiveness of the gasket seal provided.

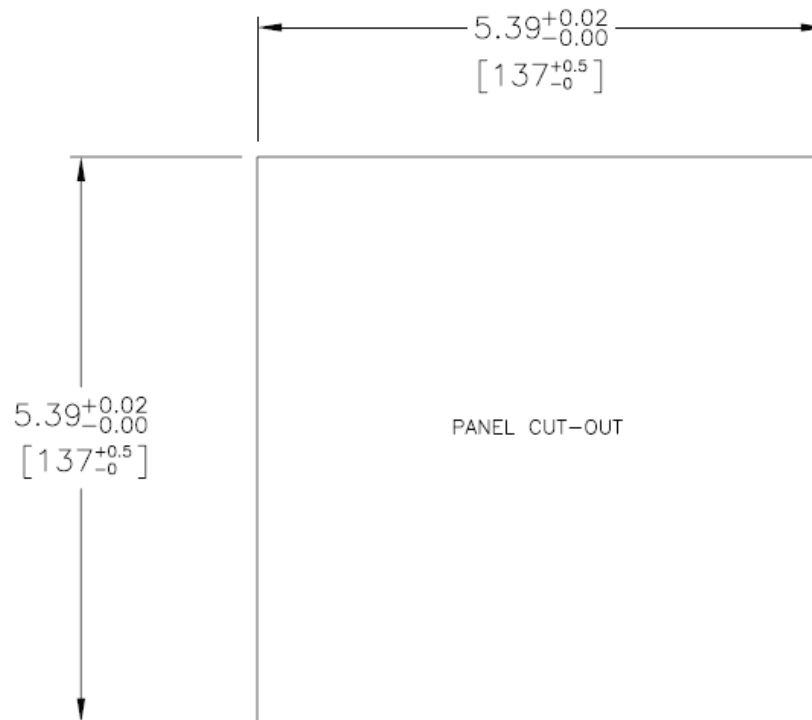

Optional hardware accessories are available that allow for panel- or pipe-mount. Refer to Section [15](#) for ordering information.

4.1.4 Installation procedure – 1/2DIN models

For Wall Mount:

- Remove rear cover from front housing.
- Start by unscrewing the four screws located on the face of the transmitter, in each corner. This allows the front cover to swing away from the rear housing.
- Remove the hinge-pin by squeezing the pin from each end. This allows the front housing to be removed from the rear housing
- Drill out wall-mount breakthroughs in the rear housing.
- Mount rear housing to wall using appropriate mounting hardware for wall surface. Be sure it is level and securely fastened and the installation adheres to any and all clearance dimensions required for transmitter service and maintenance.
- Insert two black protective covers (supplied with the M300 transmitter) over the fixing hardware and into the space on the inside back cover, as shown in the drawing below. This is necessary to maintain unit integrity.
- Replace the front housing to the rear housing. The unit is ready to be wired.

For Pipe Mount:

- Use only manufacturer-supplied components for pipe-mounting the M300 transmitter and install per the supplied instructions. See section 15 for ordering information.

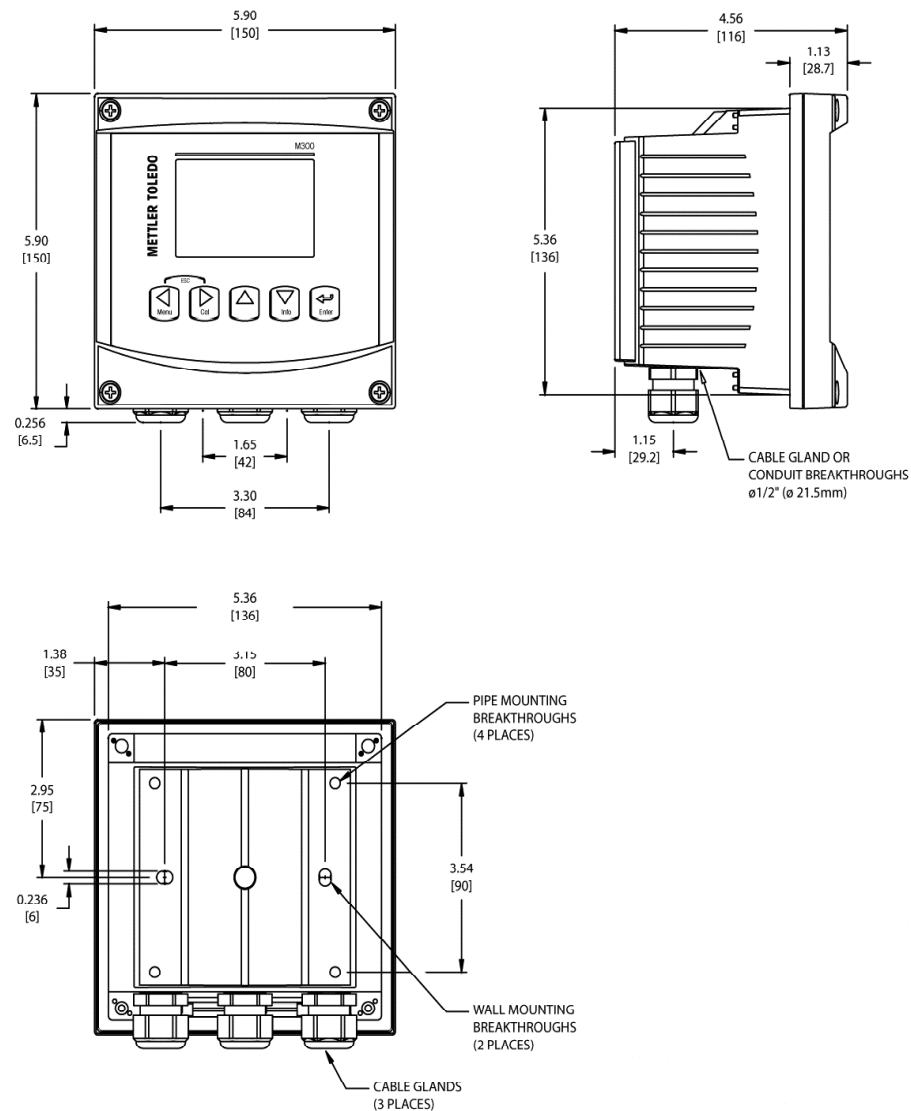

4.2 Connection of power supply

All connections to the transmitter are made on the rear panel of all models.



Be sure power to all wires is turned off before proceeding with the installation. High voltage may be present on the input power wires and relay wires.

A two-terminal connector on the rear panel of all M300 models is provided for power connection. All M300 models are designed to operate from a 20–30 VDC or a 100 to 240 VAC power source. Refer to specifications for power requirements and ratings and size power wiring accordingly.

The terminal block for power connections is labeled "Power" on the rear panel of the transmitter. One terminal is labeled **-N** for the Neutral wire and the other **+L** for the Line (or Load) wire. There is no earth ground terminal on the transmitter. For this reason the internal power wiring within the transmitter is double insulated and the product label designates this using the  symbol.

4.2.1 1/4DIN housing (panel mount)

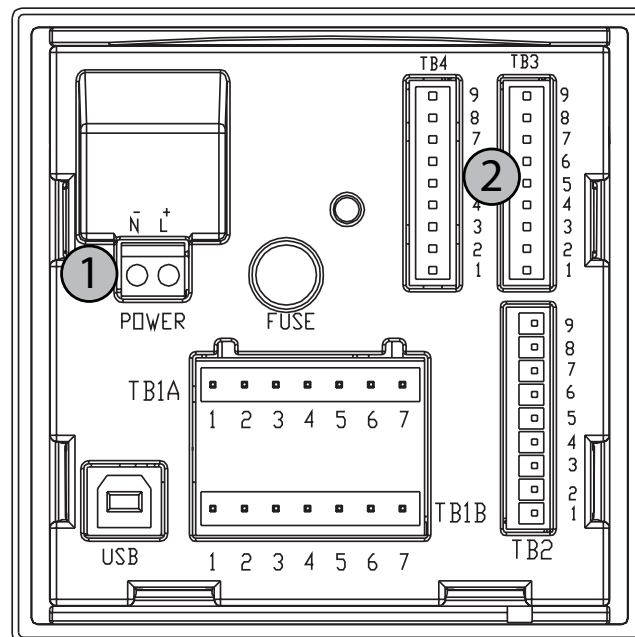

- 1 Connection of power supply
- 2 Terminal for sensors

4.2.2 1/2DIN housing (wall mount)

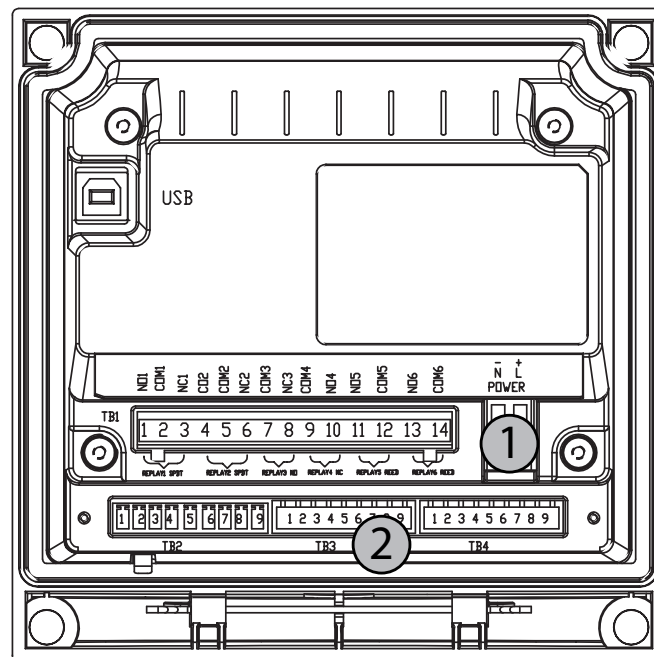

- 1 Connection of power supply
- 2 Terminal for sensors

4.3 Connector PIN definition

4.3.1 TB1 and TB2 for 1/2DIN and 1/4DIN versions

Power connections are labeled **-N** for Neutral and **+L** for Line, for 100 to 240 VAC or 20–30 VDC.

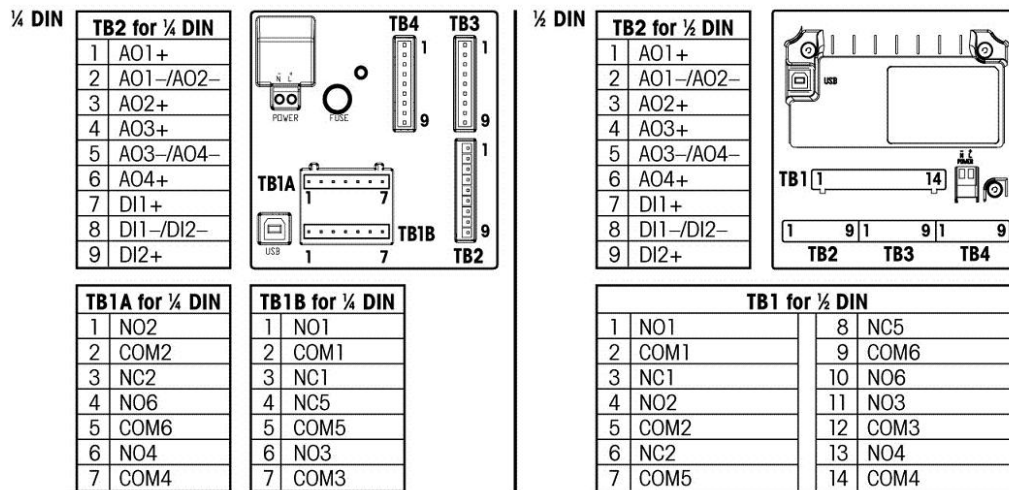

NO = normally open (contact is open if unactuated). NC = normally closed (contact is closed if unactuated).

NO = normally open (contact open if un-actuated).

NC = normally closed (contact closed if un-actuated).

4.3.2 TB3 and TB4 for 1/2DIN and 1/4DIN versions – Conductivity Sensors

TB 3 provides access to channel A signal inputs, TB4 provides access to channel B signal inputs.

Conductivity sensors use 58 080 20X or 1XXX-67 series cables.

Pin no.	Sensor wire Color	Function
1	white	Cnd inner 1
2	white/blue	Cnd outer 1
3	blue	Cnd inner 2
4	black & bare shield	Cnd outer 2/Shield
5	–	not used
6	clear	RTD ret/GND
7	red	RTD sense
8	green	RTD
9	–	+5V

4.3.3 TB3 and TB4 for 1/2DIN and 1/4DIN versions – pH/ORP Sensors

pH/ORP sensors use 52 300 1XX series VP cables, or 10 001 XX02 series AS9 cables (ORP only).

Pin no.	Sensor wire Color	Function
1	Coax inner/transparent	Glass
2		not used
3*	Coax shield/red	Reference
4*	green/yellow, blue	Solution GND/Shield
5	–	not used
6	white	RTD ref/GND
7		RTD sense
8	green	RTD
9	–	+5V
	grey (no connection)	



NOTE: * Install Jumper 3 to 4 when used without Solution Ground

4.3.4 TB3 and TB4 for 1/2DIN and 1/4DIN versions – Dissolved Oxygen/ Dissolved Ozone Sensors (except 58 037 221)

These sensors use 52 300 1XX series VP cables.

Pin no.	Sensor wire Color	Function
1*	–	not used
2	Coax Shield/red	Anode
3*	–	not used
4*	green/yellow	Shield/GND
5	Coax Inner/transparent	Cathode
6	white, grey	Temperature, Guard
7	–	not used
8	green	Temperature
9	–	+5V

Blue wire not used



NOTE: * Install Jumper (supplied) 1 to 3 to 4 when using Thornton Dissolved Oxygen and Ozone Sensors

4.3.5 TB3 and TB4 for 1/2DIN and 1/4DIN versions – Dissolved Oxygen Sensor 58 037 221 only (Thornton Models only)

This sensor uses 1XXX-67 series cables.

Pin no.	Sensor wire Color	Function
1	white	Signal
2	white/blue,	Range
3	–	
4	black, bare shield	Shield, Ground
5	–	
6	Transparent	Ground
7	Red	Temperature
8	Green	Temperature
9	Blue	+5V

4.4 Connection of Sensor – pH/ORP

4.4.1 Connecting the Sensor to the VP Cable

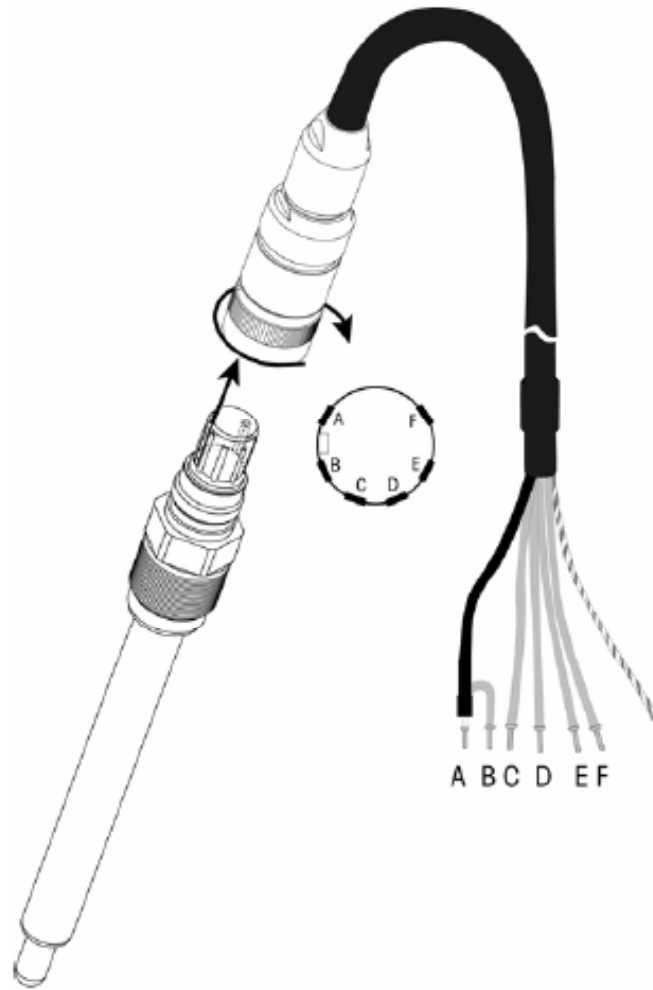

NOTE: Cable lengths > 20 m can worsen the response during pH measurement. Be sure to observe the sensor instruction manual.

4.4.2 VP Cable Assignment

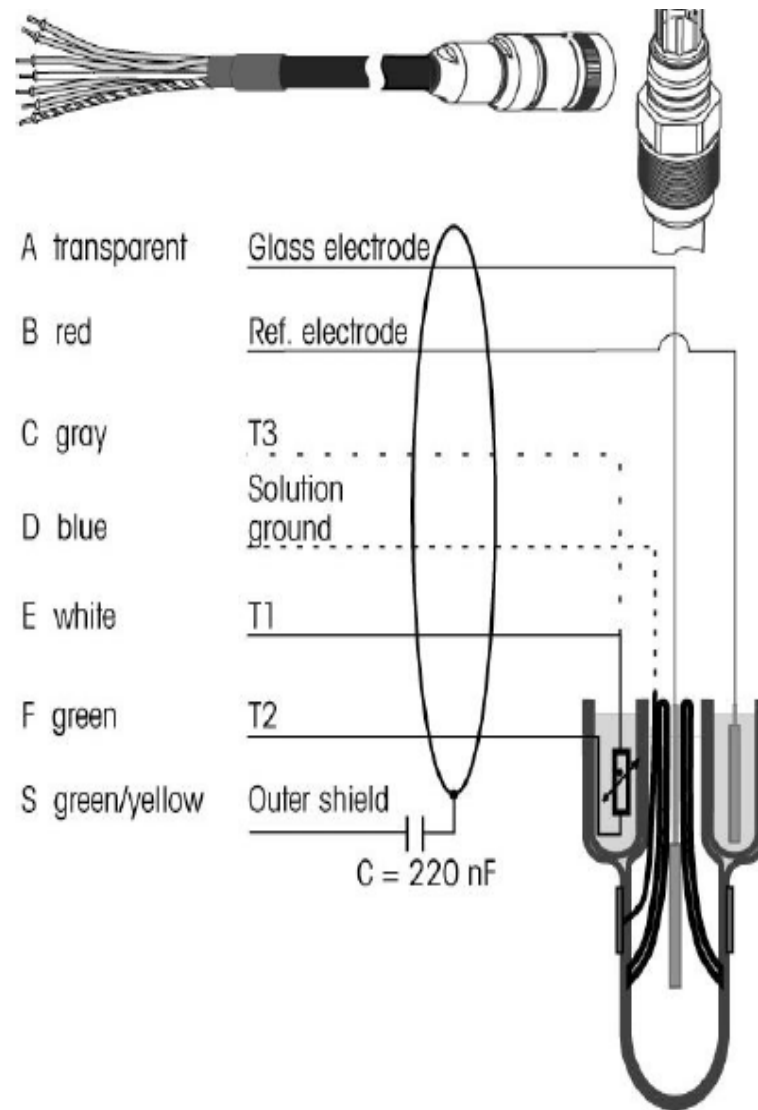

T1/T2 = Temperature probe for 2-wire connection
 T3 = Additional connection for temperature probe (3-wire connection)

4.4.3 Typical Wiring (Using TB3/TB4)

4.4.3.1 Example 1

pH measurement without Solution Ground

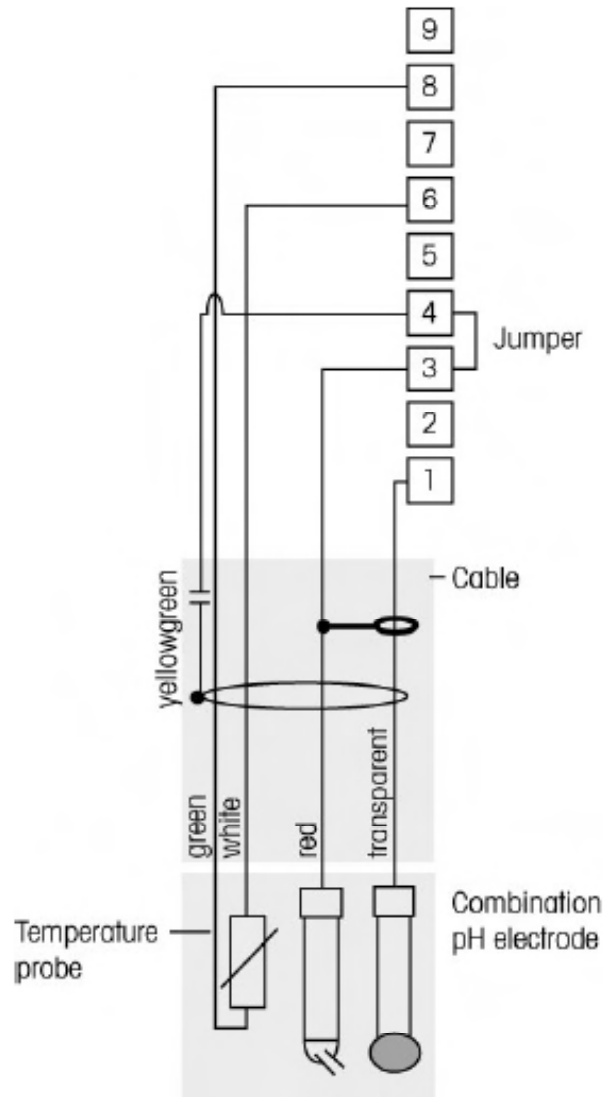

NOTE: Jumper Terminals 3 and 4.

Wire colors only valid for connection with VP cable; blue and grey not connected.

- 1 – Glass
- 2 – Not used
- 3 – Reference
- 4 – Shield/GND
- 5 – Not used
- 6 – Solution GND/RTD ret
- 7 – Not used
- 8 – RTD
- 9 – Not used

4.4.3.2 Example 2

pH measurement with Solution Ground

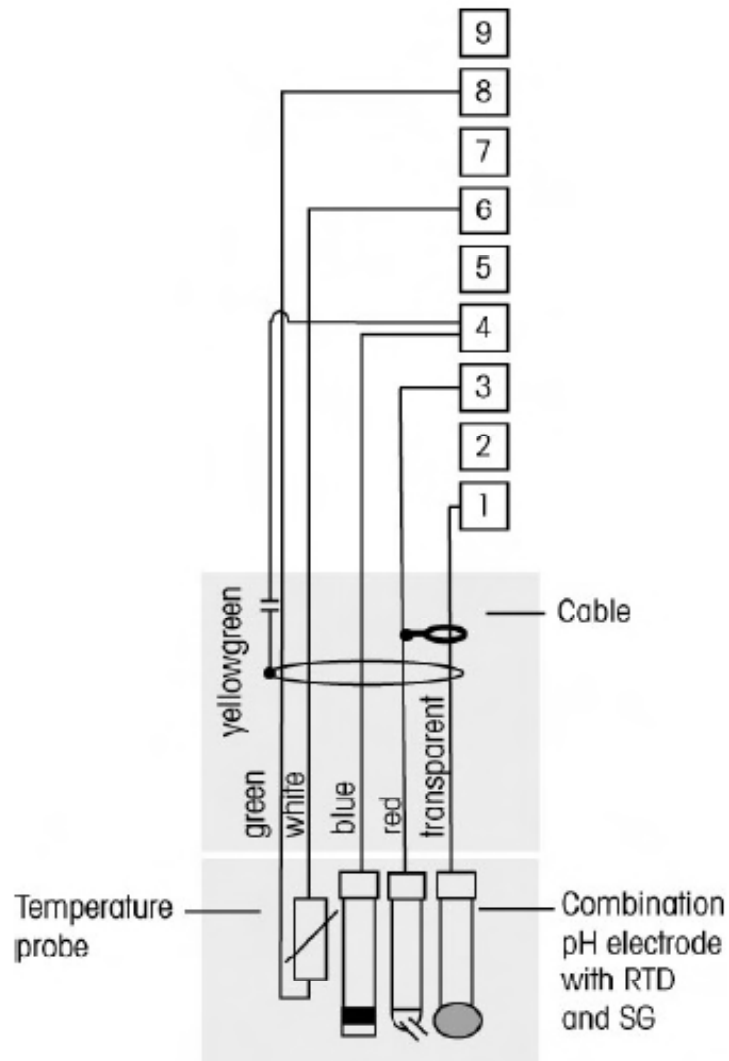

NOTE: Wire colors only valid for connection with VP cable, grey not connected.

- 1 – Glass
- 2 – Not used
- 3 – Reference
- 4 – Shield/Solution GND
- 5 – Not used
- 6 – GND/RTD ref
- 7 – Not used
- 8 – RTD
- 9 – Not used

4.4.3.3 Example 3

ORP (redox) measurement (temperature optional)

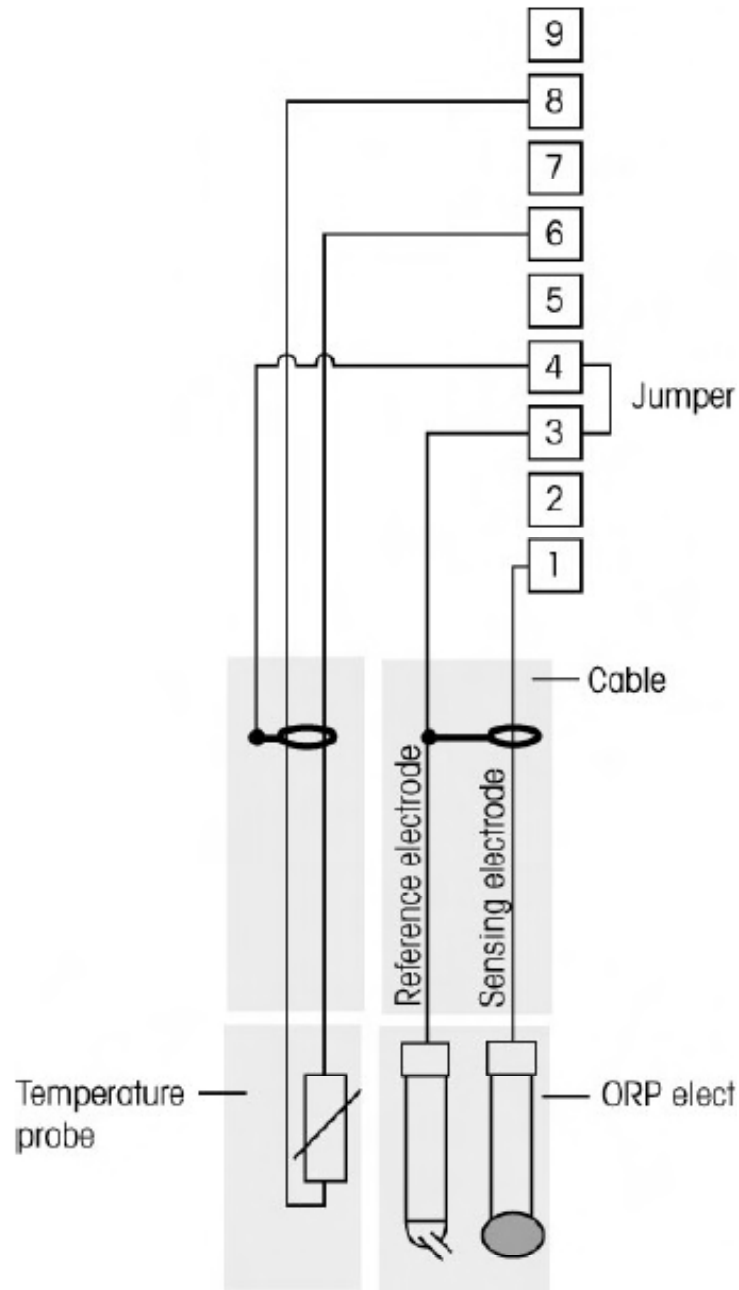

NOTE: Jumper Terminal 3 and 4

- 1 – Platinum
- 2 – Not used
- 3 – Reference
- 4 – Shield/GND
- 5 – Not used
- 6 – RTD ret
- 7 – Not used
- 8 – RTD
- 9 – Not used

4.4.3.4 Example 4

ORP measurement with pH Solution ground electrode (e.g. InPro 3250SG, InPro 4800SG).

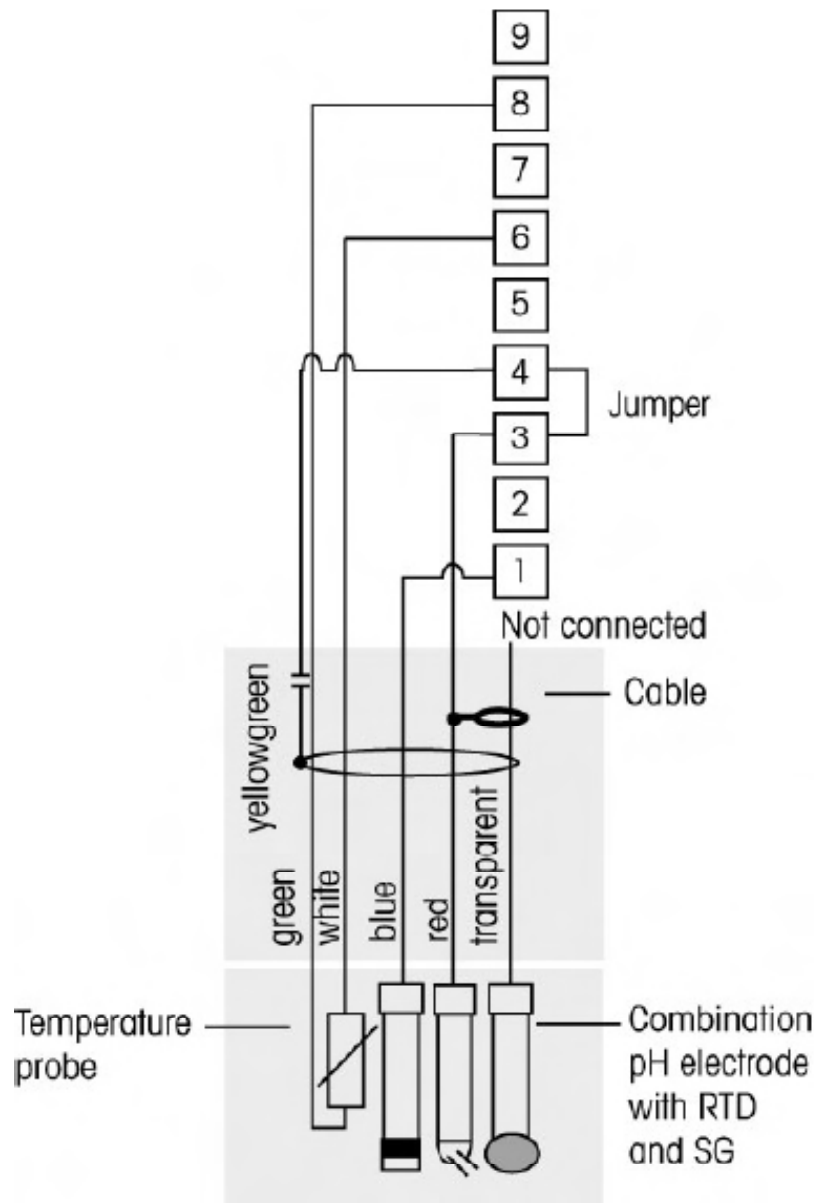

NOTE: Jumper Terminal 3 and 4

- 1 – Platinum
- 2 – Not used
- 3 – Reference
- 4 – Shield/GND
- 5 – Not used
- 6 – RTD ret
- 7 – Not used
- 8 – RTD
- 9 – Not used

4.5 Connection of Sensor – Dissolved Oxygen/Dissolved Ozone (except 58 037 221)

4.5.1 Connecting the Sensor to the VP Cable

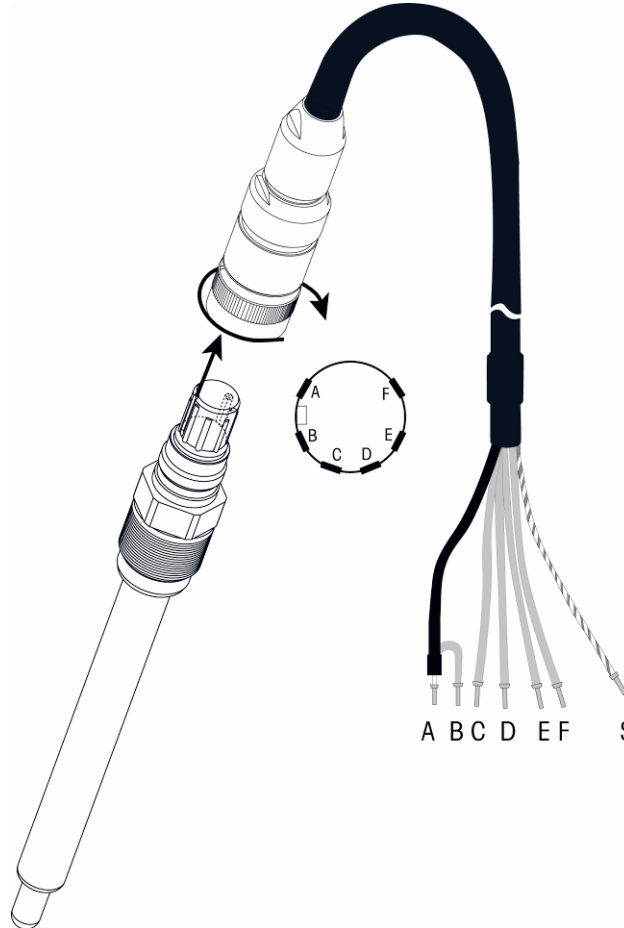

NOTE: Be sure to observe the sensor instruction manual.

4.5.2 Typical Wiring using TB3/TB4

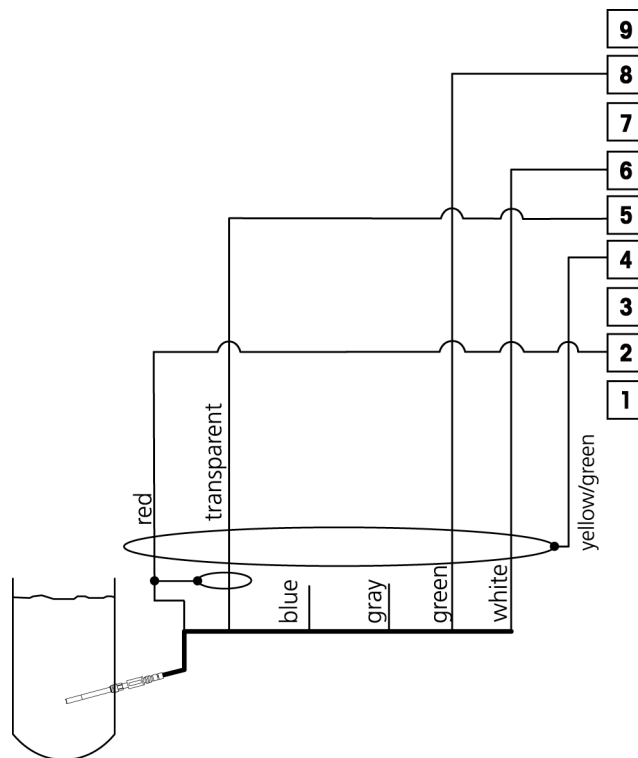

NOTE: Wire colors only valid for connection with VP cable, blue not connected.

M300 connector:

- 1 – not used
- 2 – Anode
- 3 – not used
- 4 – Shield/GND
- 5 – Cathode
- 6 – NTC ref, Guard
- 7 – Not used
- 8 – NTC 2
- 9 – not used

4.6 Connection of Sensor – Dissolved Oxygen 58 037 221

This sensor consists of a Thornton Long Life dissolved oxygen probe that comes directly wired to a preamplifier box. The preamplifier connects to the M300 using a 1XXX-67 series cable. Use the connections shown in the last table of section 4.3 and follow the additional instructions supplied with the sensor.

5 Placing transmitter in, or out, of service

5.1 Placing transmitter in service



After connecting the transmitter to power supply circuit, it will be active as soon as the circuit is powered.

5.2 Placing transmitter out of service

First disconnect the unit from the main power source, then disconnect all remaining electrical connections. Remove the unit from the wall/panel. Use the installation instruction in this manual as reference for dis-assembling mounting hardware.

6 Quick Setup

(PATH: Menu/Quick Setup)

Select Quick Setup and press the [ENTER] key. Enter the security code if necessary (see section 9.3)

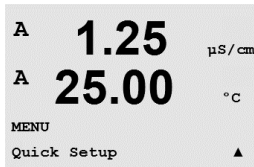

While in Measurement mode press the [MENU] key to bring up the Menu selection. Select Quick Setup and press the [ENTER] key.

Convention:

1st line on display => a
 2nd line on display => b
 3rd line on display => c
 4th line on display => d

Only lines a and c can be configured in Quick Setup. Go to the Configuration Menu to configure remaining lines.

6.1 Sensor Type Selection

Select the type of sensor to be used with the M300 transmitter. Choices are 'Cond(2)', used for all 2-Electrode conductivity sensors, 'Cond (4)' for all 4-electrode conductivity sensors, 'O₂(I)', for most Dissolved Oxygen sensors, 'O₂(V)', for the 58 037 221 Dissolved Oxygen sensor (Thornton models only), 'O₃', for Dissolved Ozone sensors (Thornton models only) and pH/ORP for pH or ORP sensors. Press [ENTER].

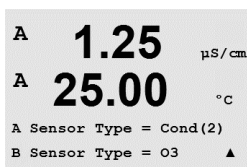

NOTE: The labels 'A' and 'B' designate sensor channel inputs. These labels appear in the data input fields where configuration of both channels is possible.

6.2 Calibration Constant Entry

If a conductivity sensor is selected, enter the calibration constants from the sensor label or certificate. Conductivity cell constants are primary 'p'. For 2-electrode sensors, leave A = 0.0000. Temperature constants are secondary 's'. Press [ENTER] to continue.



6.3 Measurement Units

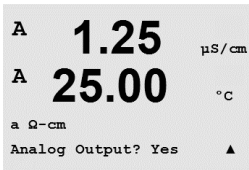

Select a or c and select the units of measurement for each. Example: Sensor Type A = Cond(2) and Sensor B Type = O₃. By selecting a and S/cm as units, the conductivity value will be displayed on the 1st line. By selecting c and O₃ as units, the dissolved Ozone concentration will be displayed on the 3rd line of the display. By selecting a and °C as units, the temperature will be displayed on the 1st line. By selecting c and °C as units, the temperature will be displayed on the 3rd line.

6.4 Analog Outputs



On the same screen above, by selecting Yes, the linear 4–20 mA analog output Aout1 will be set up when [Enter] is pressed. Additionally, Aout3 may be configured if measurement c is selected. Selecting No means that no analog output is set up. Aout1 min, Aout1 max are the minimum and maximum measurement values for the 4 and 20mA values respectively. Be sure to enter the correct unit multiplier. To configure additional outputs, use the Configuration Menu. Press [Enter].

6.5 Setpoint

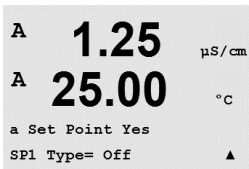

After configuring the Analog Output, a Setpoint can be configured for that measurement. If No is selected and [ENTER] is pressed then the Quick Setup is done and the menus are exited without setting up any Setpoint. To establish a Setpoint for measurement a (and/or c), select Yes and select one of the following Setpoint Types:

- High (High value has to be set)
- Low (Low value has to be set)
- Between (High and Low value has to be set)
- Outside (High and Low value has to be set)

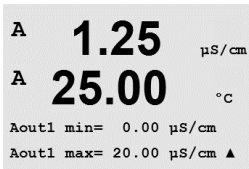

Additionally, when conductivity is selected as the sensor type, the following Setpoint Types are available for Mettler Toledo Thornton M300 only:

- %USP (% safety margin below U.S. Pharmacopoeia limits)
- EP PW (% safety margin below European Pharmacopoeia limits for Purified Water)
- EPWFI (% safety margin below European Pharmacopoeia limits for Water for Injection)

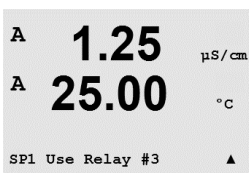

After setting the Setpoint value(s) and its units multiplier, select a Relay (none, 2, 3, 4, 5, 6) for that Setpoint. The Relay delay is set to 10 seconds and the Hysteresis is set to 5%. Press [ENTER].



NOTE: Relay 1 is reserved for the 'Clean' function (see Sect 8.6) by default and is not available for Quick Setup.

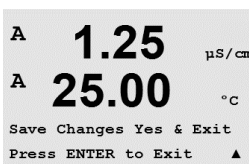

If [ENTER] is pressed again the Setpoint setup is stored and any previous use of the Relay is cancelled. If No is selected then the menu is exited without saving the entered settings.

7 Sensor Calibration

(PATH: Cal)

The calibration key  allows the user one-touch access to Sensor calibration and verification features. (Thornton models also allow access to Meter and Analog Output calibration.)



NOTE: During Calibration, a flashing 'H' in the upper left corner of the display indicates a calibration is in process with a Hold condition active.

7.1 Enter Calibration Mode

While in Measurement mode press the  key.

Press the  or  key to select the type of calibration desired.

After selecting 'Sensor', use the  key to move to the next line. Select the channel 'A' or 'B' to be calibrated. Select the desired Sensor Calibration task. The choices for each sensor type are:
 Conductivity = Conductivity, Resistivity, Temperature, Edit, Verify
 Oxygen = Oxygen, Temperature, Edit, Verify
 Ozone = Ozone, Temperature, Edit, Verify
 pH = pH, mV, Temperature, Edit pH, Edit mV, Verify
 Press [ENTER].

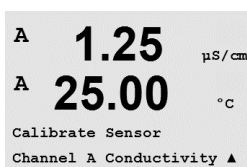

7.2 Conductivity/Resistivity Calibration

This feature provides the ability to perform a one-point or two-point Conductivity or Resistivity 'Sensor' calibration. The procedure described below works for both types of calibrations. There is no reason to perform a two-point calibration on a two-electrode conductivity sensor. Four electrode sensors do require a two-point calibration. It is also not practical to calibrate resistivity sensors using (low conductivity) reference solutions. It is recommended that resistivity sensors be sent back to the factory for calibration. Consult factory for assistance.

NOTE: When performing calibration on a conductivity or resistivity sensor, results will vary depending on the methods, calibration apparatus and/or quality of reference standards used to perform the calibration.

Enter Conductivity Sensor Calibration mode as described in section [7.1](#).

When configuring Thornton model transmitters, after selecting the desired sensor calibration and pressing [ENTER], the next screen will ask to select the type of temperature compensation mode desired DURING the calibration process. The choices are 'None', 'Standard', 'Light 84', 'Std 75°C', 'Linear = 02.0%/°C' (user selectable value), 'Glycol.5', 'Glycol1', and 'Alcohol'. All other models operate in the Standard Compensation mode. Press [ENTER].

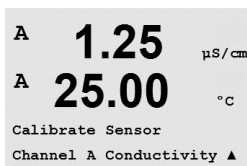

7.2.1 One-point Sensor Calibration

(Display reflects typical Conductivity Sensor calibration)

```
A 1.25 μS/cm
A 25.00 °C
Conductivity Calibration
Type = 1 point ▲
```

Select 1 point Calibration and press [ENTER].

Enter the Value of calibration Point 1 and then press the [ENTER] key to start calibration. The value in the 2nd text line is the actual measured value from the sensor prior to calibration.

```
A 1.25 μS/cm
A 25.00 °C
A Point1 = 1.413 μS/cm
A C = 1.250 μS/cm ▲
```

After the calibration the Multiplier or slope calibration factor 'M' and the Adder or offset calibration factor 'A' are displayed.

Select Yes to save the calibration values and the Successful Calibration is confirmed on the display.

```
A 1.25 μS/cm
A 25.00 °C
C M=0.1000 A=0.0000
Save Calibration Yes ▲
```

7.2.2 Two-point Sensor Calibration (4-electrode sensors only)

Enter Conductivity Sensor Calibration mode as described in section 7.1.

Select 2 point Calibration and press [ENTER].

CAUTION: Rinse sensors with a high-purity water solution between calibration points to prevent contamination of the reference solutions.

```
A 1.25 μS/cm
A 25.00 °C
Conductivity Calibration
Type = 2 point ▲
```

Enter the Value of Point 1 and press the [ENTER] key. Place the sensor into the second reference solution.

Enter the Value of Point 2 and press the [ENTER] key to start the calibration.

```
A 1.25 μS/cm
A 25.00 °C
A Point2 = 0.055 μS/cm
A C = 0.057 μS/cm ▲
```

After the calibration the Multiplier or slope calibration factor 'M' and the Adder or offset calibration factor 'A' are displayed.

Select Yes to save the calibration values and the Successful Calibration is confirmed on the display.

```
A 1.25 μS/cm
A 25.00 °C
C M=0.1000 A=0.0000
Save Calibration Yes ▲
```

7.3 Oxygen Calibration

Dissolved Oxygen calibration is performed as either a one-point or process calibration.

7.3.1 One-Point Sensor Calibration

Before air calibration, for highest accuracy, enter the barometric pressure as in section 8.2.1.6.

Enter Oxygen Calibration mode as described in section 7.1.

A DO sensor calibration is always either a one point Air (Slope) or a Zero (Offset) calibration. A one point slope calibration is done in air and a one point offset calibration is done at 0 ppb DO. A one-point zero dissolved oxygen calibration is available but not normally recommended since zero DO is very hard to achieve

Select 1 point followed by either Slope or ZeroPt as the calibration type. Press [ENTER].

```
A 1.25  μS/cm
A 25.00 °C
Calibrate Sensor
Channel B Oxygen ▲
```

```
A 1.25  μS/cm
A 25.00 °C
O2 Calibration
Type = 1 point Slope ▲
```

```
A 1.25  μS/cm
A 25.00 °C
B Point1 = 100.0 ppb
B O2 = 101.3 ppb ▲
```

Enter the value for Point 1 including a decimal point and units. The value in the second text line is the value being measured by the transmitter and sensor in the units selected by the user. Press [ENTER] when this value is stable to perform the calibration.

After the calibration the slope calibration factor S and the offset calibration factor Z are displayed.

Select Yes to save the calibration values and the successful Calibration is confirmed on the display.

```
A 1.25  μS/cm
A 25.00 °C
O2 S=0.1000 Z=0.0000
Save Calibration Yes ▲
```

7.3.2 Process Calibration

Enter Oxygen Calibration mode as described in section 7.1.

Select Process followed by either Slope or ZeroPt as the calibration type. Press [ENTER]

Take a sample and press the [ENTER] key again to store the current measuring Value. To show the ongoing Calibration Process an H is displayed in the top left hand corner.

```
A 1.25  μS/cm
A 25.00 °C
O2 Calibration
Type = Process Slope ▲
```

```
A H 1.25  μS/cm
A 25.00 °C
B Point1 = 100.0 ppb
B O2 = 101.3 ppb ▲
```

After determining the O₂ Value of the Sample press the ► key again to proceed with the calibration. Enter the O₂ value of the sample then press the [ENTER] key to start calibration.

After the calibration the slope calibration factor S and the offset calibration factor Z are displayed. Select Yes to save the new calibration values and the successful Calibration is confirmed on the display. The H in the top left hand corner disappears after 20 seconds.

```
A 1.25  μS/cm
A 25.00 °C
O2 S=0.1000 Z=0.0000
Save Calibration Yes ▲
```

7.4 Ozone Calibration (Mettler-Toledo Thornton only)

Dissolved Ozone calibration is performed as a 1 point calibration and must be performed quickly because ozone decays rapidly into oxygen, especially at warm temperatures.

7.4.1 One-Point Sensor Calibration

```

A 1.25 µS/cm
A 25.00 °C
Calibrate Sensor
Channel B Ozone ▲
  
```

Enter Ozone Calibration mode as described in section [7.1](#).

Ozone sensor calibration is always either a one point Comparison (Slope) or a Zero (Offset) calibration. A one point slope calibration is always obtained from a comparison instrument or colorimetric test kit and a one point offset calibration is done in air or in Ozone-free water.

```

A 1.25 µS/cm
A 25.00 °C
O3 Calibration
Type = 1 point Slope ▲
  
```

Select 1 point followed by either Slope or ZeroPt as the calibration type. Press [ENTER].

Enter the value for Point 1 including a decimal point and units. The value in the second text line is the value being measured by the transmitter and sensor in the units selected by the user. Press [ENTER] when this value is stable to perform the calibration.

```

A 1.25 µS/cm
A 25.00 °C
B Point1 = 0.147 ppm O3
B O3 = 0.164 ppm ▲
  
```

After the calibration the slope calibration factor S and the offset calibration factor Z are displayed.

```

A 1.25 µS/cm
A 25.00 °C
O3 S=0.1000 Z=0.0000
Save Calibration Yes ▲
  
```

Select Yes to save the calibration values and the successful Calibration is confirmed on the display.

7.5 pH Calibration

For pH sensors, the M300 transmitter features one-point, two-point (Auto or Manual mode) or process calibration with 8 preset buffer sets or manual buffer entry. Buffer values refer to 25 °C. To calibrate the instrument with automatic buffer recognition, you need a standard pH buffer solution that matches one of these values. (See section [8.2.3.2](#) for configuring modes and selecting buffer sets)

Enter pH Calibration mode as described in section [7.1](#).

```

A 1.25 µS/cm
A 25.00 °C
Calibrate Sensor
Channel B pH ▲
  
```

7.5.1 One point calibration

Select 1 point Calibration.

```

A  1.25  μS/cm
A  25.00  °C
pH Calibration
Type = 1 point  ▲
  
```

Place the electrode in the buffer solution and press the [ENTER] key to start the calibration.

```

A  1.25  μS/cm
A  25.00  °C
Press ENTER when
Sensor is in Buffer 1  ▲
  
```

Auto mode: The display shows the buffer that the transmitter has recognized (Point 1) and the measured value.

Manual mode: Enter the buffer value and press [ENTER] to proceed.

As soon as the drift conditions have stabilized (or [ENTER] pressed in manual mode) the display changes to show the slope calibration factor S and the offset calibration factor Z.

```

A  1.25  μS/cm
A  25.00  °C
B Point1 = 7.000 pH ...
B   pH = 7.492 pH  ▲
  
```

Select Yes to save the calibration values and the successful Calibration is confirmed on the display.

```

A  1.25  μS/cm
A  25.00  °C
pH S=100.0% Z=7.000pH
Save Calibration Yes  ▲
  
```

7.5.2 Two point calibration

Select 2 point Calibration.

Place the electrode in the first buffer solution and then press the [ENTER] key.

```

A  1.25  μS/cm
A  25.00  °C
pH Calibration
Type = 2 point  ▲
  
```

Auto mode: The display shows the buffer that the transmitter has recognized (Point 1) and the measured value.

Manual mode: Enter the buffer value and press [ENTER] to proceed.

As soon as the drift conditions have stabilized (or [ENTER] pressed in manual mode) the display changes and prompts you to place the electrode in the second buffer solution.

```

A  1.25  μS/cm
A  25.00  °C
B Point2 = 10.53 pH ...
B   pH = 11.01 pH  ▲
  
```

As soon as the drift conditions have stabilized (or [ENTER] pressed in manual mode) the display changes to show the slope calibration factor S and the offset calibration factor Z.

Select Yes to save the calibration values and the successful Calibration is confirmed on the display.

```

A  1.25  μS/cm
A  25.00  °C
pH S=100.0% Z=7.000pH
Save Calibration Yes  ▲
  
```

7.5.3 Process calibration

Select Process Calibration.

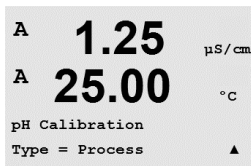

Take a sample and press the [ENTER] key again to store the current measuring Value. To show the ongoing Calibration Process an H is displayed in the top left hand corner.

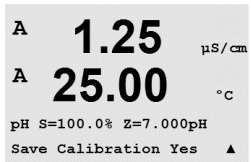

After determining the pH Value of the Sample, press the ► key again to proceed with the calibration.

Enter the pH value of the sample then press the [ENTER] key to start calibration.

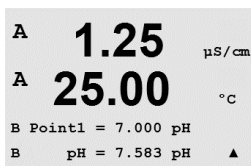

After the calibration the slope calibration factor S and the offset calibration factor Z are displayed. Select Yes to save the new calibration values and the successful Calibration is confirmed on the display.

7.5.4 mV calibration

Enter mV Calibration mode as described in section [7.1](#).



The user can now enter Point 1. The offset calibration factor is calculated as: Point1 + mV (measured value) and displayed on the next screen.

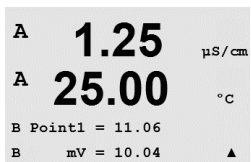

Z is the newly calculated offset calibration factor. The slope calibration factor S is always 1 and does not enter the calculation.

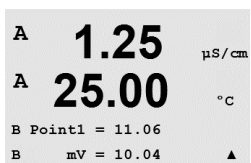

Select Yes to save the new calibration values and the successful Calibration is confirmed on the display.

7.6 Sensor Temperature Calibration

Enter Sensor Calibration mode as described in section 7.1 and select Temperature.

```
A 1.25 µS/cm
A 25.00 °C
Calibrate Sensor
Channel A Temperature ▲
```

7.6.1 One-Point Sensor Temperature Calibration

Select 1 point calibration. Slope or Offset can be selected with the 1 point calibration. Select Slope to recalculate the Slope factor M (Multiplier) or Offset to recalculate the offset calibration factor A (Adder).

```
A 1.25 µS/cm
A 25.00 °C
Temperature Calibration
Type = 1 point Slope ▲
```

Enter the value for Point 1 and press [ENTER].

```
A 1.25 µS/cm
A 25.00 °C
A Point1 = 25.02 °C
A T = 25.00 °C ▲
```

The newly calculated value – either M or A – is displayed. Select Yes to save the new calibration values and the successful Calibration is confirmed on the display.

```
A 1.25 µS/cm
A 25.00 °C
Temp M=1.00001 A=0.00000
Save Calibration Yes ▲
```

7.6.2 Two – Point Sensor Temperature Calibration

Select 2 point as calibration Type.

```
A 1.25 µS/cm
A 25.00 °C
Temperature Calibration
Type = 2 point ▲
```

Enter the value for Point 1 and press [ENTER].

```
A 1.25 µS/cm
A 25.00 °C
A Point1 = 25.02 °C
A T = 25.00 °C ▲
```

Enter the value for Point 2 and press [ENTER].

```
A 1.25 µS/cm
A 25.00 °C
A Point2 = 50.00 °C
A T = 50.64 °C ▲
```

The newly calculated values M and A are displayed. Select Yes and press [ENTER] to save the new calibration values and the successful Calibration is confirmed on the display.

```
A 1.25 µS/cm
A 25.00 °C
Temp M=1.00001 A=0.00000
Save Calibration Yes ▲
```

7.7 Edit Sensor Calibration Constants

Enter Calibration mode as described in section 7.1 and select Edit, Edit pH or Edit mV.

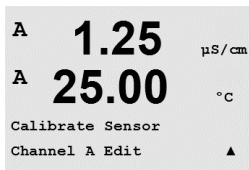

All calibration constants for the selected sensor channel are displayed. Primary measurement constants (p) are displayed on Line 3. Secondary measurement (temperature) constants (s) for the sensor are displayed on Line 4.



The calibration constants can be changed in this menu.

Select Yes to save the new calibration values and the successful Calibration is confirmed on the display.

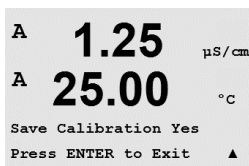

NOTE: Each time a new conductivity sensor is connected to the M300 transmitter, it is necessary to enter the unique calibration constant located on the sensor label.

7.8 Sensor Verification

Enter Calibration mode as described in section 7.1. and select Verify.



The measured signal of the primary and the secondary measurement in electrical units are shown. The meter calibration factors are used when calculating these values.

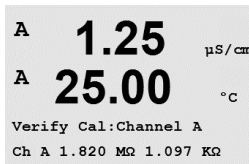

Use the ▲ or ▼ key to toggle between Channel A and B

8 Configuration

(PATH: Menu/Configure)

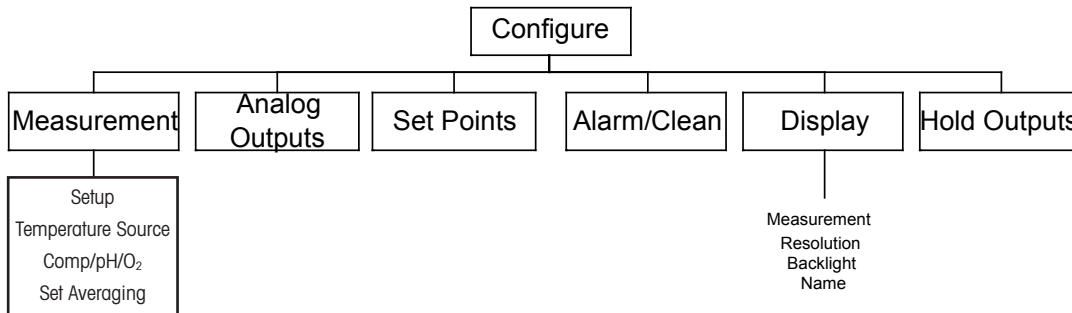

8.1 Enter Configuration Mode



While in Measurement mode, press the ◀ key. Press the ▲ or ▼ key to navigate to the Configure – Menu and press [ENTER].

8.2 Measurement

(PATH: Menu/Configure/Measurement)

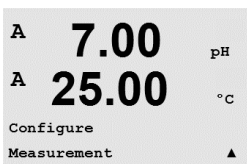

Enter configuration mode as described in Section 8.1.

Press the [ENTER] key to select this Menu. The following sub menus can now be selected: Channel Setup, Temperature Source, Comp/pH/O₂ and Set Averaging.

8.2.1 Channel Setup

Press the [ENTER] key to select the 'Channel Setup' Menu.

```

A  7.00  pH
A  25.00  °C
Measurement Setup
Channel Setup ▲
  
```

Select Sensor Type and press [ENTER].

Available Sensor Types are:

Cond(2) = 2 electrode conductivity

Cond(4) = 4 electrode conductivity

O₂(l) = Dissolved Oxygen (except 58037221)

O₂(V) = Dissolved Oxygen 58037221 (Thornton models only)

O₃ = Dissolved Ozone (Thornton models only)

pH/ORP = pH or ORP

```

A  7.00  pH
A  25.00  °C
A Sensor Type = pH/ORP
B Sensor Type = Cond(2) ▲
  
```

The 4 lines of the display can now be configured with sensor channel 'A' or 'B' for each line of the display as well as measurements and unit multipliers. Pressing the [ENTER] key will display the selection for lines c and d.

```

A  7.00  pH
A  25.00  °C
aA pH ( )
bA °C ( ) ▲
  
```

Pressing the [ENTER] key again will bring up the Save Changes dialog. Selecting No will discard the entered values and return to the measurement display screen, selecting Yes will save changes made.

```

A  7.00  pH
A  25.00  °C
Save Changes Yes & Exit
Press ENTER to Exit ▲
  
```

8.2.2 Derived Measurements (Thornton models only)

There are three derived measurements available for configuration with two Conductivity sensors: %Rej (% Rejection), pH Cal (Calculated pH) and CO₂ Cal (Calculated CO₂). To set up any of the derived measurements, first set up the two primary conductivity measurements, which will be used to calculate the derived measurement. Define the primary measurements as if they were stand-alone readings. Then the derived measurement can be defined.

NOTE: It is important to use the same units for both measurements.



8.2.2.1 % Rejection measurement

For reverse osmosis (RO) applications, percent rejection is measured with conductivity to determine the ratio of impurities removed from product or permeate water to the total impurities in the incoming feed water. The formula for obtaining Percent Rejection is:

$$[1 - (\text{Product/Feed})] \times 100 = \% \text{ Rejection}$$

Where Product and Feed are the conductivity values measured by the respective sensors.

Figure 4.1 shows a diagram of an RO installation with sensors installed for Percent Rejection.

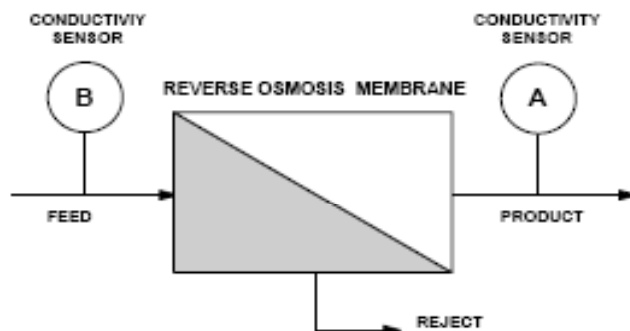

Figure 4.1: % Rejection



NOTE: The product monitoring sensor must be on the channel that will measure percent rejection. If the product conductivity sensor is installed in channel A, then percent rejection must be measured in channel A.

8.2.2.2 Calculated pH (Power plant applications only)

Calculated pH may be obtained very accurately from specific and cation conductivity values on power plant samples when the pH is between 7.5 and 10.5 due to ammonia or amines and when the specific conductivity is significantly greater than the cation conductivity. This calculation is not suitable where significant levels of phosphates are present. The M300 uses this algorithm when pH CAL is selected as a measurement.

The calculated pH must be configured on the same channel as specific conductivity. For example, set up measurement 'a' on channel A to be specific conductivity, measurement 'b' on Channel B to be cation conductivity, measurement 'c' on channel A to be calculated pH and measurement 'd' on channel A to be temperature. Set the temperature compensation mode to "Ammonia" for measurement 'a' and to "Cation" for measurement 'b'.



NOTE: If operation goes outside the recommended conditions, a glass electrode pH measurement is needed to obtain an accurate value. On the other hand, when sample conditions are within the ranges noted above, the calculated pH provides an accurate standard for one-point trim calibration of the electrode pH measurement.

8.2.2.3 Calculated CO₂ (Power plant applications only)

Carbon dioxide may be calculated from cation conductivity and degassed cation conductivity measurements on power plant samples using tables from ASTM Standard D4519. The M300 has these tables stored in memory, which it uses when units of CO₂ CAL are selected.

The calculated CO₂ measurement must be configured to the same channel as cation conductivity. For example, set up measurement 'a' on channel A to be cation conductivity, measurement 'b' on channel B to be degassed cation conductivity, measurement 'c' on channel A to be calculated CO₂ and measurement 'd' on channel B to be temperature. Set the temperature compensation mode to "Cation" for both conductivity measurements.

8.2.3 Temperature Source



Press the [ENTER] key to select this Menu. The following options can be chosen:
‘Fixed’: allows a specific temperature value to be entered.

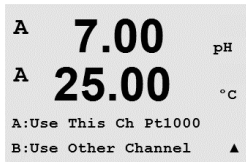

‘Use this Ch PT1000’: temperature input will be taken from the sensor attached.

‘Use this Ch PT100’: temperature input will be taken from sensor attached

‘Use Other Channel’: temperature input will be taken from the sensor attached to the other channel

8.2.4 Comp/pH/O₂

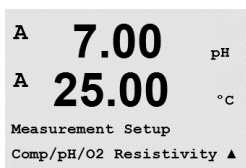

Press [ENTER] to select this Menu. Additional measurement and calibration parameters can be set for each parameter; conductivity, pH and O₂.

8.2.4.1 Conductivity/Resistivity Temperature Compensation



NOTE: Temperature Compensation selection is available on Thornton model transmitters only. All other models use only Standard Compensation.

Select Resistivity and press [ENTER].

```
A 7.00 pH
A 25.00 °C
Measurement Setup
Comp/pH/O2 Resistivity ▲
```

```
A 7.00 pH
A 25.00 °C
a Compensation=Standard
b Compensation=Linear ▲
```

```
A 7.00 pH
A 25.00 °C
c Compensation=Cation
d Compensation=Std 75°C▲
```

The temperature compensation mode for any of the four measurement lines can be selected. Temperature compensation should be matched to the characteristics of the application. Choices are 'None', 'Standard', 'Light 84', 'Std 75°C', 'Linear', 'Glycol.5', 'Glycol1', 'Cation', 'Alcohol', and 'Ammonia'. Press [ENTER] and save changes.

Standard compensation includes compensation for non-linear high purity effects as well as conventional neutral salt impurities and conforms to ASTM standards D1125 and D5391.

Std 75°C compensation is the Standard compensation algorithm referenced to 75°C. This compensation may be preferred when measuring Ultrapure Water at an elevated temperature. (Resistivity of ultrapure water compensated to 75°C is 2.4818 Mohm-cm.)

Linear compensation adjusts the reading by a factor expressed as a "% per °C" (deviation from 25°C). Use only if the sample has a well-characterized linear temperature coefficient. The factory default setting is 2.0%/°C.

Glycol.5 compensation matches the temperature characteristics of 50% ethylene glycol in water. Compensated measurements using this solution may go above 18 Mohm-cm.

Glycol1 compensation matches the temperature characteristics of 100% ethylene glycol. Compensated measurements may go well above 18 Mohm-cm.

Cation compensation is used in power industry applications measuring the sample after a cation exchanger. It takes into account the effects of temperature on the dissociation of pure water in the presence of acids.

Alcohol compensation provides for the temperature characteristics of a 75% solution of isopropyl alcohol in pure water. Compensated measurements using this solution may go above 18 Mohm-cm.

Light 84 compensation matches the high purity water research results of Dr. T.S. Light published in 1984. Use only if your institution has standardized on that work.

Ammonia compensation is used in power industry applications for specific conductivity measured on samples using ammonia and/or ETA (ethanolamine) water treatment. It takes into account the effects of temperature on the dissociation of pure water in the presence of these bases.

8.2.4.2 pH Parameters

```

A  7.00  pH
A  25.00 °C
Measurement Setup
Comp/pH/02 pH ▲

```

Select pH and press [ENTER].

```

A  7.00  pH
A  25.00 °C
A:IP = 7.000 pH
B:IP = 7.000 pH ▲

```

Select the Drift control for calibration as Auto (drift and time criteria have to be fulfilled) or Manual (The user can decide when a signal is stable enough to complete calibration) followed by the relevant buffer table for the automatic buffer recognition. If the drift rate is less than 0.4 mV over a 20 second interval then the reading is stable and the calibration is done using the last reading. If the drift criteria is not met within 300 seconds then the calibration times out and the message "Calibration Unsuccessful Press Enter to Continue" is displayed.

```

A  7.00  pH
A  25.00 °C
A:pH Buffer= Mettler-9
B:pH Buffer= Mettler-10▲

```

For automatic buffer recognition during calibration, select the buffer solution set that will be used: Mettler-9, Mettler-10, NIST Tech, NIST Std, HACH, CIBA, MERCK, WTW or None. See Section 20 for buffer values. If the auto buffer feature will not be used or if the available buffers are different from those above, select None.

```

A  7.00  pH
A  25.00 °C
A:Drift Control = Auto
B:Drift Control =Manual▲

```

STC is the solution temperature coefficient in units of pH/°C referenced to 25 °C (Default = 0.000 for most applications). For pure waters, a setting of 0.016 pH/°C should be used. For low conductivity power plant samples near 9 pH, a setting of 0.033 pH/°C should be used. These positive coefficients compensate for the negative temperature influence on the pH of these samples.

IP is the isothermal point value (Default = 7.000)

```

A  7.00  pH
A  25.00 °C
A:Fix CalTemp No
B:Fix CalTemp Yes 25.00▲

```

The option to enter a fixed Calibration Temperature is given. 'Fixed' allows a specific temperature value to be entered. Selecting 'No' means the Temperature configured under 8.2.2 will be used for the Calibration.

```

A  7.00  pH
A  25.00 °C
A:STC = 0.000 pH/°C
B:STC = 0.000 pH/°C ▲

```

Pressing [ENTER] again will bring up the Save Changes dialog. Selecting No will discard the entered values and return to the measurement display screen, selecting Yes will save changes made.

8.2.4.3 Dissolved Oxygen Parameters

Select O₂ and press [ENTER]

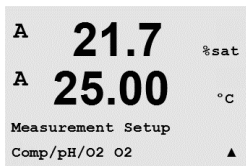

Enter the Atmospheric pressure. The default value for AtmPres is 760.0 and the default unit is mmHg.



Enter the Process Pressure. The units for ProcPres and AtmPres do not have to be the same.



The salinity of the measured solution and the relative humidity of the calibration gas can also be entered. The allowed values for Relative Humidity are in the range 0.00 to 1.00.

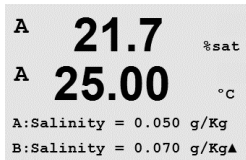

Pressing the [ENTER] key again will bring up the Save Changes dialog. Selecting No will discard the entered values and return to the measurement display screen, selecting Yes will save changes made.

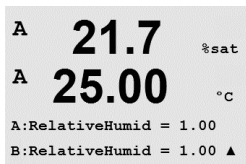

8.2.5 Set Averaging

Press the [ENTER] key to select this Menu. The averaging method (noise filter) for each measurement line can now be selected. The options are Special (Default), None, Low, Medium and High:

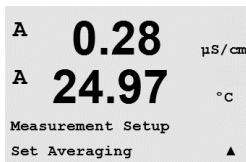

None = no averaging or filtering

Low = equivalent to a 3 point moving average

Medium = equivalent to a 6 point moving average

High = equivalent to a 10 point moving average

Special = averaging depending on signal change (normally High averaging but Low averaging for large changes in input signal)



Pressing the [ENTER] key again will bring up the Save Changes dialog. Selecting No will discard the entered values and return to the measurement display screen, selecting Yes will save changes made.

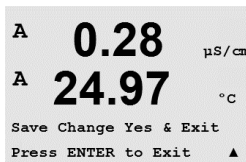

8.3 Analog Outputs

(PATH: Menu/Configure/Analog Outputs)

Enter configuration mode as described in Section 8.2.

Press the [ENTER] key to select this Menu, which lets you configure the 4 Analog Outputs. Once analog outputs have been selected, use the ◀ and ▶ buttons to navigate between configurable parameters. Once a parameter is selected, its setting can be selected per the following table:

When an Alarm Value is selected, the analog output will go to this value if any alarm condition occurs.

Parameter	Selectable Values
Aout:	1, 2, 3 or 4 (default is 1)
Measurement:	a, b, c, d or blank (none) (default is blank)
Alarm Value:	3.6 mA, 22.0 mA or Off (default is off)

The Aout type can be Normal, Bi-Linear, Auto-Range or Logarithmic. The range can be 4–20mA or 0–20mA. Normal provides linear scaling between the minimum and maximum scaling limits and is the default setting. Bi-Linear will also prompt for a scaling value for the mid-point of the signal and allows two different linear segments between the minimum and maximum scaling limits.

Enter the minimum and maximum Value of Aout.

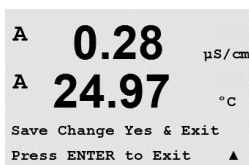
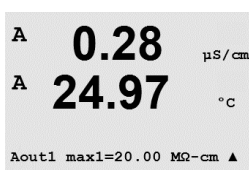
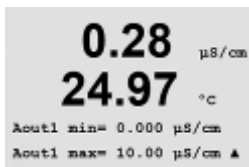
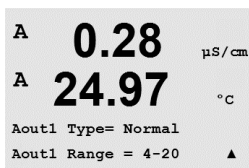
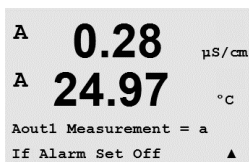
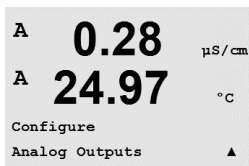

If Auto-range was selected then Aout max1 can be configured. Aout max1 is the maximum value for the first range on Auto-Range. The maximum value for the second range on Auto-Range was set in the previous menu. If Logarithmic Range was selected, it will also prompt for the number of decades as 'Aout1 # of Decades =2'.

The value for the Hold mode can be configured to hold the Last value or can be set to a Fixed value.

Pressing the [ENTER] key again will bring up the Save Changes dialog. Selecting No will discard the entered values and return to the measurement display screen, selecting Yes will save changes made.

8.4 Setpoints

(PATH: Menu/Configure/Setpoints)

Enter configuration mode as described in Section 8.2.

Press the [ENTER] key to select this Menu.

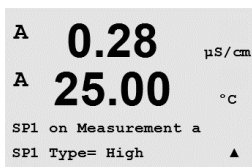
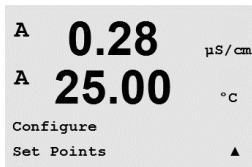

Up to 6 Setpoints can be configured on any of the measurements (a thru d). The possible Setpoint types are Off, High, Low, Outside and Between. Thornton models also include types, %USP, %EP PW and %EP WFI for configuration with conductivity sensors.

An 'Outside' Setpoint will cause an alarm condition whenever the measurement goes above its high limit or below its low limit. A 'Between' Setpoint will cause an alarm condition to occur whenever the measurement is between its high and low limits.

USP and EP Setpoints on Thornton models provide a high alarm used for pharmaceutical water monitoring with non-temperature compensated conductivity measurements. USP (United States Pharmacopoeia) section <645> and European Pharmacopoeia require that non-temperature compensated conductivity of pharmaceutical waters must be below a limit from tables based on the temperature of the sample. In other words, pharmaceutical requirements temperature-compensate the limit rather than the measurement.

The Mettler Toledo Thornton M300 has these pharmaceutical limit tables in memory and automatically determines the conductivity limit based on the measured temperature. USP and EPWFI (Water for Injection) setpoints use Table 8.1. The limit is the conductivity value corresponding to the 5° temperature step immediately below or equal to the measured temperature value. EP *Highly* Purified Water limits are identical to EP WFI limits. EP PW (Purified Water) setpoints use Table 8.2. The limit in this case is the conductivity value interpolated for the measured temperature. The M300 takes care of this automatically.

The pharmaceutical setpoint value entered into the M300 is the percentage safety margin *below* the limits to activate the setpoint. For example, the USP table conductivity limit at 15°C is 1.0 μS/cm. If the setpoint value is set at 40% then the setpoint will activate whenever the conductivity goes above 0.6 μS/cm at 15°C.

Table 8.1: USP Section <645> Stage 1, EP WFI (Water for Injection), and EP Highly Purified Water Conductivity Limits as a Function of Temperature

Temperature (°C)	Conductivity Limit (µS/cm)
0	0.6
5	0.8
10	0.9
15	1.0
20	1.1
25	1.3
30	1.4
35	1.5
40	1.7
45	1.8
50	1.9
55	2.1
60	2.2
65	2.4
70	2.5
75	2.7
80	2.7
85	2.7
90	2.7
95	2.9
100	3.1

Table 8.2: EP PW (Purified Water) Conductivity Limits as a Function of Temperature

Temperature (°C)	Conductivity Limit (µS/cm)
0	2.4
10	3.6
20	4.3
25	5.1
30	5.4
40	6.5
50	7.1
60	8.1
70	9.1
75	9.7
80	9.7
90	9.7
100	10.2



Enter the desired value(s) for the Setpoint and press [ENTER]

This screen provides the option to configure a setpoint to be active on an over range condition. Select the setpoint and 'Yes' or 'No'. Select the desired relay that will activate when the setpoint alarm condition is reached.



Over Range

Once configured, the selected relay will be activated if a sensor over-range condition is detected on the assigned input channel.

Delay

Enter the delay time in seconds. A time delay requires the setpoint to be exceeded continuously for the specified length of time before activating the relay. If the condition disappears before the delay period is over, the relay will not be activated.

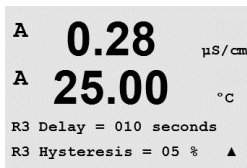

Hysteresis

Enter the hysteresis as a percentage-value. A hysteresis value requires the measurement to return within the setpoint value by a specified percentage before the relay is deactivated.

For a high setpoint, the measurement must decrease more than the indicated percentage below the setpoint value before the relay is deactivated. With a low setpoint, the measurement must rise at least this percentage above the setpoint value before the relay is deactivated. For example, with a high setpoint of 100, when this value is exceeded, the measurement must fall below 90 before the relay is deactivated.



Hold

Enter the Relay Hold Status of 'Last' or 'Off'. This is the state the Relay will go to during a Hold status.

State

Relay contacts are in normal state until the associated setpoint is exceeded, then the relay is activated and the contact states change.

Select 'Inverted' to reverse the normal operating state of the relay (i.e. Normally open contacts are in a closed state, and normally closed contacts are in an open state, until the setpoint is exceeded). 'Inverted' relay operation is functional when power is applied to the M300 transmitter.

Pressing the [ENTER] key again will bring up the Save Changes dialog. Selecting No will discard the entered values and return to the measurement display screen, selecting Yes will save changes made.

8.5 Alarm/Clean

(PATH: Menu/Configure/Alarm/Clean)

Enter configuration mode as described in Section 8.1.

This Menu allows the configuration of Alarm and Clean functionality.



8.5.1 Alarm

To select 'Setup Alarm', press the ▲ or ▼ key so that 'Alarm' is flashing.

Using the ◀ and ▶ buttons, navigate to "Use Relay #". Using the ▲ or ▼ keys, select a relay to be used for the Alarm and press [ENTER].

One of the following events may be alarmed:

1. Power Failure
2. Software Failure
3. Rg Diagnostics – pH glass membrane resistance
4. Rr Diagnostics – pH reference resistance

If any of these are set to Yes, an alarm signal will be initiated, the selected relay will be activated, and an alarm message will be recorded if:

1. there is a power failure or power cycling
2. the software watchdog performs a reset
3. Rg is out of tolerance – for example, broken measuring electrode
4. Rr is out of tolerance – for example, coated or depleted reference electrode

For 1 and 2 the alarm indicator will be turned off when the alarm message is cleared. It will reappear if the power is constantly cycling or if the watchdog is repeatedly resetting the system.

For 3 and 4 the alarm indicator will go off if the message is cleared and the sensor has been replaced or repaired so that the Rg and Rr values are within specification. If the Rg or Rr message is cleared and Rg or Rr is still out of tolerance then the alarm will stay on and the message will reappear. The Rg and Rr alarm can be turned off by going into this menu and setting Rg Diagnostics and/or Rr Diagnostics to No. The message can then be cleared and the alarm indicator will be off even though Rg or Rr is out of tolerance.

Each Alarm Relay can be configured in either a Normal or Inverted state. In addition, a Delay for the activation can be set. For more information, refer to Section 8.4.

Pressing the [ENTER] key again will bring up the Save Changes dialog. Selecting No will discard the entered values, selecting Yes will make the entered values the current ones.



8.5.2 Clean

Configure the Relay to be used for the cleaning cycle.
The Default value is Relay 1.

```
A 0.28  μS/cm
A 25.00 °C
Setup Clean
Use Relay # 1 ▲
```

The Cleaning Interval can be set from 0.000 to 999.9 hours. Setting it to 0 turns the clean cycle off. The cleaning time can be 0 to 9999 seconds and must be smaller than the Cleaning Interval.

```
A 0.28  μS/cm
A 25.00 °C
CleanInterval= 0.000 hrs
Clean Time = 0000 sec ▲
```

Select the desired Relay state: Normal or Inverted.

Pressing the [ENTER] key again will bring up the Save Changes dialog. Selecting No will discard the entered values and return to the measurement display screen, selecting Yes will save changes made.

```
A 0.28  μS/cm
A 25.00 °C
Relay State = Normal ▲
```

8.6 Display

(PATH: Menu/Configure/Display)

Enter configuration mode as described in Section 8.2.

This Menu allows for the configuration of the values to be displayed and also the configuration of the Display itself.

```
A 0.28  μS/cm
A 25.00 °C
Configure
Display ▲
```

8.6.1 Measurement

The Display has 4 lines. Line 1 on top and Line 4 on the bottom.

Select the values (Measurement a, b, c or d) to be displayed on each line of the display.

```
A 0.28  μS/cm
A 25.00 °C
Display Setup
Measurement ▲
```

Select the 'Error Display' mode. If this is set to 'On' when an alarm has occurred, the message "Failure – Press Enter" will be displayed on Line 4 when an alarm occurs in the normal Measurement mode.

```
A 0.28  μS/cm
A 25.00 °C
Line 1 = a Line 2 = b
Line 3 = c Line 4 = d ▲
```

Pressing the [ENTER] key again will bring up the Save Changes dialog. Selecting No will discard the entered values, selecting Yes will make the entered values the current ones.

```
A 0.28  μS/cm
A 25.00 °C
Error Display Off ▲
```

8.6.2 Resolution

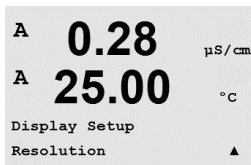

This menu allows the setting of the resolution of each displayed value.

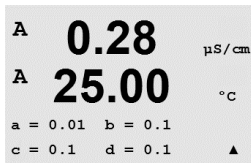

Possible settings are 1, 0.1, 0.01, 0.001 or Auto.

Pressing the [ENTER] key will bring up the Save Changes dialog.

8.6.3 Backlight

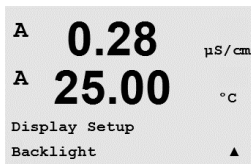

This Menu allows the setting of the back light options of the display.



Possible settings are On, On 50% or Auto Off 50%. If Auto Off 50% is selected then the backlight will go to 50% after 4 minutes with no keypad activity. The backlight will automatically come back on if a key is pressed.

Pressing the [ENTER] key Will bring up the Save Changes dialog.

8.6.4 Name

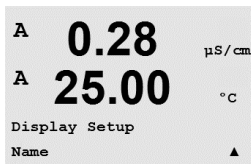

This menu allows for the configuration of an alpha-numeric name which is displayed in the first 9 characters on Lines 3 and 4 of the Display. The default is nothing (blank).

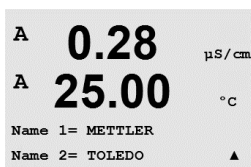

Use the ◀ and ▶ keys to navigate between digits to be altered. Using the ▲ and ▼ keys to change the character to be displayed. Once all digits of both display channels have been entered, press [ENTER] to bring up the Save Changes dialog.



The resulting display in the measurement mode appears on Lines 3 and 4 ahead of the measurements.

8.7 Hold Analog Outputs

(PATH: Menu/Configure/Hold Outputs)

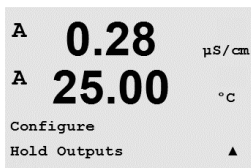

Enter configuration mode as described in Section [8.1](#).

The Digital Input used to remotely control the Hold function is configured with this Menu. Initiating a Hold condition will maintain the analog output signal and relay status at the value/state at the time the Hold is initiated, for as long as the Hold state is maintained. In addition, the USB output will be held if the USB Hold option is set to "Last Values". The USB Hold feature is set to "Off" by default. Refer to section 9.2 for more information on the USB settings.

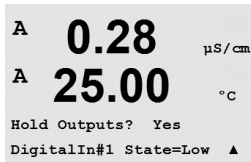

Analog output and relay status will not be held if 'No' is selected. If 'Yes' is selected, Outputs will be held depending on the status of the selected Digital Input. Digital Input choices are 'High', 'Low' or 'Off'. All analog outputs and relay status will be held if the Digital Input is in the selected state. If 'Off' is selected as Digital Input status, the Digital Input is inactive and the Hold status will not be triggered through an external signal, although the outputs will be held during configuration or calibration procedures as long as the Hold Outputs option is 'Yes'.

9 System

(PATH: Menu/System)

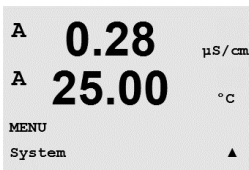
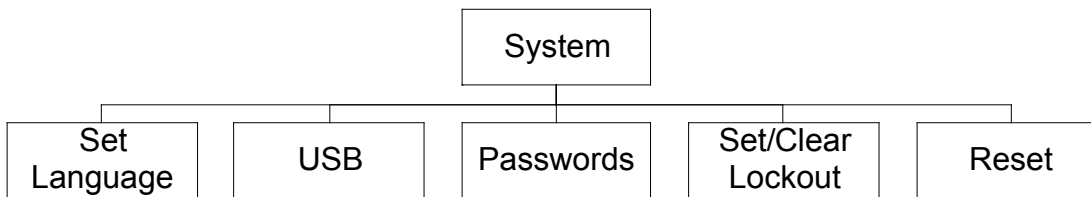

While in Measurement mode press the ◀ key. Press the ▼ or ▲ key to navigate to 'System' – Menu and press [ENTER].

9.1 Set Language

(PATH: Menu/System/Set Language)

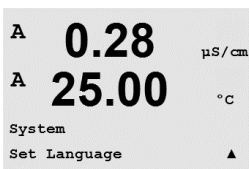

This Menu allows the configuration of the Display language.

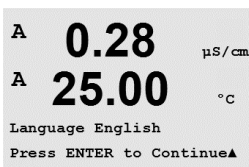

The following selections are possible: English, French, German, Italian and Spanish. Pressing the [ENTER] key will bring up the Save Changes dialog.

9.2 USB

(PATH: Menu/System/USB)

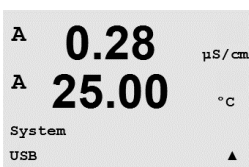

This menu allows configuration of the USB hold function.

USB Hold may be set to either Off or Last Values. An external host device may poll the M300 for data. If the USB Hold is set to Off, current values are returned. If the USB Hold is set to Last Values, the values present at the time the hold condition was established are returned.

Details of USB functions and communication protocols are covered in separate documentation.



Press [ENTER] to bring up the Save Changes dialog.

9.3 Passwords

(PATH: Menu/System/Passwords)

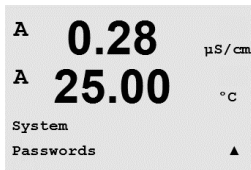

This Menu allows for the configuration of Operator and Administrator Passwords, as well as setting up a List of allowed Menus for the Operator. The Administrator has rights to access all Menus. All default passwords for new transmitters are '00000'.

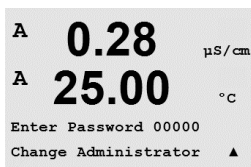

The Passwords Menu is protected: Enter the Administrator Password to enter the Menu.

9.3.1 Changing Passwords

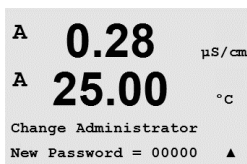

See Section 9.3 on how to enter the Passwords Menu. Select Change Administrator or Change Operator and set the new Password.

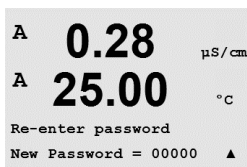

Press the [ENTER] key and confirm the new password. Press [ENTER] again to bring up the Save Changed dialog.

9.3.2 Configuring Menu Access for Operator

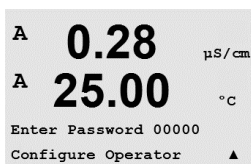

See 9.3 on how to enter the Passwords Menu. Select Configure Operator to configure the Access list for the Operator. It is possible to assign/deny rights to the following Menus: Cal Key, Quick Setup, Configuration, System, PID Setup and Service.

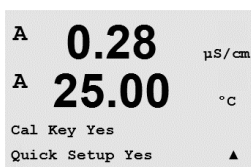

Choose either Yes or No to give/deny access to the above Menus and press [ENTER] to advance to the next items. Pressing the [ENTER] key after configuring all menus will bring up the Save Changes dialog. Selecting No will discard the entered values, selecting Yes will make the entered values the current ones.

9.4 Set/Clear Lockout

(PATH: Menu/System/Set/Clear Lockout)

This menu enables/disables the Lockout functionality of the transmitter. The user will be asked for a password before being allowed into any menus if the Lockout functionality is enabled.

```

A 0.28  μS/cm
A 25.00 °C
System
Set/Clear Lockout ▲
  
```

```

A 0.28  μS/cm
A 25.00 °C
Password = 00000
Enable Lockout = Yes ▲
  
```

The Lockout – Menu is protected: Enter the Administrator Password and select YES to enable or NO to disable the Lockout functionality. Pressing the [ENTER] key after the selection will bring up the Save Changes dialog. Selecting No will discard the entered value, selecting Yes will make the entered value the current one.

9.5 Reset

(PATH: Menu/System/Reset)

This Menu allows access to the following options:
Reset System, Reset Meter Cal, Reset Analog Cal.

```

A 0.28  μS/cm
A 25.00 °C
System
Reset ▲
  
```

9.5.1 Reset System

This Menu allows the reset of the meter to the factory default settings (Setpoints off, analog outputs off, etc.). The meter calibration and the analog output calibration are not affected.

```

A 0.28  μS/cm
A 25.00 °C
Reset System ? Yes
Press ENTER to Continue▲
  
```

```

A 0.28  μS/cm
A 25.00 °C
Reset System
Are you sure? Yes ▲
  
```

Pressing the [ENTER] key after the selection will bring up a confirmation screen. Selecting No will return the user to the Measurement mode with no changes. Selecting Yes will reset the meter.

9.5.2 Reset Meter Calibration

This Menu allows the reset of the meter's calibration factors to the last factory calibration values.

```

A 0.28  μS/cm
A 25.00 °C
Reset Meter Cal ? Yes
Press ENTER to Continue▲
  
```

```

A 0.28  μS/cm
A 25.00 °C
Reset Meter Calibration
Are you sure? Yes ▲
  
```

Pressing the [ENTER] key after the selection will bring up a confirmation screen. Selecting No will return the user to the Measurement mode with no changes. Selecting Yes will reset the meter calibration factors.

9.5.3 Reset Analog Calibration

```
A 0.28 µS/cm
A 25.00 °C
Reset Analog Cal? Yes
Press ENTER to Continue▲
```

This Menu allows reset of the Analog Output calibration factors to the last factory calibration values.

```
A 0.28 µS/cm
A 25.00 °C
Reset Analog Calibration
Are you sure? Yes ▲
```

Pressing the [ENTER] key after the selection will bring up a confirmation screen. Selecting No will return the user to the Measurement mode with no changes. Selecting Yes will reset the Analog Output calibration.

10 PID Setup

(PATH: Menu/PID Setup)

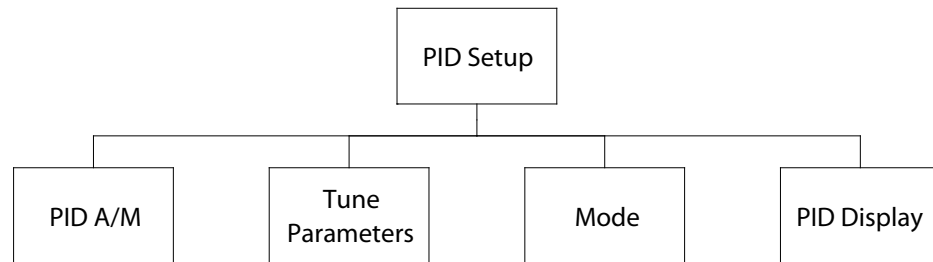

PID control is proportional, integral and derivative control action that can provide smooth regulation of a process. Before configuring the transmitter, the following process characteristics must be identified.

Identify the **control direction** of the process

– **Conductivity:**

Dilution – direct acting where increasing measurement produces increasing control output such as controlling the feed of low conductivity diluting water to rinse tanks, cooling towers or boilers

Concentrating – reverse acting where increasing measurement produces decreasing control output, such as controlling chemical feed to attain a desired concentration

– **Dissolved Oxygen:**

Deaeration – direct acting where increasing DO concentration produces increasing control output such as controlling the feed of a reducing agent to remove oxygen from boiler feedwater

Aeration – reverse acting where increasing DO concentration produces decreasing control output, such as controlling an aerator blower speed to maintain a desired DO concentration in fermentation or wastewater treatment

– **pH/ORP:**

Acid feed only – direct acting where increasing pH produces increasing control output, also for ORP reducing reagent feed

Base feed only – reverse acting where increasing pH produces decreasing control output, also for ORP oxidizing reagent feed

Both acid and base feed – direct and reverse acting

– **Ozone:**

Ozone destruct – direct acting where increasing ozone concentration produces increasing control output such as increasing UV lamp intensity

Ozonation – reverse acting where increasing ozone concentration produces a decreasing control output to decrease the output of an ozonator.

Identify the **control output type** based on the control device to be used:

Pulse Frequency – used with pulse input metering pump

Pulse Length – used with solenoid valve

Analog – used with current input device such as electric drive unit, analog input metering pump or current-to-pneumatic (I/P) converter for pneumatic control valve

Default control settings provide linear control, which is appropriate for conductivity, dissolved oxygen and ozone. Therefore, when configuring PID for these parameters (or simple pH control) ignore settings of deadband and corner points in the Tuning Parameter section below. The non-linear control settings are used for more difficult pH/ORP control situations.

If desired, identify the non-linearity of the pH/ORP process. Improved control can be obtained if the non-linearity is accommodated with an opposing non-linearity in the controller. A titration curve (graph of pH or ORP vs. reagent volume) made on a process sample provides the best information. There is often a very high process gain or sensitivity near the setpoint and decreasing gain further away from the setpoint. To counteract this, the instrument allows for adjustable non-linear control with settings of a deadband around the setpoint, corner points further out and proportional limits at the ends of control as shown in the figure below. Determine the appropriate settings for each of these control parameters based on the shape of the pH process titration curve.

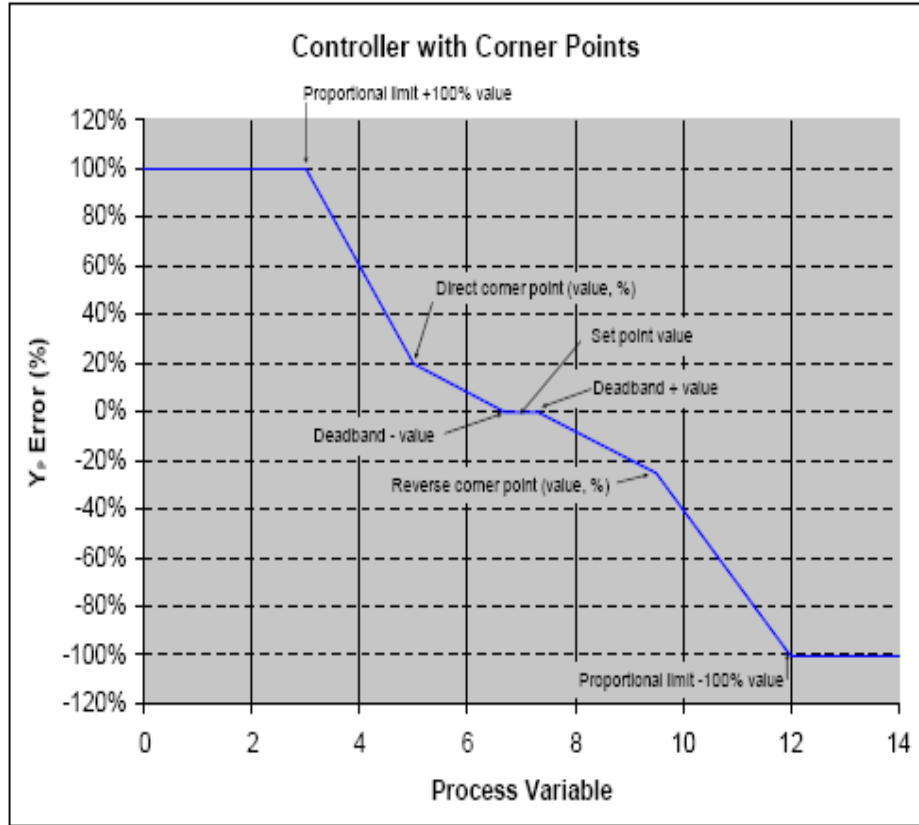

10.1 Enter PID Setup

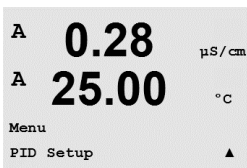

While in Measurement mode press the ◀ key. Press the ▲ or ▼ key to navigate to the PID Setup – Menu and press [ENTER].

10.2 PID Auto/Manual

(PATH: MENU/PID Setup/PID A/M)

This menu allows selection of Automatic or Manual operation. Select Auto or Manual operation. Pressing the [ENTER] key will bring up the Save Changes dialog.

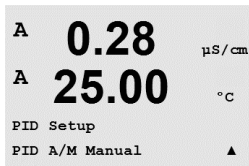

10.3 Mode

(PATH: MENU/PID Setup/Mode)

This menu contains the selection of control modes using relays or analog outputs. Press [ENTER].

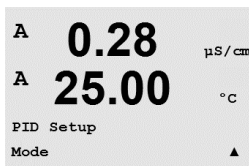

10.3.1 PID Mode

This menu assigns a relay or analog output for PID control action as well as details of their operation. Based on the control device being used, select one of the following three paragraphs for use with solenoid valve, pulse input metering pump or analog control.

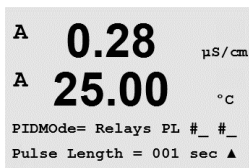

Pulse Length – If using a solenoid valve, select “Relays” and “PL”, Pulse Length. Choose the first relay position as #1 and/or the second relay position as #2 as well as the Pulse Length (PL) according to the table below. A longer pulse length will reduce wear on the solenoid valve. The % “on” time in the cycle is proportional to the control output.

	1 st Relay Position = #1	2 nd Relay Position = #2	Pulse Length (PL)
Conductivity	Controlling concentrating reagent feed	Controlling dilution water	Short (PL) provides more uniform feed. Suggested start point = 30 sec
pH/ORP	Feeding base	Feeding acid	Reagent addition cycle: short PL provides more uniform addition of reagent. Suggested start point = 10 sec
Dissolved Oxygen	Reverse control action	Direct acting control action	Feed cycle time: short PL provides more uniform feed. Suggested start point = 30 sec
Dissolved Ozone	not recommended	not recommended	

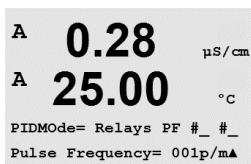

Pulse Frequency – If using a pulse input metering pump, select “Relays” and “PF”, Pulse Frequency. Choose the first relay position as #3 and/or the second relay position as #4 according to the table below. Set the pulse frequency to the maximum frequency allowed for the particular pump being used, typically 60 to 100 pulses/minute. Control action will produce this frequency at 100% output.

CAUTION: Setting the Pulse Frequency too high may cause the pump to overheat.

	1 st Relay Position = #3	2 nd Relay Position = #4	Pulse Frequency (PF)
Conductivity	Controlling concentrating chemical feed	Controlling dilution water	Max allowed for the pump used (typically 60–100 pulses/minute)
pH/ORP	Feeding base	Feeding acid	Max allowed for the pump used (typically 60–100 pulses/minute)
Dissolved Oxygen	Reverse control action	Direct acting control action	Max allowed for the pump used (typically 60–100 pulses/minute)
Dissolved Ozone	not recommended	not recommended	

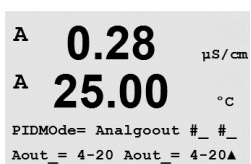

Analog – If using Analog control, change “Relays” to “Analogout” using up/down arrow keys. Choose the first Analogout position as #1 and/or the second Analogout position as #2 according to the table below. Select the analog output current range required by the control device, 4–20 or 0–20 mA. Press [ENTER].

	1 st Analogout Position = #1	2 nd Analogout Position = #2
Conductivity	Controlling concentrating chemical feed	Controlling dilution water
pH/ORP	Feeding base	Feeding acid
Dissolved Oxygen	Reverse control action	Direct acting control action
Dissolved Ozone	Controlling ozonation	Controlling ozone destruction

10.4 Tune Parameters

(PATH: MENU/PID Setup/Tune Parameters)

This menu assigns control to a measurement and sets the setpoint, tuning parameters and non-linear functions of the controller through a series of screens.

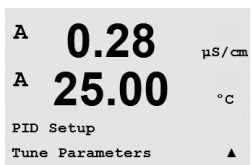

10.4.1 PID Assignment & Tuning

Assign the measurement, a, b, c, or d to be controlled after “PID on_”. Set the Gain (unitless), Integral or Reset time Tr (minutes) and Rate or Derivative time Td (minutes) needed for control. Press [ENTER]. Gain, Reset and Rate are later adjusted by trial and error based on process response. Always begin with Td at zero.

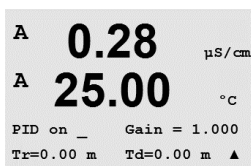

10.4.2 Setpoint & Deadband

```

A 0.28  μS/cm
A 25.00 °C
SetPoint = 0.000 _
Dead Band= +/-0.000 _ ▲

```

Enter the desired setpoint value and the deadband around the setpoint, where no proportional control action will take place. Be sure to include the units multiplier μ or m for conductivity. Press [ENTER].

10.4.3 Proportional Limits

```

A 0.28  μS/cm
A 25.00 °C
Prop Limit Low 0.000 _
Prop Limit High 0.000 _▲

```

Enter the low and high proportional limits – the range over which control action is required. Be sure to include the units multiplier μ or m for conductivity. Press [ENTER].

10.4.4 Corner Points

```

A 0.28  μS/cm
A 25.00 °C
Corner Low 0.000_ 1.000
CornerHigh 0.000_ -1.00▲

```

Enter the low and high corner points in conductivity, pH, dissolved oxygen or dissolved ozone units and the respective output values from -1 to $+1$, shown in the figure as -100 to $+100\%$. Press [ENTER].

10.5 PID Display

(PATH: Menu/PID Setup/PID Display Setup)

This screen enables display of PID control status in the normal measurement mode.

```

A 0.28  μS/cm
A 25.00 °C
PID Setup
PID Display Setup ▲

```

When PID Display is selected, the status (Man or Auto) and control output (%) will be displayed on the bottom line. If controlling pH, the reagent will also be displayed. In addition, for the display to be enabled, a measurement must be assigned under Tune Parameters and a relay or analog output must be assigned under Mode.

```

A 0.28  μS/cm
A 25.00 °C
PID Display Yes ▲

```

In Manual, the control output may be adjusted with the up and down arrow keys. (The "Info" key function is not available in Manual.)

```

A 0.28  μS/cm
A 25.00 °C
B 7.00 pH
Man Ctrl Out 0.0%

```

11 Service

(PATH: Menu/Service)

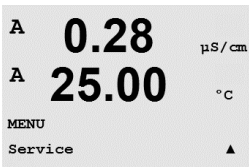
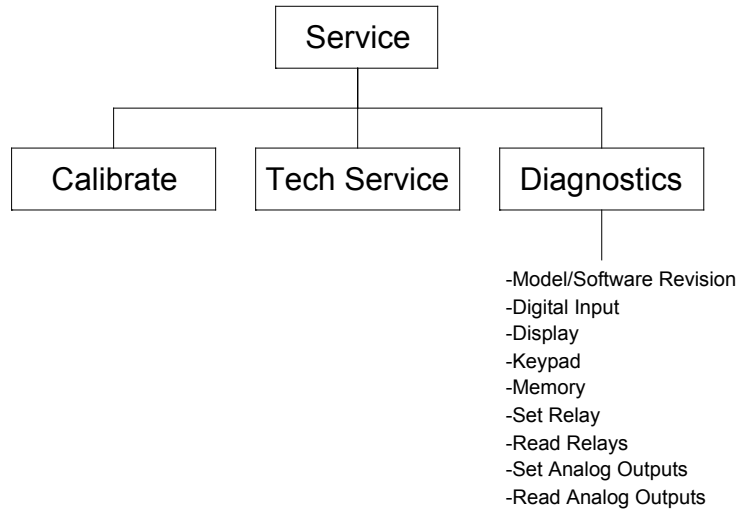

While in Measurement mode press the ◀ key. Press the ▲ or ▼ key to navigate to the 'Service' Menu and press [ENTER]. The available system configuration options are detailed below

11.1 Diagnostics

(PATH: Menu/Service/Diagnostics)

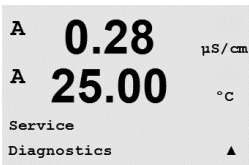

This Menu is a valuable tool for troubleshooting and provides diagnostic functionality for the following items: Model/Software Revision, Digital Input, Display, Keypad, Memory, Set Relays, Read Relays, Set Analog Outputs, Read Analog Outputs.

11.1.1 Model/Software Revision

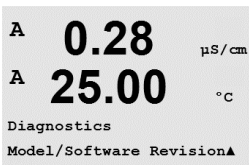

Essential information for every Service call is the model and software revision number. This Menu shows the transmitter part number, serial number and software version number. Press [ENTER] to exit from this display.



11.1.2 Digital Input

The digital Input menu shows the state of the digital inputs. Press [ENTER] to exit from this display.

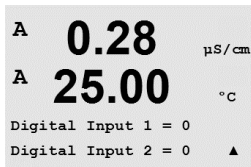
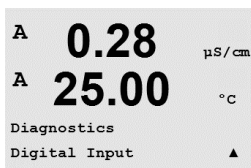

11.1.3 Display

All pixels of the display will be lit for 15 seconds to allow troubleshooting of the display. After 15 seconds the transmitter will return to the normal Measuring mode or press [ENTER] to exit sooner.

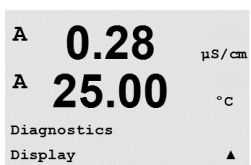

11.1.4 Keypad

For keypad diagnostics, the display will indicate which key is pressed. Pressing [ENTER] will return the transmitter to the normal Measuring mode.

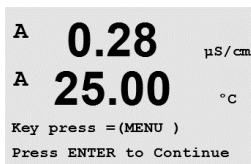
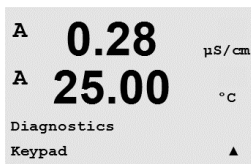

11.1.5 Memory

If Memory is selected then the transmitter will perform a RAM and ROM memory test. Test patterns will be written to and read from all RAM memory locations. The ROM checksum will be recalculated and compared to the value stored in the ROM.

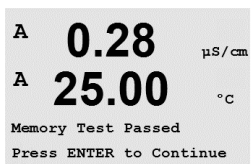
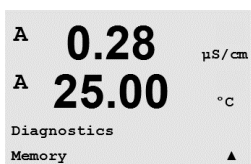

11.1.6 Set Relay

The Set Relays diagnostic menu allows for the activation/deactivation of each Relay. To access relays 5 and 6, press [ENTER].

0 = Normal (normally open contacts are open)
 1 = Inverted (normally open contacts are closed)

Press [ENTER] to return to Measurement mode.

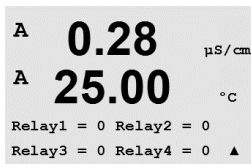
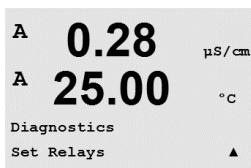

11.1.7 Read Relays

The Read Relays diagnostic menu shows the state of each Relay as defined below. To display Relays 5 and 6, press [ENTER]. Press [ENTER] again to exit from this display.

0 = Normal
 1 = Inverted.

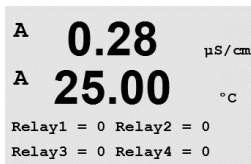
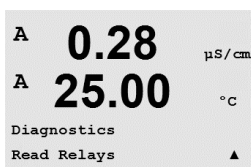

11.1.8 Set Analog Outputs

This menu enables the user to set all analog outputs to any mA value within the 0–22 mA range. Press [ENTER] to exit from this display.

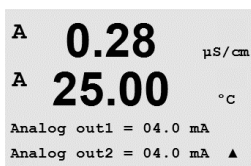
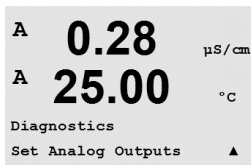

11.1.9 Read Analog Outputs

This menu shows the mA value of the analog Outputs. Press [ENTER] to exit from this display.

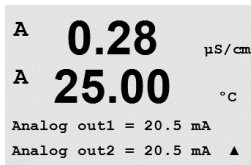
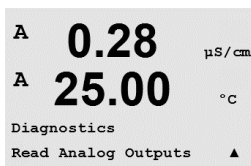

11.2 Calibrate

(PATH: Menu/Service/Calibrate)

This menu has the options to calibrate the transmitter and the analog outputs and also allows the unlocking of calibration functionality.

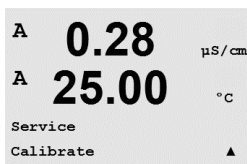

11.2.1 Calibrate Meter

The M300 transmitter is factory calibrated within specifications. It is not normally necessary to perform meter re-calibration unless extreme conditions cause an out of spec operation shown by Calibration Verification. Periodic verification/re-calibration may also be necessary to meet Q.A. requirements. Meter calibration can be selected as Resistance (1–5, used for conductivity), Current (used for most dissolved oxygen and dissolved ozone), Voltage, Rg Diagnostic, Rr Diagnostic (used for pH and 58037221 dissolved oxygen), and Temperature (used for all measurements).

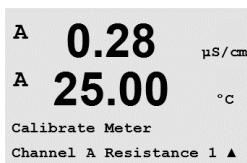

11.2.1.1 Resistance

The meter is equipped with five (5) internal ranges of measurement on each channel. Each resistance range and temperature is calibrated separately, with each resistance range consisting of a two-point calibration.

Below is a table showing the resistance values for all calibration ranges.

Range:	Point 1	Point 2	Point 3
Resistivity 1	1.0 Mohms	10.0 Mohms	–
Resistivity 2	100.0 Kohms	1.0 Mohms	–
Resistivity 3	10.0 Kohms	100.0 Kohms	–
Resistivity 4	1.0 Kohms	10.0 Kohms	–
Resistivity 5	100 Ohms	1.0 Kohms	–
Temperature	1000 Ohms	3.0 Kohms	66 Kohms

It is recommended that both calibration and verification be performed using the M300 Calibrator Module Accessory (refer to accessory list, in section 15). Instructions on the use of this accessory are provided with the calibrator module.

```

A 0.28 μS/cm
A 25.00 °C
Calibrate Meter
Channel A Resistance 1 ▲

```

Navigate to the Calibrate Meter screen and select Channel A or B, and Resistance 1, designating that the transmitter is ready to calibrate the first range resistor. This resistance may be changed, selecting range 1 thru 5. Each resistance range consists of a two-point calibration.

Press [ENTER] to begin the calibration process.

```

A 0.28 μS/cm
A 25.00 °C
A Point1 = 1.0000 MΩ
A R1 = 0.0000 Ω ▲

```

The first text line will ask for the Point 1 resistance value (this will correspond to Resistance 1 value shown on the Calibration Module Accessory). The second text line will show the measured resistance value. When the value stabilizes, press [ENTER] to perform calibration.

The transmitter screen will then prompt the user to enter the value for Point 2, and R1 will display the measured resistance value. When this value stabilizes, press [ENTER] to calibrate this range and bring up a confirmation screen.

Select Yes to save the calibration values and the successful Calibration is confirmed on the display. The transmitter will return to the Measurement mode in approximately 5 seconds.

```

A 0.28 μS/cm
A 25.00 °C
A Point2 = 10.0000 MΩ
A R1 = 0.0000 Ω ▲

```

```

A 0.28 μS/cm
A 25.00 °C
Save Calibration Yes
Press ENTER to Exit ▲

```

Once point 1 and 2 are calibrated, return to the Calibrate Meter screen. Move the cursor to change to Resistance 2, designating the second calibration range. Proceed with the two-point calibration process as performed for the first range. This same process must be followed to complete the resistance calibration of all 5 ranges.

11.2.1.2 Temperature

```

A 0.28 μS/cm
A 25.00 °C
Calibrate Meter
Channel A Temperature ▲

```

Temperature is performed as a three point calibration. The table above shows the resistance values of these three points.

Navigate to the Calibrate Meter screen and choose Temperature calibration for either Channel A or B.

Press [ENTER] to begin temperature calibration process

```

A 0.28 μS/cm
A 25.00 °C
A Point1 = 1.0000 KΩ
A T = 1.0000 KΩ ▲

```

The first text line will ask for the Point 1 temperature resistance value (this will correspond to Temperature 1 value shown on the Calibration Module Accessory). The second text line will show the measured resistance value. When the value stabilizes, press [ENTER] to perform calibration.

The transmitter screen will then prompt the user to enter the value for Point 2, and T2 will display the measured resistance value. When this value stabilizes, press [ENTER] to calibrate this range.

Repeat these steps for Point 3.

```

A 0.28 μS/cm
A 25.00 °C
A Point2 = 3.0000 KΩ
A T = 3.0000 KΩ ▲

```

Press [ENTER] to bring up a confirmation screen. Select Yes to save the calibration values and the successful Calibration is confirmed on the display.

```

A 0.28 μS/cm
A 25.00 °C
Save Calibration Yes
Press ENTER to Exit ▲

```

The transmitter will return to the Measurement mode in approximately 5 seconds.

```

A 0.28 μS/cm
A 25.00 °C
Calibration Successful

```

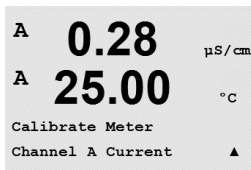

11.2.1.3 Current

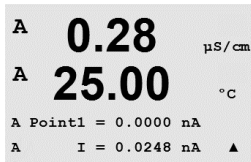

Current Calibration is performed as a two point calibration. Navigate to the Calibrate Meter screen and select Channel A or B and Current.

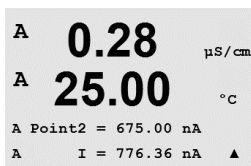

Enter the value for Point 1, in milliamps, of the current source connected to the input. The second display line will show the measured current. Press [ENTER] to begin the calibration process.



Enter the value for Point 2, in milliamps, of the current source connected to the input. The second display line shows the measured current.

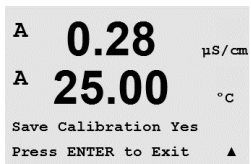

Pressing the [ENTER] key after entering Point 2 will bring up a confirmation screen. Select Yes to save the calibration values and the successful Calibration is confirmed on the display. The transmitter will return to the Measurement mode in approximately 5 seconds.

11.2.1.4 Voltage

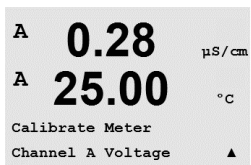

Voltage Calibration is performed as a two point calibration. Navigate to the Calibrate Meter screen and select Channel A or B and Voltage.

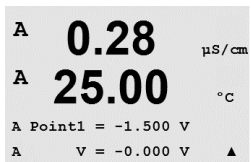

Enter the value for Point 1 in, volts, connected to the input. The second display line will show the measured voltage. Press [ENTER] to begin the calibration process.

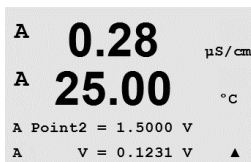

Enter the value for Point 2, in volts, of the source connected to the input. The second display line shows the measured voltage.

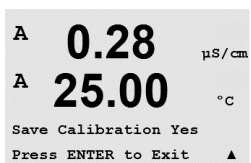

Pressing the [ENTER] key after entering Point 2 will bring up a confirmation screen. Select Yes to save the calibration values and the successful Calibration is confirmed on the display. The transmitter will return to the Measurement mode in approximately 5 seconds.

11.2.1.5 Rg Diagnostic

Rg Diagnostic is performed as a two point calibration. Navigate to the Calibrate Meter screen and select Channel A or B and Rg Diagnostic.

```
A 0.28  μS/cm
A 25.00 °C
Calibrate Meter
Channel A Rg Diagnostic▲
```

Enter the value for Point 1 of the calibration according to the resistor connected across the pH glass electrode measuring input. Press [ENTER] to begin the calibration process.

```
A 0.28  μS/cm
A 25.00 °C
A Point1 = 30.000 MΩ
A Rg = 572.83 Ω ▲
```

Enter the value for Point 2 of the calibration according to the resistor connected across the pH glass electrode measuring input.

```
A 0.28  μS/cm
A 25.00 °C
A Point2 = 500.00 MΩ
A Rg = 572.83 Ω ▲
```

Pressing the [ENTER] key after entering Point 2 will bring up a confirmation screen. Select Yes to save the calibration values and the successful Calibration is confirmed on the display. The transmitter will return to the Measurement mode in approximately 5 seconds.

```
A 0.28  μS/cm
A 25.00 °C
Save Calibration Yes
Press ENTER to Exit ▲
```

11.2.1.6 Rr Diagnostics

Rr Diagnostic is performed as a two point calibration. Navigate to the Calibrate Meter screen and select Channel A or B and Rr Diagnostic.

```
A 0.28  μS/cm
A 25.00 °C
Calibrate Meter
Channel A Rr Diagnostic▲
```

Enter the value for Point 1 of the calibration according to the resistor connected across the pH reference measuring input. Press [ENTER] to begin the calibration process.

```
A 0.28  μS/cm
A 25.00 °C
A Point1 = 30.000 KΩ
A Rr = 29.448 KΩ ▲
```

Enter the value for Point 2 of the calibration according to the resistor connected across the pH reference measuring input.

```
A 0.28  μS/cm
A 25.00 °C
A Point2 = 200.00 KΩ
A Rr = 29.446 KΩ ▲
```

Pressing the [ENTER] key after entering Point 2 will bring up a confirmation screen. Select Yes to save the calibration values and the successful Calibration is confirmed on the display. The transmitter will return to the Measurement mode in approximately 5 seconds.

```
A 0.28  μS/cm
A 25.00 °C
Save Calibration Yes
Press ENTER to Exit ▲
```

11.2.2 Calibrate Analog

Select the Analog Output you wish to calibrate. Each Analog output can be calibrated at 4 and 20 mA.

```
A 0.28 μS/cm
A 25.00 °C
Calibrate Analog
Analog Output 1 ▲
```

Connect an accurate milliamp meter to the Analog output terminals and then adjust the five digit number in the display until the milliamp meter reads 4.00 mA and repeat for 20.00 mA.

```
A 0.28 μS/cm
A 25.00 °C
Aout1 20mA Set 45000
Press ENTER when Done ▲
```

As the five digit number is increased the output current increases and as the number is decreased the output current decreases. Thus coarse changes in the output current can be made by changing the thousands or hundreds digits and fine changes can be made by changing the tens or ones digits.

```
A 0.28 μS/cm
A 25.00 °C
Aout1 4mA Set 08800
Press ENTER when Done ▲
```

Pressing the [ENTER] key after entering both values will bring up a confirmation screen. Selecting No will discard the entered values, selecting Yes will make the entered values the current ones.

```
A 0.28 μS/cm
A 25.00 °C
Save Calibration Yes
Press ENTER to Exit ▲
```

11.2.3 Calibrate Unlock

Select this Menu to configure the CAL Menu, see Section 7.

```
A 0.28 μS/cm
A 25.00 °C
Calibrate Unlock
```

Selecting Yes means that Meter and Analog Output calibration Menus will be selectable under the CAL Menu. Selecting No means that only the Sensor calibration is available under the CAL Menu. Press [ENTER] after the selection to display a confirmation screen.

```
A 0.28 μS/cm
A 25.00 °C
Unlock Calibration Yes
Press ENTER to Continue▲
```

11.3 Tech Service

(PATH: Menu/Tech Service)



Note: This Menu is for Mettler Toledo Service personnel use only.

12 Info

(PATH: Info)

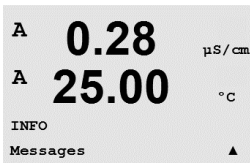
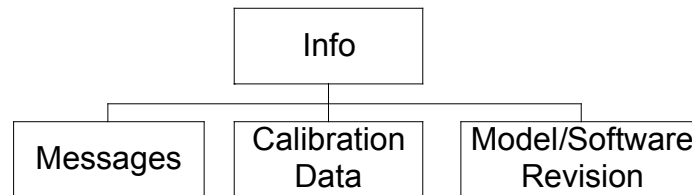

Pressing the ▼ key will display the Info Menu with the options Messages, Calibration Data and Model/Software Revision.

12.1 Messages

(PATH: Info/Messages)

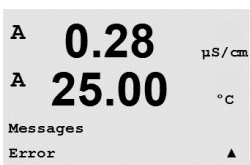

The most recent message is displayed. The up and down arrow keys allow scrolling through the last four messages that have occurred.

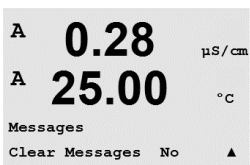

Clear Messages clears all the messages. Messages are added to the message list when the condition that generates the message first occurs. If all messages are cleared and a message condition still exists and started before the clear then it will not appear in the list. For this message to re-occur in the list the condition must go away and then reappear.

12.2 Calibration Data

(PATH: Info/Calibration Data)

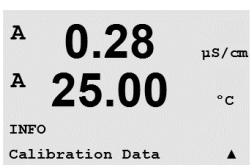

Selecting Calibration Data displays the calibration constants for each sensor. Use the up and down arrow keys to toggle between channels 'A' and 'B'.

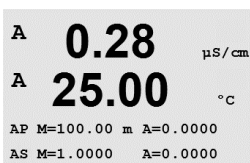

P = calibration constants for the primary measurement
 S = calibration constants for the secondary measurement

Press [ENTER] to exit from this display.

```

A 0.28 µS/cm
A 25.00 °C
INFO
Model/Software Revision▲

```

```

A 0.28 µS/cm
A 25.00 °C
PN xxxxxxxx Vx.xx
SN xxxxxxxxxx

```

12.3 Model/Software Revision

Selecting Model/Software Revision will display the model number, serial number and installed software revision.

The displayed information is important for any Service call. Press [ENTER] to return to the normal measurement mode.

13 Maintenance

13.1 For Technical Support

For technical support and product information for M300 Thornton Transmitters contact:

Mettler-Toledo Thornton, Inc.
 36 Middlesex Turnpike
 Bedford, MA 01730 USA
 Phone: 781-301-8600 or 800-510-PURE
 Fax: 781-271-0214
 Email: service@thorntoninc.com

Or: Your local Mettler-Toledo Sales Office or representative

13.2 Front Panel Cleaning

Clean the front panel with a damp soft cloth (water only, no solvents). Gently wipe the surface and dry with a soft cloth.

14 Troubleshooting

If the equipment is used in a manner not specified by Mettler-Toledo Thornton, Inc., the protection provided by the equipment may be impaired.

Review the table below for possible causes of common problems:

Problem	Possible Cause
Display is blank.	<ul style="list-style-type: none"> – No power to M300. – Blown fuse. – LCD display contrast set incorrectly. – Hardware failure.
Incorrect measurement readings.	<ul style="list-style-type: none"> – Sensor improperly installed. – Incorrect units multiplier entered. – Temperature compensation incorrectly set or disabled. – Sensor or transmitter needs calibration. – Sensor or patch cord defective or exceeds recommended maximum length. – Hardware failure.
Measurement readings not stable.	<ul style="list-style-type: none"> – Sensors or cables installed too close to equipment that generates high level of electrical noise. – Recommended cable length exceeded. – Averaging set too low. – Sensor or patch cord defective.
Displayed  is flashing.	<ul style="list-style-type: none"> – Setpoint is in alarm condition (setpoint exceeded).
Cannot change menu settings.	<ul style="list-style-type: none"> – User locked out for security reasons.

14.1 Changing the Fuse



Make sure that the mains cable is unplugged before changing the fuse. This operation should only be carried out by personnel familiar with the transmitter and who are qualified for such work.

If the power consumption of the M300 transmitter is too high or a manipulation leads to a short circuit the fuse will blow. In this case remove the fuse and replace it with one specified in Section [15](#).

15 Accessories and Spare Parts

Please contact your local Mettler-Toledo Sales office or representative for details for additional accessories and spare parts.

For M300 Thornton

Description	Part Number
Panel Mount Kit for ½ DIN models	52 500 213
Pipe Mount Kit for ½ DIN models	52 500 212
Configuration & Data Logger Software Kit	58 077 300
Adaptor Panel – M300 to 200/2000 cutout	58 083 300
M300 Conductivity Calibrator Module	58 082 300
Replacement power fuse 5x20 mm, 1 A, 250 V, time lag, Littlefuse or Hollyland	–

For M300

Description	Part Number
Pipe Mount Kit for ½ DIN models	52 500 212
Panel Mount Kit for ½ DIN models	52 500 213
Protective Hood for ½ DIN models	52 500 214
Configuration & Data Logger Software Kit	58 077 300

16 Specifications

16.1 General specifications

Conductivity/resistivity Specifications	
0.01 cm ⁻¹ constant sensor	0.002 to 200 µS/cm (5000Ω x cm to 500 MΩ x cm)
0.1 cm ⁻¹ constant sensor	0.02 to 2000 µS/cm (500Ω x cm to 50 MΩ x cm)
10 cm ⁻¹ constant sensor	10 to 40,000 µS/cm (25Ω x cm to 100 KΩ x cm)
4-electrode sensor	0.01 to 650 mS/cm (1.54Ω x cm to 0.1MΩ x cm)
Chemical concentration curves	HCl, NaOH, H ₂ SO ₄ : 0–20%, 0–15%, 0–20%
TDS range (CaCO ₃ and NaCl)	Covers equivalent conductivity ranges
Temperature input	PT 1000
Temperature measuring range	– 40 to + 200.0 °C (–40 to 392 °F)
Sensor maximum distance	61 m (200 ft); 15 m (50 ft with 4-E sensors)
Cond/Res accuracy	± 0.5% of reading or 0.25Ω, whichever is greater, Up to 10 MΩ-cm
Repeatability	± 0.1% of reading for resistance
Resolution	0.001 (four significant digits)
Temperature resolution	0.1 °C (0.1 °F)
Temperature relative accuracy	± 0.25°C (± 0.45 °F)
Temperature repeatability	± 0.13°C (± 0.23 °F)
Ratings/Approvals	UL Listed, CE Compliant
pH Specifications	
pH range	–1.00 to 15.00 pH
pH Resolution	0.01 pH
pH Relative accuracy	± 0.03 pH
mV range	–1500 to 1500 mV
mV Resolution	1 mv
mV Relative accuracy	± 2 mV
Temperature input	PT1000 (PT 100 with adapter)
Temperature measuring range	–30 to 130 °C (22 to 266 °F)
Dissolved Oxygen Specifications	
Measuring current	25 to 130 nA at 25 °C (77 °F), 1 bar (14.5 psi)
Saturation range	0 to 500%
Concentration range	0.00 to 20.00 ppm (mg/l)
Relative Accuracy	± 0.5% of full scale reading
Resolution	30pA
Temperature input	NTC 22 kΩ
Temperature measuring range	–10 to 80 °C (14 to 176 °F)
Dissolved Ozone Specifications	
Ozone range	0–5,000 ppb, 0–5 ppm
Ozone resolution	1 ppb, 0.001 ppm
Relative accuracy	± 2 % of reading or ± 3 ppb, system
Temperature input	PT 1000

16.2 Electrical specifications for 1/2DIN and 1/4DIN versions

Power requirements	100 to 240 V AC or 20 to 30 V DC, 5 W
Frequency	50 to 60 Hz
Analog output signals	Four 0/4 to 22 mA outputs, galvanically isolated from input and from earth/ground
Measurement Error through analog outputs	< 0.5% of full scale
Analog output configuration	Linear, Bi-Linear, Logarithmic, Autoranging
Load	max. 500 Ω
Connection terminals	Detachable screw terminals
Digital communication	USB port, Type B connector
PID process controller	Pulse length, pulse frequency or analog control
Connection terminals	Detachable screw terminals
Digital Input	2
Mains power fuse	1.0 A slow blow type FC
Relays	2-SPDT mechanical 250VAC, 30 VDC, 3 Amps resistive 2-Reed 250VAC or DC, 0.5 A, 10 W 2-SPST mechanical rated at 250VAC, 3Amps
Alarm Relay delay	0–999 s
Keypad	5 tactile feedback keys
Display	four-line

16.3 Mechanical specifications for 1/4DIN version

Dimensions (housing – H x W x D)*	96 x 96 x 140 mm (1/4DIN model)
Front bezel – (H x W)	102 x 102 mm
Max. depth	125 mm (excludes plug-in connectors)
Weight	0.6 kg (1.5 lb)
Material	ABS/polycarbonate
Ingress rating	IP 65 (front)/IP 20 (housing)

* H=Height, W=Width, D=Depth

16.4 Mechanical specifications for 1/2DIN version

Dimensions (housing – H x W x D)*	144 x 144 x 116 mm
Front bezel – H x W	150 x 150 mm
Max. D – panel mounted	87 mm (excludes plug-in connectors)
Weight	0.95 kg (2 lb)
Material	ABS/polycarbonate
Ingress rating	IP 65

* H=Height, W=Width, D=Depth

16.5 Environmental specifications for 1/2DIN and 1/4DIN versions

Storage temperature	–40 to 70 °C (–40 to 158 °F)
Ambient temperature operating range	–10 to 50 °C (14 to 122 °F)
Relative humidity	0 to 95% non-condensing
Emissions	According to EN55011 Class A
UL Electrical Environment	Installation (overvoltage) category II

17 Default tables

Alarm	Relay	2	
	Diagnostics	off	
	Power Failure	off	
	Software Failure	off	
	Delay	1	sec
	Hysteresis	0	
Clean	State	inverted	
	Relay	1	
	Hold Mode	NA	
	Interval	0	Hrs
	Clean Time	0	Sec
	State	normal	
Language	Delay	0	
	Hysteresis	0	
		English	
Passwords	Administrator	00000	
	Operator	00000	
All Relays (unless otherwise specified)	Delay	10	Sec
	Hysteresis	5	%
	State	normal	
	Hold mode	NA	
Lockout	(on/off)	no = off	
Channel A	Measurement a	Resistivity	Ω -cm
	Measurement b	temperature	$^{\circ}$ C
Channel B	Measurement c	Resistivity	Ω -cm
	Measurement d	Temperature	$^{\circ}$ C
Cal constants	Cond/Res	M=0.1, A=0.0	
	Dissolved Oxygen	M=1.0, A=0.0	
	pH	M=1.0, A=0.0	
	Dissolved Ozone	M=1.0, A=0.0	
	Temperature	M=1.0, A=0.0	
Analog Out	1	a – Cond/Resistivity	$M\Omega$ -cm
	2	b – temperature	$^{\circ}$ C
	3	c – Cond/Resistivity	$M\Omega$ -cm
	4	d – Temperature	$^{\circ}$ C
All analog out	Mode	4 – 20 mA	
	Type	normal	
	Alarm	off	
	Hold mode	last value	
Conductivity/Resistivity	Value 4 mA	10	$M\Omega$ -cm
	Value 20 mA	20	$M\Omega$ -cm
Dissolved Oxygen	Value 4 mA	0.000	ppb
	Value 20 mA	100.0	ppb
pH	Value 4 mA	2.000	pH
	Value 20 mA	12.00	pH
Dissolved Ozone	Value 4 mA	0.000	ppb
	Value 20 mA	20.00	ppm
Temperature	Value 4 mA	0	$^{\circ}$ C
	Value 20 mA	100	$^{\circ}$ C
Set point 1	Measurement	a	
	Type	Off	
	Value	0	
Relay 3	Set Point	1	
Set point 2	Measurement	c	
	Type	Off	
	Value	0	
Relay 4	Set Point	2	
Resolution	Temperature	0.1	$^{\circ}$ C
	Cond/Res	0.01	Ω -cm

18 Warranty

METTLER TOLEDO warrants this product to be free from significant deviations in material and workmanship for a period of one year from the date of purchase. If repair is necessary and not the result of abuse or misuse within the warranty period, please return by freight pre-paid and amendment will be made without any charge. METTLER TOLEDO's Customer Service Dept. will determine if the product problem is due to deviations or customer abuse. Out-of-warranty products will be repaired on an exchange basis at cost.

The above warranty is the only warranty made by METTLER TOLEDO and is lieu of all other warranties, expressed or implied, including, without limitation, implied warranties of merchantability and fitness for a particular purpose. METTLER TOLEDO shall not be liable for any loss, claim, expense or damage caused by, contributed to or arising out of the acts or omissions of the Buyer or Third Parties, whether negligent or otherwise. In no event shall METTLER TOLEDO's liability for any cause of action whatsoever exceed the cost of the item giving rise to the claim, whether based in contract, warranty, indemnity, or tort (including negligence).

19 UL Statement (Pending)

Mettler-Toledo Thornton, Inc., 36 Middlesex Turnpike, Bedford, MA 01730, USA has obtained Underwriters Laboratories' listing for M300 Model Transmitters. They bear the cULus Listed mark, signifying that the products have been evaluated to the applicable ANSI/UL and CSA Standards for use in the U.S. and Canada.

20 Buffer tables

M300 transmitters have the ability to do automatic pH buffer recognition. The following tables show different standard buffers that are automatically recognized.

20.1 Mettler-9

Temp (°C)	pH of buffer solutions			
0	2.03	4.01	7.12	9.52
5	2.02	4.01	7.09	9.45
10	2.01	4.00	7.06	9.38
15	2.00	4.00	7.04	9.32
20	2.00	4.00	7.02	9.26
25	2.00	4.01	7.00	9.21
30	1.99	4.01	6.99	9.16
35	1.99	4.02	6.98	9.11
40	1.98	4.03	6.97	9.06
45	1.98	4.04	6.97	9.03
50	1.98	4.06	6.97	8.99
55	1.98	4.08	6.98	8.96
60	1.98	4.10	6.98	8.93
65	1.99	4.13	6.99	8.90
70	1.99	4.16	7.00	8.88
75	2.00	4.19	7.02	8.85
80	2.00	4.22	7.04	8.83
85	2.00	4.26	7.06	8.81
90	2.00	4.30	7.09	8.79
95	2.00	4.35	7.12	8.77

20.2 Mettler-10

Temp (°C)	pH of buffer solutions			
0	2.03	4.01	7.12	10.32
5	2.02	4.01	7.09	10.25
10	2.01	4.00	7.06	10.18
15	2.00	4.00	7.04	10.12
20	2.00	4.00	7.02	10.06
25	2.00	4.01	7.00	10.01
30	1.99	4.01	6.99	9.97
35	1.99	4.02	6.98	9.93
40	1.98	4.03	6.97	9.89
45	1.98	4.04	6.97	9.86
50	1.98	4.06	6.97	9.83
55	1.98	4.08	6.98	9.83
60	1.98	4.10	6.98	9.83
65	1.99	4.13	6.99	9.83
70	1.99	4.16	7.00	9.83
75	2.00	4.19	7.02	9.83
80	2.00	4.22	7.04	9.83
85	2.00	4.26	7.06	9.83
90	2.00	4.30	7.09	9.83
95	2.00	4.35	7.12	9.83

20.3 NIST Technical Buffers

Temp (°C)	pH of buffer solutions				
0	1.67	4.00	7.115	10.32	13.42
5	1.67	4.00	7.085	10.25	13.21
10	1.67	4.00	7.06	10.18	13.01
15	1.67	4.00	7.04	10.12	12.80
20	1.675	4.00	7.015	10.06	12.64
25	1.68	4.005	7.00	10.01	12.46
30	1.68	4.015	6.985	9.97	12.30
35	1.69	4.025	6.98	9.93	12.13
40	1.69	4.03	6.975	9.89	11.99
45	1.70	4.045	6.975	9.86	11.84
50	1.705	4.06	6.97	9.83	11.71
55	1.715	4.075	6.97	9.83*	11.57
60	1.72	4.085	6.97	9.83*	11.45
65	1.73	4.10	6.98	9.83*	11.45*
70	1.74	4.13	6.99	9.83*	11.45*
75	1.75	4.14	7.01	9.83*	11.45*
80	1.765	4.16	7.03	9.83*	11.45*
85	1.78	4.18	7.05	9.83*	11.45*
90	1.79	4.21	7.08	9.83*	11.45*
95	1.805	4.23	7.11	9.83*	11.45*

*Extrapolated

20.4 NIST standard buffers (DIN 19266: 2000-01)

Temp (°C)	pH of buffer solutions			
0				
5	1.668	4.004	6.950	9.392
10	1.670	4.001	6.922	9.331
15	1.672	4.001	6.900	9.277
20	1.676	4.003	6.880	9.228
25	1.680	4.008	6.865	9.184
30	1.685	4.015	6.853	9.144
35	1.694	4.028	6.841	9.095
40	1.697	4.036	6.837	9.076
45	1.704	4.049	6.834	9.046
50	1.712	4.064	6.833	9.018
55	1.715	4.075	6.834	8.985
60	1.723	4.091	6.836	8.962
70	1.743	4.126	6.845	8.921
80	1.766	4.164	6.859	8.885
90	1.792	4.205	6.877	8.850
95	1.806	4.227	6.886	8.833



NOTE: The pH(S) values of the individual charges of the secondary reference materials are documented in a certificate of an accredited laboratory. This certificate is supplied with the respective buffer materials. Only these pH(S) values shall be used as standard values for the secondary reference buffer materials. Correspondingly, this standard does not include a table with standard pH values for practical use. The table above only provides examples of pH(PS) values for orientation.

20.5 Hach buffers

Buffer values up to 60 °C as specified by Bergmann & Beving Process AB.

Temp (°C)	pH of buffer solutions		
0	4.00	7.14	10.30
5	4.00	7.10	10.23
10	4.00	7.04	10.11
15	4.00	7.04	10.11
20	4.00	7.02	10.05
25	4.01	7.00	10.00
30	4.01	6.99	9.96
35	4.02	6.98	9.92
40	4.03	6.98	9.88
45	4.05	6.98	9.85
50	4.06	6.98	9.82
55	4.07	6.98	9.79
60	4.09	6.99	9.76
65	4.09*	6.99*	9.76*
70	4.09*	6.99*	9.76*
75	4.09*	6.99*	9.76*
80	4.09*	6.99*	9.76*
85	4.09*	6.99*	9.76*
90	4.09*	6.99*	9.76*
95	4.09*	6.99*	9.76*

*Values complemented

20.6 Ciba (94) buffers

Temp (°C)	pH of buffer solutions			
0	2.04	4.00	7.10	10.30
5	2.09	4.02	7.08	10.21
10	2.07	4.00	7.05	10.14
15	2.08	4.00	7.02	10.06
20	2.09	4.01	6.98	9.99
25	2.08	4.02	6.98	9.95
30	2.06	4.00	6.96	9.89
35	2.06	4.01	6.95	9.85
40	2.07	4.02	6.94	9.81
45	2.06	4.03	6.93	9.77
50	2.06	4.04	6.93	9.73
55	2.05	4.05	6.91	9.68
60	2.08	4.10	6.93	9.66
65	2.07*	4.10*	6.92*	9.61*
70	2.07	4.11	6.92	9.57
75	2.04*	4.13*	6.92*	9.54*
80	2.02	4.15	6.93	9.52
85	2.03*	4.17*	6.95*	9.47*
90	2.04	4.20	6.97	9.43
95	2.05*	4.22*	6.99*	9.38*

*Extrapolated

20.7 Merck Titrisols, Reidel Fixanals

Temp (°C)	pH of buffer solutions				
0	2.01	4.05	7.13	9.24	12.58
5	2.01	4.05	7.07	9.16	12.41
10	2.01	4.02	7.05	9.11	12.26
15	2.00	4.01	7.02	9.05	12.10
20	2.00	4.00	7.00	9.00	12.00
25	2.00	4.01	6.98	8.95	11.88
30	2.00	4.01	6.98	8.91	11.72
35	2.00	4.01	6.96	8.88	11.67
40	2.00	4.01	6.95	8.85	11.54
45	2.00	4.01	6.95	8.82	11.44
50	2.00	4.00	6.95	8.79	11.33
55	2.00	4.00	6.95	8.76	11.19
60	2.00	4.00	6.96	8.73	11.04
65	2.00	4.00	6.96	8.72	10.97
70	2.01	4.00	6.96	8.70	10.90
75	2.01	4.00	6.96	8.68	10.80
80	2.01	4.00	6.97	8.66	10.70
85	2.01	4.00	6.98	8.65	10.59
90	2.01	4.00	7.00	8.64	10.48
95	2.01	4.00	7.02	8.64	10.37

20.8 WTW buffers

Temp (°C)	pH of buffer solutions			
0	2.03	4.01	7.12	10.65
5	2.02	4.01	7.09	10.52
10	2.01	4.00	7.06	10.39
15	2.00	4.00	7.04	10.26
20	2.00	4.00	7.02	10.13
25	2.00	4.01	7.00	10.00
30	1.99	4.01	6.99	9.87
35	1.99	4.02	6.98	9.74
40	1.98	4.03	6.97	9.61
45	1.98	4.04	6.97	9.48
50	1.98	4.06	6.97	9.35
55	1.98	4.08	6.98	
60	1.98	4.10	6.98	
65	1.99	4.13	6.99	
70	2.00	4.16	7.00	
75	2.00	4.19	7.02	
80	2.00	4.22	7.04	
85	2.00	4.26	7.06	
90	2.00	4.30	7.09	
95	2.00	4.35	7.12	

Addresses