

ICS445 / ICS449 / ICS465 / ICS469

Weighing systems

ICS445



ICS449



ICS465

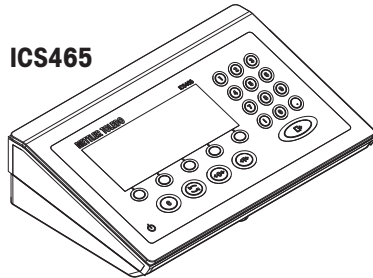

ICS469



METTLER TOLEDO

Table of Contents

1	Introduction	4
1.1	Safety instructions.....	4
1.2	Presentation.....	5
1.3	Commissioning.....	13
2	Operation	17
2.1	Switching on/off.....	17
2.2	Straight weighing.....	17
2.3	Switching units.....	17
2.4	Zeroing / Zero point correction.....	18
2.5	Weighing with tare.....	18
2.6	Displaying information.....	21
2.7	Printing results.....	22
2.8	Average (dynamic) weighing.....	23
2.9	Working with identifications.....	24
2.10	Working in a higher resolution.....	25
2.11	Switching scales.....	25
2.12	Working with a prompt.....	25
2.13	Calling up alibi log file.....	32
2.14	Cleaning.....	33
2.15	Verification test.....	34
3	Counting	35
3.1	Counting parts into a container.....	35
3.2	Counting parts out of a container.....	35
3.3	Determining the parts in a full container.....	36
3.4	Counting with a known average piece weight.....	36
3.5	Changing reference quantity.....	36
3.6	Counting with reference weight check.....	37
3.7	Reference optimization.....	38
3.8	Counting with automatic reference determination.....	38
3.9	Counting with reference and bulk scale.....	39
3.10	Counting by calling up an article from the database.....	40
4	Over/Under Checkweighing	42
4.1	Overview.....	42
4.2	Specifying target values for Over/Under Checkweighing.....	43
4.3	Specifying target number of pieces for Over/Under Checkcounting.....	43
4.4	Over/Under Checkweighing or Checkcounting procedure.....	44
4.5	Over/Under Checkweighing during subtractive weighing.....	44
4.6	Over/Under Checkweighing with "Quick start".....	45
4.7	Over/Under Checkweighing to zero.....	45
4.8	Over/Under Checkweighing by calling up an article from the database.....	46
4.9	Leaving Over/Under Checkweighing.....	47
5	Totalization	48
5.1	Totalizing manually.....	48
5.2	Automatic totalizing.....	49
5.3	Deleting items from the sum.....	49
5.4	Terminating totalizing.....	49
6	Settings in the menu	50
6.1	Menu overview.....	50
6.2	Operating the menu.....	50
6.3	Scale menu block.....	53
6.4	Application menu block.....	62

6.5	Terminal menu block.....	70
6.6	Communication menu block	75
6.7	Maintenance menu block.....	83
<hr/>		
7	Event and error messages	85
7.1	Error conditions	85
7.2	Errors and warnings.....	86
7.3	Smart weighing counter / spanner icon.....	87
7.4	Service information	87
<hr/>		
8	Technical data and accessories	88
8.1	Devices for dry environment	88
8.2	Devices for wet environment.....	95
8.3	General technical data.....	105
<hr/>		
9	Appendix	106
9.1	Metrological information	106
9.2	Table of Geo code values.....	106
9.3	Disposal	109
9.4	Protocol printouts.....	110
<hr/>		
	Index	111

METTLER TOLEDO Service

Congratulations on choosing the quality and precision of METTLER TOLEDO. Proper use of your new equipment according to this Manual and regular calibration and maintenance by our factory-trained service team ensures dependable and accurate operation, protecting your investment. Contact us about a service agreement tailored to your needs and budget. Further information is available at www.mt.com/service.

There are several important ways to ensure you maximize the performance of your investment:

- 1 **Register your product:** We invite you to register your product at www.mt.com/productregistration so we can contact you about enhancements, updates and important notifications concerning your product.
- 2 **Contact METTLER TOLEDO for service:** The value of a measurement is proportional to its accuracy – an out of specification scale can diminish quality, reduce profits and increase liability. Timely service from METTLER TOLEDO will ensure accuracy and optimize uptime and equipment life.
 - ➔ **Installation, Configuration, Integration and Training:** Our service representatives are factory-trained weighing equipment experts. We make certain that your weighing equipment is ready for production in a cost effective and timely fashion and that personnel are trained for success.
 - ➔ **Initial Calibration Documentation:** The installation environment and application requirements are unique for every industrial scale so performance must be tested and certified. Our calibration services and certificates document accuracy to ensure production quality and provide a quality system record of performance.
 - ➔ **Periodic Calibration Maintenance:** A Calibration Service Agreement provides on-going confidence in your weighing process and documentation of compliance with requirements. We offer a variety of service plans that are scheduled to meet your needs and designed to fit your budget.

1 Introduction

1.1 Safety instructions

General

- Do not use the device in a hazardous environment. Special devices are available in our range of products for hazardous environments.
- The safety of the device cannot be ensured if it is not operated in accordance with these operating instructions.
- Only authorized personnel may open the device.



CAUTION

Risk of personal injury, damage to property, erroneous operation or voided warranty

Use only genuine METTLER TOLEDO accessories and cable assemblies with this product. Use of unauthorized or counterfeit accessories or cable assemblies may result in voided warranty, improper or erroneous operation, or damage to property (including the unit) and personal injury.

Devices with protection level IP5x or IP65

Devices with protection level IP54 or IP65 are protected against dust and splashing of water respectively dust-tight and protected from water jets according to EN 60529. They are suitable for use in dusty environments and brief contact with liquids.

- Ensure that the device is dried off after coming into contact with liquid.
- Do not use the device in environments with a risk of corrosion.
- Do not flood the device or submerge it in liquid.

Devices with built-in power supply unit

- Ensure that the power socket outlet for the device is earthed and easily accessible, so that it can be de-energized rapidly in emergencies.
- Ensure that the supply voltage at the installation site lies within the range of 100 V to 240 V.
- Ensure that there is a space of at least 3 cm (1.25") at the rear in order to prevent the power cable from being bent too strongly.
- Check the power cable regularly for damage. If it is damaged, immediately disconnect the device from the power supply unit.

Devices with built-in storage battery

- Only use storage batteries from the manufacturer.
- Do not use the battery charger in humid or dusty rooms or below 0 °C (32 °F) ambient temperature.
- After the storage battery has been charged, the cover cap of the charging socket on the device must be closed.



WARNING

Explosion hazard

Use only genuine METTLER TOLEDO replacement battery packs and rechargers as listed in the applicable User Manual. Use of anything other than genuine METTLER TOLEDO battery packs or chargers may cause fire or explosion resulting in serious personal injury up to and including death or property damage.

Batteries must be disposed of properly in accordance with local environmental and any other applicable regulatory requirements. Do not discard in normal domestic waste.

Compact scales / Terminal and platform combinations

- Avoid falling and shock loads as well as any impact from the side.
- The maximum static safe load must never be exceeded. Observe the operation limits, see technical data of the connected weighing platform.

1.2 Presentation

1.2.1 Type overview

ICS445 / ICS449 / ICS465 / ICS469 weighing terminals vary in the following:

	ICS445	ICS449	ICS465	ICS469
Numeric keypad	–	–	X	X
Color display	–	X	X	X
Environment	dry	wet	dry	wet
Available as compact scale	X	–	X	–
Available as terminal and platform combination	X	X	X	X

Default equipment

Each weighing terminal offers the following interfaces:

- 1 serial RS232 interface
- 1 scale interface

Optional equipment

The weighing terminals can be equipped or retrofitted with an additional interface:

- RS232 (usable as data interface or SICS scale)
- RS422/485 (usable as data interface or scale interface SICSpro)
- USB Device
- USB Host
- Ethernet
- WLAN
- Digital I/O
- Analog scale
- IDNet

1.2.2 Display

To meet your special requirements, different display layouts are available in the menu under `Terminal -> Device -> Display -> Display layout`.

Straight weighing display – Default layout

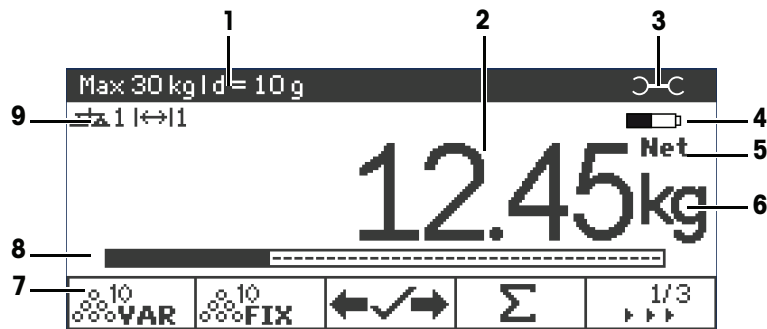

- | | | |
|---|--|---|
| 1 | Metrological data | For details see following table |
| 2 | Weight value with star, sign and stability monitor | For details see following table |
| 3 | Spanner icon: service needed | For details see Event and error messages |
| 4 | Battery symbol | |
| 5 | Net/Gross | |
| 6 | Unit | |
| 7 | Soft keys (factory setting, page 1) | |
| 8 | Auxiliary data line | The contents is defined in the menu; here: bargraph |
| 9 | Symbol and info line | For details see following table |

Straight weighing display – 3-line mode



Straight weighing display – Big font mode



Straight weighing display – Bargraph

The device offers a bargraph indicating the scale capacity.



The bargraph indicates roughly which part of the scale capacity is already occupied and what capacity is still available.

In the example above, approximately 3/4 of the scale capacity is occupied, although the applied net weight isn't really high. The reason therefore could be a high tare weight.

Metrological data line

i The metrological data is stored in the weighing platform. The weighing terminal only serves as indicator.

In the metrological data line the following information is displayed:

Symbol	Information	Remark
	Accuracy classes	Displayed only if the scale is approved according to the Weights and Measures guidelines
w1 , w2 , w3	Weighing range information	For multi range devices only and if the scale is approved according to the Weights and Measures guidelines
Max , cap	Maximum capacity	cap for NTEP only
Min	Minimum capacity	Displayed only if the scale is approved according to the OIML Weights and Measures guidelines
e =	Approved resolution	Displayed only if the scale is approved (OIML)
d =	Display resolution	Please note for approved scales: OIML : Displayed only if d is different from e NTEP : Always displayed
Approved scale	Approved weighing device	Metrology display disabled for SICS scales, e.g., BBK422. Weights and Measures data must be indicated on a label near the weight display.







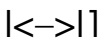

Weight value

The weight value can be marked with the following symbols:

Symbol	Information	Remark
*	Calculated weight value	For example for average weighing results
—	Sign	For negative weight values
○	Stability monitor	For unstable weight values
1.234₃ kg	Non-approved last digit with $e>d$	For approved scales only The example shows the weight value for a scale with $e=1\text{g}$ and $d=0.1\text{g}$. The last, smaller digit is not approved.





Symbols and info line

In the symbols and info line the following information can be displayed:

Symbol	Information	Remark
	Scale number	Displayed only if 2 scales are connected
	Weighing range	For multi range or multi interval scales only
	Weight below minimum weight	<code>MinWeigh</code> must be activated in the menu
	Average weighing	<code>Average</code> must be activated in the menu
	Automatic taring	<code>Auto Tare</code> must be activated in the menu
	Automatic clearing of the tare weight	<code>A-Clear Tare</code> must be activated in the menu
	Over/Under checkweighing to zero	<code>To zero</code> must be assigned to a soft key in the menu
	Center of zero indication	Availability depending on local Weights and Measures regulations
	Automatic APW optimization	<code>APW optimization</code> must be set to <code>Auto</code>
	Totalization	Totalization active
Fact	Fact needs to be performed	Fact = Fully automatic calibration test. When Fact is displayed: Ensure that the weighing platform is empty and wait until the calibration test is done automatically. For ICS4_5k-.../f compact scales only.

1.2.3 Keyboard

Function keys

Key	Name	Function in the operating mode	Function in the menu
	Power	<ul style="list-style-type: none"> Switching on and off Cancelling editing 	<ul style="list-style-type: none"> Cancelling editing Exiting menu
C	Clear	<ul style="list-style-type: none"> Clearing tare Leaving info page Leaving application 	<ul style="list-style-type: none"> Clearing value Clearing digit
	Switch	<ul style="list-style-type: none"> Switching over weight unit 	<ul style="list-style-type: none"> Re-editing
	Zero	<ul style="list-style-type: none"> Setting scale to zero Clearing tare 	
	Tare	<ul style="list-style-type: none"> Taring scale Clearing previous tare 	
i	Info	<ul style="list-style-type: none"> Activating info screen Proceeding to the next info line / info page Freezing and releasing startup screen 	
	Transfer	<ul style="list-style-type: none"> Transferring data to a printer or computer 	<ul style="list-style-type: none"> Confirming entry/selection

Soft keys

To meet your specific application requirements, **ICS445 / ICS449 / ICS465 / ICS469** offer 16 soft keys which can be configured in the `Terminal` menu. The soft keys are divided into four lines (pages).

Factory setting ICS44_

Page 1



Fix reference
here: 10 pieces

APW

Higher resolution

ID1

Scroll to page 2

Page 2



Alibi memory

Switch scale

Scroll to page 3

Factory setting ICS46_

Page 1



Variable reference
here: 10 pieces

Fix reference
here: 10 pieces

Over/Under
Checkweighing

Totalizing

Scroll to page 2

Page 2



Save Over/Under
Checkweighing
parameters

Load Over/Under
Checkweighing
parameters

Alibi memory

Switch scale

Scroll to page 3

Page 3, Page 4

Pages 3 and 4 are free for customer configuration.
When scrolling further after the last page, page 1 is displayed again.

Operating soft keys

- Press the key below the desired function.

Soft key options

Symbol	Menu setting	Function
	Zero	
	Tare	
	High resolution	Show the weight value with 10 times higher resolution
	Average weighing	Start average weighing
ID1	ID1, ID2, ID3	Enter identifications
ID2		
ID3		
Prompt	Prompt	Start a predefined workflow. The user will be guided step by step.
Alibi	Alibi memory	Call up the optional alibi memory
	Switch scale	Switch between the connected scales
	Ref n var	Determine the average piece weight, freely adjustable
	Ref n fix	Determine the average piece weight, fixed reference sizes
	APW	Enter the average piece weight
	APW optimization	Reference weight optimization
	Weight/count	Switch between weight display and display of pieces
	Totalizing	
	Over/Under Checkweighing	Enter Over/Under Checkweighing parameters
	Save article	Save the current article parameters in the database
	Recall article	Recall parameters from the database
	Display layout	Switch between default weight display and 3-line mode
#	Consecutive number	Enter start value for printout with consecutive number

1.2.4 Connections

ICS4_5 weighing terminal for dry environments

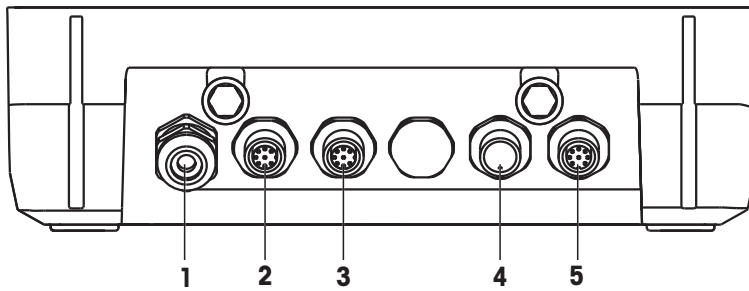

- | | | | |
|----------|-------------------------------------|----------|-------------------------------------|
| 1 | AC power supply or battery charging | 2 | Standard interface COM1 (RS232) |
| 3 | Optional interface COM2 | 4 | Weighing platform connection SCALE2 |
| 5 | Weighing platform connection SCALE1 | | |

ICS4_9 weighing terminal for wet environments

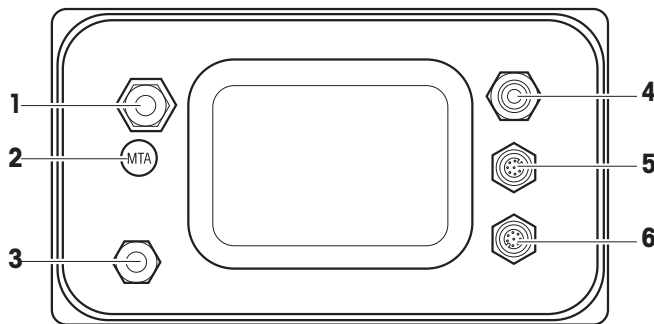

- | | | | |
|----------|---------------------------------|----------|-------------------------------------|
| 1 | Weighing platform connection | 2 | Verification securing seal |
| 3 | Pressure compensation | 4 | AC power supply or battery charging |
| 5 | Standard interface COM1 (RS232) | 6 | Optional interface COM2 |

ICS4_9a-.../c

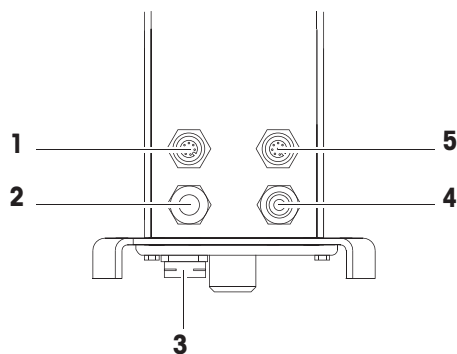

- | | | | |
|----------|---------------------------------|----------|-------------------------------------|
| 1 | Optional interface COM2 | 2 | Analog weighing platform connection |
| 3 | Pressure compensation | 4 | AC power supply or battery charging |
| 5 | Standard interface COM1 (RS232) | | |

The verification securing seal is applied directly on the weighing terminal.

1.3 Commissioning

1.3.1 Selecting the location

CAUTION

Limited cable lengths

- A cable length of 30 m between weighing terminal and weighing platform as well as between weighing terminal and external devices (like printer, PC, etc.) must not be exceeded.

The correct location is crucial for the accuracy of the weighing results.

- 1 Select a stable, vibration-free and, if possible, a horizontal location for the weighing platform.
 - ➔ The ground must be able to safely bear the weight of the fully loaded weighing platform.
- 2 Observe the following environmental conditions:
 - ➔ No direct sunlight
 - ➔ No strong drafts
 - ➔ No excessive temperature fluctuations

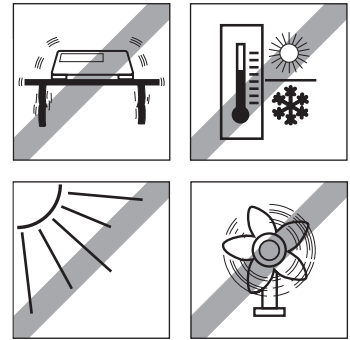

1.3.2 Levelling

Levelling of weighing platforms

Only weighing platforms that have been levelled precisely horizontally, provide accurate weighing results. Weights and Measures approved weighing platforms have a level bubble to simplify levelling.

- Turn the adjustable feet of the weighing platform until the level bubble's air bubble is inside the inner circle.

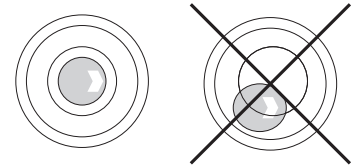

Levelling of compact scales ICS4_5-.../f

On compact scales levelling can be done in an easier way.

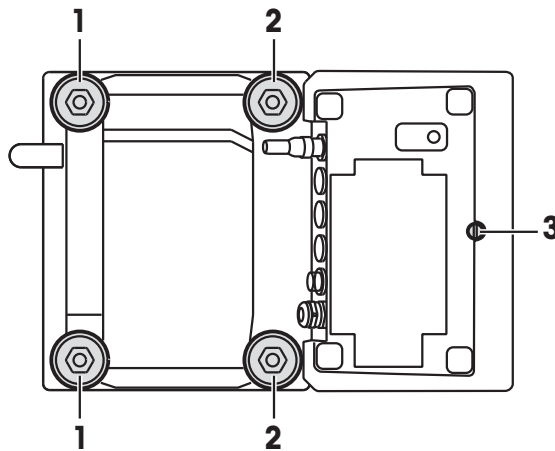

- 1 Turn the compact scale upside down.
- 2 Screw in the 2 adjustable feet (2) on the terminal side of the weighing platform.
- 3 Turn over the compact scale to its normal position.
- 4 Level the compact scale by turning the other 2 adjustable feet (1) of the weighing platform until the level bubble is inside the inner circle.
- 5 Screw out the feet (2) of the weighing platform until they have contact with the table.

 The adjustable foot (3) of the weighing terminal is screwed out for 7 mm at the factory and needs not be adjusted for levelling.

1.3.3 Weighing platform connection

Analog weighing platforms

- Call the METTLER TOLEDO service technician to connect an analog weighing platform to the **ICS4_5g / ICS4_9g** weighing terminal.

Weighing platforms with digital scale interface

- Connect the weighing platform connector to the **ICS4_5i / ICS4_9i** or **ICS4_5s / ICS4_9s** weighing terminal.

- 
- If you have ordered an approved weighing system consisting of an **ICS4_5s** weighing terminal and an approved PBD555 weighing platform, the approval was done in the factory (not for the US market).
 - You can disconnect the weighing platform from the **ICS4_5s / ICS4_9s** or **ICS4_5i / ICS4_9i** weighing terminal of an approved weighing system without violating the approval. If another weighing platform is connected to the weighing terminal, the system is not approved. If the weighing platform of the approved system is connected again, the approval is valid again.
 - If you have ordered an approved weighing system consisting of an **ICS4_5s / ICS4_9s** weighing terminal and an approved PBK/PFK weighing platform, the approval was done in the factory (not for the US market).
 - If you have connected a non-approved weighing platform and want to have the system approved, call the **METTLER TOLEDO** service technician.

1.3.4 Power supply connection



CAUTION

Risk of electric shock!

- 1 Before connecting the power supply, check whether the voltage value printed on the label corresponds to your local system voltage.
- 2 Do not, under any circumstances, connect the device if the voltage value on the label deviates from the local system voltage.
- 3 Make sure the weighing platform has reached room temperature before switching on the power supply.

- Plug the power plug into the power socket.
- ➔ After it has been connected, the device runs a self-test. The device is ready to operate when zero appears on the display.

1.3.5 Handling the storage battery

Battery symbol

The battery symbol shows the current charging status of the storage battery.



- One segment corresponds with approx. 25 % capacity.
- If the symbol flashes, the storage battery has to be charged.
- During charging the segments are "running" until the battery is fully charged and all segments light up continuously.

Note the following when operating a device with a built-in storage battery:

- Before the first operation charge the storage battery for at least 3 hours.
- The operating life depends on the intensity of use, the configuration, and the connected scale. For details concerning **ICS4_5**, see "[Operating life with battery ▶ Page 91]", or concerning **ICS4_9**, see "[Operating life with battery ▶ Page 96]".
- The charging time of the storage battery amounts to 4 to 5 hours. The storage battery is protected against overcharging.
- The storage battery has a service life of 500 to 1,000 charging/discharging cycles.



CAUTION

Charging the storage battery below 0° C (32 °F) or above 40 °C (104 °F) is prevented by the charging electronics!

- Make sure that the temperature is within the range of 0 °C to 40 °C (32 °F to 104 °F) to charge the storage battery.



CAUTION

Danger of soiling because the charger for the storage battery is not protected according to IP69K!

- 1 Do not charge the device in humid or dusty rooms.
- 2 After the storage battery has been charged, close the cover cap of the charging socket on the device.

Recommended use of the storage battery

The characteristics mentioned above are only valid if the following recommendations are observed:

- Change the battery as soon as the warning message "Low battery" appears and the battery symbol starts flashing. When the message appears, you still have enough time (at least 10 minutes), to complete your current task.
- For optimum battery performance, operate the device with built-in storage battery at an ambient temperature range of 10 °C to 30 °C (50 °F to 86 °F). This also applies to discharging the battery.

Changing battery (ICS4_5 only)

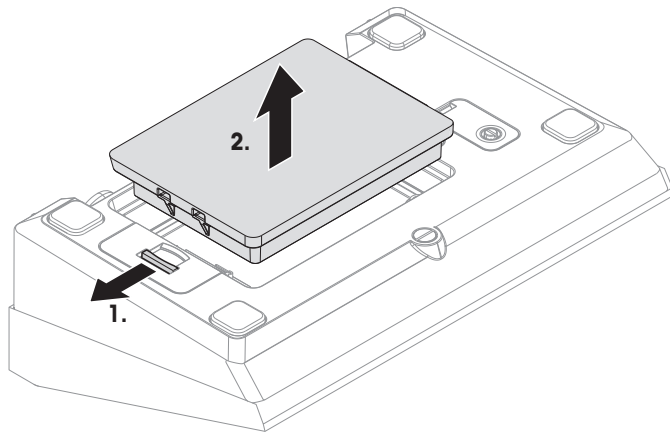

- 1 Unlock the battery by moving the slider away from the battery and remove the discharged battery.
- 2 Insert the fully charged battery and secure it by moving the slider towards the battery.

i With optional IP65 protection, the battery is not accessible from the outside. Please call the **METTLER TOLEDO** service technician.

1.3.6 Use in hygienically sensitive areas

ICS4_9 weighing terminals are easy to clean and are designed to be used in the food industry.

ICS4_9 features

- Protection degree IP68/69k
- Terminal housing and load plate made of stainless steel
- No open threads
- No screws with recesses
- Keypad made of PET with a smooth surface
- Reduced horizontal surfaces
- Continuous welding seams

i The standard load cell is made of aluminium. As an option, stainless steel potted and hermetically sealed load cells are available.

2 Operation

2.1 Switching on/off

Switching on

– Press .

➔ For a few seconds the device shows a start-up screen with device name, software version, serial number of the weighing terminal and the Geo Code value.



- You can freeze the start-up screen by pressing **i**.
- When you start a compact scale, the metrology line shows whether it is approved or not. If you have ordered an approved weighing system, approval has been done in the factory already (not for the US market).
- With **ICS4_5k-.../f** compact scales ensure that the device is at room temperature before switching on. **To ensure accurate weighing results, wait 15 minutes after switching on before starting weighing operation.**

Switching off

– Press .

➔ Before the display goes out, **-OFF-** appears briefly.

Resetting

– Press and hold  for approx. 5 seconds.

➔ The device is switched off.

2.2 Straight weighing

- 1 Place weighing sample on the scale.
- 2 Wait until the stability monitor  disappears.
- 3 Read the weighing result.

2.3 Switching units

If an additional second weight unit is configured in the menu, it is possible to switch back and forth between the two weight units.

– Press .

➔ The weight value is displayed in the second unit.



- Possible units are g, kg, oz, lb, lb-oz, t and PCS in piece counting.
- When in the menu **Scale -> Disp. unit & res. -> Unit roll** is set to **On**, the weight value can be displayed in all available weight units by repeatedly pressing .

2.4 Zeroing / Zero point correction

Zeroing corrects the influence of slight changes on the load plate or minor deviations from the zero point.

Manual

- 1 Unload scale.
- 2 Press **→0←**.
 - Zero appears in the display.

Automatic

In case of non-approved scales, the automatic zero point correction can be deactivated in the menu or the zero range can be changed. Approved scales are set fixed at 0.5 d per second.



- The zero function is only available within a limited weighing range.
- After zeroing the scale, the whole weighing range is still available.

2.5 Weighing with tare

2.5.1 Taring

- Place the empty container on the scale and press **→T←**.
 - The zero display and the symbol **NET** appear.
 - The tare weight remains stored until it is cleared.

2.5.2 Clearing the tare

- Press **C**.
 - The symbol **NET** goes out, the gross weight appears in the display.



If the symbol  is displayed, i.e., the tare function `Auto clear tare` is activated in the `Scale` menu, the tare weight is automatically cleared as soon as the scale is unloaded.

2.5.3 Automatic clearing the tare

A tare weight is automatically cleared when the scale is unloaded.

Prerequisite

The symbol  is displayed, i.e., the tare function `Auto clear tare` is activated in the `Scale` menu.



The tare weight must be heavier than 9 scale divisions.

2.5.4 Automatic taring

If you place a weight on an empty scale, the scale tares automatically and the symbol **NET** is displayed.

Prerequisite

The symbol  is displayed, i.e., the tare function `Auto tare` is activated in the `Scale` menu.



The weight to be tared automatically, e.g., packaging material, must be heavier than 9 scale divisions.

2.5.5 Chain tare

With this function it is possible to tare several times if, e.g., cardboard is placed between individual layers in a container.

- The tare function `Chain tare` is activated in the `Scale` menu.
- 1 Place the first container or packaging material on the scale and press **→T←**.
 - ➔ The packaging weight is automatically saved as the tare weight, the zero display and the symbol **NET** appear.
 - 2 Load the sample and read/print out the result.
 - 3 Place the second container or packaging material on the scale and press **→T←** again.
 - ➔ The total weight on the scale is saved as the new tare weight. The zero display appears.
 - 4 Load the sample in the second container and read/print the result.
 - 5 Repeat steps 3 and 4 for other containers.

2.5.6 Tare preset

For established container weights enter the tare weight numerically or via barcode / SICS command. Thus, you do not have to tare the empty container.

 The entered tare weight is valid until a new tare weight is entered or the tare weight is cleared.

Tare preset with numeric entry

- 1 Enter the known tare weight and press **→T←** to confirm.
 - ➔ The weight display shows the negative tare weight and the symbol **NET** appears.
- 2 Place the full container on the weighing platform.
 - ➔ The net weight is displayed.

 Tare preset with numeric entry is only available for **ICS465** and **ICS469**.

Tare preset with barcode entry

- For barcode use, `Tare preset` is selected as destination for external input in the menu under `Communication -> COMx -> External input -> Destination`.
- 1 Enter the known tare weight via barcode.
 - ➔ The weight display shows the negative tare weight and the symbol **NET** appears.
 - 2 Place the full container on the weighing platform.
 - ➔ The net weight is displayed.

Tare preset with SICS command from a connected computer

- 1 Enter the known tare weight on the computer using the SICS command `TA_Value_Unit`.
 - ➔ The weight display shows the negative tare weight and the symbol **NET** appears.
- 2 Place the full container on the weighing platform.
 - ➔ The net weight is displayed.

2.5.7 Storing/recalling tare weights (pure tare articles)



- Pure tare articles are articles in the database in which the tare weight and an optional description only are stored.
- Recalling a pure tare article allows you to tare the scale even during counting, checkweighing or totalizing applications without interrupting the weighing application.
- The software tool METTLER TOLEDO Data+ offers the possibility to define articles on a PC and to transfer this information to the database of the weighing terminal, see www.mt.com/DataPlus.

Storing tare weights in the database

- The soft key **Save article** () is activated in the menu under `Terminal -> Device -> Keyboard -> Soft keys`.

- 1 Determine a tare weight as described before.
- 2 Press the soft key .
 - ➔ A new screen is displayed to enter an article. The tare weight is filled in, but no other weight value.
- 3 Confirm the pure tare article with the soft key .
 - ➔ **Record stored** is displayed briefly. The article is stored.



- If the `Description` field is activated in the `Application -> Database` menu, you are able to enter an article description as well.
- If the selected article already exists, the message **Article already exists – Overwrite article?** is displayed.

Recalling tare weights from the database

- The soft key **Load article** () is activated in the menu under `Terminal -> Device -> Keyboard -> Soft keys`.

- 1 Press the soft key .
 - ➔ The database opens. The article data of the first database record are displayed.
 - ➔ For a pure tare article the "Tare" field is significant.
- 2 Use the soft keys / to navigate through the database records. On the second soft key page, the soft keys and are available to scroll in steps of 5.
- 3 Confirm the selected data record with the soft key .
 - ➔ **Record loaded** is displayed briefly. Net and tare weight are displayed.

Database			
Article:	123	Tol type:	Absolute
Desc.:		T-:	0.00 kg
Tare:	0.72 kg	T:	0.00 kg
APW:	0.00 kg	T+:	0.00 kg
ESC		OK	

2.6 Displaying information

Up to 5 different items can be configured in the menu for the **i** key. Depending on the configuration in the menu under `Terminal -> Device -> Keyboard -> Info key`, the following data can be assigned in any order, e.g.,

- Date & Time
- Weight values
- Identifications
- Article information
- Application parameters
- Device information
- Serial numbers and software versions
- Network information

On the second and third info page, system and contact information can be displayed.

1 Press **i**.

➔ The (first) info page is displayed.

2 Press **i** again.

➔ The next info screen is displayed.

3 To leave the info screens, press **C**.

i An info screen is displayed until **i** is pressed again or until **C** is pressed.

2.7 Printing results

If a printer or computer is connected, weighing results and other information can be printed out or transferred to a computer.

– Press .

➔ The defined data is printed out or transferred to the computer.



- The printout content can be defined in the menu under `Communication -> COMx -> Define Templates`. The template has to be assigned to the printout in the `Application` menu.
- If in the `Application` menu `Memory mode` is set to `Alibi` or `Transaction`, the weighing result is stored in the memory when pressing .

Printing without pressing a key (clever print)

■ In the menu `Application -> Clever print -> Activate` is set to `On`.

■ To initiate the next printout, the weight must drop below the set threshold.

1 Put the weighing sample on the load plate.

➔ When a stable weight value is reached, the result is printed automatically.

2 Remove the weighing sample from the load plate and load the next weighing sample.

➔ When the weight value has dropped below the set threshold, the next stable weight value is printed automatically.

Printout with consecutive number

The device offers the possibility to number the weighings on the printout.

■ In the selected template `Consecutive number` is assigned to a line.

■ To define a start value, a soft key must be defined as `Consecutive number ()` in the menu under `Terminal -> Device -> Keyboard -> Soft keys`.

Date	11/04/2014
Time	17:17:39
Gross	0.815 kg
Cons. no	10

1 To enter a start value for the consecutive number, press the soft key .

2 Enter the desired start number and confirm with .

➔ The weighing results are printed out with a consecutive number, beginning at the entered start number.



- If no start value is entered, the consecutive number will start with 1.
- The consecutive number can be displayed in the auxiliary line as well (`Terminal -> Device -> Display -> Auxiliary line -> Consecutive number`)

2.8 Average (dynamic) weighing

With the average weighing function, it is possible to weigh moving weighing samples such as animals. If this function is activated,  is displayed in the info line. With average weighing, the scale calculates the mean value from weighing operations within a certain time interval.

Start via soft key (factory setting)

- Weighing sample heavier than 9 scale divisions.
- 1 Place the weighing sample on the scale.
- 2 Press the soft key  to start average weighing.
 - ➔ During average weighing, stars appear in the display, and the average result will be displayed with the symbol *****.
- 3 Unload the scale to begin a new average weighing operation.

Start via hard key

- Application -> Average Weighing -> Mode -> Print key (factory setting), Info key or Switch key is selected in the menu.
- Weighing sample heavier than 9 scale divisions.
- 1 Place the weighing sample on the scale.
- 2 Press the key defined in the menu to start average weighing.
 - ➔ During average weighing, stars appear in the display, and the average result will be displayed with the symbol *****.
- 3 Unload the scale to begin a new average weighing operation.







With automatic start

- Application -> Average -> Mode -> Auto is selected in the menu.
- Weighing sample heavier than 9 scale divisions.
- 1 Place the weighing sample on the scale.
 - ➔ Average weighing starts automatically.
 - ➔ During average weighing, stars appear in the display, and the average result will be displayed with the symbol *****.
- 2 Unload the scale to start a new average weighing operation.

2.9 Working with identifications

Weighing series can be assigned with 3 identification numbers ID1, ID2 and ID3 with up to 24 numeric characters that are also printed out in the protocols. If, for example, a customer number and a batch number are assigned, it can be clearly seen in the protocol which batch was weighed for which customer.

Direct entry (ICS445 and ICS449 only)

- At least one of the soft keys ID1, ID2 or ID3 is activated in the menu under Terminal -> Device -> Keyboard -> Soft keys.
 - To display the identification in the auxiliary line, ID1, ID2 or ID3 must be activated in the menu under Terminal -> Device -> Display -> Auxiliary line.
- 1 Press the desired soft key **ID1**, **ID2**, **ID3**.
 - ➔ The ID entered last is displayed.
 - 2 To edit the ID, press the soft key .
 - 3 Enter the ID using the , , ,  soft keys.
 - 4 Confirm entry with .
 - ➔ The entered ID is assigned to the following weighings until the ID is changed.

Direct entry (ICS465 and ICS469 only)

- At least one of the soft keys ID1, ID2 or ID3 is activated in the menu under Terminal -> Device -> Keyboard -> Soft keys.
 - To display the identification in the auxiliary line, ID1, ID2 or ID3 must be activated in the menu under Terminal -> Device -> Display -> Auxiliary line.
- 1 Press the desired soft key **ID1**, **ID2**, **ID3**.
 - ➔ The ID entered last is displayed.
 - 2 Enter the ID via the numeric keyboard and confirm with .
 - ➔ The entered ID is assigned to the following weighings until the ID is changed.

Barcode use (for one identification only)

- ID1, ID2 or ID3 is selected as destination for external input in the menu under Communication -> COMx -> External input -> Destination.
 - To display the identification in the auxiliary line, ID1, ID2 or ID3 has to be activated in the menu under Terminal -> Display -> Auxiliary line.
- Scan the ID.
 - ➔ The ID is assigned to the following weighings until a new ID is scanned.

Using SICS command set (up to three identifications)

- To display the identification in the auxiliary line, ID1, ID2 or ID3 has to be activated in the menu under Terminal -> Display -> Auxiliary line.
- Send the ID command (I12, I13 or I14) from a PC.
 - ➔ The ID is assigned to the following weighings until a new ID is sent.

2.10 Working in a higher resolution

The weight value can be displayed in a higher resolution continuously or when called.

- Soft key `x10 Display` is activated in the `Terminal` menu.
- Press soft key `x 10`.
 - ➔ The weight value is displayed in a resolution at least 10x higher and is marked with the symbol *****.
 - ➔ The higher resolution is displayed until the soft key `x 10` is displayed again.



With approved weighing platforms, the weight value appears in a higher resolution for 3 seconds after the soft key `x 10` is pressed.

2.11 Switching scales

- Two scales are connected to the weighing terminal.
- The soft key `Switch scale` is activated in the `Terminal` menu.
- Press the soft key `↔` to switch the active scale.
 - ➔ The current active scale is displayed in the symbol and info line on the top of the display.

2.12 Working with a prompt

2.12.1 Prompt overview

The device offers prompts for frequently used workflows. The weighing terminal will then lead you from step to step.

In the `Application` menu one of the following prompts can be activated:

- `Tare/Sample` – counting with first taring and then determining the average piece weight
- `Sample/Tare` – counting with first determining the average piece weight and then taring
- `Hands free` – counting without pressing any key
- `Multi tare` – taring several containers with the same tare weight
- `Additive tare` – adding different tare values
- `Take away` – checkweighing out of a container



- During prompting, no other soft keys are available.
- To start a prompt, the soft key `Prompt` must be activated in the `Terminal` menu.

2.12.2 Tare/Sample

This prompt will guide you through piece counting with first taring and then determining the average piece weight.

Put tare on and press ->	
--------------------------	---

Put ref.on and press ->	
-------------------------	---

Press softkey to restart ->	
-----------------------------	---

- 1 Check the current reference size which is indicated on the soft key  (Ref N var).
- 2 If necessary, change the reference size, see Counting section.
- 3 Press the prompt soft key.
 - ➔ In the soft key line the instructions for the first step are displayed.
- 4 Load the tare weight and confirm with the indicated soft key.
 - ➔ In the soft key line the instructions for the next step are displayed.
- 5 Load the reference parts and confirm with the indicated soft key.
 - ➔ The display unit changes to PCS and the soft key line changes.
- 6 Load the weighing samples and read the number of pieces.
- 7 To restart counting with a new reference, press the indicated soft key.
 - ➔ **Cleared** is displayed briefly before the first prompt is displayed again.
- 8 Repeat steps 4 to 7 for other references.
- 9 To leave piece counting, press **C**.
 - ➔ **Cleared** is displayed briefly.



If a printer is connected, each individual result can be printed out by pressing .

2.12.3 Sample/Tare

This prompt will guide you through piece counting with first determining the average piece weight and then taring.

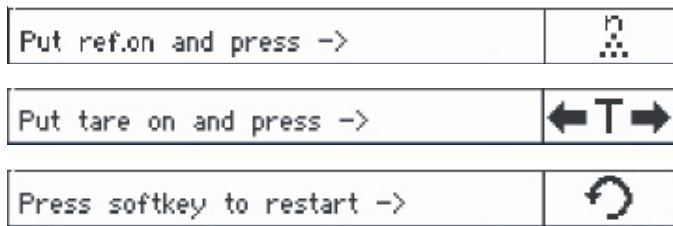

- 1 Check the current reference size which is indicated on the soft key  (Ref n var).
- 2 If necessary, change the reference size, see Counting section.
- 3 Press the prompt soft key.
 - ➔ In the soft key line the instructions for the first step are displayed.
- 4 Load the reference parts and confirm with the indicated soft key.
 - ➔ The display unit changes to PCS and the soft key line changes.
- 5 Load the tare weight and confirm with the indicated soft key.
 - ➔ In the soft key line the instructions for the next step are displayed.
- 6 Load the weighing samples and read the number of pieces.
- 7 To restart counting with a new reference, press the indicated soft key.
 - ➔ **Cleared** is displayed briefly before the first prompt is displayed again.
- 8 Repeat steps 4 to 7 for other references.
- 9 To leave piece counting, press **C**.
 - ➔ **Cleared** is displayed briefly.



If a printer is connected, each individual result can be printed out by pressing .

2.12.4 Hands free

This prompt will guide you through piece counting without pressing a key.

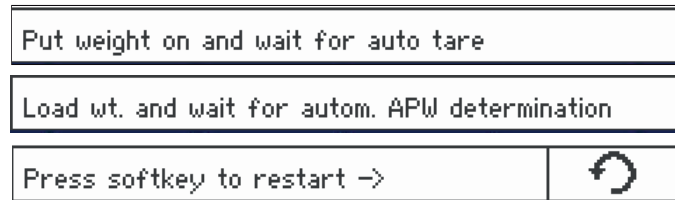

- 1 Press the prompt soft key.
 - ➔ In the soft key line the instructions for the first step are displayed.
- 2 Load the tare weight.
 - ➔ When the weight is stable, an automatic taring is carried out.
 - ➔ In the soft key line the instructions for the next step are displayed.
- 3 Load the indicated number of reference parts.
 - ➔ The average piece weight is determined automatically.
 - ➔ The weight unit changes to PCS and the soft key line changes.
- 4 Load the weighing samples and read the number of pieces.

Restarting piece counting

- To restart counting with a new reference, press the indicated soft key.
 - ➔ **Cleared** is displayed briefly before the first prompt is displayed again.

Leaving piece counting

- To leave piece counting, press **C**.
 - ➔ **Cleared** is displayed briefly.

2.12.5 Multi tare

This prompt will guide you through taring a bundle of containers with the same known tare weight.

- 1 Press the prompt soft key.
 - ➔ The number of containers (n) is highlighted.
- 2 Enter the number of containers and confirm entry with the soft key .
- 3 Enter the known tare weight of a single container and confirm entry with the soft key .
 - ➔ When all entries are made, the weight is shown in the display.
E.g., with a bundle of 6 containers of 0.4 kg each, a PT (preset tare) value of 2.4 kg is displayed for the whole bundle.
- 4 Weigh the bundle.
 - ➔ The net weight of the bundle is displayed without extra taring.
- 5 To leave prompting, press **C**.
 - ➔ **Cleared** is displayed briefly.

Enter number of containers:				
n:	0			
Enter value for each container:				
PT:	0.00	kg		
ESC				OK ✓

2.12.6 Additive tare

This prompt will guide you through taring, e.g., a pallet with containers of known tare weights.

- 1 Press the soft key **Prompt**.
 - ➔ A table for tare weights is displayed
- 2 Press the soft key **+**.
 - ➔ A window opens to enter the tare weight of the first container.
- 3 Enter the known tare weight and confirm with the soft key **OK**.
 - ➔ The first tare weight is entered in the table.
- 4 When all tare weights are entered, press **↵** to finish the entry.
 - ➔ The total of all tare weights is displayed as the pre-tare value indicated with PT.
- 5 Weigh the pallets.
 - ➔ The net weight of the pallet is displayed without extra taring.
- 6 To leave prompting, press **C**.
 - ➔ **Cleared** is displayed briefly.





S. No	Tare value	Unit

ESC **+** **OK** ✓

S. No	Tare value	Unit
1	1.20	kg

↑ ↓ **+** ✎ 🗑️

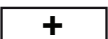
Soft key functions

Soft key	Meaning
	Selecting a tare weight
	
	Adding a tare weight
	Modifying a tare weight
	Deleting a tare weight

2.12.7 Take away

This prompt will guide you through weighing the same items into a container or weighing out of a container without pressing a key between the actions.

- 1 Press the prompt soft key.
 - ➔ The screen to enter target values is displayed.
 - 2 Enter target values as described in the Checkweighing section.
For weighing in, enter a positive target value. For weighing, out enter a negative target value.
 - ➔ **New target set!** is displayed briefly.
 - 3 For weighing in, place the empty container on the scale.
For weighing out, place the full container on the scale.
 - 4 Press →**T**← to tare the container.
 - 5 For weighing in, place the checkweighing material into the container.
For weighing out, remove the checkweighing material from the container.
 - ➔ If the applied/removed weight or the applied/removed amount is within the tolerance values, taring is carried out automatically.
The next item can be weighed in/removed.
 - 6 To leave prompting, press **C**.
 - ➔ **Cleared** is displayed briefly.
- i**
- When using an item which is too light or too heavy, taring must be carried out automatically.
 - Select the `Auto print` feature to generate an automatic printout when the weight is within or outside of tolerances.

2.13 Calling up alibi log file

If requested by national regulations, the optional Alibi memory is available to trace all weighing activities on the scale. Each printout is automatically stored in the Alibi memory with the mandatory data. Up to 300,000 data records can be stored in the optional Alibi memory.

In addition, you can store one more item, e.g., device name, device location or article number. Select the additional item in the menu under `Application -> Memory -> Custom field`.

- Press the soft key **Alibi**.
 - ➔ The alibi record of the last weighing is displayed.
 - ➔ In the example, the `Custom field` is set to `APW` (Average Piece Weight).

Memory				12/12
SNo. Scale		Net	8.21 kg	
Date	13/03/13	Tare	0.00 kg	
Time	14:25:35			
APW	0.005494 kg			
ESC				1/2

Soft key functions

Page	Soft key	Meaning
1	ESC	Leaving the Alibi memory
		Searching the Alibi memory
		To the next Alibi memory record
		To the previous Alibi memory record
2		Scroll the Alibi memory records forward in steps of 5
		Scroll the Alibi memory records backward in steps of 5
		To the first Alibi memory record
		To the last Alibi memory record



Searching is possible by all data fields, except the Custom field.

2.14 Cleaning



WARNING

Risk of electric shock

- 1 Before cleaning, unplug the power plug in order to disconnect the terminal from the power supply.
- 2 Cover open connectors with protective caps.

Cleaning of the ICS4_5 (dry environments)

- Clean the optional protective cover separately. The protective cover is dishwasher-safe.
- Take off the load plate and remove any dirt and foreign substances which may have collected underneath. Do not use any hard objects to prevent scratching the surface.
- Do not disassemble the weighing device.
- Remove any remaining detergent with a wet cloth.
- Observe all existing regulations on cleaning intervals and permissible cleaning agents.
- In case of a windshield, we recommend to clean it with a glass cleaner each day of usage in order to prolong the durability.

Cleaning of the ICS4_9 (wet environments)

These devices are designed to be used in a wet environment. Depending on the environment and the cleaning procedures, we suggest appropriate weighing platforms with different types of load cells. The following table provides a detailed overview of recommended environments and suitable cleaning procedures.

	Terminal	Weighing platform		
	ICS4_9	Standard aluminium potted load cell	Option potted stainless steel load cell	Option hermetically sealed stainless steel load cell
IP rating	IP68/ IP69k	IP65	IP65/IP67	IP68/IP69k
Environment				
Short time wet (30 min / day)	x	x	x	x
Part time wet (120 min/day)	x	–	x	x
Permanently wet	x	–	–	x
Cleaning procedure				
Wet wipe down	x	x	x	x
Light hose down < 5 l/min, 20 kPa	x	x	x	x
Light wash down < 12.5 l/min, 30 kPa	x	–	x	x
Heavy wash down, high pressure water and steam jet up to 10000 kPa	x	–	–	x
Cleaning detergents				
Mild detergents	x	x	x	x
Other detergents in accordance with the manufacturer's specifications and instructions	x	–	–	x

- Clean the optional protective cover separately. The protective cover is dishwasher-safe.
- Replace the protective cover regularly.
- Take off the load plate and remove any dirt and foreign substances which may have collected underneath. Do not use any hard objects to prevent scratching the surface.
- Do not disassemble the weighing device.
- Remove any remaining detergent by rinsing with clear water.
- To prolong the lifetime of the load cell, dry it with a soft lint-free cloth immediately after cleaning.
- Observe all existing regulations on cleaning intervals and permissible cleaning agents.

Cleaning of other weighing platforms not described in this user manual

- Make sure to observe the cleaning instructions for the connected weighing platform. The weighing platform may not be designed for the environments and cleaning procedures described above!

2.15 Verification test

The weighing instrument is verified if:

- the accuracy class is displayed in the metrological line,
- the approval readability is shown with "e = readability",
- it bears an official verification mark, e.g., the green M sticker (OIML),
- the validity is not expired.

The weighing instrument is also verified if:

- the metrological line shows "Approved scale",
- labels with the metrological data are placed near the weight display,
- the securing seal is not tampered with,
- it bears an official verification mark, e.g., the green M sticker (OIML),
- the validity is not expired.



The period of validity is country-specific. It is in the responsibility of the owner to renew verification in due time.







Strain gauge weighing platforms

Strain gauge weighing platforms use a Geo Code to compensate gravitational influence. The manufacturer of the weighing instrument uses a defined Geo Code value for verification.





- 1 Check if the Geo Code in the instrument corresponds with the Geo Code value defined for your location.
 - ➔ The Geo Code value is displayed when you switch on the instrument.
 - ➔ The Geo Code value for your location is shown in the Appendix.
- 2 Call the **METTLER TOLEDO** service technician if the Geo Code values do not match.

3 Counting

3.1 Counting parts into a container





- The soft keys `Ref N var` () and/or `Ref N fix` () are activated in the menu under `Terminal -> Device -> Keyboard -> Soft keys` (if not shown by default).
- 1 Place the empty container on the scale and press **→T←**.
 - ➔ The container is tared, the zero display and the symbol **NET** appear.
 - 2 Place the number of reference parts on the scale as indicated on the soft key  or  and press the corresponding soft key.
 - ➔ The scale determines the average piece weight and then shows the number of reference pieces.
 - 3 Add more parts to the container until the required number of pieces is reached.
 - 4 When piece counting is completed, press **C** to clear the reference.
 - ➔ The scale is ready for the next weighing or counting operation.
- 
 - The average piece weight remains saved until **C** is pressed or a new average piece weight is determined.
 - With  or soft key  (Weight count) you can switch between the number of pieces and the weighing units preset.
 - The average piece weight (APW), for example, the weight of an individual reference unit, can be displayed on the info page or in the auxiliary line.
 - If `Auto clear APW` is set to `On` in the menu under `Application -> Counting`, the average piece weight is automatically cleared after each counting operation.
 - The achieved counting accuracy can be displayed in the auxiliary line under `Terminal -> Device -> Display -> Auxiliary line`.

3.2 Counting parts out of a container

- The soft keys `Ref N var` () and/or `Ref N fix` () are activated in the menu under `Terminal -> Device -> Keyboard -> Soft keys` (if not shown by default).
- 1 Place the full container on the scale and press **→T←**.
 - ➔ The container is tared, the zero display and the symbol **NET** appear.
 - 2 Remove the number of reference parts out of the container as indicated on the soft key  or  and press the corresponding soft key.
 - ➔ The scale determines the average piece weight and then shows the number of reference pieces removed, together with a minus sign.
 - 3 Remove more parts out of the container until the required number of pieces is reached.
 - 4 When piece counting is completed, press **C** to clear the reference.
 - ➔ The scale is ready for the next weighing or counting operation.



3.3 Determining the parts in a full container

When you know the tare weight of the container, the number of parts in the container can be determined.







- The soft keys `Ref N var` () and/or `Ref N fix` () are activated in the menu under `Terminal -> Device -> Keyboard -> Soft keys` (if not shown by default).
- 1 Place the number of reference parts on the scale as indicated on the soft key  or  and press the corresponding soft key.
 - ➔ The scale determines the average piece weight and then shows the number of reference pieces.
- 2 Enter or scan with a barcode reader the known tare weight and press **→T←** to confirm.
 - ➔ The weight display shows the negative tare weight and the symbol **NET** appears.
- 3 Place the full container on the weighing platform.
 - ➔ The number of pieces in the container is displayed.

 If you already started counting an article and during the process you need to place a container with parts on the load plate, recall a pure tare article [Storing/recalling tare weights (pure tare articles) ▶ Page 20] after loading, then the scale takes automatically the tare weight and shows the correct quantity of the article. Furthermore, the counting procedure will not be interrupted.

3.4 Counting with a known average piece weight



- The soft key `APW` (Average Piece Weight, ) is activated in the menu under `Terminal -> Device -> Keyboard -> Soft keys` (if not shown by default).
- Enter the known average piece weight and press the soft key .
- ➔ The scale changes the unit to PCS.

The rest of the counting procedure is as described in [Counting parts into a container ▶ Page 35].

 **ICS445** and **ICS449**: To enter the average piece weight use soft key  to open entry and soft keys , , ,  to enter the average piece weight.

3.5 Changing reference quantity



3.5.1 Free reference quantity

- The soft key `Ref N var` () is activated in the menu under `Terminal -> Device -> Keyboard -> Soft keys`.
- In the `Application -> Counting` menu, `Fixed ref. size` is set to `Off`.
- 1 Place any number of reference parts on the scale.
- 2 Enter the number of reference parts and press the soft key .
- ➔ The scale determines the average piece weight and then shows the number of pieces. In the soft key  the new number of reference parts is indicated.

The rest of the counting procedure is as described in [Counting parts into a container ▶ Page 35].

3.5.2 Selecting reference quantity out of a set



With soft key  the following set of reference quantities is available: 5, 10, 20, 50, 100.

- The soft key `Ref N fix ()` is activated in the menu under `Terminal -> Device -> Keyboard -> Soft keys`.
- 1 Place the desired number of reference parts (5, 10, 20, 50, 100) on the scale.
 - 2 Press and hold the soft key  until the soft key line changes.
 - 3 Press the soft key for the desired number of reference parts.
 - ➔ The scale determines the average piece weight and then shows the number of pieces.
 - ➔ In the soft key  the new number of reference parts is indicated.

The rest of the counting procedure is as described in [Counting parts into a container ▶ Page 35].

3.6 Counting with reference weight check

The reference weight check ensures that the reference weight is high enough to lead to a good counting result.

- At least one of the soft keys `Ref N var ()`, `Ref N fix ()` or `APW ()` is activated in the menu under `Terminal -> Device -> Keyboard -> Soft keys`.
 - `Ref. weight check` is set to `On` under `Application -> Counting`.
- 1 Determine the average piece weight as described in "[Counting parts into a container ▶ Page 35]"
 - ➔ If the average piece weight is not sufficient, **Add x PCS** appears.
 - 2 Add the displayed number of pieces.
 - ➔ The average piece weight is determined again with the larger reference quantity.

The rest of the counting procedure is as described in "[Counting parts into a container ▶ Page 35]".







The tolerance for the reference weight check can be modified in the menu under `Application -> Counting -> Ref. weight -> Ref. weight check`.

3.7 Reference optimization

3.7.1 Automatic reference optimization





The greater the reference quantity, the more accurately the scale determines the number of pieces.

- The soft keys `Ref N var` () and/or `Ref N fix` () are activated in the menu under `Terminal -> Device -> Keyboard -> Soft keys`.
 - In the `Application -> Counting` menu, APW optimization is set to `Auto`, the symbol  appears in the display.
- 1 Place the indicated number of reference parts on the scale and press the soft key  or .
 - 2 Place additional reference parts on the scale. The maximum for the additional reference parts cannot be larger than the original sample.
 - ➔ The scale automatically optimizes the average piece weight with the larger number of reference parts.

The rest of the counting procedure is as described in [Counting parts into a container ▶ Page 35].

3.7.2 Manual reference optimization

The greater the reference quantity, the more accurately the scale determines the number of pieces.

- The soft keys `Ref N var` () and/or `Ref N fix` () are activated in the menu under `Terminal -> Device -> Keyboard -> Soft keys`.
 - In the `Application -> Counting` menu, APW optimization is set to `Soft key`.
 - In the `Terminal -> Device -> Keyboard -> Soft keys` menu, the soft key `APW optimization` is activated.
- 1 Place the indicated number of reference parts on the scale and press the soft key  or .
 - 2 Place additional reference parts on the scale and press soft key .
- ➔ The scale automatically optimizes the average piece weight with the larger number of reference parts.
- The rest of the counting procedure is as described in [Counting parts into a container ▶ Page 35].

3.8 Counting with automatic reference determination

- In the `Application -> Counting` menu, `Autosampling` is set to `On`.
- Place the indicated number of reference parts on the scale.
 - ➔ The scale automatically determines the average piece weight and then shows the quantity.

The rest of the counting procedure is as described in [Counting parts into a container ▶ Page 35].

 Pressing the soft key  (`Ref n VAR`) or  (`Ref n FIX`), the last average piece weight is cleared and the current weight is set as the new reference weight.

3.9 Counting with reference and bulk scale





3.9.1 Weighing systems with two scales

ICS4_5 / ICS4_9 can handle a weighing system with 2 scales.

There are two possibilities for counting with a scale system:



- Counting with **reference scale** and **bulk scale**:
e.g., a high precision scale for determining the reference and a floor scale for counting large quantities.
- Counting with **auxiliary scales**:
e.g., a high precision scale for counting small parts and a floor scale for counting bigger parts.

3.9.2 Counting with reference and bulk scale

- At least one of the soft keys Ref N var (), Ref N fix () or APW () is activated under Terminal -> Device -> Keyboard -> Soft keys.
 - In the Application -> Counting -> Counting system menu, one scale is configured as Reference scale for determining the average piece weight and the other scale is configured as Bulk scale for counting large numbers of pieces.
- 1 Place the indicated number of reference parts on the **reference scale** and press the soft key  or .
 - ➔ After determining the average piece weight the scale is automatically switched to the bulk scale.
 - 2 Place the empty container on the bulk scale and press **→T←**.
 - ➔ The container is tared and the zero display appears.
 - 3 Add the parts to the container until the required number of pieces is reached.

 Depending on the setting for Total count under Application -> Counting -> Counting system, the bulk scale will show either the number of pieces on the bulk scale only or the sum of pieces on both reference and bulk scale.

3.9.3 Counting with auxiliary scales





- At least one of the soft keys Ref N var (), Ref N fix () or APW () is activated in the menu under Terminal -> Device -> Keyboard -> Soft keys.
 - In the Application -> Counting -> Counting system menu, at least one scale of the system is configured as Auxiliary scale.
 - In the Terminal -> Device -> Keyboard -> Soft keys menu, the soft key Switch scale is activated.
- 1 Make sure that the selected scale is suitable for the product to be counted.
 - 2 Carry out counting as described in [Counting parts into a container ▶ Page 35].





 When changing the product to be counted, always check which of the auxiliary scales is the most suitable. If necessary, change the scale.

3.10 Counting by calling up an article from the database

3.10.1 Storing an article in the database

i The software tool METTLER TOLEDO Data+ offers the possibility to define articles on a PC and to transfer this information to the database of the weighing terminal, see www.mt.com/DataPlus.

- At least one of the soft keys Ref N var () , Ref N fix () or APW () is activated in the menu under Terminal -> Device -> Keyboard -> Soft keys.
- The soft key Save article () is activated in the menu under Terminal -> Device -> Keyboard -> Soft keys.







- 1 Place the indicated number of reference parts on the **reference scale** and press the soft key  or .
- 2 Press the soft key .
 - ➔ A new screen is displayed to enter an article.
- 3 Enter the article and confirm with the soft key .
 - ➔ **Record stored** is displayed briefly. The article is stored.



i

- If the Description field is activated in the Application -> Database menu, you are able to enter an article description as well.
- When you always use the same container, the tare weight can be saved with the article. Just tare the container before determining the reference.
- If the selected article already exists, the message **Article already exists – Overwrite article?** is displayed.

3.10.2 Recalling an article from the database using a soft key

- The soft key Load article () is activated in the menu under Terminal -> Device -> Keyboard -> Soft keys.

- 1 Press the soft key .
 - ➔ The database opens. The article data of the first database record are displayed.
 - ➔ For a counting article, the fields on the left side are significant.
- 2 Use the soft keys  /  to navigate through the database records. On the second soft key page, the soft keys  and  are available to scroll in steps of 5.
- 3 Confirm the selected data record with the soft key .
 - ➔ **Record loaded** is displayed briefly.
 - With a counting article, the weight unit changes to PCS.

Database				1/3
Article :	#	Tol type :	Absolute	
Desc. :		T- :	5.00 kg	
Tare :	0.00 kg	T :	5.50 kg	
APW :	0.00 kg	T* :	6.00 kg	
ESC			OK 	

3.10.3 Recalling an article from the database with a barcode reader

- If a barcode reader is connected to the weighing terminal via RS232 (COMx) or via USB Host (COM2), refer to the barcode reader documentation.
- The relevant COM port is configured as external input (`Communication -> COMx -> Mode -> External input`).
- The destination of the external input is configured as article (`Communication -> COMx -> External input -> Destination`).
- Scan the barcode with the barcode reader.
 - ➔ The article data are loaded.

3.10.4 Recalling an article from the database by entering the article number

 This function is only available with **ICS465** and **ICS469**.

- If you know the article number, just enter the article number and press the soft key .

4 Over/Under Checkweighing

4.1 Overview

The devices offer Over/Under Checkweighing functions. The respective settings in the menu are described in the Application -> Over/Under menu section.

The correspondingly colored background lighting allows rapid detection of the status "too light" (factory setting: red), "good" (factory setting: green) and "too heavy" (factory setting: yellow). The colors can be modified in the menu.

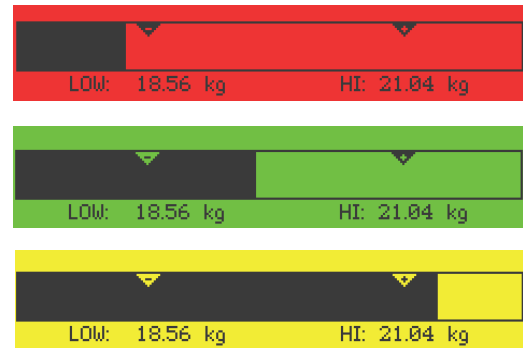

- The colored background lighting is only available for **ICS449**, **ICS465**, **ICS469**.
- In the following, Over/Under Checkweighing is described with the color display.





Tolerance types

Different entries are required at the beginning of Over/Under Checkweighing / Checkcounting, depending on the tolerance type setting.





- Absolute** A low and a high weight value must be entered. These weights and all weights within this range are treated as being within tolerance.
- Relative** Target weight (Target) as well as lower tolerance (Tol-) and upper tolerance (Tol+) have to be specified. The tolerances are displayed as relative deviations from the target weight.
- Percent** Target weight (Target) as well as lower tolerance (Tol-) and upper tolerance (Tol+) have to be specified. At Over/Under Checkweighing the weight value is represented as a percentage of the target weight. The target weight value is 100 % or 0 % at Over/Under Checkweighing to zero.

4.2 Specifying target values for Over/Under Checkweighing





- The soft key **Over/Under** () is activated in the menu under **Terminal** -> **Device** -> **Keyboard** -> **Soft keys** (if not shown by default).



- 1 Press the soft key .
 - ➔ The current Over/Under Checkweighing parameters are displayed.
- 2 Check the tolerance type.
- 3 To change the tolerance type press the soft key .
- 4 Confirm the tolerance type with the soft key .
- 5 Load the requested weight or enter the weight value and confirm with the soft key .
 - ➔ The next weight is highlighted.
- 6 Repeat step 5 until **New target set** is displayed.
 - ➔ The Over/Under Checkweighing display appears, the scale is ready for Over/Under Checkweighing.



- If tolerance default values have been set in the menu, only the target has to be specified with tolerance types "Relative" and "Percent".
- The upper tolerance value has to be greater than or equal to the lower one (High >= Low) or, respectively, the target weight has to be greater than or equal to the lower tolerance value and smaller than or equal to the upper tolerance (Tol+ >= Target >= Tol-).
- **ICS445** and **ICS449**: To enter target values use soft key  to open entry and soft keys , , ,  to enter the target values.

4.3 Specifying target number of pieces for Over/Under Checkcounting

- The soft key **Over/Under** () is activated in the menu under **Terminal** -> **Device** -> **Keyboard** -> **Soft keys** (if not shown by default).
- At least one of the counting soft keys **Ref N VAR** () , **Ref N FIX** () or **APW** () is activated in the **Terminal** menu.

- 1 To determine the average piece weight, apply the indicated number of reference parts as indicated on the soft key  or  and press the corresponding soft key.
 - ➔ The number of reference parts is displayed.
- 2 To determine the target number of pieces, proceed as described in the previous section.
 - ➔ The display unit is PCS.



- For alternate procedures to determine the average piece weight, refer to the Counting section.
- When using the unit PCS, the tolerance type Percent is not available.
- Once the target values are specified, the Over/Under Checkcounting procedures are the same as the Over/Under Checkweighing procedures.

4.4 Over/Under Checkweighing or Checkcounting procedure

The devices facilitate Over/Under Checkweighing and Checkcounting through differently colored background lighting for the status "too light" (factory setting: red), "good" (factory setting: green) and "too heavy" (factory setting: yellow).

- 1 Specify the target values as described in the previous sections.
- 2 Place the Over/Under Checkweighing or Checkcounting material on the scale.
 - ➔ Depending on the applied weight, the color of the background lighting changes. Weight information is displayed in accordance with the display setting and the Over/Under Checkweighing settings.

Tolerance type "Absolute"



Tolerance type "Relative"



Tolerance type "Percent"



- i** If you already started checkweighing an article and during the process you need to place a container with parts on the load plate, recall a pure tare article [Storing/recalling tare weights (pure tare articles) ▶ Page 20] after loading, then the scale takes automatically the tare weight and shows the correct quantity of the article. Furthermore, the checkweighing procedure will not be interrupted.

4.5 Over/Under Checkweighing during subtractive weighing

Assistance through the colored background and the graphical weighing aid is also possible during subtractive weighing and subtractive counting.

- 1 Specify target values as described in [Specifying target values for Over/Under Checkweighing ▶ Page 43]Specifying target values for Over/Under Checkweighing or Filling.
 - ➔ The target value is indicated with a negative sign.
- 2 Place a full container on the weighing platform and tare it.
- 3 Remove as much from the weighing sample as required for the display to change to the status "good" (factory setting = green).
- 4 Tare the unit again.
 - ➔ The scale is ready for the next removal.

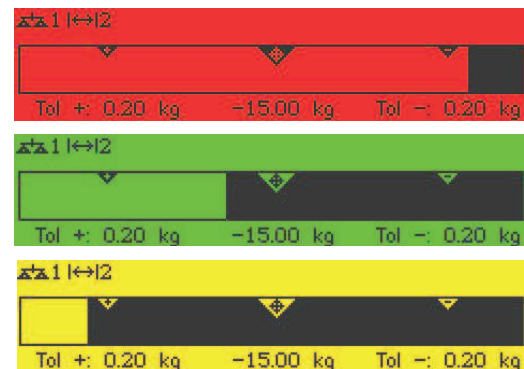



4.6 Over/Under Checkweighing with "Quick start"

If default values for the tolerances are used with tolerance types "Relative" or "Percent", Over/Under Checkweighing can be started by pressing just one key.

- The setting `On` is selected in the menu under `Application -> Over/Under -> Default Values`.
- Tolerance values are defined under `Application -> Over/Under -> Default Values`.
- The selected tolerance type matches the entered default values.
- Place the target weight or target amount on the scale and press the soft key 
 - ➔ The applied weight or the applied amount is stored as the target weight or target amount respectively. The display changes to the status "good" (factory setting = green). Over/Under Checkweighing is activated.

4.7 Over/Under Checkweighing to zero

The weight value or the number of pieces can also be represented as the difference to the target weight.

- For Over/Under Checkweighing to zero, tolerance types **Relative** or **Percent** are selected.
 - For Checkcounting to zero, tolerance type **Relative** is selected.
 - The soft key `To zero` () is activated in the `Terminal` menu, the symbol is displayed in the symbols and info line.
- 1 Specify the target values as described in the previous sections.
 - 2 Press the soft key .
 - ➔ The target is displayed with a minus sign.
 - 3 Place the Over/Under Checkweighing material on the scale.
 - ➔ Depending on the applied weight or the applied amount the color of the background lighting changes.
 - ➔ The display value is displayed in accordance with the tolerance type setting.
 - ➔ The target value is 0 (kg or PCS) or 0.00 %.



* -2.00 kg





* 0.01 kg



* 0.99 kg

Terminating Over/Under Checkweighing to zero



- Press soft key  again.
 - ➔ The symbol  in the info line disappears, the net weight is displayed.

4.8 Over/Under Checkweighing by calling up an article from the database

4.8.1 Storing an article in the database

i The software tool METTLER TOLEDO Data+ offers the possibility to define articles on a PC and to transfer this information to the database of the weighing terminal, see www.mt.com/DataPlus.

- The soft key **Save article** () is activated in the menu under `Terminal -> Device -> Keyboard -> Soft keys`.







- 1 Determine the target as described in the previous sections.
- 2 Press the soft key .
 - ➔ A new screen is displayed to enter an article. Capital letters are active.
- 3 Enter the article and confirm with the soft key .
 - ➔ **Record stored** is displayed briefly. The article is stored.



i

- If the `Description` field is activated in the `Application -> Database` menu, you are able to enter an article description as well.
- When you always use the same container, the tare weight can be saved with the article. Just tare the container before determining the target.
- If the selected article already exists, the message **Article already exists – Overwrite article?** is displayed.

4.8.2 Recalling an article from the database using a soft key

- The soft key **Load article** () is activated in the menu under `Terminal -> Device -> Keyboard -> Soft keys`.

- 1 Press the soft key .
 - ➔ The database opens. The article data of the first database record are displayed.
 - ➔ For an Over/Under Checkweighing article the fields on the right side are significant.
- 2 Use the soft keys  /  to navigate through the database records. On the second soft key page, the soft keys  and  are available to scroll in steps of 5.
- 3 Confirm the selected data record with the soft key .
 - ➔ **Record loaded** is displayed briefly. The colored Over/Under Checkweighing display appears.

Database				1/3
Article :	#	Tol type :	Absolute	
Desc. :		T- :	5.00 kg	
Tare :	0.00 kg	T :	5.50 kg	
APW :	0.00 kg	T* :	6.00 kg	
ESC			OK 	

4.8.3 Recalling an article from the database with a barcode reader

- If a barcode reader is connected to the weighing terminal via RS232 (COMx) or via USB Host (COM2), refer to the barcode reader documentation.
- The relevant COM port is configured as external input (`Communication -> COMx -> Mode -> External input`).
- The destination of the external input is configured as article (`Communication -> COMx -> External input -> Destination`).
- Scan the barcode with the barcode reader.
 - ➔ The article data are loaded.

4.8.4 Recalling an article from the database by entering the article number



This function is only available with **ICS465** and **ICS469**.



- If you know the article number, just enter the article number and press the soft key .

4.9 Leaving Over/Under Checkweighing

With clearing the Over/Under Checkweighing parameters

- Press **C**.
 - ➔ **Cleared** appears in the display.
 - ➔ The target values are cleared and the straight weighing display appears.
 - ➔ The device operates in straight weighing mode.

With keeping the Over/Under checkweighing parameters

- 1 Press the soft key .
 - ➔ The straight weighing display appears, the Over/Under Checkweighing parameters are kept.
 - ➔ The device operates in straight weighing mode.
- 2 To reactivate the Over/Under Checkweighing parameters, press the soft key .
 - ➔ The most recently entered Over/Under Checkweighing parameters are displayed.

5 Totalization

5.1 Totalizing manually

Starting totalization

- Press the soft key Σ .
- ➔ The following soft keys for totalizing are displayed.

Soft key	Meaning
ESC	Leave totalizing without clearing the sum
+	Add item to the sum
	Undo totalization
-	Add item to the negative sum

Totalizing

- 1 Load the first sample and press the soft key **+**.
 - ➔ Total Net, Total Gross and number of items are displayed.
- 2 Unload the scale.
- 3 Load the next sample and press the soft key **+** again.
 - ➔ The totals are updated.
- 4 Unload the scale.
- 5 Repeat steps 3 and 4 for further items.
- 6 To finish totalizing, press **C**.
 - ➔ The total is cleared.

- i** • Piece counting results and Over/Under Checkweighing results can be totalized the same way, but they cannot be mixed up in one totalizing action.
- If you already started totalizing an article and during the process you need to place a container with parts on the load plate, recall a pure tare article [Storing/recalling tare weights (pure tare articles) ▶ Page 20] after loading, then the scale takes automatically the tare weight and shows the correct quantity of the article. Furthermore, the totalizing procedure will not be interrupted.

Totalizing in subtractive weighing

- 1 Load the full container and press **→T←**.
 - ➔ The full container is tared.
- 2 Remove the first portion from the container and press the soft key **-**.
 - ➔ Total Net, Total Gross and number of items are displayed.
- 3 Press **→T←**.
- 4 Remove the next portion and press the soft key **-** again.
 - ➔ The total is updated.
- 5 Repeat steps 3 and 4 for further portions.
- 6 To finish totalizing, press **C**.
 - ➔ The total is cleared.

- i** Piece counting results and Over/Under Checkweighing results can be totalized the same way, but they cannot be mixed up in one totalizing action.

5.2 Automatic totalizing

The automatic mode facilitates the totalizing process. After putting the load on the scale, the weight value is added automatically.

■ `Auto+` or `Auto-` is selected in the menu under `Application -> Totalizing -> Mode`.

- 1 Press the soft key Σ .
- 2 Load the first sample.
 - ➔ The total is displayed in the auxiliary lines.
- 3 Unload the scale.
- 4 Load the next sample.
 - ➔ The total is updated.
- 5 Repeat steps 3 and 4 for further items.
- 6 To finish totalizing, press **C**.
 - ➔ The total is cleared.



- Piece counting results and Over/Under Checkweighing results can be totalized the same way.
- To avoid weighing a sample twice, the `Zero return` function can be enabled in the menu under `Application -> Totalizing`. A stable zero must be reached between two samples.

5.3 Deleting items from the sum

- Press the soft key \cup .
 - ➔ The last weighing is deleted from the sum.

5.4 Terminating totalizing

With clearing the total

- Press **C**.
 - ➔ **Cleared** appears in the display.
 - ➔ The total is cleared and the straight weighing display appears.
 - ➔ The device operates in straight weighing mode.

With keeping the total

- 1 Press the soft key **ESC**.
 - ➔ The straight weighing display appears, the total is kept.
 - ➔ The device operates in straight weighing mode.
- 2 To continue totalizing, press the soft key Σ .
 - ➔ The last total is displayed.

6 Settings in the menu

6.1 Menu overview

In the menu, settings can be changed and functions can be activated. This enables adaptation to individual weighing requirements.

The menu consists of the following 5 main blocks containing various submenus on several levels which are described in the following sections.



- Scale
- Application
- Terminal
- Communication
- Maintenance

6.2 Operating the menu



6.2.1 Calling up the menu and entering the password

The menu differentiates between 2 operating levels: Operator and Supervisor. The Supervisor level can be protected by a password. When the device is delivered, both levels are accessible without a password.

Operator menu

- 1 Press  and keep it pressed until **Enter code** appears.
- 2 Press  again.
 - ➔ The menu item `Terminal` is displayed. Only parts of the submenu `Device` are accessible.

Supervisor menu

- 1 Press  and keep it pressed until **Enter code** appears.
 - 2 Enter the password and confirm with .
- ➔ The first menu item `Scale` is highlighted.



- By default, no password is set. Therefore, confirm the password inquiry with  when you call up the menu for the first time.
- As long as no supervisor password is defined, operator access will offer the complete supervisor menu.
- If a password is not entered within a few seconds, the scale returns to the weighing mode.
- If a password has been issued for supervisor access to the menu and you have forgotten it, please contact the **METTLER TOLEDO** service.



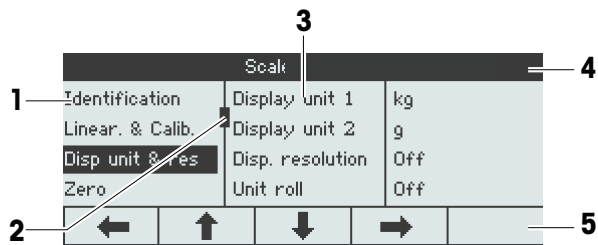

6.2.2 Display in the menu

Menu items are displayed together with their context.



- 1 Menu items; the selected menu item is highlighted
- 2 Scroll flag, like, e.g., the scroll bar of your PC
- 3 Sub-menu items
- 4 Menu info line, i.e., menu path of the current menu item
- 5 Navigation info line: use the keys below to navigate the menu as indicated

Exiting the menu

- Press .
 - Press the key  to save the menu changes and to return to the weighing mode.
- or
- Press the key  for further menu settings.
- or
- Press the key  to discard changes and return to the weighing mode.

6.2.3 Selecting and setting parameters in the menu

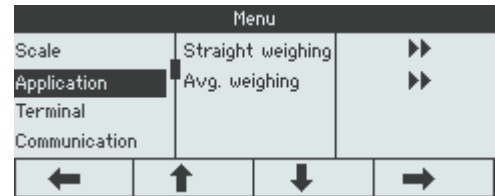

Example: Setting the average weighing mode to "Automatic"

- 1 In the menu start screen use  to select (highlight) the `Application` menu.
The submenus are displayed in the middle column.

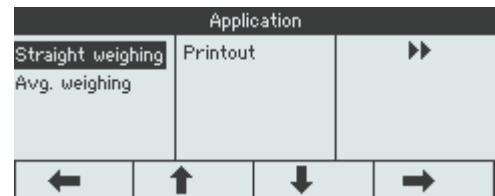

- 2 Press  to enter the `Application` menu.



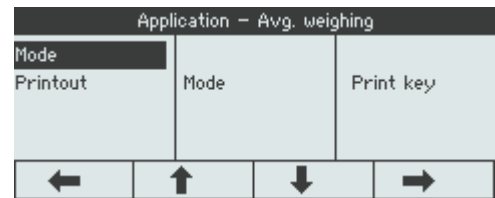

- 3 Press  and then press  to open the `Avg. weighing` submenu.
The current setting of the highlighted menu item is displayed in the right column.



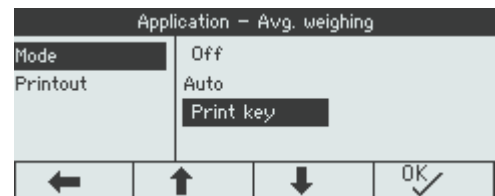

- 4 Press  to enter the `Mode` submenu.
The possible settings of the selected menu item are displayed on the right side.

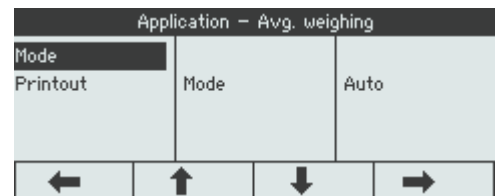

- 5 Press  to select (highlight) `Auto` and confirm selection with .
- The setting of the average weighing mode has changed.



-  Should the settings of a menu item not be displayed on one page (e.g., all the info items), use  to proceed to the hidden items.

6.3 Scale menu block

6.3.1 Scale menu overview

The `scale` menu depends on the connected load cell which is indicated on the type label.

Type	Load cell	Scale menu
ICS4_5g / ICS4_9g	Analog	[Analog scale menu ▶ Page 54]
ICS4_5i / ICS4_9i	IDNet	[IDNet scale menu block ▶ Page 59]
ICS4_5s / ICS4_9s	SICSpro	[Analog scale menu ▶ Page 54]
ICS4_5k-.../f	MonoBloc®	[Analog scale menu ▶ Page 54]



- When entering the `scale` menu block, an overview of the connected scales is displayed.
- After selecting Scale 1 or Scale 2, the `scale` menu is available.
- If Scale 2 is a SICS scale, no further settings are available.

6.3.2 Scale menu block (Analog / SICSpro)

Overview

Factory settings are printed in **bold** in the following overview.

Level 1	Level 2	Level 3	Level 4
Identification	Serial no. scale, Scale model, Scale location, Scale ID		
Linear. & Calib.	Last calibration		
	Start up FACT (for ICS4_5k-.../f compact scales only)	On , Off	
	Auto print calib.	On , Off	
	Perform calib.		
Disp. unit & res.	Display unit 1	g, kg , oz, lb, lb-oz, t	
	Display unit 2	g , kg, oz, lb, lb-oz, t	
	Disp. resolution		
	Unit roll	On, Off	
Zero	AZM	Off, 0.5d , 1d, 2d, 5d, 10d	
Tare	Auto tare	On, Off	
	Chain tare	On , Off	
	Auto clear tare	On, Off	
Restart	On, Off		
Filter	Vibration	Low, Medium , High	
	Process	Universal , Dosing, Absolute	
	Stability	Fast, Standard , Precise	
MinWeigh	MinWeigh	On, Off	
	Display color (not for ICS445)	White, Yellow, Red , Green, Blue, Violet, Dark blue, Grey	
FACT (for ICS4_5k-.../f compact scales only)	Temperature	Off, 1K, 2K, 3K	
	Time	Time 1, Time 2, Time 3	
	Days	Monday ... Sunday	Off , On
Reset	Perform reset?		

Description

Identification	Displaying/setting scale identification data
Serial no. scale	Displaying the serial number of the weighing platform
Scale model	Displaying the scale type, e.g., PBD555 Available for METTLER TOLEDO scales only
Scale location	Entering the scale location, e.g., floor and room
Scale ID	Entering the scale identification, e.g., inventory number
Notes	<ul style="list-style-type: none"> Scale location and Scale ID can be displayed in the auxiliary or info lines or printed out. Scale location and Scale ID can consist of up to 24 alphanumeric characters.

Linear. & Calib	Linearization and calibration
Last calibration	Shows the date of the last calibration.
Start up FACT	When set to On , an internal calibration is performed every time the scale is switched on. It is recommended not to disable this setting if the scale will be moved to other locations.
Autoprint calib.	When set to On , a protocol is printed out automatically for each calibration process.
Perform calib.	<p>Important: With ICS4_5k-.../f weighing terminals make sure that the scale has been switched on at least 15 minutes before performing linearization/calibration.</p> <ol style="list-style-type: none"> Start calibration with <input type="button" value="OK✓"/>. ⇒ Preload is blinking. Ensure that the weighing platform is empty and confirm with <input type="button" value="OK✓"/>. ⇒ xx kg is blinking. If necessary, change the calibration weight value displayed using <input type="button" value="↓"/> / <input type="button" value="↑"/>. Put on the indicated calibration weight on the weighing platform and confirm with <input type="button" value="OK✓"/>. ⇒ Preload is blinking. Remove the calibration weight and confirm with <input type="button" value="OK✓"/>. ⇒ Passed is displayed briefly.
Notes	<ul style="list-style-type: none"> In order to achieve a particularly high precision, calibrate under full load. The calibration process can be aborted using <input type="button" value="ESC"/>. This menu item is not available for verified scales.

Disp. unit & res.	Display units and resolution
Display unit 1	Selecting weighing unit 1
Display unit 2	Selecting weighing unit 2, different from unit 1
Display resolution	Selecting readability (resolution). The possible settings depend on the connected scale. When set to <i>off</i> , only the default resolution of the weighing platform is available.
Unit roll	When set to <i>on</i> , the weight value can be displayed in all available units with  .
Notes	<ul style="list-style-type: none"> In case of verified scales, individual sub-items of the <i>Display/Units & Resolution</i> menu item may not be available or only to a limited extent, depending on the respective country. On dual-range/dual interval scales, resolutions marked with I<->I 1/2 are divided into 2 weighing ranges/intervals, e.g., 2 x 3000 d. On triple-range/multi interval scales, resolutions marked with I<->I 1/2/3 are divided into 3 weighing ranges/intervals, e.g., 3 x 3000 d.

Zero	Automatic zero setting
AZM	Automatic Zero Maintenance
On/Off	Switching automatic zero maintenance on/off.
Off; 0.5 d; 1 d; 2 d; 5 d; 10 d	Selecting zeroing range in digits per second.
Note	On verified scales, this menu item does not appear.

Tare	Tare function
Auto tare	Switching on/off automatic taring <i>Auto tare = On</i> : When a load is placed on the scale and the gross weight exceeds 9 d, the weight is tared automatically.
Chain tare	Switching on/off chain tare <i>Chain tare = On</i> : It is possible to tare several times if, e.g., cardboard is placed between individual layers in a container.
Auto clear tare	Switching on/off automatic clearing of the tare weight <i>Auto clear tare = On</i> : When the load is removed and the weight drops below 9 d, the tare weight is cleared automatically.

Restart	Automatic saving of zero point and tare value
Restart	When set to <i>on</i> , the last zero point and the tare value are saved. After switching off/on or after a power interruption, the device continues to work with the saved zero point and tare value.

Filter	Filter settings
Vibration	Adaptation to ambient conditions
Low	Very steady and stable environment. The scale works very rapidly, but is very sensitive to external influences.
Medium	Normal environment. The scale operates at medium speed.
High	Unstable environment. The scale works more slowly, but is less sensitive to external influences.
Process	Adaptation to the weighing process
Universal	Universal setting for all weighing samples and normal weighing goods.
Dosing	Dispensing liquid or powdery weighing samples (only for certain weighing platforms, e.g., PBK9-series / PFK9-series).
Absolute	For solid bodies under extreme conditions, e.g., strong vibrations.
Stability	Adjusting the stability detector
	The slower the scale works, the greater the reproducibility of the weighing results.
Fast	The scale operates very fast.
Standard	The scale operates at medium speed.
Precise	The scale operates with the greatest possible reproducibility.

MinWeigh	MinWeigh function
MinWeigh	Switching MinWeigh function on/off When set to On and if the weight on the scale drops below the stored minimum weight,  will appear in the symbols and info line and the display color will change.
Display color	Setting the display color for weight values below the stored minimum weight. Not for ICS445 .
Note	Before you can use this function, the METTLER TOLEDO service technician has to determine and enter a minimum weight value.

FACT	Fully automatic calibration test (for ICS4_5k-.../f compact scales only)
Temperature	Setting the temperature difference for automatic adjustment.
Off	Switching off automatic adjustment in case of a temperature difference.
1K, 2K, 3K	Automatic adjustment in case of the selected temperature change.
Time	Setting up to 3 times per day for automatic adjustment.
Time 1, Time 2, Time 3	Entering the times for the automatic adjustment (hours, minutes in 24 h format). To deactivate Time 2 and Time 3, set them to 00:00:00.
Days	Setting the days of the week for automatic adjustment.
Monday ... Sunday	On all days which are set to On , the automatic adjustment will be performed.
Note	FACT is executed under the following conditions: <ul style="list-style-type: none"> No key has been pressed for 3 minutes. – and – The displayed weight value is smaller than 30 d and stable.

Reset	Resetting the scale settings to factory settings
Perform reset?	<p data-bbox="627 208 1214 236">– Confirm with <input type="checkbox"/> $\frac{0\%}{\checkmark}$ to reset the scale menu settings.</p> <p data-bbox="627 246 1038 276">For ICS4_5k-.../f compact scales only</p> <ol data-bbox="627 287 1166 400" style="list-style-type: none"> <li data-bbox="627 287 948 314">1 Press Reset for 5 seconds. <ul data-bbox="667 325 1086 353" style="list-style-type: none"> <li data-bbox="667 325 1086 353">➔ Reset User Calibration is displayed. <li data-bbox="627 363 1166 400">2 Confirm with <input type="checkbox"/> $\frac{0\%}{\checkmark}$ to reset the user calibration.

6.3.3 IDNet scale menu block

Overview

Level 1	Level 2	Level 3
Display unit & Resolution	Display unit 2	g , kg, oz, lb, t
	Unit roll	On, Off
Zero	AZM	Off, 0.5d , 1d, 2d, 5d, 10d
Tare	Auto tare	On, Off
	Auto clear tare	On, Off , 9 d
	Chain tare	On , Off
Restart	On, Off	
Filter	Vibration	Stable, Normal , Unstable
	Process	Finefill, Universal , Absolute
	Stability	ASD = 0, 1, 2 , 3, 4, 5
Update	The possible settings depend on the connected scale	
MinWeigh	Function	On, Off
	MinWeigh value	
	Display color (not for ICS445)	White, Yellow, Red , Green, Blue, Violet, Dark blue, Grey (not for ICS445)
Reset	Perform reset?	

Description

Identification	Displaying/setting scale identification data
Serial no. scale	Displaying the serial number of the weighing platform
Scale model	Displaying the scale type, e.g., PBD555 Available for METTLER TOLEDO scales only
Scale location	Entering the scale location, e.g., floor and room
Scale ID	Entering the scale identification, e.g., inventory number
Notes	<ul style="list-style-type: none"> Scale location and Scale ID can be displayed in the auxiliary or info lines or printed out. Scale location and Scale ID can consist of up to 24 alphanumeric characters.

Display unit & Resolution	Setting the weighing units
Unit 2	Selecting weighing unit 2, different from unit 1.
Unit roll	When set to On , the weight value can be displayed in all available units with  .
Notes	<ul style="list-style-type: none"> In case of verified scales, individual sub-items of the Display unit & Resolution menu item may not be available or only to a limited extent, depending on the respective country. On dual-range/dual interval scales, resolutions marked with 1<->1 1/2 are divided up into 2 weighing ranges/intervals, e.g., 2 x 3000 d. On triple-range/multi interval scales, resolutions marked with 1<->1 1/2/3 are divided up into 3 weighing ranges/intervals, e.g., 3 x 3000 d.

Zero	Automatic zero setting
AZM	Automatic Zero Maintenance
On/Off	Switching automatic zero maintenance on/off.
0.5d, 1d, 2d, 5d, 10d	Selecting the threshold for automatic zero setting.
Notes	<ul style="list-style-type: none"> On verified scales, this menu item does not appear. The effective range of the zero update mode can only be set by the METTLER TOLEDO service technician.

Tare	Tare function
Auto tare	Switching on/off automatic taring.
On	When a load is placed on the scale and the gross weight exceeds 9 d, the weight is tared automatically.
Off	No automatic taring.
Auto clear tare	Configuring the automatic clearing of the tare weight.
On	The tare weight is automatically cleared if the gross weight is 0 or below zero.
Off	No automatic clearing of the tare weight.
9 d	The tare weight is automatically cleared if the gross weight is within +/- 9 display steps.
Chain tare	Switching on/off chain tare.
On	It is possible to tare several times if, e.g., cardboard is placed between individual layers in a container.
Off	Taring is only possible once.

Restart	Automatic saving of zero point and tare value
Restart	When set to On , the last zero point and the tare value are saved. After switching off/on or after a power interruption, the device continues to work with the saved zero point and tare value.

Filter	Filter settings
Vibration	Adaptation to ambient conditions
Low	Very steady and stable environment. The scale works very rapidly, but is very sensitive to external influences.
Medium	Normal environment. The scale operates at medium speed.
High	Unstable environment. The scale works more slowly, but is insensitive to external influences.
Process	Adaptation to the weighing process
Dosing	Dispensing of liquid or powdered weighing samples manually.
Universal	Universal setting for all weighing samples and normal weighing goods.
Absolute	No adaptation, to perform automated filling processes, e.g., with PLC.
Stability	Adjusting the stability detector
	The slower the scale works, the greater the reproducibility of the weighing results.
ASD = 0	Stability detector switched off. Only possible for non-verified scales.
ASD = 1	Rapid display, good reproducibility
...	...
ASD = 4	Slow display, excellent reproducibility

Update	Setting the display speed of the weight display
xx UPS	Selecting the number of updates per second (UPS).
Notes	<ul style="list-style-type: none"> This menu is only displayed if the Update function is supported by the connected scale. The possible settings depend on the connected scale.

MinWeigh	MinWeigh function
MinWeigh	Switching MinWeigh function on/off When set to On and if the weight on the scale drops below the stored minimum weight,  will appear in the symbols and info line and the display color will change.
Display color	Setting the display color for weight values below the stored minimum weight. Not for ICS445 .
Note	Before you can use this function, the METTLER TOLEDO service technician has to determine and enter a minimum weight value.





Reset	Resetting the scale settings to factory settings
Perform reset?	– Confirm resetting with <input type="checkbox"/>  .

6.4 Application menu block

6.4.1 Application → Straight weighing

Printout	Defining printer and template in the straight weighing application
COM1, COM2	Selecting the COM port for the desired printer E.g., COM1 for printout to a PC and the optional COM2 for printout on an office (ASCII) printer
Off	No printout on this COM port
Standard	Printout with the standard template on the selected printer
Template 1 ... Template 5	Assigning a customer template to the selected printer
Notes	<ul style="list-style-type: none"> • Templates 1 ... 5 can be defined under <code>Communication -> Define templates</code>. • This menu item is only available if a COM port is set to Print mode. • There are 5 more templates available (Template 6 ... Template 10). Please ask your METTLER TOLEDO service technician to configure these templates or create them by yourself using the Data+ software (www.mt.com/DataPlus), if desired.

6.4.2 Application → Average weighing

Mode	Selecting mode for determining the average weight for an unstable load (dynamic weighing)
Auto	Calculating average weight with automatic start of the weighing cycle
Print key Info key Switch key Soft key	Calculating average weight with manual start of the weighing cycle via the selected key: Print key  , Info key  , Switch key  , Soft key 
Printout	Defining printer and template in the average weighing application
	See Application → Straight weighing

6.4.3 Application → Clever print



Clever print	Settings for printing without pressing a key
Activate	When set to <code>On</code> , the result is automatically printed when the weight between two weighings has dropped below the threshold.
Threshold	Enter threshold for unloading the scale between two weighings. Possible settings: 0.0 kg ... max. capacity Factory setting: 0.0 kg

6.4.4 Application → Counting

Overview

Level 1	Level 2	Level 3
Reference size		
Fixed ref. size	On, Off	
Ref. weight	Ref. wt. check	On, Off
	Ref. wt. value	0 % ... 2 % ... 30 %
APW optimization	Off , Auto, soft key	
Autosampling	On, Off	
Auto clear APW	On, Off	
Counting system	Scale 1	Bulk, Reference, Aux., Off
	Scale 2	
	Total count	Bulk , Bulk + Ref.
Printout	see Application → Straight weighing	

Description

Reference size	Defining a default reference size for soft key 
	E.g., when entering a reference size of 12 PCS, this reference size is displayed in the soft key  .

Fixed ref. size	Selecting the reference size
Off	Variable reference size, i.e., any number of parts can be used as reference size.
On	Determining the average piece weight is only possible with the default reference size.

Ref Weight	Monitoring the minimum reference weight
Ref wt check	Monitoring the minimum reference weight
Off	No monitoring of the minimum reference weight
On	Monitoring the minimum reference weight. When the reference weight drops below the set tolerance value, the display color changes and a message is displayed which asks you to add more reference parts.
Ref wt value	Setting the process tolerance for the reference weight check Only displayed if <code>Ref wt check</code> is set to <code>On</code> .
1 %, 2 % , ... 30 %	Setting the process tolerance for the reference weight check. The higher the process tolerance, the smaller the required minimum reference weight. Factory setting: 2 %

APW optimization	Optimization of the average piece weight
Off	No optimization of the average piece weight
Auto	Automatic optimization of the average piece weight
Soft key	Manual optimization of the average piece weight with soft key 

Autosampling	Automatic determination of the average piece weight
On	After taring, the average piece weight is determined with the next weight placed on the scale and the displayed reference size
Off	No automatic determination of the average piece weight

Auto clear APW	Automatic clearing of the average piece weight
On	When the load is removed from the scale after a counting operation, the average piece weight is automatically cleared. The next counting operation will begin with determining the average piece weight again.
Off	The average piece weight must be cleared manually with C .

Counting system	Configuring a system of several scales for counting
Scale 1, Scale 2	Selecting the scale to assign a function in the counting system. Only the scales connected are displayed.
Bulk	The selected scale serves as bulk scale to count/measure quantities. The other scale of the system must be set to <i>Reference</i> .
Reference	The selected scale serves as reference scale to determine the average piece/unit weight. The other scale of the system must be set to <i>Bulk</i> .
Aux.	The selected scale can be used for determining the average piece/unit weight as well as for counting/measuring.
Off	The selected scale is not part of a counting system.
Total count	Selecting the displayed number of pieces on the bulk scale
Bulk	Only the pieces on the bulk scale are displayed.
Bulk + Ref.	The pieces on the bulk scale and on the reference scale are displayed on the bulk scale.

Printout	Defining printer and template in the counting application
	See Application → Straight weighing.

6.4.5 Application → Over/Under

Overview

Level 1	Level 2	Level 3
Tolerance type	Off , Absolute, Relative, Percent	
Default values	Act. def. values	Off , On
	Rel. weight	Tol–, Tol+
	Per. weight	Tol–, Tol+
	Rel. pieces	Tol–, Tol+
Output	Thresh % of Tol–	0 ... 12 ... 100 %
	Beeper	Off , Within Tolerances, Outside Tolerances, Stable result
	Beeper mode	Stable result, Tolerance border
	Autoprint	Off , Within Tolerances, Outside Tolerances, Stable result
Display mode & Colors	Stealth mode	On, Off
	Good range	White, Yellow, Red, Green, Blue, Violet, Dark blue, Grey (not for ICS445)
	Under range	
	Over range	
	Below threshold	
Printout	See Application → Straight weighing	

Description

Tolerance type	Specifying which parameters have to be entered for Over/Under Checkweighing
Off	No tolerance type predefined. It can be set individually when entering Over/Under Checkweighing parameters.
Absolute	A low and a high weight value must be entered. These weights and all weights within this range are treated as being within tolerance.
Relative	The target weight has to be entered as an absolute weight, upper and lower tolerances as deviations in weight from the target weight.
Percent	The target weight has to be entered as an absolute weight, upper and lower tolerances as deviations in percent from the target weight. This setting is not available for counting.

Default values	Storing default tolerance values
Act. def. values	Activating/deactivating usage of default tolerance values.
Rel. weight	Entering the default values for Tolerance – and Tolerance +.
Per. weight	Entering the default percentages for Tolerance – and Tolerance +.
Rel. pcs	Entering the default values for Tolerance – and Tolerance + in pieces.
Note	When always using the same tolerances for Over/Under Checkweighing, store these tolerances to avoid entering tolerances all the time.

Output	Setting output options
Threshold as % of Tol-	<p>Threshold to determine at which weight the status of Tol- is indicated.</p> <p>To avoid Tol- being active at zero or a very low weight, you can define the "Threshold as % of Tol-".</p> <p>When Threshold as % of Tol- is reached, the colored display will change from the "Below threshold" color to the "Tolerance -" color.</p> <p>This feature can be used to show the "Tolerance -" color close to the target or as additional setpoint for I/O control.</p> <p>This setpoint is available on the optional digital I/O interface as well.</p> <p>Example: Target = 1000 g, Tol- = 100 g Threshold = x % * (Target - (Tol-)) Threshold = 12 % * (1000 g - 100 g) = 12 % * 900 g = 108 g In the example, the Tol- color is displayed for weights from 108 g up to 900 g.</p>
Beeper	Setting the beeper for Over/Under Checkweighing
Off	No beeper
Within tolerances	A short beep will sound when a weight value within the tolerance values is reached
Outside tolerances	A short beep will sound when a weight value outside the tolerance values is reached
Stable result	A short beep will sound when a stable result is reached
Beeper mode	Defining how the beeper will act
Stable result	Beeping only when a stable weight value within the selected range is recognized
Tolerance border	Beeping on every entering or leaving of the good range
Autoprint	Setting the automatic printout
Off	No automatic printout
Within tolerances	Automatic printout when a stable weight value within the tolerance values is reached
Outside tolerances	Automatic printout when a stable weight value outside the tolerance values is reached
Stable result	Automatic printout when a stable result is reached
Note	For the automatic printout, the communication port at which the printer is connected, must be configured as follows: COMx -> Mode -> Print (and not Auto Print!)

Display mode & colors	Setting the weight display in the Over/Under Checkweighing application
Stealth mode	This menu item is not available for approved scales. When set to On , there is no weight display, only the (colored) display for "too light", "good" and "too heavy".
Good range	Selecting the color to indicate a weight value within tolerances (not for ICS445) Factory setting: green
Under range	Selecting the color to indicate a weight value below "Tolerance -" (not for ICS445) Factory setting: red
Over range	Selecting the color to indicate a weight value above "Tolerance +" (not for ICS445) Factory setting: yellow
Below threshold	Selecting the color to indicate a weight value below "Threshold as % of Tol-" (not for ICS445) Factory setting: white

Printout	Defining printer and template in the Over/Under Checkweighing application
	See Application -> Straight weighing

6.4.6 Application → Totalizing

Overview

Level 1	Level 2	Level 3	Level 4
Mode	Mode	Manual , Auto +, Auto –	
	Zero return	Off , On	
Printout	Lot print	COM1, COM2	Off, Standard, Template 1 ... Template 10
	Final print		
	Summary print		

Description

Mode	Configuring totalizing
Mode	Selecting the totalizing mode
Manual	Items must be totalized manually with the soft key <input type="button" value="+"/>
Auto +	Stable weight values will be totalized automatically
Auto –	Automatic totalization of stable weight values in subtractive weighing
Zero return	Reaching a stable zero point between two items
On	All load must first be removed from the scale before totalization of the next item is possible
Off	No load removal requested between two items

Printout	Defining printer and template in the totalizing application
Lot print	Printout for each individual item
Final print	Printout of the total at the end of totalizing
Summary print	Additional printout of the individual items
COM1, COM2	Selecting the printer interface for the selected printout
Off	No automatic printout
Standard	Automatic printout using the standard template which is predefined in the factory.
Template 1 ... Template 10	Automatic printout using the selected template

6.4.7 Application → Memory

Memory	Selecting information to be stored with the alibi data record in the additional custom field
Custom field	Select from the following: Off, Terminal model, Terminal location, Article, Article description, ID1, ID2, ID3, APW, Quantity, Counting accuracy, SNo. Terminal, Temperature (for ICS4_5k-.../f only), Weight position

6.4.8 Application → Database

Database	Database settings
Description field	When set to On , each data record has an additional field to enter e.g., an article name
Delete record	Select a data record to be deleted.
Delete all	Delete all data records. A safety prompt is displayed.
Print all	Print all data records.

6.4.9 Application → Prompting

Prompting	Selecting workflows
Apps	Selecting the workflow which shall be supported by the prompt
Tare/Sample	Reference determination: First tare, then add reference parts
Sample/Tare	Reference determination: First weigh reference parts, then tare
Handsfree	Counting without a keystroke
Multi tare	Taring of several containers with the same tare weight
Additive tare	Adding the known tare weight of different containers
Take away	Over/Under Checkweighing out of a container without pressing a key

6.4.10 Application → Reset

Reset	Resetting the application settings to factory settings
Perform reset?	– Confirm resetting with <input type="checkbox"/> OK <input type="checkbox"/> .

6.5 Terminal menu block

6.5.1 Terminal menu overview

The `Terminal` menu block consists of the following main subblocks, which are described in detail in the following.

- Device
- Access
- Reset

Factory settings are printed in **bold** in the following overview.

6.5.2 Terminal → Device

Overview

Level 1	Level 2	Level 3	Level 4	Level 5
Region	Language	English , US-english, Deutsch, Français, Italiano, Español, Chinese, ...		
	Date format	MM/DD/YY, MM/DD/YYYY, MMM/DD/YYYY, DD/MM/YY, DD/MMM/YYYY, YY/MM/DD, YYYY/MMM/DD, YYYY/MM/DD, DD/MM/YYYY		
	Set date	Set year		
		Set month		
		Set day		
	Time format	24:MM, 12:MM tt, 24:MM:SS , 12:MM:SS tt		
Set time	Set hour			
	Set minutes			
Energy save	Backlight	On , 5 seconds, 10 seconds, 15 seconds, 30 seconds		
	Power off	Off , 1 minute, 3 minutes, 5 minutes, 15 minutes, 30 minutes		
Identification	Terminal location			
	Terminal ID			
Display	Display layout	Default , 3-lines mode, Color mode, Big font mode		
	Contrast	1 ... 5 ... 10		
	Brightness	1 ... 10		
	Weight hold	0 s ... 10 s		
	Default color	White , Yellow, Red, Green, Blue, Violet, Dark blue, Grey (not for ICS445)		
	Auxiliary line	Not used, Date & Time (for battery devices incl. remaining capacity in % and in hours), Gross, Net, Tare, High resolution (not available for approved scales), ID1, ID2, ID3, Bargraph, Temperature (for ICS4_5k-.../f only), Consecutive No., APW, Reference count, Quantity, Cnt.Accuracy, Target, Tolerance-, Tolerance+, Deviation, Article, Article descrip., Total gross, Total net, Total PCS, Lot		

Level 1	Level 2	Level 3	Level 4	Level 5	
Keyboard	Hard keys	Power, Clear, Switch, Info, Transfer, Numeric keys	On, Off		
	Soft key	Soff key 1-1 ... Soff key 4-4	Not used, Zero, Tare, High resolution, Avg. weighing, ID1, ID2, ID3, Prompt, Alibi memory, Switch scale, Ref N, APW, APW opt., Weight count, Totalizing, Over/Under, Save article, Recall article, Display layout, Consecutive No.		
	Info key	Page 1	Item 1 ... Item 5	Not used, Date & Time, Highres & Net, Gross, Net, Tare, ID1, ID2, ID3, Terminal ID, Terminal loc, Terminal model, SNo. Terminal, Terminal FW, SNo. Scale, Scale FW, Target, Tolerance-, Tolerance+, Deviation, APW, Quantity, Article, Article descrip., Total gross, Total net, Total PCS, Lot, Temperature (for ICS4_5k-.../f only), MinWeigh, IP address, Subnet mask, Gateway, USB version, Consecutive No.	
			Page 2 & 3	Info page 2	Off, System info, Contact info
				Info page 3	Off, System info, Contact info
		Beeper	On , Off		
Message time	1 s, 2 s , ... 6 s				
Battery	Charge strategy	Full , Preservation			
Timeout	Mode	Off, Rental, Rental info			
	Set date	Set year, Set month, Set day			



Description

Region	Country specific settings
Language	Selecting the language of the operator interface. We will expand the available languages continuously.
Date format	Selecting the date format.
Set date	Entering the date in the selected format.
Set month	Entering the month in the selected format.
Set day	Entering the day in the selected format.
Time format	Selecting the time format.
Set time	Entering the time in the selected format.
Set hour	Entering the hour in the selected format.
Set minutes	Entering the minutes.

Energy save (Operator access)	Setting the energy saving mode
Backlight	Settings for switching off the backlighting
On	Backlight always on
5 seconds ... 30 seconds	Selecting the time period after which the device switches off display and backlighting when not in use and gross weight is 0. Display and backlighting are switched on again by pressing a key or if the weight changes.
Power off	Settings for switching off the device
Off	No energy saving mode
1 minute ... 30 minutes	Selecting the time period after which the device switches off when not in use and gross weight is 0. After this, it must be switched on again using  .

Identification	Setting terminal identification data
Terminal location	Entering the terminal location, e.g., floor and room
Terminal ID	Entering the terminal identification, e.g., inventory number
Notes	<ul style="list-style-type: none"> Terminal location and terminal identification can be displayed in the auxiliary or info lines or printed out. Terminal location and terminal identification can consist of up to 12 characters (0 ... 9 and decimal point).

Display	Setting the display according to your specific task
Display Layout	Selecting the presentation of the weight value.
Contrast (Operator access)	Setting the contrast of the display. This menu item is accessible with Operator access rights.
Brightness (Operator access)	Setting the brightness of the display. This menu item is accessible with Operator access rights.
Weight hold	Setting how long (in seconds) the weighing result is frozen in the display after the transfer key  has been pressed or auto print was generated.
Default color	Setting the default color for straight weighing (not for ICS445).
Auxiliary line	Selecting the contents of the auxiliary display line.

Keyboard	Setting the keyboard according to your specific task
Hard keys	Locking/unlocking keys Possible keys: Power (), Clear (C), Switch / Toggle (), Info (i), Transfer (), Numeric keys (ICS465 and ICS469 only)
Soft keys	Assigning a function to the selected key
Soft key 1-1 ... Soft key 4-4	1 Select the soft key number. 2 Assign function.
Info key	Configuring the items to be displayed using the info key (i)
Page 1	On the first page of the info key up to 9 information items on the weighing process can be configured. 1 Select item number. 2 Assign information
Page 2, Page 3	On pages 2 and 3 system and contact information will be displayed. In case of a problem, here you will find your contact data and the system information the service technician will ask for. System information is set by the manufacturer, contact information can be entered directly.
Beeper	When set to On, each keystroke will be confirmed by a short beep.

Message time	Setting how long a message is displayed
1, 2, 3, 4, 5, 6	Setting how long a message is displayed in seconds

Battery	Battery settings
Charge strategy	Setting the charging strategy.
Full	The battery will always be fully charged.
Preservation	Charging to prevent total discharge.

Time out	Setting the behaviour when no action takes place on the terminal
Mode	Setting the time out mode.
Off	No time out setting.
Rental	The scale can only be used until a set date, e.g., when the scale is rented for a special event like a fair or a market. After the expiration date a message is displayed: Rental expired and the scale can no longer be used.
Rental info	When the set date has passed, a message is displayed: Rental expired . By pressing the key C , the message is cleared and the scale can be used as before.
Set date	Entering the expiration date.
Set year	Entering the year of the expiration date.
Set month	Entering the month of the expiration date.
Set day	Entering the day of the expiration date.

6.5.3 Terminal → Access

Supervisor	Password for Supervisor menu access
Password	Enter password for Supervisor menu access.
Retype password	Repeat the password entry.
Note	The password can consist of up to 4 characters.

6.5.4 Terminal → Reset

Reset	Resetting the terminal settings to factory settings
Perform reset?	– Confirm resetting with <input type="checkbox"/> <input checked="" type="checkbox"/> .

6.6 Communication menu block

6.6.1 General



For detailed information on interface protocols and commands refer to the SICS Reference manual.

The `Communication` menu block consists of the following subblocks:

- Overview Showing the installed interfaces.
- COM1 Parameter settings for the standard RS232 interface COM1.
- COM2 Parameter settings for the optional second interface COM2.
- Define templates Defining templates to be assigned to the application-specific printouts.

The interfaces identify themselves. Therefore only those menu settings appear which are relevant for the individual interface. If no optional interface is installed, the COM2 menu will not appear.

6.6.2 Overview of the communication menu blocks

Possible settings

		COM1	COM2					
		RS232	RS232	RS422 / RS485	Ethernet	WLAN	USB Device	USB Host
Mode	Print	X	X	X	X	X	X	–
	Auto print							
	Instant print							
	Continuous (Dialog)*							
	Dialog*	Factory setting						
	External input	X	X	X	X	X	X	X
	Toledo cont.-weight Toledo cont.-count SICS scale X scale Digitol B Digitol G	X	X	X	X	X	X	–
Second display	X	X	X	X	X	–	–	
SICSpro scale	–	–	X	–	–	–	–	
Printer	X	X	X	X	X	X	–	
External input	X	X	X	X	X	X	X	

		COM1		COM2				
		RS232	RS232	RS422 / RS485	Ethernet	WLAN	USB Device	USB Host
Parameter	Baud (factory setting)	9600	9600	9600	–	–	–	–
	Parity (factory setting)	8 none	8 none	8 none	–	–	–	–
	Handshake	X	X	X	–	–	–	–
	Checksum**	X	X	X	X	X	–	–
	STX**	X	X	X	X	X	–	–
	RS Type Net Address Load resistor	–	–	X	–	–	–	–
	DHCP IP address Subnet mask Gateway	–	–	–	X	X	–	–
TCP settings		–	–	–	X	X	–	–
Wireless settings		–	–	–	–	X	–	–

* for more information see SICS Reference manual

** only available for Toledo cont. modes

RS232 menu block

Level 1	Level 2	Level 3	Level 4
Mode	Print, Auto print, Instant print, Dialog , Continuous (Dialog), External input, Toledo Cont.-weight, Toledo Cont.-count, Second display, SICS scale, X scale		
	Digitol B, Digitol G	Net Gross Tare	On, Off
Printer	Type	ASCII printer , Values only	
	ASCII Format	Line format	Multiple , Single, Fixed
		Line length	1 ... 24 ... 100
		Separator (for line format Single only)	, ; – _ / \ Space
		Add line feed	0 ... 9
External input	Preamble length		
	Data length		
	Postamble length		
	Termination character	CR, LF, EOT, ...	
	Destination	Off, Tare preset, ID1, ID2, ID3, APW, Article, Target	
Parameter	Baud	300, 600, ... 9600 , ... 115200 baud	
	Parity	7 none, 8 none, 7 odd, 8 odd, 7 even, 8 even	
	Handshake	Off, Xon – Xoff	
	Checksum	Off, On	
Reset RS232	Perform Reset?		

RS422 / RS485 menu block

Level 1	Level 2	Level 3
Mode	Print, Auto print, Instant print, Dialog , Continuous (Dialog), External input, Toledo Cont.-weight, Toledo Cont.-count, Second display, SICS scale, X scale, SICSpro scale	
Printer	see RS232	
External input		
Parameter	Baud	300, 600, ... 9600, ... 115200 baud
	Parity	7 none, 8 none , 7 odd, 8 odd, 7 even, 8 even
	Handshake	Off , Xon – Xoff
	RS-Type	RS422 , RS485
	Net address	0 ... 31
	Checksum	Off , On
	Load resistor	Off , On
Reset RS4xx	Perform Reset ?	

Ethernet menu block

Level 1	Level 2	Level 3
Mode	see RS232	
Printer		
External input		
Parameter	DHCP	Off , On
	Local IP	
	Subnet mask	
	Gateway	
	Checksum	Off , On
TCP Mode	TCP Mode	Server , Client, FreeWeigh
	Local Port	4305
	Remote IP	
	Remote port	
	Connect timeout	
	Disconnect timeout	
Reset Ethernet	Perform Reset?	

WLAN menu block

Level 1	Level 2	Level 3
Mode	see RS232	
Printer		
External input		
Parameter	see Ethernet	
TCP mode	see Ethernet	
Wireless setting	SSID	
	Encryption	Off, WEP, WPA
	WEP settings	64 Bit, 128 Bit
	WEP key	Key 1, Key 2, Key 3, Key 4
	WPA settings	WPA-TKIP, WPA2-AES
	Password	
Status	Display the current status, e.g., connection status, signal strength	
Reset WLAN	Perform Reset?	

USB Host menu block

Level 1	Level 2	Level 3
USB version		
Keyboard / Barcode Reader	Preamble length	
	Data length	
	Postamble length	
	Termination char.	
	Destination	
USB settings	Alibi on the fly	On, Off



USB Device menu block

Level 1	Level 2	Level 3	Level 4
Mode	Continuous (Dialog), Dialog , External input, Toledo Cont.-weight, Toledo Cont.-count, Print, Auto print, Instant print		
	Digitol B, Digitol G	Net, Gross, Tare	On, Off
Printer	see RS232		
Parameter	Checksum	Off , On	
Reset USB	Perform Reset?		



The driver for USB Device is available on the CD delivered with the weighing terminal.

6.6.3 Description of the communication menu blocks

Mode	Operating mode of the serial interface
Print	Manual data output to the printer with 
Auto print	Automatic output of stable results to the printer (e.g., for series weighing operations)
Instant print	Manual data output of the current weight value (either stable or not) to the printer with 
Dialog	Bi-directional communication via MT-SICS commands, control of the device via PC
Continuous (Dialog)	Ongoing output of all weight values via the interface
External input	Input other than via terminal keypad. What the input is used for is defined in the <code>Destination</code> menu block.
Toledo Cont.-weight	TOLEDO Continuous mode
Toledo Cont.-count	TOLEDO Continuous mode with counting results
Second display	On the selected interface port, a second display is connected.
SICSpro scale	On the selected interface port, a SICSpro scale is connected.
SICS scale	On the selected interface port, a SICS scale is connected.
X scale	On the selected interface port, an X scale is connected.
Digitol B Digitol G	Digitol compatible format. The gross weight is identified by "B". Digitol compatible format. The gross weight is identified by "G".
Net, Gross, Tare	Selecting the weight values to be transferred.
Notes	Printing conditions for <code>Auto print</code> : <ul style="list-style-type: none"> • The weight must be heavier than 9 display increments. • A weight change of at least 9 display increments is required to initiate the next printout.

Printer	Configuring printer and formats for the protocol printout	
Type	ASCII printer	If <code>Values only</code> is selected, the transmitted data does not include the name of the variable, e.g., date, gross, ID1, but the value and, if appropriate, the unit, as a separate line. This allows the label printer to fill its template with the required data.
	Values only	
ASCII format	Line format	Selecting line format (for ASCII printers only)
	Multiple	Multiple lines
	Single	Single lines
	Fixed	Fixed (records output in single lines; every record includes the number of characters that was defined under <code>Line length</code>)
	Line length	Setting line length This item is only displayed for the line formats <code>Multiple</code> and <code>Fixed</code> .
	Separator	Selecting the separator This item is only displayed for the line format <code>Single</code> .
	Add line feed	Adding line feeds





External input	Configuring input via barcode reader
Preamble length	The barcode may contain additional data before the relevant data (preamble) and behind (postamble). – Enter the number of characters of preamble, (relevant) data and postamble.
Data length	
Postamble length	
Termination char.	Selecting the termination character which is used by the connected barcode scanner
Destination	Selecting the item to be entered via barcode scanner

USB Host	Configuring the USB Host interface
USB version	Show the implemented USB version
Keyboard / Barcode reader	Configure the external input via keyboard or barcode
Preamble length	The barcode may contain additional data before the relevant data (preamble) and behind (postamble). – Enter the number of characters of preamble, (relevant) data and postamble.
Data length	
Postamble length	
Termination char.	Selecting the termination character which is used by the connected barcode scanner
Destination	Selecting the item to be entered via barcode scanner
USB settings	Configuring an external alibi memory
Alibi on the fly	When set to <code>On</code> and a USB stick is inserted, the records are stored on the USB stick as well.

Connecting an USB keyboard

- To connect an external keyboard via USB Host, the COM port has to be defined as `External input` with the termination character LF.
- If a function is assigned to the external input as well, e.g., "Load article", use the Enter key to confirm the external input.

The function keys of the USB keyboard correspond to the following keys on the weighing terminal:

F1		F8	Displayed soft key 4
F2		F9	Displayed soft key 5 (right)
F3		ESC	 in the menu
F4		Back	Delete text character by character
F5	Displayed soft key 1 (left)	Enter	In straight weighing: print As external input: confirm
F6	Displayed soft key 2	Cursor keys	Cursor keys
F7	Displayed soft key 3		

Parameter	Communication parameters
Baud	Selecting baud rate
Parity	Selecting parity
Handshake	Selecting handshake
Checksum	Activating/deactivating checksum byte
STX	Activating/deactivating STX If STX is set to <code>On</code> , the STX signal (0x02) is sent at the beginning of each output string that is sent via the interface.
RS Type	Selecting type of the optional RS422/RS485 interface: either RS422 or RS485
Net Address	Assigning network address
Load resistor	To avoid reflections on a network, we recommend to make a defined termination. For this purpose, the load resistor within the terminal can be used. When set to <code>On</code> , a resistor of approx. 100 Ohm between the signal lines is enabled.
DHCP	If DHCP is set to <code>On</code> , the device will receive the IP address automatically. Then IP address, Subnet mask and Gateway are read-only fields.
Local IP	Displaying/entering the local IP address
Subnet mask	Displaying/entering subnet mask
Gateway	Displaying/entering gateway address
Note	Not all parameters are available on all serial interfaces. Refer to the overviews of the interfaces to check which parameters are available.

TCP Mode	Transmission control protocol settings
TCP Mode	Configuring TCP mode
Server	Weighing terminal acting as server E.g., to execute SICS commands from a PC. To do so, the weighing terminal must be configured as Server and the PC must be configured as Client.
Client	Weighing terminal acting as client E.g., to print to a PC or printer. To do so, the weighing terminal must be configured as Client and the PC must be configured as Server.
FreeWeigh	To connect as SICS scale to freeweigh.net
Local Port	Displaying/entering the local port
Remote IP	Displaying/entering the remote IP address
Remote Port	Displaying/entering the remote port
Connect timeout	Setting timeout for connecting
Disconnect timeout	Setting timeout for disconnecting

6.6.4 Digital I/Os menu block

Level 1	Level 2	Level 3
Input	Input pin 1 ... Input pin 4	Off, Zero, Tare, Transfer, Switch, Clear, Info, Target, Softkey 1-1 ... 4-5, Total +, Total -, Switch scale
Output	Ready, Stable, Tare, Zero, < Min weigh, >= Min weigh, Underload, Overload, <= Setpoint 1, > Setpoint 1, <= Setpoint 2, > Setpoint 2, Good range, < Tolerance-, > Tolerance+, Star	Off , Output pin 1 ... Output pin 4
Setpoints	Setpoint 1, Setpoint 2	
Output mode	Continuous, Stable	

Configuring inputs

- 1 Select an input pin.
- 2 Assign an input signal to the selected input pin.

Configuring outputs

- 1 Select an output signal.
- 2 Assign an output pin.

Configuring setpoints

- Enter values for the setpoints.

Setting output mode

- Continuous Digital outputs are updated continuously
- Stable Digital outputs are updated only when the weight is stable

6.6.5 Define templates menu block

Level 1	Level 2	Level 3
Template 1 ... Template 5	Line 1 ... Line 30	Not used, Header *, Date, Time, Gross, Net, Tare, High resolution, ID1, ID2, ID3, Terminal ID, Terminal location, SNR Terminal, SNR Scale, Star line, New line, Form feed, Target, Tolerance -, Tolerance +, Tol. type, Description field, Deviation, Weight position, Average PW, Reference count, Quantity, Article, Article description

* The content of these items has to be entered via SICS command.

Configuring templates

- 1 Select a template.
- 2 Select a line.
- 3 Assign an item.

 There are 5 more templates available (Template 6 ... Template 10). Please ask your **METTLER TOLEDO** service technician to configure these templates or create them by yourself using the Data+ software (www.mt.com/DataPlus), if desired.

6.7 Maintenance menu block

6.7.1 Overview

Level 1	Level 2	Level 3	Level 4
Scale test	Scale 1 Scale 2	Internal test	Perform test?
		External test	Perform test?
		Conf. ext. test	Test weight Weight name Tolerance
	Auto print	On, Off	
Keyboard test	Perform test?		
Display test	Perform test?		
Serial no.	Serial no. Scale		
	Serial no. Terminal terminal		
Print setup	Print menu settings		
Tool comm.	Port		
	Baudrate		
	Start		
Reset all	Perform reset?		

6.7.2 Description

Scale test	Testing the selected scale
Internal test	Testing scales with an internal test weight
Perform test?	<ul style="list-style-type: none"> – Press <input type="checkbox"/> OK to start the test. <ul style="list-style-type: none"> ➔ The deviation between test weight value and actually weighed value is displayed.
External test	Testing scales without an internal test weight
Perform test?	<ol style="list-style-type: none"> 1 Press <input type="checkbox"/> OK to start the test. <ul style="list-style-type: none"> ➔ Preload is displayed. 2 If applicable, load the preload, and press <input type="checkbox"/> OK. ➔ The test weight is blinking. 3 Load the requested test weight and press <input type="checkbox"/> OK. ➔ The deviation between test weight value and actually weighed value is displayed.
Conf. ext. test	Configuring the external test weight
Test weight	Setting the test weight value
Weight name	Entering the test weight name
Tolerance	Setting the test tolerance
Auto print	Automatic printout When set to On , a protocol is printed for each scale test.

Keyboard test	Testing the keyboard
Perform test?	<ol style="list-style-type: none"> 1 Press <input type="checkbox"/>OK<input type="checkbox"/> to start the keyboard test. 2 Press the keys in the displayed order. <ul style="list-style-type: none"> ➔ If the key works, the device switches to the next key. ➔ The keyboard test is terminated by pressing .

Display test	Testing the display
Perform test?	<ol style="list-style-type: none"> 1 Press <input type="checkbox"/>OK<input type="checkbox"/> to start the display test. <ul style="list-style-type: none"> ➔ A checkerboard pattern is displayed. 2 Press any key to invert the checkerboard pattern. 3 Press any key to show the colored display (ICS465 and ICS469 only). 4 Repeat pressing a key until Completed is displayed. 5 Press <input type="checkbox"/>OK<input type="checkbox"/> to leave the display test.
Note	The display is working properly when all fields are displayed without missing pixels.

Serial number	Displaying serial numbers
SNo. Scale	Displaying the serial number of the connected weighing platform
SNo. Terminal	Displaying the serial number of the weighing terminal

Print setup	Printout of a list of all menu settings
Print menu settings	– Press <input type="checkbox"/> OK <input type="checkbox"/> to start the printout.

Tool communication	Testing the communication
Port	Selecting the COM port to be tested
Baudrate	Setting the baudrate for testing
Start	Starting tool communication test

Reset all	Reset all settings to factory setting
Perform reset?	– Reset all settings to factory settings with <input type="checkbox"/> OK <input type="checkbox"/> .

7 Event and error messages

7.1 Error conditions

Error	Cause	Remedy
Display dark	• Backlighting set too dark	– Set backlighting brighter.
	• No power supply	– Check power supply.
	• Unit switched off	– Switch on unit.
	• Power supply cable not plugged in	– Plug in power supply cable.
	• Brief fault	– Switch device off and on again.
Weight display unstable	• Unstable installation location	– Adjust vibration adapter.
	• Draft	– Avoid draft.
	• Unstable weighing sample	– Dynamic weighing.
	• Contact between weighing pan and/or weighing sample and surrounding	– Remedy contact.
	• Power supply fault	– Check power supply
Incorrect weight display	• Incorrect zeroing	– Unload scale, set to zero and repeat weighing operation.
	• Incorrect tare value	– Clear tare.
	• Contact between weighing pan and/or weighing sample and surroundings	– Remedy contact.
	• Weighing platform tilted	– Level weighing platform.
[_ _ _ _]	• Load plate not on the scale	– Place load plate on the scale.
	• Weighing range not reached	– Set to zero.
[_ _ _ _]	• Weighing range exceeded	– Unload scale. – Reduce preload.
— — — —	• Result not yet stable	– If necessary, adjust vibration adapter.
Attention: Approval invalid alternating with metrological data	• Approval was tampered with	– Call METTLER TOLEDO service technician.

7.2 Errors and warnings

Error messages

Error messages contain the following information:

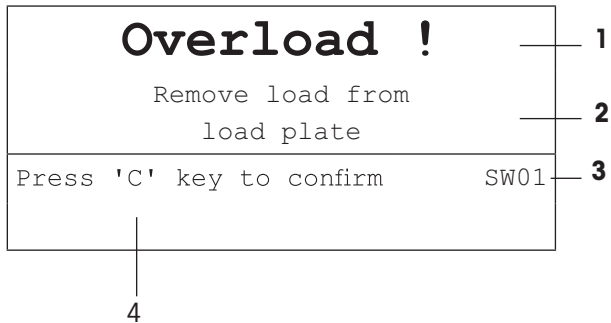

- 1 Error message
- 2 Remedy
- 3 Message identifier
- 4 How to clear the message

Warnings

Warnings are displayed briefly and then disappear automatically.

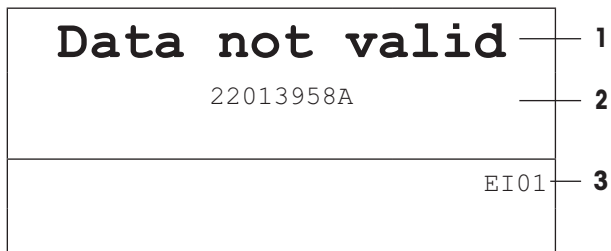

- 1 Warning
- 2 Additional information, e.g., which data is not valid
- 3 Warning identifier

7.3 Smart weighing counter / spanner icon

This weighing instrument features several control functions to monitor the condition of the device.

The **METTLER TOLEDO** service technician can setup and enable these functions.

This helps the user and the **METTLER TOLEDO** service technician to determine how the device is treated and what measures are needed to keep it in a good shape.

If the control functions triggers an alert, a message is shown.

You can confirm the message and continue to work with the weighing instrument. The spanner icon  lights up.

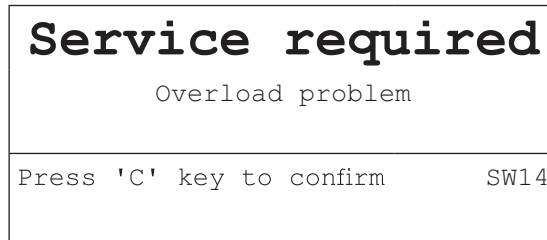

In case of an alert we strongly recommend calling the **METTLER TOLEDO** service technician

- to replace parts which are at the end of lifetime,
- to correct wrong settings,
- to educate operators about proper handling,
- to perform routine service work,
- to reset the alert.

The control functions monitor the following conditions:

- number of weighings
- number of overloads
- maximum weight
- zero commands and zero failures
- battery charging cycles
- power-on time
- date for the next service inspection

7.4 Service information



In case you need the **METTLER TOLEDO** service technician, you can read the necessary system and contact information from the device.

- 1 Press **i** twice.
 - ➔ System information data are displayed.
- 2 Press **i** again
 - ➔ Your contact data are displayed.

8 Technical data and accessories

8.1 Devices for dry environment

8.1.1 Technical data for weighing terminals for dry environments

ICS4_5 weighing terminals		
Housing	Aluminium diecast	
Display	LCD liquid crystal graphical display, with back lighting	
Keyboard	Tactile-touch membrane keypad (PET) Scratch-resistant labelling	
Protection type	With power supply connection	IP65
	With built-in storage battery	IP65
	With exchangeable battery	IP5x
	Weighing platform	IP5x / IP65 (option, not for 0.6XS)
Net weight	Weighing terminal	2.0 kg / 4.4 lb
Power supply connection	Direct connection to power supply (supply voltage fluctuation not exceeding ± 10 % of the rated voltage)	
	Rated voltage	100 ... 240 V AC / 50 ... 60 Hz / 300 mA
	Power cord	approx. 2.5 m / 8.2 ft
Battery operation	Supply of device	12 V  / 2.5 A
	Up to 22 hours of operation possible	
9-28 VDC power supply	Rated voltage	9 ... 28 V  / max. 2.5 A
	Power cord	approx. 5 m / 16 ft, open ends
Battery charger	Ambient conditions	0 ... 40 °C / 32 ... 104 °F, dry environment
Ambient conditions	Application	indoor use only
	Altitude	up to 2,000 m
	Temperature range Class III	-10 ... 40 °C / 14 ... 104 °F
	Temperature range Class II with PBK785 with PBK9-series / PFK9-series	10 ... 30 °C / 50 ... 86 °F 0 ... 40 °C / 32 ... 104 °F
	Overvoltage category	II
	Pollution degree	2
	Humidity	Max. rel. humidity 85 % for temperatures up to 40 °C / 104 °F
W & M approvals	OIML Class II, III, IIII NTEP Class II, III	

Interfaces	
Communication interfaces	1 RS232 interface integrated 1 additional optional communication interface possible
Scale interfaces	1 scale interface integrated 1 additional optional scale interface possible, either analog or IDNet IDNet scales except F cell, AWU cell, GD16, GD17, Pik

8.1.2 Technical data for compact scales for dry environments



- The size of the weighing platform (0.6XS, 3XS, 6XS, 3SM, 6SM, 15LA, 35LA) is indicated at the end of the product name, e.g., **ICS445s-3XS/f**.
- Other combinations of weighing range and readability can be adjusted by the **METTLER TOLEDO** service technician on site.
- The table below indicates the factory settings of weighing range and readability.

Weighing ranges and readability ICS4_5s-.../f compact scales

- Approved resolution 1 x 6,000 e (OIML, NTEP)
- Non-approved resolutions up to 60,000 d

ICS4_5s-.../f	3SM	6SM	15LA	35LA
Capacity	3 kg	6 kg	15 kg	35 kg
	6 lb	12 lb	30 lb	60 lb
Readability				
Standard resolution: 6,000 d	0.5 g	1 g	2 g	5 g
	0.001 lb	0.002 lb	0.005 lb	0.01 lb
Optional resolution: 30,000 d	0.1 g	0.2 g	0.5 g	1 g
	0.0002 lb	0.0005 lb	0.001 lb	0.002 lb
Optional resolution: 60,000 d	0.05 g	0.1 g	0.2 g	0.5 g
	0.0001 lb	0.0002 lb	0.0005 lb	0.001 lb
Approved resolution: 6,000 e	0.5 g	1 g	2 g	5 g
	0.001 lb	0.002 lb	0.005 lb	0.01 lb
Repeatability (sd)	0.05 g	0.1 g	0.2 g	0.5 g
	0.0001 lb	0.0002 lb	0.0005 lb	0.001 lb
Linearity	0.1 g	0.2 g	0.5 g	1 g
	0.0002 lb	0.0005 lb	0.001 lb	0.002 lb
Weight	5.5 kg	5.5 kg	7.7 kg	7.7 kg
	12.1 lb	12.1 lb	17.0 lb	17.0 lb

Weighing ranges and readability ICS4_5k-.../f and ICS4_5k-.../DR/f compact scales

- Approved resolution up to 61,000 e (OIML, NTEP)
- Non-approved resolutions up to 610,000 d
- FACT function (Fully Automatic Calibration Technology) calibrates the scale according to temperature changes thus increasing weighing accuracy

ICS4_5k-.../f	0.6XS	3XS	6XS	6SM	15LA	35LA
Capacity	0.61 kg	3.1 kg	6.1 kg	6.1 kg	15.1 kg	35.1 kg
	1.2 lb	6 lb	12 lb	12 lb	30 lb	60 lb
Readability						
Standard resolution	0.001 g	0.01 g	0.01 g	0.1 g	0.1 g	0.1 g
	0.000002 lb	0.00002 lb	0.00002 lb	0.0002 lb	0.0002 lb	0.0002 lb
Approved resolution	0.01 g	0.1 g	0.1 g	1 g	1 g	1 g
	0.00002 lb	0.0002 lb	0.0002 lb	0.002 lb	0.002 lb	0.002 lb
Repeatability (sd)	0.001 g	0.01 g	0.01 g	0.1 g	0.1 g	0.1 g
	0.000002 lb	0.00002 lb	0.00002 lb	0.0002 lb	0.0002 lb	0.0002 lb
Linearity	0.002 g	0.02 g	0.02 g	0.2 g	0.2 g	0.2 g
	0.000005 lb	0.00005 lb	0.0005 lb	0.0005 lb	0.0005 lb	0.0005 lb
Weight	6.3 kg	5.7 kg	5.7 kg	5.7 kg	9.0 kg	9.0 kg
	13.4 lb	12.6 lb	12.6 lb	12.6 lb	19.8 lb	19.8 lb

ICS4_5k-.../DR/f	0.6XS	3XS	6XS	6SM	15LA	35LA
Capacity	0.12 kg / 0.61 kg	0.6 kg / 3.1 kg	1.2 kg / 6.1 kg	1.2 kg / 6.1 kg	3 kg / 15.1 kg	3 kg / 15.1 kg
Readability						
Standard resolution	0.001 g / 0.01 g	0.01 g / 0.1 g	0.01 g / 0.1 g	0.1 g / 1g	0.1 g / 1g	0.1 g / 1g
Approved resolution	0.01 g	0.1 g	0.1 g	1 g	1 g	1 g

Max. mechanical preload without losing capacity

ICS4_5	3SM	6SM	15LA	35LA
Preload	1.25 kg	3.25 kg	3.32 kg	13.32 kg
	2.76 lb	7.17 lb	7.32 lb	29.37 lb

ICS4_5	0.6XS	3XS	6XS	6SM	15LA	35LA
Preload	–	1.73 kg	0.73 kg	2.25 kg	20.32 kg	0.32 kg
	–	3.81 lb	1.61 lb	4.96 lb	44.80 lb	0.71 lb

8.1.3 Operating life with battery

The operating life during battery operation varies depending on the intensity of use, the configuration and the connected scale.

The following approximate values apply with standard RS232 interface and the brightness set to 5.

Weighing platform	Weighing terminal type	Conditions	Duration
Strain gauge weighing platform	ICS4_5g	WLAN, continuous operation	16 h
		USB host, continuous operation	16 h
MonoBloc® weighing platform	ICS4_5k	WLAN, continuous operation	10 h
		USB host, continuous operation	10 h

8.1.4 Dimensional drawings for devices for dry environments

ICS4_5 weighing terminal

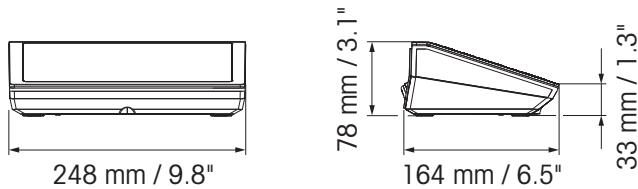

ICS4_5 compact scale with XS or SM weighing platform

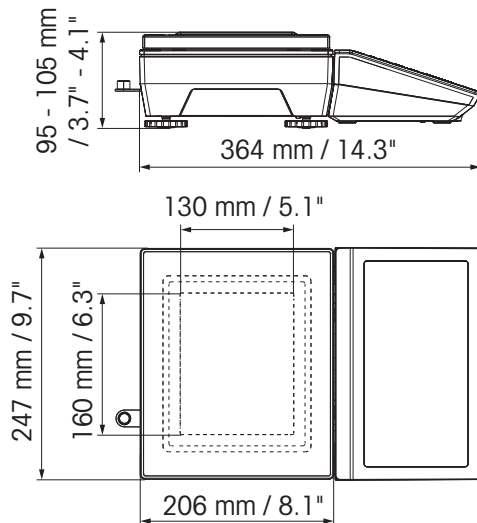

ICS4_5 compact scale with XS weighing platform and windshield

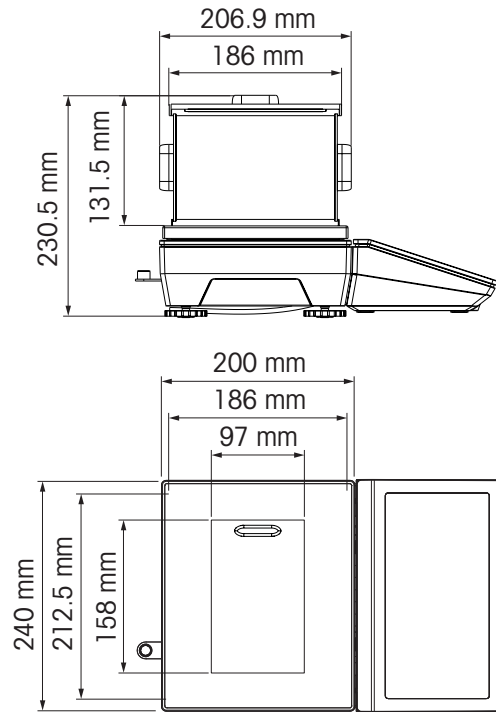

ICS4_5 compact scale with LA weighing platform

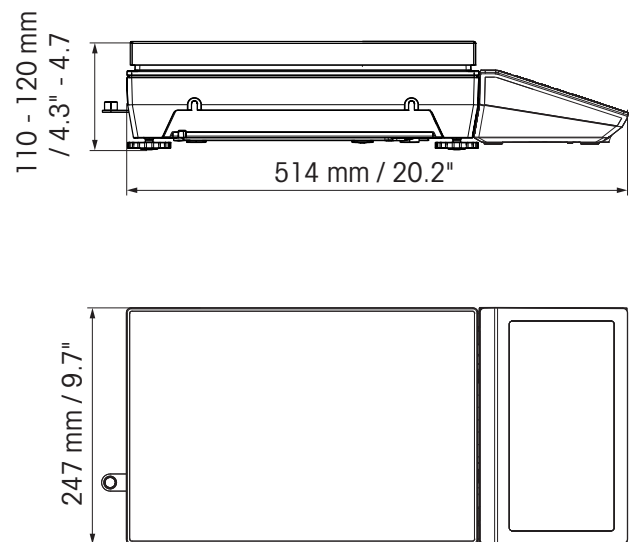
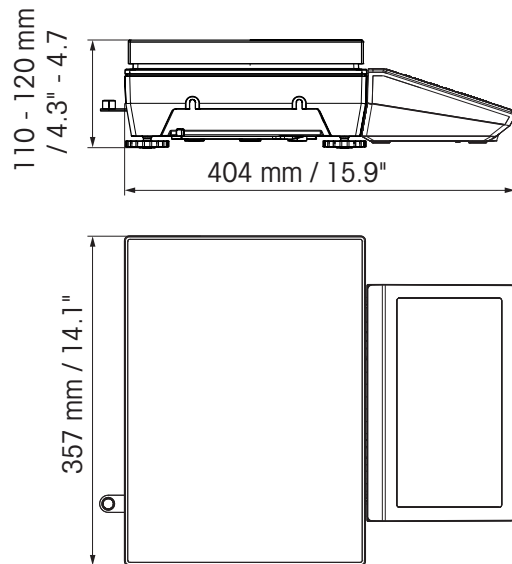

8.1.5 Accessories for dry environments



Accessories for ICS4_5	Order no.
Ticket Printer APR320	30 674 166
Printer APR510 Direct thermal Label Printer, 203 dpi	64 090 256
Printer APR510 Thermal Transfer Label Printer, 203 dpi	64 090 257
Printer APR510 Direct thermal Label Printer, 300 dpi	64 090 258
Printer APR510 Thermal Transfer Label Printer, 300 dpi	64 090 259
Printer APR710 Direct thermal Label Printer, 203 dpi	64 688 858
Printer APR710 Thermal Transfer Label Printer, 203 dpi	64 688 859
Printer APR710 Direct thermal Label Printer, 300 dpi	64 688 861
Protective cover for the weighing terminal, set of 5 pieces	30 032 638
Auxiliary display AD-RS-M7 (requiring cable 22 023 506)	12 122 381
Charging station for Battery pack (lithium ion)	30 093 236
Battery pack, lithium ion	
IP5x	30 093 237
IP65	30 093 238
Windshield for ...XS weighing platforms	72 262 929
Wall bracket	30 032 637
Support for wheeled bench stand	22 023 460
Column for PBA655, PBD655 and ICS4_5 / ICS685 compact scales (requires wall bracket 30 032 637)	
Height 330 mm / 1.3 ft	72 198 699
Height 660 mm / 2.6 ft	72 198 700
Floor stand, height 1000 mm / 3.3 ft	
Painted steel	22 023 451
Stainless steel	22 023 503
Relaybox 4, for Digital I/O	22 011 967
Power supply for Relaybox 4	00 505 544

Cables and plugs for ICS4_5	Order no.
Cables	
Cable M12 USB Female Type A, USB Host 0.2 m / 0.7 ft 3 m / 10 ft	22 017 604 22 017 608
Cable M12 USB Male Type A, USB device, 3 m / 10 ft	22 018 967
Cable M12 RS232 Female Sub D 9 pin (crossed; used for PC)	22 017 601
Cable M12 RS232 Male Sub D 9 pin (not crossed; used for SICS scale)	22 017 602
Cable M12 RS422/485, open ends	22 017 603
Cable M12 Digital I/O, open ends	22 018 969
Cable M12 Ethernet RJ45 5 m / 16 ft 20 m / 66 ft	22 017 610 22 017 614
Cable for auxiliary display AD-RS-M7	22 023 506
RS232 extension 0.5 m / 1.6 ft, incl. 5 V and 12 V	30 035 358
RS232 SICS (cross, M12 plug male / M12 male) 3 m	22 023 528
RS422/485 extension kit	22 023 698
SICSpro extension (M12 male / M12 female) * 3 m / 10 ft 10 m / 32 ft	22 023 696 30 024 759
SICSpro extension (M12 male / open end) 5 m / 16 ft *	30 024 768
Cable for GA46 0.4 m / 1.4 ft 2.5 m / 8 ft	22 018 978 22 018 979
Plugs	
RS232 Counter plug (8 pin; for compact scales, extension 30 035 358 required)	22 022 056
Ethernet Counter plug (4 pin, D; not for compact scales)	22 022 058
USB Device Counter plug (4 pin, A; not for compact scales)	22 022 059

* Maximum admissible extension length: 30 m / 100 ft

8.2 Devices for wet environment

8.2.1 Technical data for weighing terminals for wet environments

ICS4_9 weighing terminals		
Housing	Stainless steel 1.4301 or AISI 304	
Display	LCD liquid crystal graphical display, with back lighting	
Keyboard	Tactile-touch membrane keypad (PET) Scratch-resistant labelling	
Protection type	Terminal	IP68/IP69k
	Standard weighing platform with hermetically sealed stainless steel load cell	IP68/IP69k
	Weighing platform with option potted aluminum load cell	IP65
Net weight	Weighing terminal	2.0 kg / 4.4 lb
	ICS4_9g.../c	3.2 kg / 7.1 lb + weight of the weighing platform
Power supply connection	Direct connection to power supply (supply voltage fluctuation not exceeding $\pm 10\%$ of the rated voltage)	
	Rated voltage	100 ... 240 V AC 50 ... 60 Hz 300 mA
Battery operation	Supply of device	12 V  / 2.5 A
	Up to 22 hours of operation possible	
9-28 VDC power supply	Rated voltage	9 ... 28 V  / max. 2.5 A
	Power cord	approx. 5 m / 16 ft, open ends
Battery charger	Ambient conditions	0 ... 40 °C / 32 ... 104 °F dry environment
Ambient conditions	Application	indoor use only
	Altitude	up to 2,000 m
	Temperature range Class III	-10 ... 40 °C / 14 ... 104 °F
	Temperature range Class II	0 ... 40 °C / 32 ... 104 °F
	Overvoltage category	II
	Pollution degree	2
	Humidity	Max. rel. humidity 85 % for temperatures up to 40 °C / 104 °F
W & M approvals	OIML Class II, III, IIII NTEP Class II, III	
Interfaces		
Communication interfaces	1 RS232 interface integrated 1 additional optional communication interface possible	
Scale interfaces	1 scale interface integrated 1 additional optional scale interface possible, either analog or IDNet IDNet scales except F cell, AWU cell, GD16, GD17, Pik	

8.2.2 Technical data for terminal and platform combinations for wet environments

i ICS4_9 can be connected with different METTLER TOLEDO weighing platforms. For weighing range and readability of the weighing platforms, refer to the manual of the connected weighing platform.

8.2.3 Operating life with battery

The operating life during battery operation varies depending on the intensity of use, the configuration and the connected scale.

The following approximate values apply with standard RS232 interface and the brightness set to 5.

Weighing platform	Conditions	Duration
With 1 strain gauge load cell, e.g., ICS449g-A15...	Continuous operation	25 h
With 4 strain gauge load cells, e.g., a floor scale	Continuous operation	22 h
With PBK98_/PFK98_	Continuous operation	14 h

8.2.4 Dimensional drawings for devices for wet environments

ICS4_9 weighing terminal

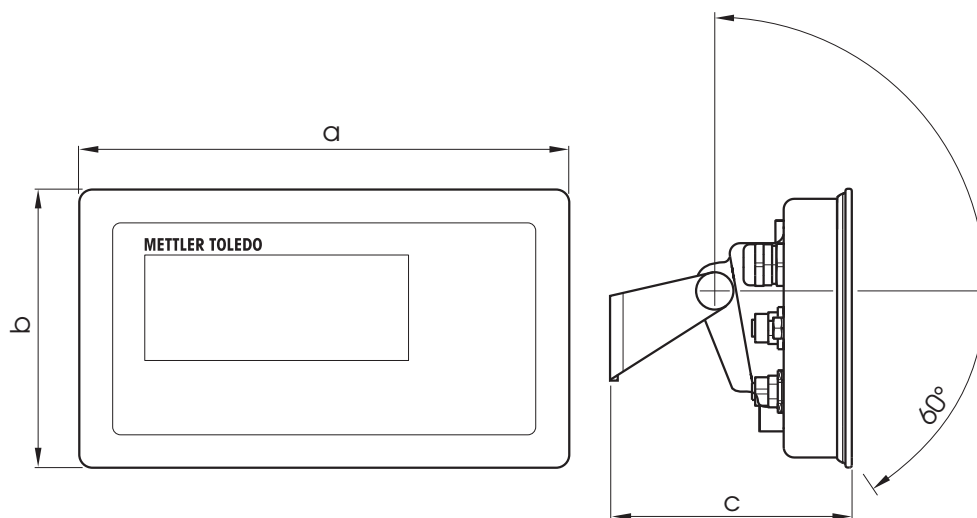

Dimension	[mm]	["]
a	232	9.13
b	132	5.20
c	115	4.53

Weighing platforms for ICS4_9g terminal and platform combinations

Front view

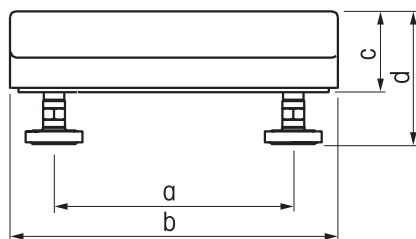

Side view

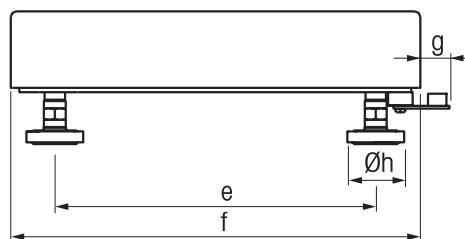

Dimensions		a	b	c	d*	e	f	g	h
PBA436-QA	mm	163	228	56	85.6	163	228	21	42
	inch	6.42	8.98	2.20	3.37	6.42	8.98	0.83	1.65
PBA436-A	mm	175	240	56	85.6	235	300	21	42
	inch	6.89	9.45	2.20	3.37	9.25	11.81	0.83	1.65
PBA436-QB	mm	240	305	57	96.6	253	305	18	42
	inch	9.45	12.01	2.24	3.80	9.96	12.01	0.71	1.65
PBA436-BB	mm	235	300	57	96.9	335	400	18	42
	inch	9.25	11.81	2.24	3.80	13.19	15.75	0.71	1.65
PBA436-B	mm	335	400	59	100.1	435	500	18	42
	inch	13.19	15.75	2.32	3.94	17.13	19.69	0.71	1.65
PBA436-BC	mm	437	500	73	110.8	584	650	17	42
	inch	17.20	19.69	2.87	4.36	22.99	25.59	0.67	1.65
PBA436-CC	mm	503	600	85	132.0	724	800	18	42
	inch	19.80	23.62	3.35	5.19	28.5	31.50	0.71	1.65
PBA439-QA	mm	163	228	56	85.6	163	228	21	42
	inch	6.42	8.98	2.20	3.37	6.42	8.98	0.83	1.65
PBA439-A	mm	175	240	56	85.6	235	300	21	42
	inch	6.89	9.45	2.20	3.37	9.25	11.81	0.83	1.65
PBA439-QB	mm	240	305	57	96.6	253	305	18	42
	inch	9.45	12.01	2.24	3.8	9.96	12.01	0.71	1.65
PBA439-BB	mm	235	300	57	96.6	335	400	18	42
	inch	9.25	11.81	2.24	3.8	13.19	15.75	0.71	1.65
PBA439-B	mm	335	400	59	100.1	435	500	18	42
	inch	13.19	15.75	2.32	3.94	17.13	19.69	0.71	1.65
PBA439-BC	mm	437	500	73	106.8	584	650	17	42
	inch	17.20	19.69	2.87	4.2	22.99	25.59	0.67	1.65
PBA439-CC	mm	503	600	85	128.3	724	800	18	42
	inch	19.80	23.62	3.35	5.05	28.5	31.50	0.71	1.65

* d = minimum platform height

- With the adjustable scale feet, the platform height can increase by 10 mm / 0.39 inch at maximum.
- With the hygienic kit option, the minimum platform height (d) is increased by 12 mm / 0.47 inch.

Dimensions		a	b	c	d*	e	f	g	h
PBA639-QA PBD659-QA	mm	178	228	70	110	178	228	21	40
	inch	7.01	8.98	2.76	4.33	7.01	8.98	0.83	1.57
PBA639-A PBD659-A	mm	190	240	70	110	250	300	21	40
	inch	7.48	9.45	2.76	4.33	9.84	11.81	0.83	1.57
PBA639-QB PBD659-QB	mm	255	305	70	110	255	305	21	40
	inch	10.04	12.01	2.76	4.33	10.04	12.01	0.83	1.57
PBA639-BB PBD659-BB	mm	250	300	70	110	350	400	21	40
	inch	9.84	11.81	2.76	4.33	13.78	15.75	0.83	1.57
PBA639-B PBD659-B	mm	350	400	83	126	450	500	21	40
	inch	13.78	15.75	3.27	4.96	17.72	19.69	0.83	1.57
PBA639-BC PBD659-BC	mm	450	500	90	134	600	650	21	40
	inch	17.72	19.69	3.54	5.28	23.62	25.59	0.83	1.57
PBA639-CC PBD659-CC	mm	550	600	90	134	750	800	21	40
	inch	21.65	23.62	3.54	5.28	29.53	31.50	0.83	1.57
PBA639-CC600 PBD659-CC600	mm	550	600	94	140.5	750	800	21	40
	inch	21.65	23.62	3.70	5.53	29.53	31.50	0.83	1.57

* d = minimum platform height

With the adjustable scale feet, the platform height can increase by 10 mm / 0.39 inch at maximum.

ICS4_9g-.../f terminal and platform combination

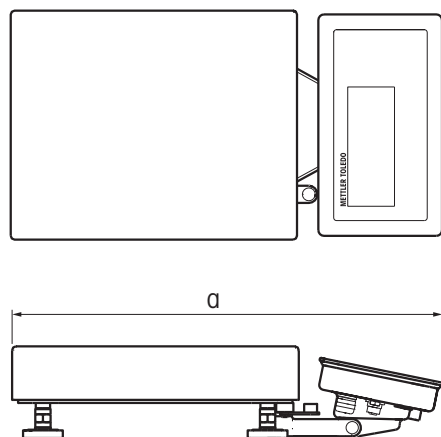

Compatible platforms	a		Compatible platforms	a – installed at short side		a – installed at long side	
	[mm]	[Inch]		[mm]	[Inch]	[mm]	[Inch]
PBA436-QA PBA439-QA	390	15.34	PBA639-QA PBD659-QA	380	14.97	–	–
PBA436-A PBA439-A	465	18.31	PBA639-A PBD659-A	445	17.52	380	14.97
PBA436-QB PBA439-QB	470	18.51	PBA639-QB PBD659-QB	457	18.00	–	–
PBA436-BB PBA439-BB	557	21.93	PBA639-BB PBD659-BB	575	22.64	455	17.92

ICS4_9g-.../c terminal and platform combination, with tower column

The size of the weighing platform (QA, A, QB, BB) is indicated at the end of the product name, e.g., **ICS449a-QA6**.

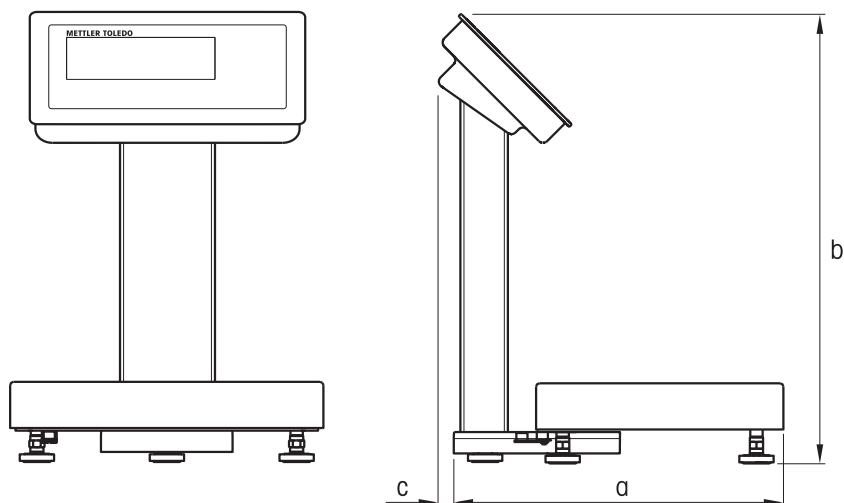

Compatible platforms	a		b		c	
	[mm]	[Inch]	[mm]	[Inch]	[mm]	[Inch]
PBA436-QA PBA439-QA	340	13.39	390	15.36	12	0.47
PBA436-A PBA439-A	405	15.95	390	15.36	12	0.47
PBA436-QB PBA439-QB	413	16.26	390	15.36	12	0.47
PBA436-BB PBA439-BB	502	19.77	390	15.36	12	0.47
PBA639-QA PBD659-QA	340	13.39	390	15.36	12	0.47
PBA639-A PBD659-A	348	13.71	390	15.36	12	0.47
PBA639-QB PBD659-QB	392	15.44	390	15.36	12	0.47
PBA639-BB PBD659-BB	384	15.12	390	15.36	12	0.47

ICS4_9g-.../c terminal and platform combination, with open column

The size of the weighing platform (QA, A, QB, BB, B, BC, CC) is indicated at the end of the product name, e.g., **ICS449a-QA6**.

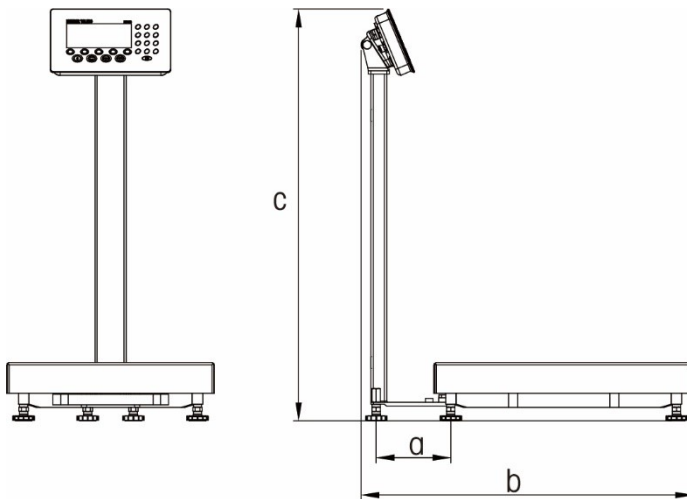

Compatible platforms	a		b		c	
	[mm]	[Inch]	[mm]	[Inch]	[mm]	[Inch]
PBA436-QA PBA439-QA	144	5.67	369	14.53	464	18.27
PBA436-A PBA439-A	144	5.67	440	17.32	464	18.27
PBA436-QB PBA439-QB	144	5.67	452	17.80	464	18.27
PBA436-BB PBA439-BB	144	5.67	540	21.26	464	18.27
PBA436-B PBA439-B	144	5.67	641	25.24	794	31.26
PBA436-BC PBA439-BC	144	5.67	791	31.14	1034	40.71
PBA436-CC PBA439-CC	144	5.67	935	36.81	1034	40.71

Compatible platforms	a		b – installed at long side		b – installed at short side		c	
	[mm]	[Inch]	[mm]	[Inch]	[mm]	[Inch]	[mm]	[Inch]
PBA636-QA PBD659-QA	147	5.79	369	14.53	–	–	450	17.72
PBA636-A PBD659-A	147	5.79	381	15.00	441	17.36	450	17.72
PBA636-QB PBD659-QB	147	5.79	446	17.56	–	–	450	17.72
PBA636-BB PBD659-BB	147	5.79	441	17.36	541	21.30	450	17.72
PBA636-B PBD659-B	147	5.79	541	21.30	641	25.24	780	30.71
PBA636-BC PBD659-BC	147	5.79	641	25.24	791	31.14	1020	40.16
PBA636-CC PBD659-CC	147	5.79	741	29.17	941	37.05	1020	40.16

ICS4_9g-.../c terminal and platform combination, with closed column

The size of the weighing platform (QA, A, QB, BB, B, BC, CC) is indicated at the end of the product name, e.g., **ICS449a-QA6**.

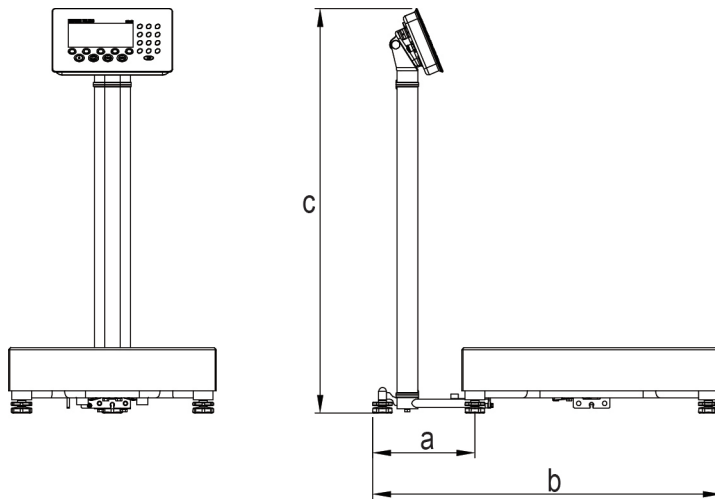

Compatible platforms	a		b – installed at long side		b – installed at short side		c	
	[mm]	[Inch]	[mm]	[Inch]	[mm]	[Inch]	[mm]	[Inch]
PBA636-QA PBD659-QA	197	7.76	399	15.71	–	–	450	17.72
PBA636-A PBD659-A	197	7.76	411	16.18	471	18.54	450	17.72
PBA636-QB PBD659-QB	197	7.76	476	18.74	–	–	450	17.72
PBA636-BB PBD659-BB	197	7.76	471	18.54	571	22.48	450	17.72
PBA636-B PBD659-B	197	7.76	571	22.48	671	26.42	780	30.71
PBA636-BC PBD659-BC	197	7.76	671	26.42	821	32.32	1020	40.16
PBA636-CC PBD659-CC	197	7.76	771	30.35	971	38.23	1020	40.16

8.2.5 Accessories for wet environments

Accessories for ICS4_9	Order no.
Label Printer APR331	30 452 312
I/O accessories	
Relaybox 4, for Digital I/O	22 011 967
Power supply for Relaybox 4	00 505 544
Mechanical parts	
Protective cover for terminals ICS4_9 , set of 3 pieces	22 021 109
Stand ICS4_9 for PBK, PFK, MA, MD and DB Platforms, height 330 mm / 1.1 ft	22 014 836
Open column ICS4_9 , for .../t version or terminal with PBA226, PBA426, PBA429, PBA436, PBA439	
Height 120 mm / 0.4 ft	72 219 393
Height 330 mm / 1.1 ft	72 198 702
Height 660 mm / 2.2 ft	72 198 703
Height 900 mm / 3.0 ft	72 198 704
Open column, for PBA639 or PBD659	
Height 330 mm / 1.1 ft	30 676 281
Height 660 mm / 2.2 ft	30 676 282
Height 900 mm / 3.0 ft	30 676 283
Closed column, for PBA639 or PBD659	
Height 330 mm / 1.1 ft	30 676 284
Height 660 mm / 2.2 ft	30 676 285
Height 900 mm / 3.0 ft	30 676 286
Bench stand ICS4_9 for scale bench 00 503 632 or 00 504 854, height 500 mm / 1.6 ft	22 014 835
Floor stand ICS4_9 , height 1000 mm / 3.3 ft	22 014 834
Standbase for floor stand	22 011 982
Wall bracket ICS4_9 , inclinable and swivelling	22 014 833
Front mount bracket for PBA436 or PBA439 for PBA639 or PBD659	22 021 062 30 676 290
Desk mounting plate, for terminal and .../t version only	22 021 111

Cables and plugs for ICS4_9	Order no.
Cables	
RS232 cable for SICS scale, 8 pin M12 <-> 9 pin sub D plug, 3 m / 10 ft	22 021 087
RS232 cable for PC, 8 pin M12 <-> 9 pin sub D receptacle, 3 m / 10 ft	22 021 088
RS422/RS485 cable, 6 pin M12 <-> open ends, 3 m / 10 ft	22 021 089
RS232 SICS (cross, M12 plug male / M12 male) 3 m	22 023 528
Ethernet cable, 4 pin M12 coding D <-> RJ45 5 m / 16.4 ft	22 021 090
20 m / 65.6 ft	22 021 091
Cable to connect Digital I/O option with relay box, 12 pin M12 <-> open ends, 10 m / 32.8 ft	22 021 093
USB Device cable, connection to PC, 3 m / 10 ft	22 021 092
USB Host cable, connection to scanner, keyboard or USB stick, M12 USB female type A 0.2 m / 0.7 ft	30 093 252
3 m / 10 ft	30 093 253
Plugs	
RS232 counter plug, 8 pin M12 (for .../f versions extension 30 035 358 required)	22 022 056
Ethernet counter plug, 4 pin, coding D, M12 (not for .../f versions)	22 022 058
USB Device counter plug, 4 pin, coding A, M12 (not for .../f versions)	22 022 059
RS422/485 extension kit	22 023 698

8.3 General technical data

8.3.1 Applications

- Weighing
- Over/Under Checkweighing
- Piece counting
- Average weighing
- Prompting
- Totalizing
- Internal database with up to 100 records
- Alibi log file

8.3.2 Analog scale interface

Impedance	≥ 87.5 Ohm, e.g., 1 x 350 Ohm or 4 x 350 Ohm
Excitation	3.3 V DC
Sensitivity	2 to 3 mV/V
Max. resolution	7,500 e (OIML) 300,000 d (non approvable)
Min. verification interval	0.264 µV/e

8.3.3 Assignment of the interface connections

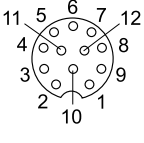
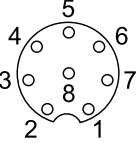
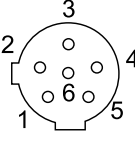
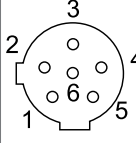
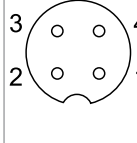
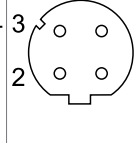
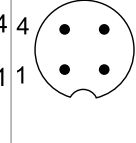
	Digital I/O	RS232	RS422	RS485	USB Device USB Host	Ethernet	Power
Socket							
Pin 1	In 0	CTS	TxD	T/RxD	+5 V *	TD+	+12 V *
Pin 2	In 1	TxD	TxD-	T/RxD-	D-	RD+	+12 V *
Pin 3	In 2	RTS	RxD	-	GND	TD-	GND
Pin 4	In 3	RxD	+12 V *	+12 V *	D+	RD-	GND
Pin 5	In_GND	+12 V *	GND	GND			
Pin 6	Out 0	+5 V *	RxD-	-			
Pin 7	Out 1	-					
Pin 8	Out 2	GND					
Pin 9	Out 3						
Pin 10	Out_GND						
Pin 11	+12 V *						
Pin 12	GND						

* max. 0.5 A

9 Appendix

9.1 Metrological information

Important notice for verified weighing instruments in EC-countries



Weighing Instruments, for which conformity is declared (legal verification), bear the preceding mark on the packing label and the metrology marking  on the descriptive plate. They may be put into use immediately.



Weighing Instruments on which declaration of conformity is carried out in two steps have no metrology marking on the descriptive plate and bear the preceding identification mark on the packing label. The second step has to be carried out by the authorized METTLER TOLEDO service engineer. Please contact your METTLER TOLEDO service organization.

The first step of the declaration of conformity has been carried out at the manufacturing plant. It comprises of all tests according to EN 45501-8.3.3. If national regulations in individual countries limit the period of validity of the verification, then the users of such a weighing instrument are themselves responsible for its timely re-verification.

9.2 Table of Geo code values

The Geo code feature provided in the weighing terminal permits adjustment by a METTLER TOLEDO service technician due to changes in elevation or latitude without reapplying test weights. This assumes that a previously accurate adjustment was done with the Geo code set properly for that original location and that the Geo code for the new location can be accurately determined.

When a weighing terminal is to be reinstalled at a different geographic location, gravitational and altitude changes can be accounted for by the following steps.

Note that this procedure is not necessary if an on-site adjustment is performed.

Determining the Geo code value

There are two methods to determine the Geo code value for your location.

Method A

- 1 Go to <https://www.welmec.org/welmec/gravity-information/> and obtain the g value (e.g. 9.770390 m/s²) for your specific geographic location.
- 2 Check the METTLER TOLEDO Geo code Table A to select the Geo code according to your g value, e.g. Geo code 20 should be applied if your g value is 9.810304.

Method B

- Use the METTLER TOLEDO Geo code Table B to determine the Geo code for the new altitude and location where the scale will be used.
The latitude and height above sea level can be found using this link <https://www.mapcoordinates.net/en>.

Checking the Geo code value in the instrument

- Switch the weighing terminal off and on again.
 - ➔ The currently set Geo code value is displayed when starting up.

Comparing Geo codes

- 1 Compare the determined Geo code with the current Geo code setting of the weighing terminal.
- 2 If the two Geo code values do not match, call the METTLER TOLEDO service technician.
When the system is certified, a re-verification will be necessary.

Note

Using the Geo code value for calibration adjustment is not as accurate as re-applying certified test weights and re-calibrating the scale in a new location.

Table A: Definition of METTLER TOLEDO Geo codes with g value

Geo code	g value (m/s ²)	Geo code	g value (m/s ²)	Geo code	g value (m/s ²)	Geo code	g value (m/s ²)
0	9.770390	8	9.786316	16	9.802295	24	9.818326
1	9.772378	9	9.788311	17	9.804296	25	9.820333
2	9.774367	10	9.790306	18	9.806298	26	9.822341
3	9.776356	11	9.792302	19	9.808300	27	9.824351
4	9.778347	12	9.794299	20	9.810304	28	9.826361
5	9.780338	13	9.796297	21	9.812308	29	9.828371
6	0.782330	14	9.798295	22	9.814313	30	9.830383
7	9.784323	15	9.800295	23	9.816319	31	9.832396

Table B: Definition of METTLER TOLEDO Geo codes with geographic latitude and height

Geographical latitude, North or South	Height above sea level											
	[m]	0 - 325	325 - 650	650 - 975	975 - 1300	1300 - 1625	1625 - 1950	1950 - 2275	2275 - 2600	2600 - 2925	2925 - 3250	3250 - 3575
	[ft]	0 - 1060	1060 - 2130	2130 - 3200	3200 - 4260	4260 - 5330	5330 - 6400	6400 - 7460	7460 - 8530	8530 - 9600	9600 - 10660	10660 - 11730
0° 0' - 5° 46' (0.0° - 5.77°)		5	4	4	3	3	2	2	1	1	0	0
5° 46' - 9° 52' (5.77° - 12.87°)		5	5	4	4	3	3	2	2	1	1	0
9° 52' - 12° 44' (12.87° - 12.73°)		6	5	5	4	4	3	3	2	2	1	1
12° 44' - 15° 6' (12.73° - 15.1°)		6	6	5	5	4	4	3	3	2	2	1
15° 6' - 17° 10' (15.1° - 17.17°)		7	6	6	5	5	4	4	3	3	2	2
17° 10' - 19° 2' (17.17° - 19.03°)		7	7	6	6	5	5	4	4	3	3	2
19° 2' - 20° 45' (19.03° - 20.75°)		8	7	7	6	6	5	5	4	4	3	3
20° 45' - 22° 22' (20.75° - 22.37°)		8	8	7	7	6	6	5	5	4	4	3
22° 22' - 23° 54' (22.37° - 23.9°)		9	8	8	7	7	6	6	5	5	4	4
23° 54' - 25° 21' (23.9° - 25.35°)		9	9	8	8	7	7	6	6	5	5	4
25° 21' - 26° 45' (23.35° - 26.75°)		10	9	9	8	8	7	7	6	6	5	5
26° 45' - 28° 6' (26.75° - 28.1°)		10	10	9	9	8	8	7	7	6	6	5
28° 6' - 29° 25' (28.1° - 29.42°)		11	10	10	9	9	8	8	7	7	6	6
29° 25' - 30° 41' (29.42° - 30.68°)		11	11	10	10	9	9	8	8	7	7	6
30° 41' - 31° 56' (30.68° - 31.93°)		12	11	11	10	10	9	9	8	8	7	7
31° 56' - 33° 9' (31.93° - 33.15°)		12	12	11	11	10	10	9	9	8	8	7
33° 9' - 34° 21' (33.15° - 34.35°)		13	12	12	11	11	10	10	9	9	8	8
34° 21' - 35° 31' (34.35° - 35.52°)		13	13	12	12	11	11	10	10	9	9	8
35° 31' - 36° 41' (35.52° - 36.68°)		14	13	13	12	12	11	11	10	10	9	9
36° 41' - 37° 50' (36.68° - 37.83°)		14	14	13	13	12	12	11	11	10	10	9

Geographical latitude, North or South	Height above sea level											
	[m]	0 - 325	325 - 650	650 - 975	975 - 1300	1300 - 1625	1625 - 1950	1950 - 2275	2275 - 2600	2600 - 2925	2925 - 3250	3250 - 3575
	[ft]	0 - 1060	1060 - 2130	2130 - 3200	3200 - 4260	4260 - 5330	5330 - 6400	6400 - 7460	7460 - 8530	8530 - 9600	9600 - 10660	10660 - 11730
37° 50' - 38° 58' (37.83° - 38.97°)		15	14	14	13	13	12	12	11	11	10	10
38° 58' - 40° 5' (38.97° - 40.08°)		15	15	14	14	13	13	12	12	11	11	10
40° 5' - 41° 12' (40.08° - 41.2°)		16	15	15	14	14	13	13	12	12	11	11
41° 12' - 42° 19' (41.2° - 42.32°)		16	16	15	15	14	14	13	13	12	12	11
42° 19' - 43° 26' (42.32° - 43.43°)		17	16	16	15	15	14	14	13	13	12	12
43° 26' - 44° 32' (43.43° - 44.53°)		17	17	16	16	15	15	14	14	13	13	12
44° 32' - 45° 38' (44.53° - 45.63°)		18	17	17	16	16	15	15	14	14	13	13
45° 38' - 46° 45' (45.63° - 46.75°)		18	18	17	17	16	16	15	15	14	14	13
46° 45' - 47° 51' (46.75° - 47.85°)		19	18	18	17	17	16	16	15	15	14	14
47° 51' - 48° 58' (47.85° - 48.97°)		19	19	18	18	17	17	16	16	15	15	14
48° 58' - 50° 6' (48.97° - 50.1°)		20	19	19	18	18	17	17	16	16	15	15
50° 6' - 51° 13' (50.1° - 51.22°)		20	20	19	19	18	18	17	17	16	16	15
51° 13' - 52° 22' (51.22° - 52.37°)		21	20	20	19	19	18	18	17	17	16	16
52° 22' - 53° 31' (52.37° - 53.52°)		21	21	20	20	19	19	18	18	17	17	16
53° 31' - 54° 41' (53.52° - 54.68°)		22	21	21	20	20	19	19	18	18	17	17
54° 41' - 55° 52' (54.68° - 55.87°)		22	22	21	21	20	20	19	19	18	18	17
55° 52' - 57° 4' (55.87° - 57.07°)		23	22	22	21	21	20	20	19	19	18	18
57° 4' - 56° 17' (57.07° - 56.28°)		23	23	22	22	21	21	20	20	19	19	18
56° 17' - 59° 32' (56.28° - 59.53°)		24	23	23	22	22	21	21	20	20	19	19
59° 32' - 60° 49' (59.53° - 60.82°)		24	24	23	23	22	22	21	21	20	20	19
60° 49' - 62° 9' (60.82° - 62.15°)		25	24	24	23	23	22	22	21	21	20	20
62° 9' - 63° 30' (62.15° - 63.5°)		25	25	24	24	23	23	22	22	21	21	20
63° 30' - 64° 55' (63.5° - 64.92°)		26	25	25	24	24	23	23	22	22	21	21
64° 55' - 66° 24' (64.92° - 66.4°)		26	26	25	25	24	24	23	23	22	22	21
66° 24' - 67° 57' (66.4° - 67.95°)		27	26	26	25	25	24	24	23	23	22	22
67° 57' - 69° 35' (67.95° - 69.58°)		27	27	26	26	25	25	24	24	23	23	22
69° 35' - 71° 21' (69.58° - 71.35°)		28	27	27	26	26	25	25	24	24	23	23
71° 21' - 73° 16' (71.35° - 73.27°)		28	28	27	27	26	26	25	25	24	24	23

Geographical latitude, North or South	Height above sea level											
	[m]	0 - 325	325 - 650	650 - 975	975 - 1300	1300 - 1625	1625 - 1950	1950 - 2275	2275 - 2600	2600 - 2925	2925 - 3250	3250 - 3575
	[ft]	0 - 1060	1060 - 2130	2130 - 3200	3200 - 4260	4260 - 5330	5330 - 6400	6400 - 7460	7460 - 8530	8530 - 9600	9600 - 10660	10660 - 11730
73° 16' - 75° 24' (73.27° - 75.4°)		29	28	28	27	27	26	26	25	25	24	24
75° 24' - 77° 52' (75.4° - 77.87°)		29	29	28	28	27	27	26	26	25	25	24
77° 52' - 80° 56' (77.87° - 80.93°)		30	29	29	28	28	27	27	26	26	25	25
80° 56' - 85° 45' (80.93° - 85.75°)		30	30	29	29	28	28	27	27	26	26	25
85° 45' - 90° 0' (85.75° - 90.0°)		31	30	30	29	29	28	28	27	27	26	26

9.3 Disposal

In accordance with the requirements of European Directive 2012/19/EU on Waste Electrical and Electronic Equipment (WEEE), this device may not be disposed of with domestic refuse. This also applies for countries outside the EU in accordance with their respective national regulations.

- Please dispose of this product in accordance with local regulations for the separate collection of waste electrical and electronic equipment.



Should you have any questions, please contact the corresponding authorities or the dealer from whom this device was purchased.

If this device is passed on (for example for further private or commercial/industrial use), this regulation is also to be passed on.

Many thanks for your contribution to the protection of the environment.

Battery disposal

Batteries contain heavy metals and therefore must not be disposed of in the normal refuse.

- Observe local regulations on the disposal of materials that are hazardous to the environment.

9.4 Protocol printouts

Examples of what can be adjusted (APR331 printouts, in English)

Printout with header and identification data

```
METTLER TOLEDO
Tel. +49 7431 140
Germany
www.mt.com
Date          27/04/2015
Time          21:50:48
ID1           Company ABC
ID2           67195 Town
Net           0.57 kg
Tare          0.82 kg
Gross         1.39 kg
```

Over/Under Checkweighing default printout

```
Position      <Tolerance
METTLER TOLEDO
Tel. +49 7431 140
Germany
www.mt.com
Date          08/01/2015
Time          00:02:53
ID1           Company ABC
ID2           67195 Town
Gross         2.090 kg
Target        90 PCS
Tol -         1 PCS
Tol +         1 PCS
Tol.Type      Relative
Dev.          -3 PCS
```

Piece counting

```
Date          08/01/2015
Time          00:06:31
Net           0.700 kg
Quantity      29 PCS
APW           23.96766 g
```

Over/Under Checkweighing minimum printout

```
Position      >Tolerance
Net           0.925 kg
```

Index

A

Accessories	
for dry environment	93
for wet environment	103
Alibi memory	
Calling up log file	32
Settings	69
Application	
Clever print	62
Average weighing	
Operation	23
Settings	62

C

Calibration	55
Cleaning	
in dry environment	33
in wet environment	33
Clever print	22, 62
Connections	
Power supply	14
Weighing platform	14
Counting	
APW optimization	64
Auto clear APW	64
Autosampling	64
Bulk scale	64
Counting system	64
Fixed reference size	63
Minimum reference weight	63
Procedure	35
Reference scale	64
Reference size	63
Total count	64

D

Database	
Recalling article	40, 46
Recalling pure tare article	20
Settings	69
Storing article	40, 46
Storing tare weight	20
Digital I/Os	82
Dimensional drawings	
Devices for dry environment	91

Devices for wet environment	96
Display	
3-line mode	6
Metrological data line	7
Serial numbers	84
Settings	72
Symbols and info line	8
Units	56, 60
Update	61
Weight value	8
Dynamic weighing	
Operation	23
Settings	62

E

Energy save	72
Error conditions	85
Error messages	86
External input	
Entry	24
Settings	80

F

FACT	
Settings	57
Symbol	8
Filter	57, 61

G

Geo Code	
Display	17
Geo code values	106

H

High resolution	25
Hygienically sensitive areas	16

I

Identifications	
Scale data	55, 59
Terminal data	72
Weighing data	24
Info key	
Displaying information	21
Settings	73
Interfaces	
Pin assignment	105

K		Hands free	28
<hr/>		Multi tare	29
Keyboard		Sample/Tare	27
Function keys	9	Settings	69
Settings	73	Take away	31
Soft keys	10	Tare/Sample	26
L		Protocol printouts	110
<hr/>		R	
Levelling	13	Reset	
Linearization	55	Application	69
Location	13	Reset all	84
M		Scale	58, 61
<hr/>		Terminal	74
Maintenance	83	Resolution	56
Menu		Restart	56, 60
Analog scale	54	S	
Application	62	<hr/>	
Communication	75	Safety instructions	4
Display	51	Service information	87
IDNet Scale	59	Smart weighing counter	87
Maintenance	83	Spanner icon	6, 87
Operation	50	Storage battery	15
Operator menu	50	Straight weighing	17, 62
Scale	53	Supervisor menu access	74
Supervisor menu	50	Switching on/off	17
Metrological data line	7	Switching scales	25
MinWeigh		Switching units	17
Settings	57, 61	T	
Symbol	8	<hr/>	
O		Taring	
<hr/>		Automatic	18
Over/Under Checkcounting		Automatic clearing the tare	18
Target values	43	Chain tare	19
Over/Under Checkweighing		Clearing the tare	18
Display	67	Manual	18
Output	66	Settings	56, 60
Procedure	44	Tare preset	19
Quick start	45	Technical data	
Subtractive weighing	44	Compact scales	89
Target values	43	Terminal and platform combinations	96
To zero	45	Weighing terminals for dry environment	88
Tolerance type	42, 65	Weighing terminals for wet environment	95
P		Templates	
<hr/>		Assigning	62
Printing	22	Defining	82
Clever print	22	Testing	
Printout configuration	62	Communication	84
Prompt			
Additive tare	30		

Display	84
Keyboard	84
Scale	83
Totalization	48, 68

V

Verification test	34
-------------------	----

W

Warning	86
---------	----

Z

Zeroing	
Automatic	18
Manual	18
Settings	56, 60

To protect your product's future:
METTLER TOLEDO Service assures
the quality, measuring accuracy and
preservation of value of this product
for years to come.

Please request full details about our
attractive terms of service.

www.mt.com

For more information

Mettler-Toledo (Albstadt) GmbH

Unter dem Malesfelsen 34
D-72458 Albstadt, Germany
Tel. +49 7431-14 0
Fax +49 7431-14 232
www.mt.com

Subject to technical changes.
© Mettler-Toledo (Albstadt) GmbH 03/2022
30243682F en



30243682