

Operating instructions

METTLER TOLEDO

B balance line

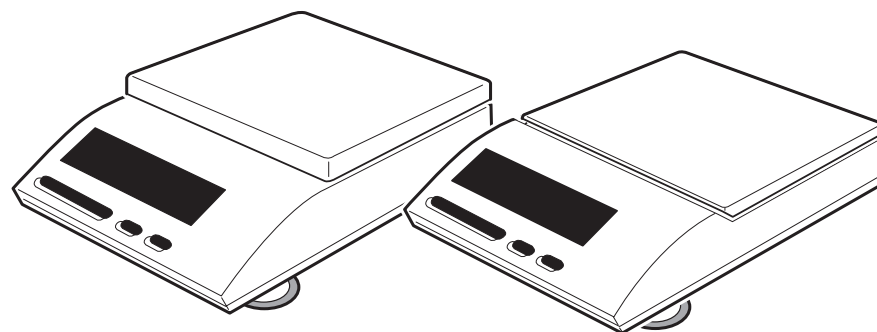
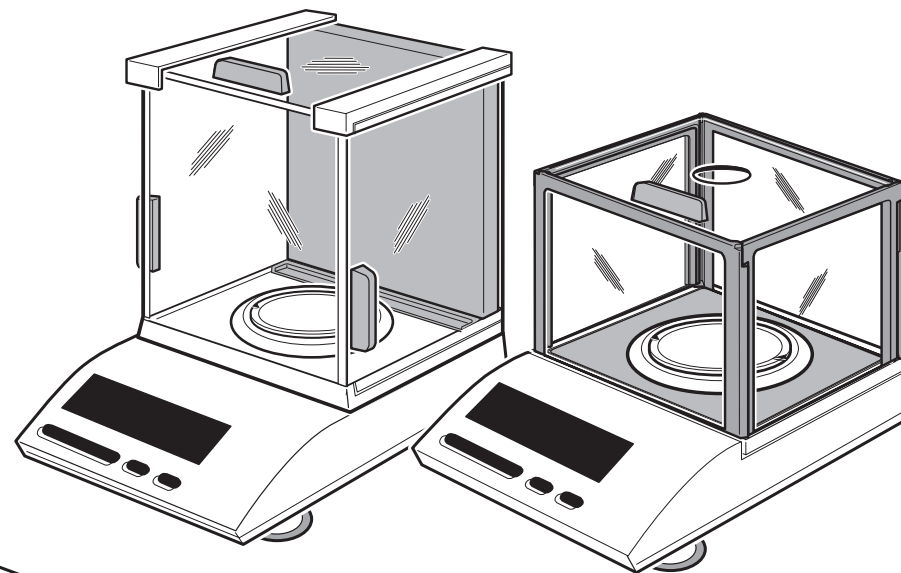

- AB
- PB
- SB

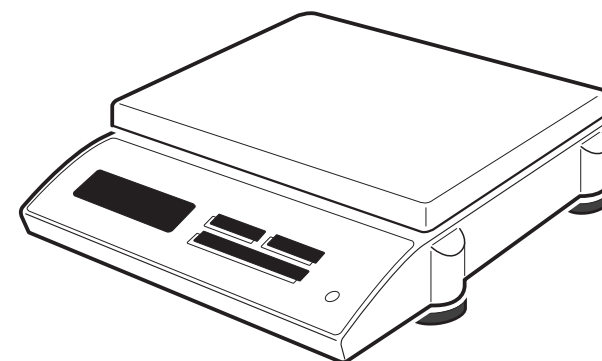

METTLER TOLEDO



Short-form operating instructions

-  Press key **briefly**
-  Press and **hold** key until the desired display appears
-  Automatic procedure

Switching on

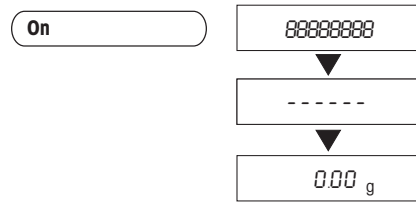

Switching off

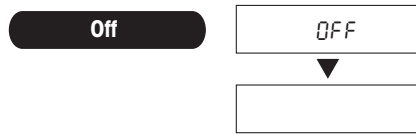

Simple weighing

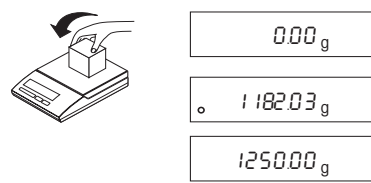

Adjusting (calibration)

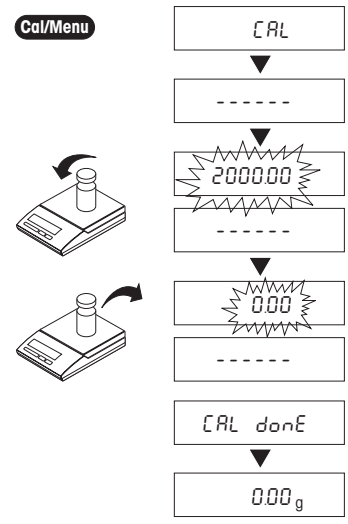

Taring

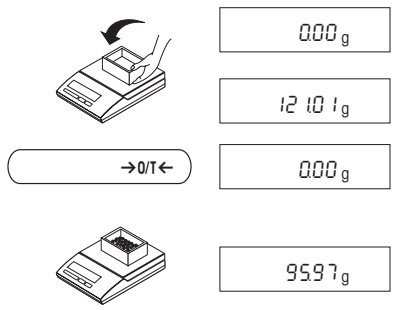

Piece counting*

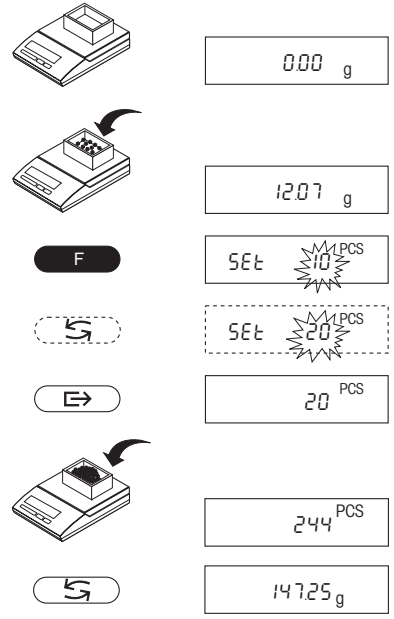

Percent weighing*

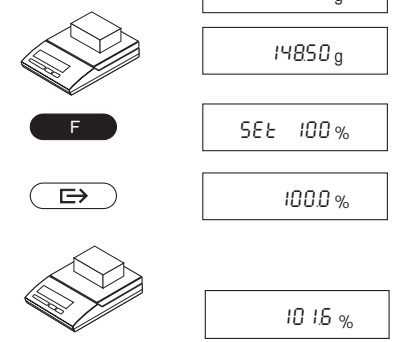

Dynamic weighing*

Automatic start (Dyn A)

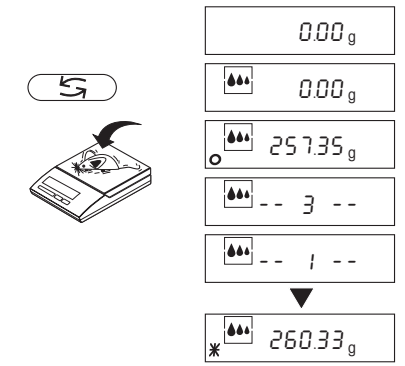

Manual start (Dyn M)

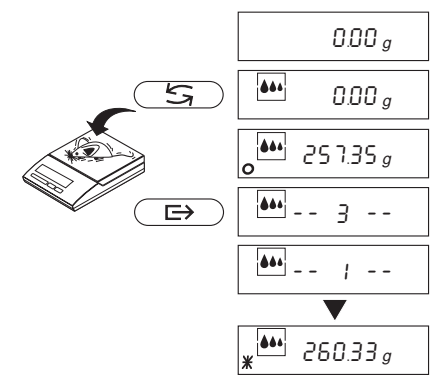

Unit switching*

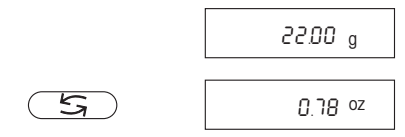

* These functions must be activated in the menu (section 4.1).

Contents

1	Getting to know the B balance line	2	5	Functions	16
1.1	Introducing the B balance line	2	5.1	Piece counting	16
1.2	Layout of the B balances	3	5.2	Percent weighing	17
1.3	The keys of the B balances (overview)	4	5.3	Dynamic weighing	18
2	Startup	5	5.4	Switching weight units	19
2.1	Unpacking / standard equipment	5	6	Technical data and optional equipment	20
2.2	Cautionary notes	5	6.1	Technical data	20
2.3	Setting up	6	6.2	Interface	22
2.4	Adjusting (calibration)	8	6.3	Optional equipment	22
3	Weighing	9	7	Appendix	23
3.1	On/off switching	9	7.1	Printout examples with LC-P45 and GA42 Printers	23
3.2	Simple weighing	9	7.2	Preventive maintenance	24
3.3	Taring	10	7.3	What if...?	25
3.4	METTLER TOLEDO DeltaRange balances	10	7.4	Index	26
4	Menu	11			
4.1	Overview	11			
4.2	Description of the menu options	12			

1 Getting to know the B balance line

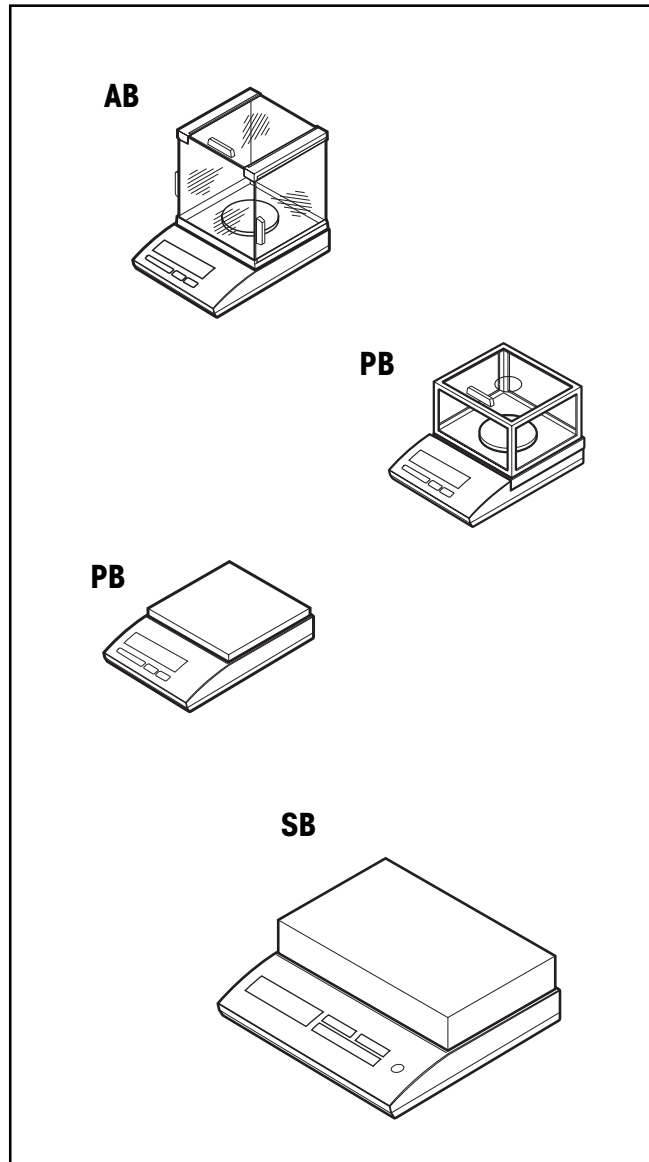

1.1 Introducing the B balance line

Several types of construction – uniform operation

The B balance line ranges from high-resolution analytical balances (AB balances) with a readability of 0.1 mg via precision balances (PB balances) up to industrial balances (SB balances) with a readability from 0.1 g to 1 g. The weighing ranges extend from 51 g to 32 kg.

The operation of all these balances is identical.

Performance capabilities

In addition to **basic weighing operations** such as weighing, taring and adjusting (calibration), the following **functions** can be activated (section 5):

- Piece counting
- Percent weighing
- Dynamic weighing for unstable weighing samples.

B balances can be optimally matched to the ambient conditions through appropriate setting of the **vibration adapter** (section 4.2.3).

METTLER TOLEDO **DeltaRange** balances also have a movable fine range with 10 times smaller display increments (section 3.4).

All B balances are fitted with an RS232C interface as standard (section 6.2).

Notes

- Certified versions of the B balances are also available, please ask your METTLER TOLEDO dealer for details.
- If you wish to build on what you have learned about weighing in these operating instructions, you will find valuable tips in the booklet "Weighing the right way" 720906.

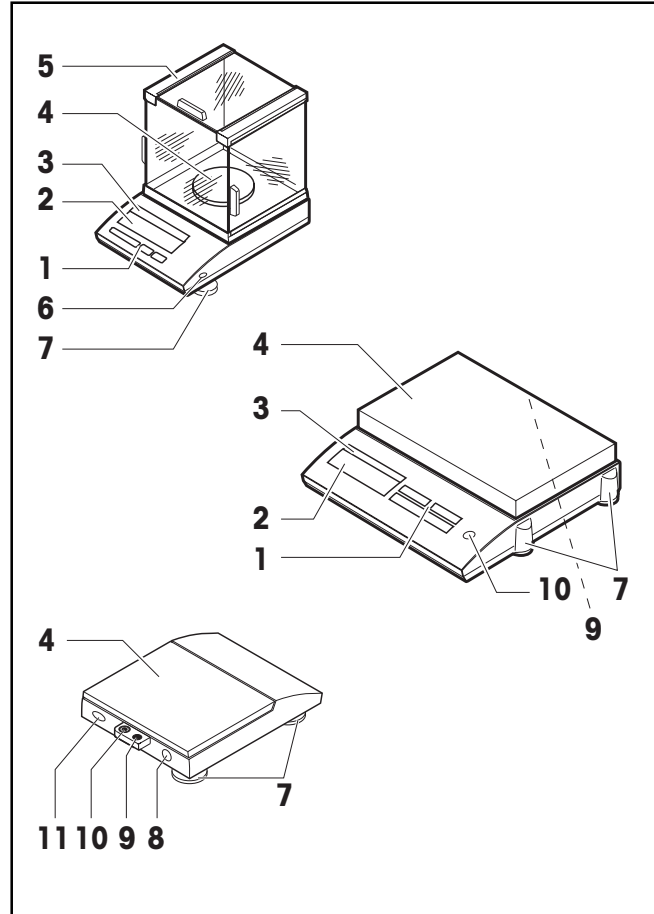

1.2 Layout of the B balances

- 1 Keys
- 2 Display
- 3 Model plate¹⁾
- 4 Weighing pan/platform
- 5 Draft shield
- 6 Certification switch for weights and measures inspector and service engineer
- 7 Leveling feet
- 8 AC adapter socket
- 9 Provision for antitheft device
- 10 Leveling control
- 11 RS232C interface

Keys, operation and display are identical for all B balances.

¹⁾ With details of

Max = maximum capacity

d = readability

* Min = minimum capacity (recommended minimum load for certified balances)

* e = verification scale interval (smallest display increment tested in certification)

* Relevant only for certified balances

1.3 The keys of the B balances (overview)

B balances have two operator control levels: the **weighing mode** and the **menu**. The keys have different meanings, depending on the operator control level and how long a key is pressed.

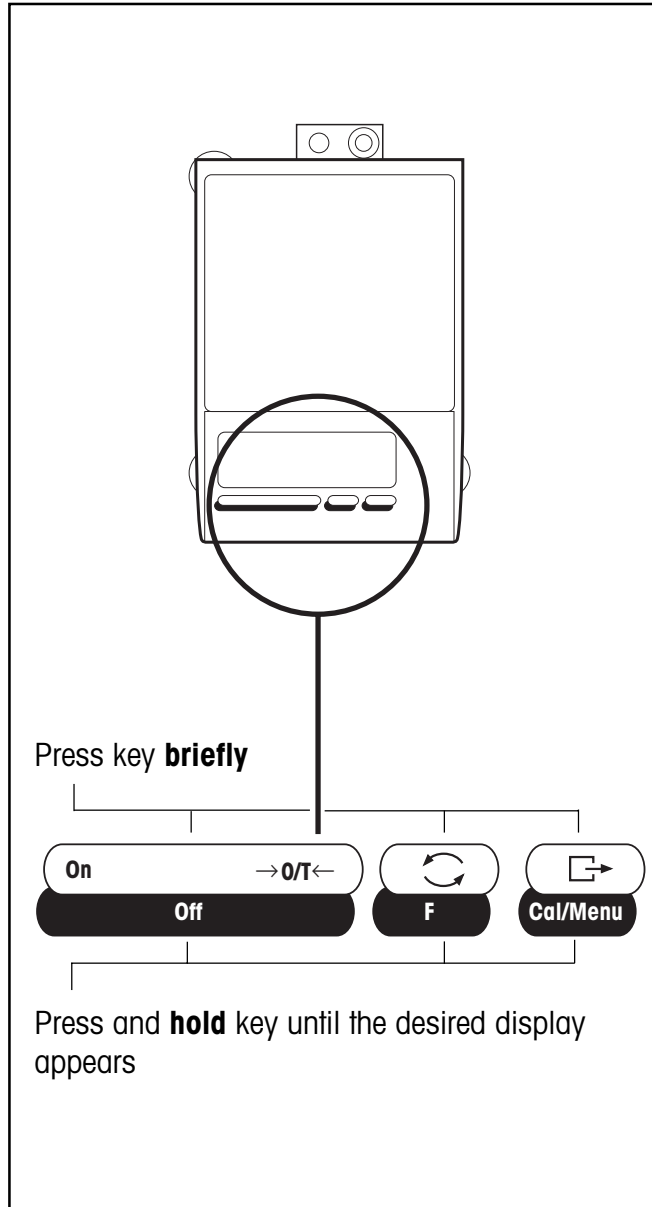

Weighing mode (operation)	
Press briefly	Press and hold
<ul style="list-style-type: none"> On • Switch on →0/T← • Tare 	<ul style="list-style-type: none"> Off • Switch off
<ul style="list-style-type: none"> ↶ • Switch ↷ • Change settings 	<ul style="list-style-type: none"> F • Call function A function must be activated in the menu, otherwise "F nonE" appears in the display.
<ul style="list-style-type: none"> ⇒ • Print ⇒ • Confirm settings 	<ul style="list-style-type: none"> Cal/Menu • Adjust (calibrate) Cal/Menu • Call menu

Menu (called up with Cal/Menu)	
Press briefly	Press and hold
<ul style="list-style-type: none"> →0/T← • Abort 	—
<ul style="list-style-type: none"> ↶ • Change settings 	—
<ul style="list-style-type: none"> ⇒ • Select menu options 	<ul style="list-style-type: none"> Cal/Menu • Store and quit menu

2 Startup

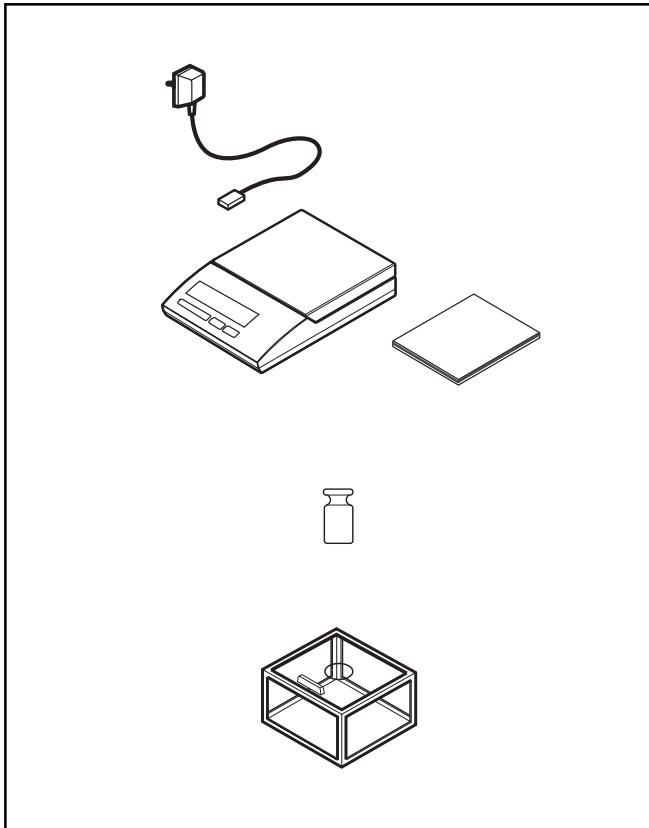

2.1 Unpacking / standard equipment

All B balances are supplied in an environmentally harmless package. The standard equipment of the B balances includes

- **AC adapter**, to national codes,
- **weighing pan**
- **operating instructions**, to allow optimum utilization of the capabilities of your balance,
- **Description of interface commands** (MT-SICS Reference Manual, available in English only)
- **calibration weight**, with AB balances only,
- **draft shield**, mounted with AB balances, for mounting by user in the case of PB balances with a round weighing pan.

Note

Adjusting weights can be ordered from METTLER TOLEDO for all other B balances, see section 6.2.

2.2 Cautionary notes

- B balances may not be operated in hazardous areas. ¹⁾
- Before attachment of the AC adapter, check whether the imprinted voltage value matches the local supply voltage. If it does not, contact your local dealer.

¹⁾ With the PS-EX2 power supply unit available as an accessory, all B balances can be used in hazard zone 2 (section 6.3).



2.3 Setting up

The optimum location

The correct location makes an important contribution to the accuracy of the weighing results of high-resolution analytical and precision balances.

Hence, ensure a

- stable, vibration-free position as horizontal as possible.

Avoid

- direct sunlight,
- excessive temperature fluctuations,
- drafts.

The best position is on a stable bench in a corner protected against drafts as far as possible from doors, windows, radiators or the ventilation slots of air conditioners.

Note

If vibrations can not be prevented, the balance can still provide accurate results if the vibration adapter is set accordingly, see section 4.2.3.

Antitheft device

B balances have provision for the attachment of an antitheft device.

The following antitheft devices are available:

- | | |
|-------------------------------|--------|
| • Bolt and lock (for AB, PB) | 229175 |
| • Cable lock (for all models) | 590101 |

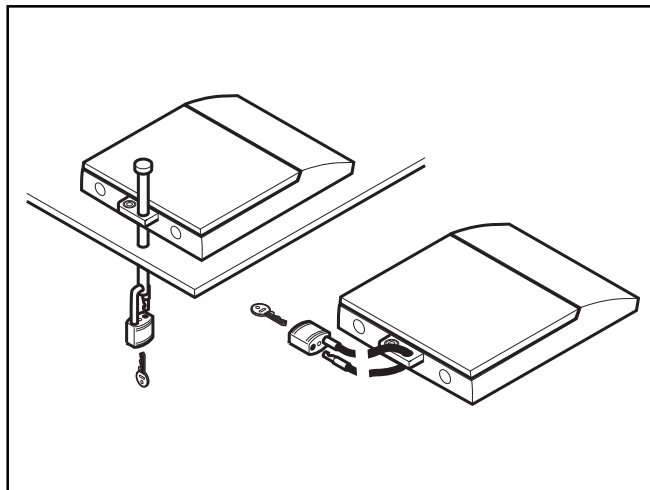
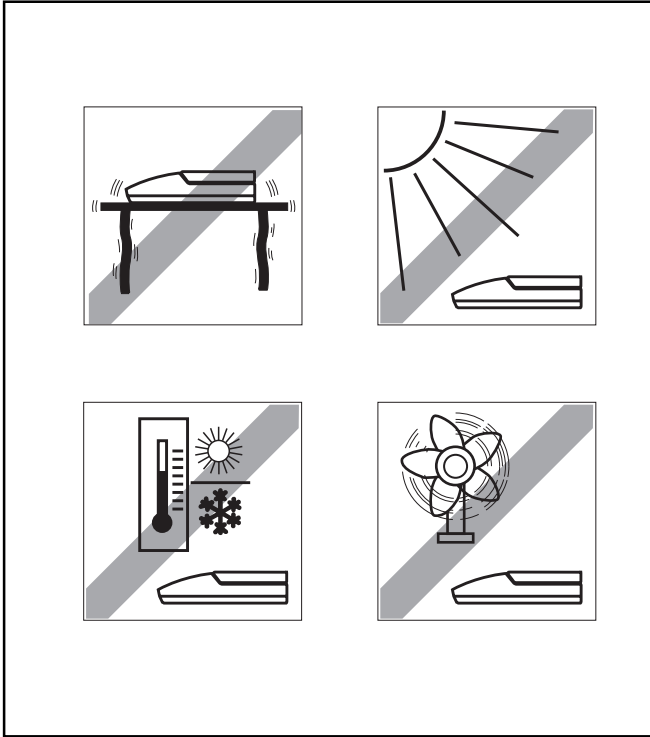

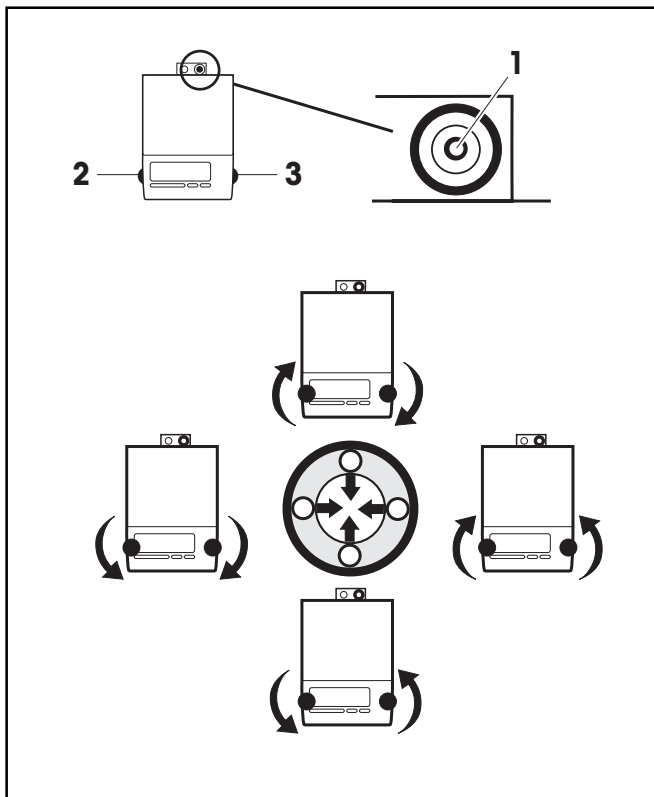

Leveling

B balances have a level control and adjustable leveling feet to compensate for slight irregularities in the weighing bench surface. The balance is exactly horizontal when the air bubble **1** is in the middle.

Procedure

Turn the two leveling feet 2 and 3 as shown in the diagram or described in the table so that air bubble **1** is in the middle.

Air bubble at "12-o'clock"	turn both leveling feet clockwise
Air bubble at "3-o'clock"	turn left leveling foot clockwise, right leveling foot counterclockwise
Air bubble at "6-o'clock"	turn both leveling feet counterclockwise
Air bubble at "9-o'clock"	turn left leveling foot counterclockwise, right leveling foot clockwise

Note

The balance must be leveled each time it is moved to a new location.

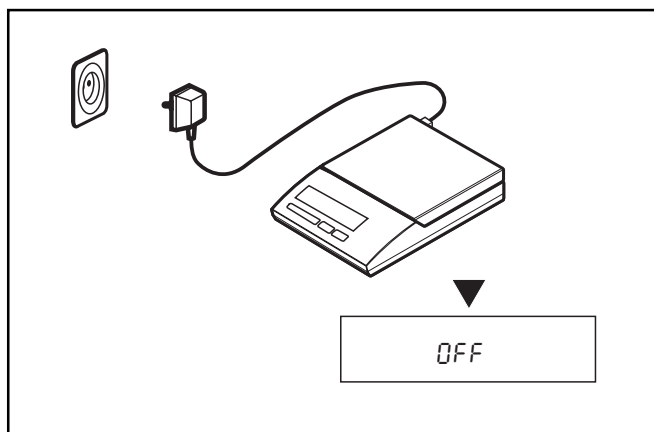

Connecting to the power supply

- Before connection of the AC adapter, check that the imprinted voltage value matches the local supply voltage. If this is not the case, please contact your local METTLER TOLEDO dealer.
- Plug AC adapter into AC adapter socket of the balance and connect to the power supply.
- The balance performs a self-test. The test is finished when "OFF" appears.
- Press briefly: balance is in operational readiness. Before any work is performed with the balance, it must be adjusted (calibrated), (section 2.4).

Notes

To achieve accurate results with analytical balances (AB), these must be connected to the power supply for 20–30 minutes to warm up to the operating temperature. The PP-B10 PowerPack (rechargeable, external battery) can be used to operate all B balances independently of the power supply (section 6.2).

2.4 Adjusting (calibration)

To obtain accurate weighing results, the balance must be matched to the acceleration due to gravity at its location.

Adjusting is necessary

- before the balance is used for the first time,
- at regular intervals during weighing operations,
- after a change in location.

Procedure

To obtain accurate results, before adjusting the balance must be switched on for 20–30 minutes so that the operating temperature will be reached.

- Have required adjusting weight ready (section 6.1).
- Unload weighing pan.
- Press and hold **Cal/Menu** until "CAL" appears in the display, release key. The required adjusting weight value flashes in the display.
- Place adjusting weight in center of pan. The balance adjusts itself.
- When "0.00" flashes, remove adjusting weight. The adjusting (calibration) is finished when "0.00 g" appears in the display. The balance is again in the weighing mode and ready for operation.

Note

- Depending on national certification specifications, the adjusting may be locked with **certified balances** after the installation.
- The adjustment can be terminated at any time using the **→ort←** key. The following message appears: Abort.

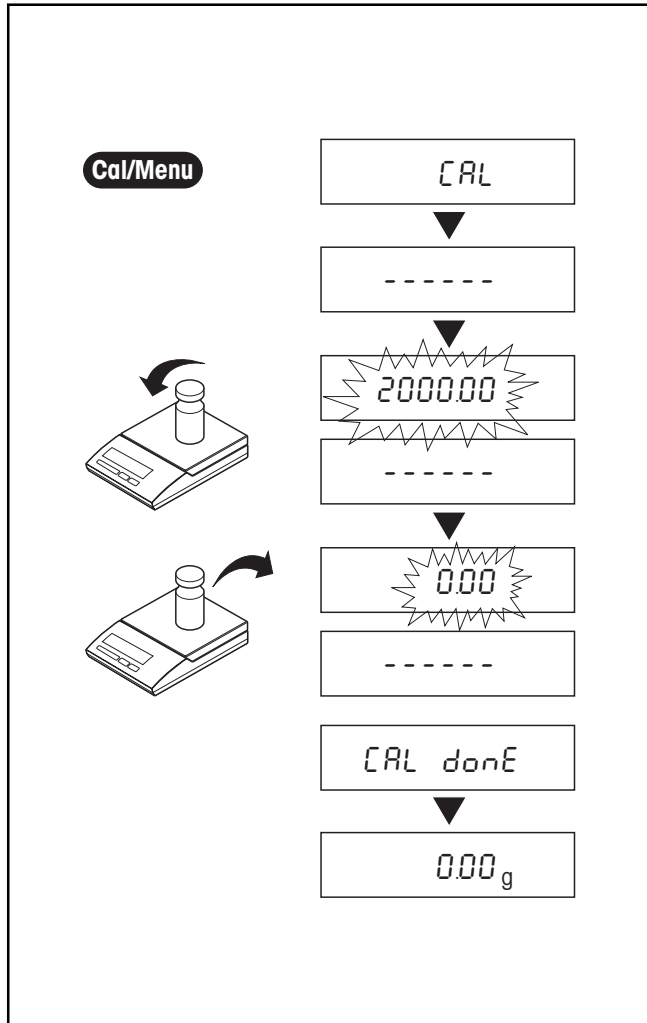

3 Weighing

3.1 On/off switching

Switching on

- Remove any load from weighing pan and press  briefly.
The balance performs a display test.
When zero is displayed, the balance is ready for operation.

Switching off

- Press and hold  until "OFF" appears in the display. Release key.

3.2 Simple weighing

- Place weighing sample on the weighing pan.
- Wait until the stability detector "o" disappears.
- Read result.

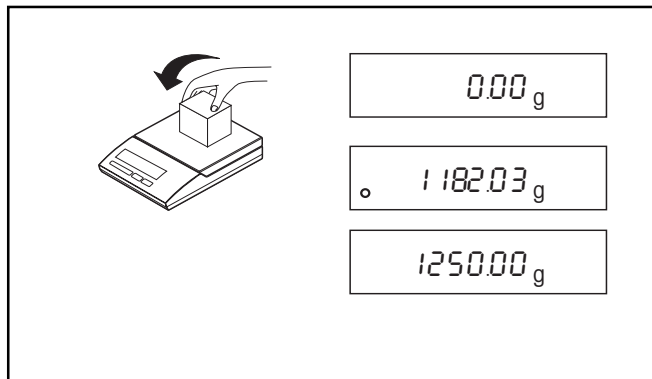
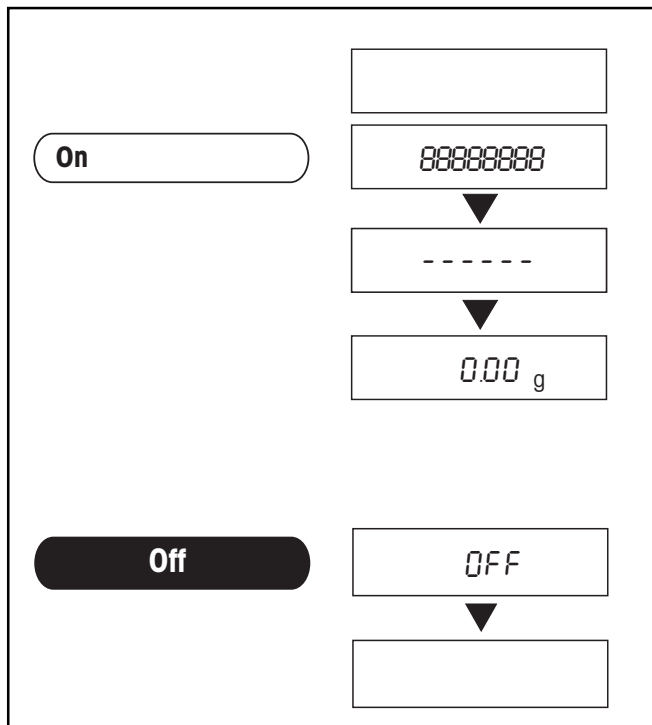

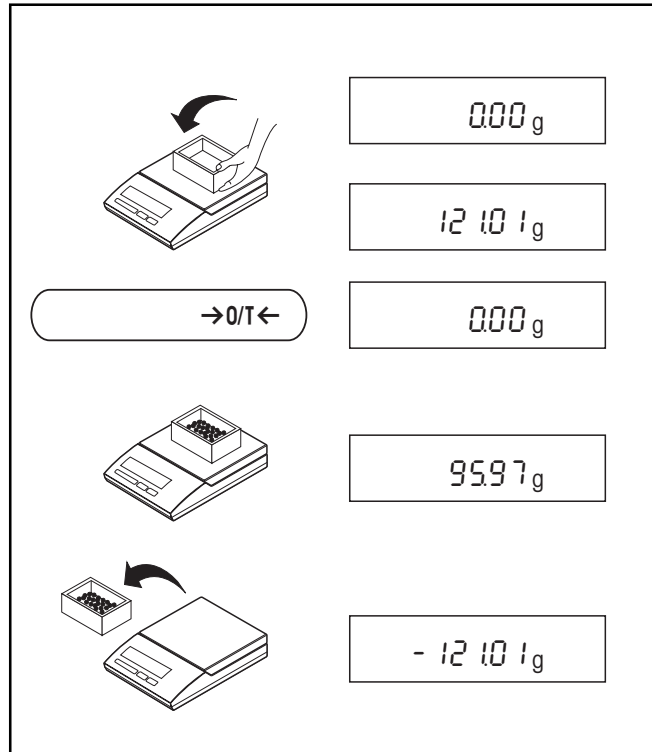

3.3 Taring

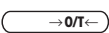
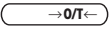
- Place empty container on the balance.
- The weight is displayed.
- Tare: press  briefly.
- Add weighing sample to container, the net weight is displayed.
If the container is removed from the balance, the tare weight will be shown as a negative value.
The tare weight remains stored until  is again pressed or the balance is switched off.

Note

With METTLER TOLEDO DeltaRange balances, the fine range with its 10 times smaller display increments is again available after every taring operation.

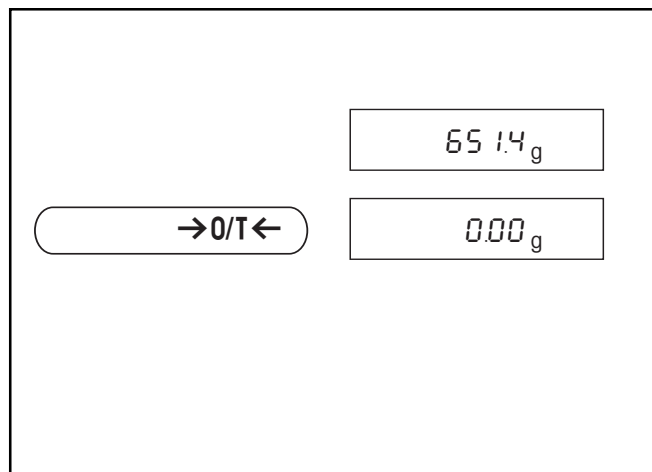

3.4 METTLER TOLEDO DeltaRange balances

METTLER TOLEDO **DeltaRange balances** have a movable fine range with 10 times smaller display steps. In this range there is always an additional decimal place in the display.

The balance operates in the fine range

- after switching on,
- after every taring operation.

If the fine range is exceeded (section 6.1), the balance display automatically switches to greater display steps.

4 Menu

4.1 Overview

You can use the menu to activate functions (F) and change the balance settings. With **certified** balances/scales, the unit selection can be blocked following installation if required by national legislation. A detailed description of the menu options is given in sections 4.2.

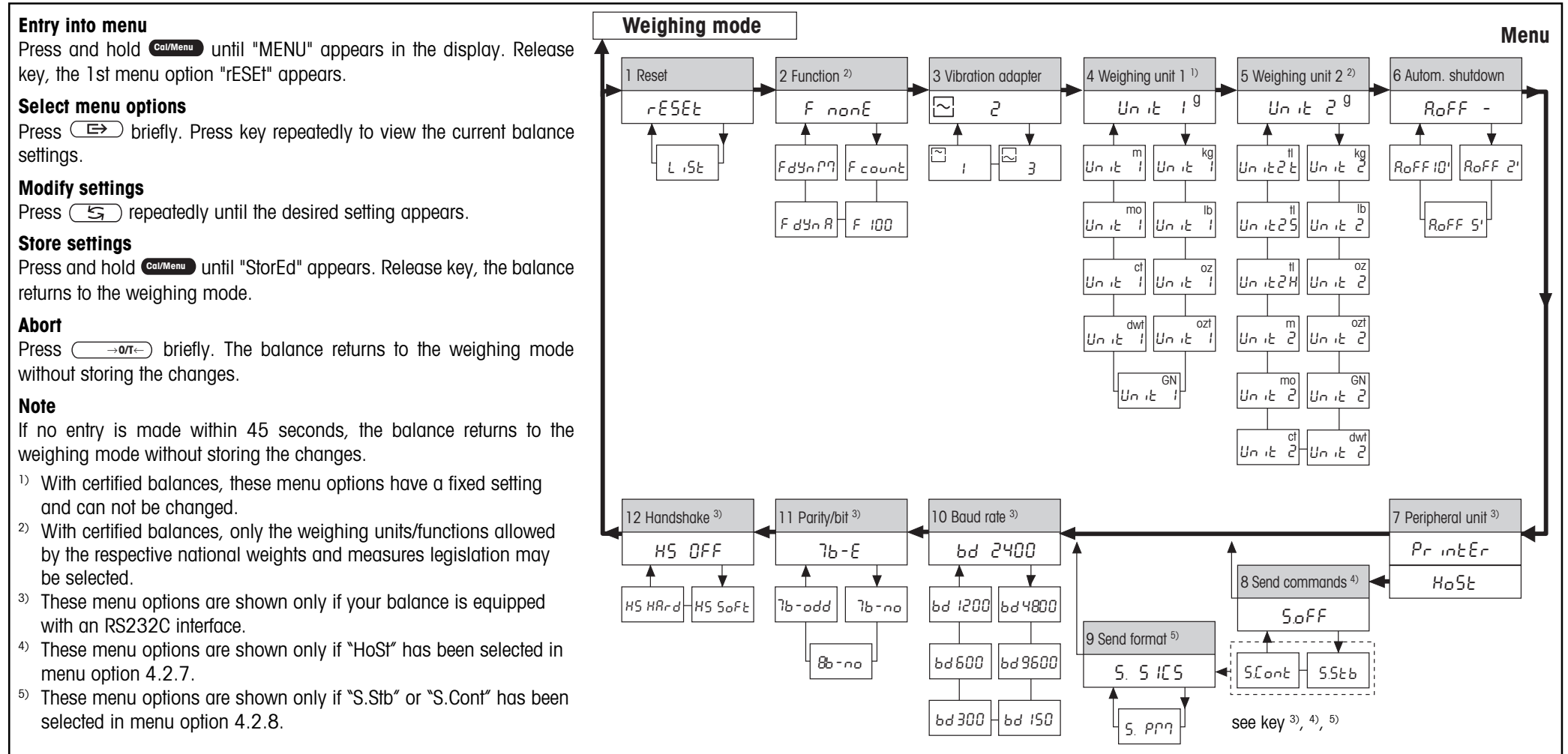

4.2 Description of the menu options

4.2.1 Reset and printout of the balance setting

Reset balance setting and functions to factory setting (rESEt)

→ Select "rESEt" and press and hold **Cal/Menu** until "r donE" is displayed.
The balance is now reset to the factory setting and returns to the weighing mode.

F nonE	no function activated	PrintEr	Attachment to printer or host
2	normal balance environment	bd2400	Transmission rate
Unit 1	g	7b-E	Character format
Unit 2	g	HS oFF	Transmission protocol
A. oFF	no automatic shutdown		

Printing out the balance setting (LISt)

→ Select "LISt" and press and hold **Cal/Menu** until "StorEd" is displayed.
The current balance setting is printed out and stored.

4.2.2 F... – Selecting function of F key (detailed description in section 5)

In addition to simple weighing, the following functions can be selected:

F nonE	No function, simple weighing (factory setting)
F count	Piece counting
F 100 %	Percent weighing
F dYn A	Dynamic weighing with automatic start
F dYn M	Dynamic weighing with manual start

4.2.3 Setting the vibration adapter

You can use the vibration adapter to match the balance to the ambient conditions.

2	Setting with normal balance surroundings (factory setting).
3	Setting with unstable balance surroundings. The balance operates slower but is less sensitive to external influences (drafts, vibrations, etc.).
1	Setting with very stable balance surroundings. The balance operates very quickly but is sensitive to external influences (drafts, vibrations, etc.).

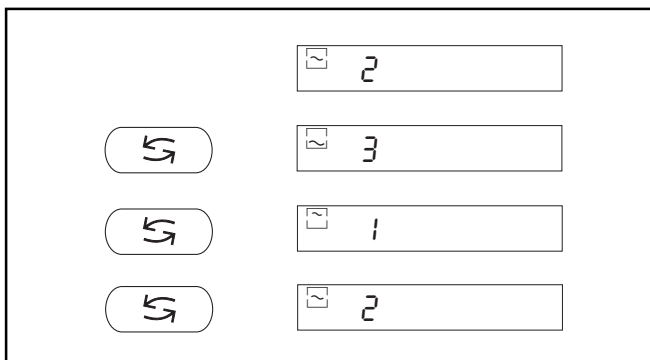
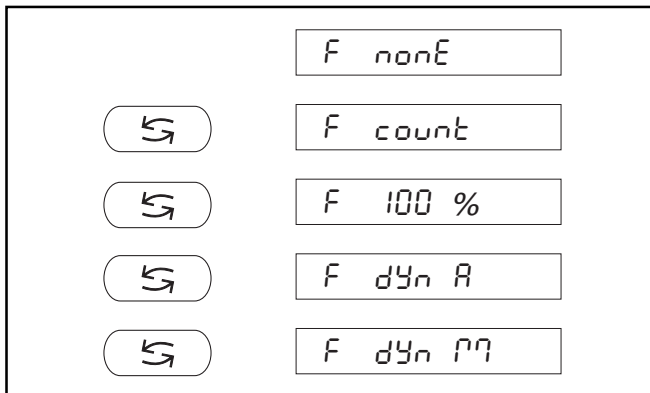
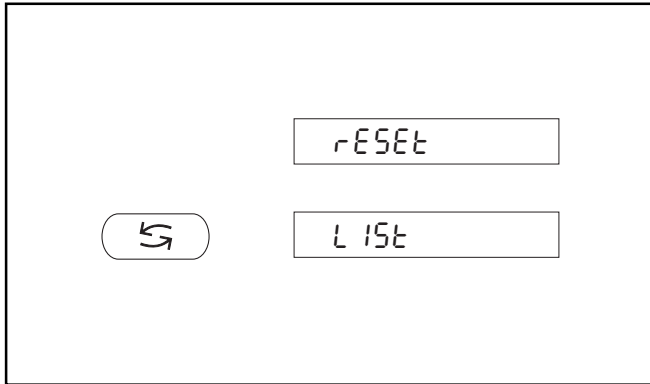

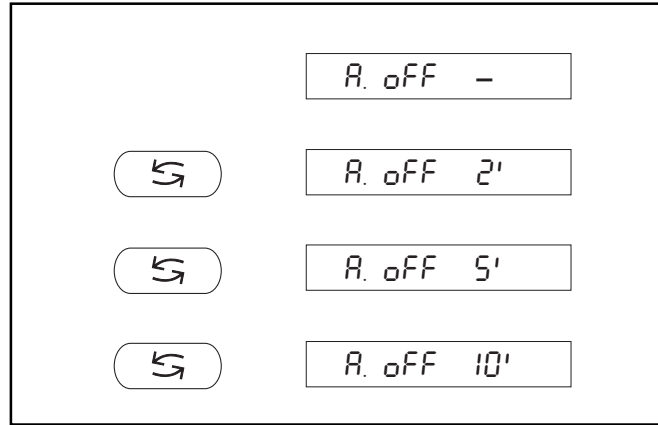
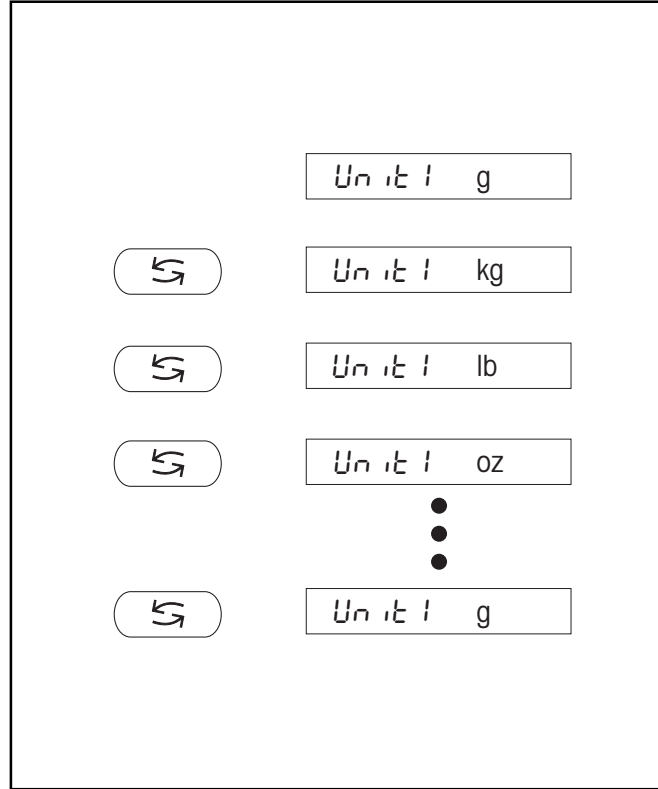

4.2.4 Selecting unit 1

Depending on requirements, the balance can operate with the following units:

Unit	Conversion factor	Comments
g	gram	factory setting
kg	kilogram	not with 1 mg balances
lb	pound	not with 0.1 mg balances
oz	ounce	
ozt	troy ounce	
GN	grain	not with 1 g balances
dwt	pennyweight	
ct	carat	
mg	milligram	only with 0.1 mg and 1 mg balances
mo	momme	
m	Mesghal	
H tl	Hong Kong taels	selectable only in unit 2
S tl	Singapore taels	selectable only in unit 2
t tl	Taiwan taels	selectable only in unit 2

4.2.5 Selecting unit 2

If the weighing results should be shown in a different unit in the weighing mode by pressing , the appropriate unit must be selected in the menu.

4.2.6 A. off – automatic shutdown

The automatic shutdown extends the operating time in line-independent operation with the PP-B10 PowerPack considerably.

When the automatic shutdown is activated, the balance switches itself off if no weighing has been performed during the specified time. With the PowerPack the balance is then off, without the PowerPack it is on standby.

A. off – no automatic shutdown (factory setting)

A. off 2 automatic shutdown after 2 minutes

A. off 5 automatic shutdown after 5 minutes

A. off 10 automatic shutdown after 10 minutes

	Pr intEr
↵	HoSt

4.2.7 Selecting peripheral device

In this menu option you can select the desired peripheral device. The balance automatically stores the appropriate settings for every peripheral device.

- Printer Attachment to a printer (e.g. METTLER TOLEDO GA42 Printer), (section 6.2).
Factory setting: bd 2400, 7b-E, HS oFF
- Host Attachment to any peripheral device.
Factory setting: bd 9600, 8b-no, HS SoFt

	S. oFF
↵	S. Stb
↵	S. Cont

4.2.8 Selecting data transfer mode

In this menu block you tell the balance how a value should be transferred to a peripheral device (e.g. computer). This menu option appears only if the setting "HoSt" has been selected in the menu option "Selecting peripheral device".

- S. oFF Data transfer mode switched off
- S. Stb The next possible stable value will be transferred after triggering of the Print/Transfer command.
- S. Cont All values will be automatically transferred.

	S. SICS
↵	S. PM

4.2.9 Selecting data transfer format

With the "S. SICS" setting the data transfer formats described in MT-SICS are used. You will find the description in the enclosed description of the operating instructions (Reference manual MT-SICS).

With the "S. PM" setting the following data transfer formats of the PM balances are used.

- S. Stb: -----1.67890-g
- S. Cont: S-----1.67890-g
- SD---1.39110-g

Note

If you wish to use other data transfer formats of the PM balances with your B-balance, please use the optional B-M emulation software which emulates all interface commands of the PM balances (see section 6.3).

The interface is **unidirectional**. Incoming interface commands in the setting "S. PM" are not processed further.

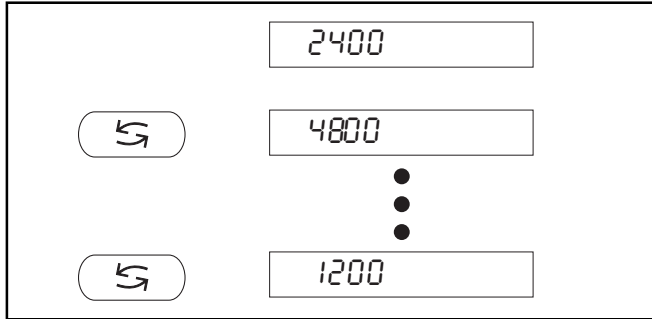

4.2.10 Setting baud rate (data transmission rate)

The data transmission rate (baud rate) determines the speed of the transmission via the serial interface. The unit is baud (1 baud (bd) = 1 bit/second).

The following settings are available: 150 bd, 300 bd, 600 bd, 1200 bd, 2400 bd, 4800 bd and 9600 bd.

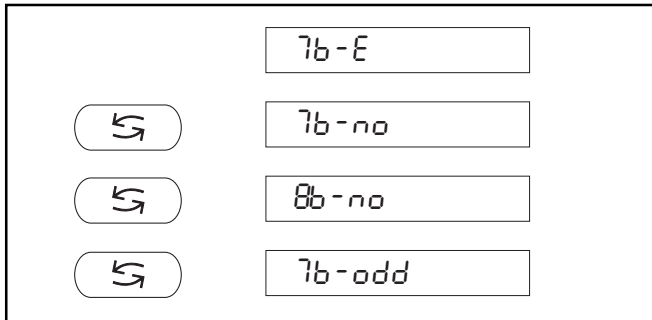

4.2.11 Setting parity/bits

In this menu option you can set the character format for the attached peripheral device.

7b-E 7 bits/even parity

7b-no 7 bits/no parity

8b-no 8 bits/no parity

7b-odd 7 bits/odd parity

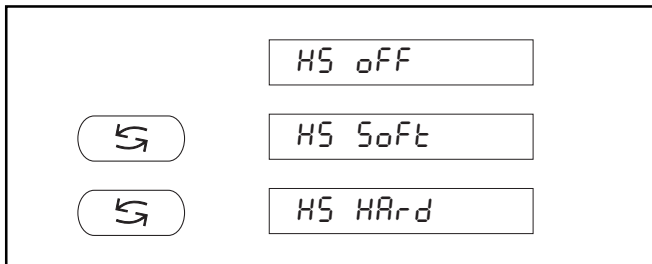

4.2.12 Setting handshake

This menu option allows you match the data transmission to different serial receivers.

HS oFF No handshake

HS SoFt Software handshake (XON/XOFF)

HS HARd Hardware handshake (DTR/CTS)

Note

If you have selected the setting "HS HARd", the attached peripheral device must be switched on. If it is switched off, the balance is blocked.

5 Functions

5.1 Piece counting

Requirement

The function "F count" must be activated in the menu, see section 4.

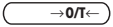
→ Place empty container on the balance and tare: press  briefly.

Setting the reference

A reference weight (reference) must first be entered for piece counting.

→ Add reference parts to container, possible reference numbers are 10, 20, 30, 50, 100 and 5.

→ Press and hold  until "SEt ... PCS" is displayed.

→ Press  repeatedly until the display matches the loaded reference number.

→ Press  briefly to confirm reference or automatic acceptance after 2 seconds. The current piece number (PCS = pieces) is displayed.

Notes

- The current reference weight remains stored until the reference is reset or the power supply is interrupted.





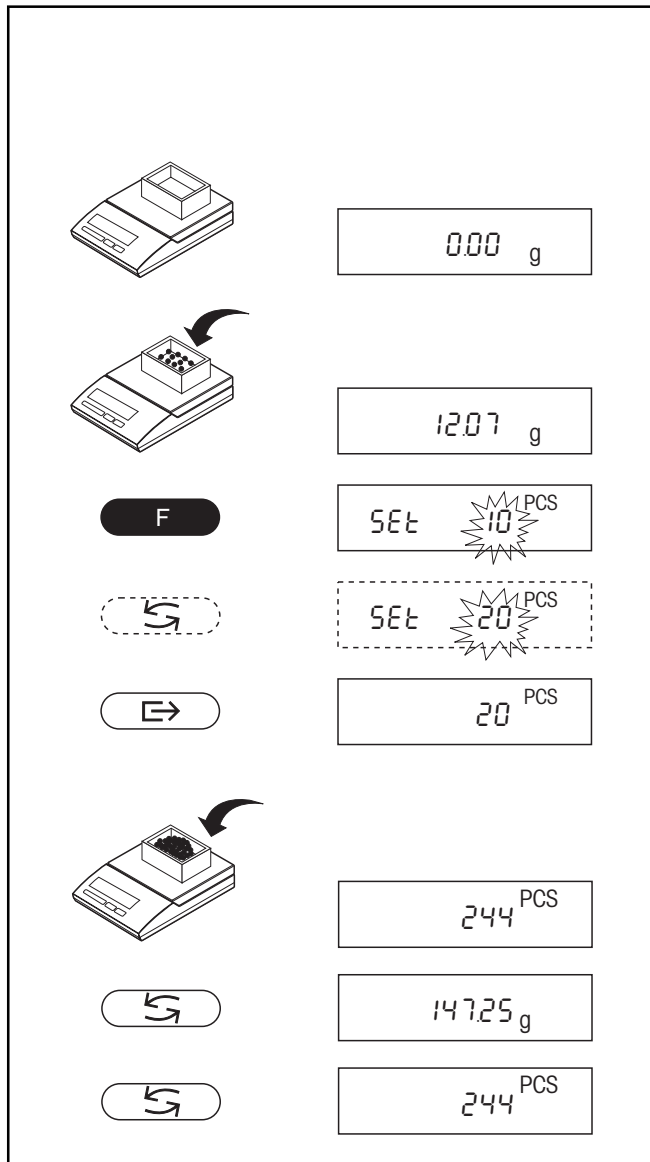

Counting / switching

→ Add weighing sample to the container and read piece number.

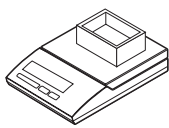
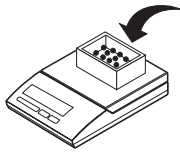
→ Press  briefly, the weight is displayed.

→ Return to display of the piece number: press  again.

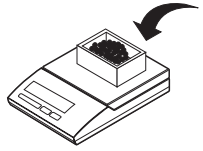

	0.00 g
	12.07 g
	SEt 10 ^{PCS}
	SEt 20 ^{PCS}
	20 ^{PCS}
	244 ^{PCS}
	147.25 g
	244 ^{PCS}

5.2 Percent weighing

Requirement

The function "F 100 %" must be activated in the menu (see section 4).

Set target weight

- Place target weight in center of pan.
- Press and hold **F** until "SEt 100 %" appears in the display.
- Press **↵** briefly to confirm or automatic acceptance after 2 seconds. The target weight is specified.

Notes

- The current target weight remains stored until a new target weight is set or the power supply is interrupted.

Percent weighing / switching

- Place weighing sample in center of pan.
The weight of the sample is displayed as a percentage of the target weight.
- Press **↵** briefly, the weight is displayed.
- Return to display in percent: press **↵** briefly again.

The diagram illustrates the process of setting a target weight and switching to percent weighing on a scale. It is divided into two sections, each showing a sequence of actions and the corresponding display.

Top Section: Setting Target Weight

- Initial display: 0.00 g
- Weight is placed on the pan. Display: 148.50 g
- Press and hold the **F** button. Display: SEt 100 %
- Press the **↵** button. Display: 100.0 %

Bottom Section: Percent Weighing / Switching

- Weighting sample is placed on the pan. Display: 10.15 %
- Press the **↵** button. Display: 150.88 g
- Press the **↵** button again. Display: 10.15 %

5.3 Dynamic weighing

Dynamic weighing is suitable for the weighing of unstable weighing samples. The mean value of the weighing results is determined over a specified time period (weighing time). The more unstable the weighing sample, the longer the selected weighing time.



Requirement

"F dYn A" for automatic start or "F dYn M" for manual start must be activated in the menu (section 4).
Factory setting is a weighing time of 3 seconds ($t = 3$).

Tare container



→ Tare:  key.

Dynamic weighing with automatic start (F dYn A)

- Select dynamic weighing with the  key. The display shows the symbol .
- Load weighing sample. As soon as the balance is relatively stable, weighing starts automatically. During the weighing time, a "count down" runs in the display.

- Read off result.
The result of the dynamic weighing is displayed with * (= calculated value) and remains in the display until the weighing sample is removed from the weighing pan or the container.

Notes

- The weighing cycle with the same weighing sample can be restarted with the  key.
- The  key can be used to switch between dynamic weighing and normal weighing.
- For weighing goods below 5 g, use dynamic weighing with **manual** start.

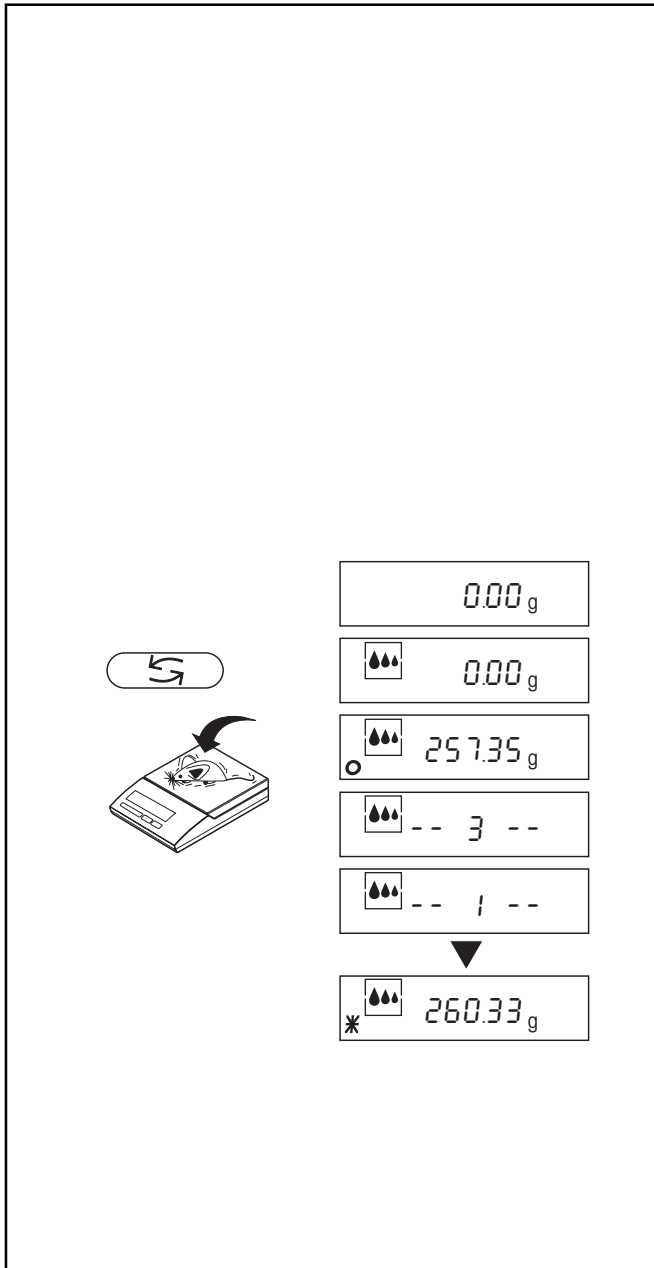

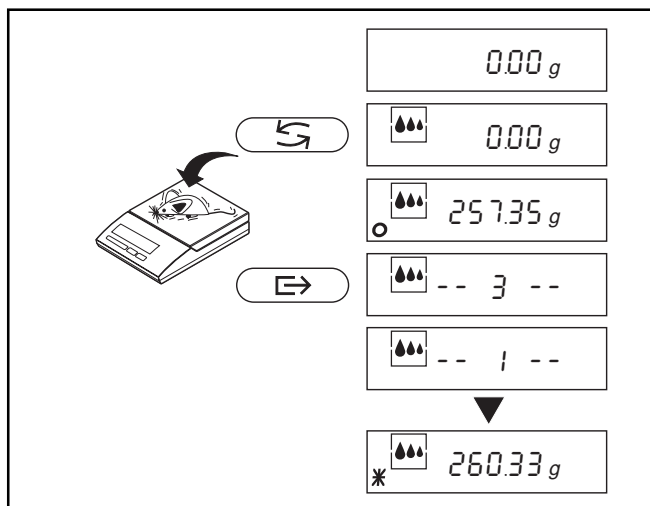

Dynamic weighing with manual start (F dYn M)

- Place empty container on the balance and tare. Press .
- Switch to dynamic weighing. Press . The display shows .
- Add weighing sample to container.
- Start weighing with . During the weighing time, a "count down" runs in the display.
- Read off result. The result of the dynamic weighing is indicated by * (= computed value) and remains in the display until the weighing sample is removed from the weighing pan.

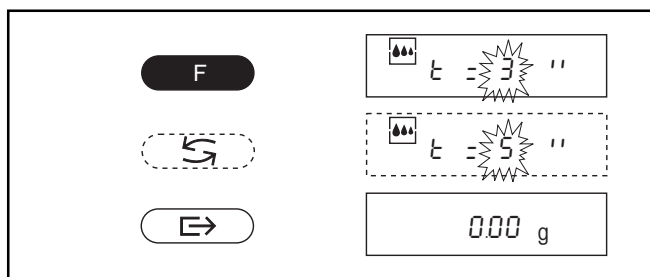

Changing the weighing time

- Press and hold **F** until "t = 3" appears in the display.
- Press repeatedly until the desired weighing time appears. Possible values are 3", 5", 10", 20", 1", 2".
- Press briefly to confirm selection or by automatic acceptance after 2 seconds.

Notes

- The set weighing time remains stored until it is reset or the power supply fails.

5.4 Switching weight units

Requirement

Different weight units must be activated in the menu for unit 1 and unit 2 (section 4). This function is not available with dynamic weighing.

Switching between unit 1 and unit 2

- Press briefly. Switching between weight units may be blocked with certified balances, depending on the national weights and measures legislation.

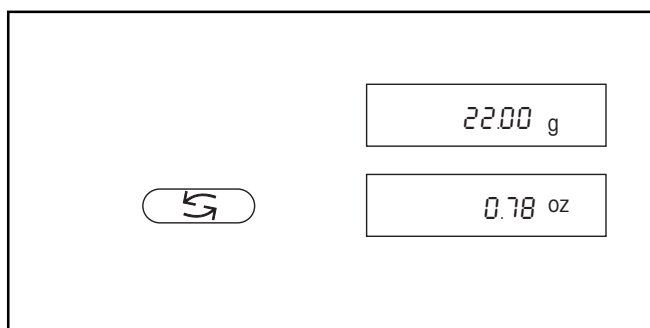

6 Technical data and optional equipment

6.1 Technical data

Standard equipment of the B balances

- Protective cover
- AC adapter to national codes
(Power supply: 115 V/230 V, -20/+15%, 50/60 Hz, 65/30 mA, 6 VA)
(Power supply balance: 8–14.5 V, 50/60 Hz or 9.5–20 V = 1.5 VA)
- Device for weighing below the balance for AB and PB balances. With SB balances, this device is an optional accessory.

- Adjusting weight with AB balances
- RS232C interface

Degree of protection

- Protects against dust and water.
- Pollution degree: 2
- Overvoltage category: II

Ambient conditions

The technical data are valid under the following ambient conditions:

- Ambient temperature 10 °C...30 °C
- Relative atmospheric humidity 15 %...85 %, noncondensing
- Height above sea level up to 4000 m

The operability is assured between ambient temperatures 5–40°C.

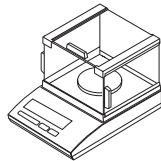

AB54

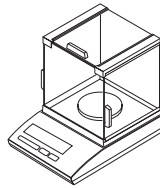

AB104

AB204

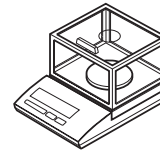

PB153

PB303

**PB303
DeltaRange**

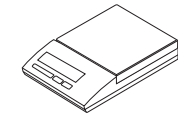

PB302

PB602

PB1502

	AB54	AB104	AB204	PB153	PB303	PB303 DeltaRange	PB302	PB602	PB1502
Readability	0.1 mg	0.1 mg	0.1 mg	0.001 g	0.001 g	0.001 g*/0.01 g	0.01 g	0.01 g	0.01 g
Maximum capacity	51 g	101 g	210 g	151 g	310 g	60 g*/310 g	310 g	610 g	1510 g
Repeatability (s)	0.1 mg	0.1 mg	0.1 mg	0.001 g	0.001 g	0.001 g*/0.005 g	0.01 g	0.01 g	0.01 g
Linearity -/+	0.2 mg	0.2 mg	0.3 mg	0.002 g	0.003 g	0.002 g*/0.02 g	0.02 g	0.02 g	0.02 g
Adjusting weight	50 g	100 g	200 g	100 g ¹⁾	200 g ¹⁾	200 g ¹⁾	200 g ¹⁾	500 g ¹⁾	1000 g ¹⁾
Adjusting weight with certified balances	50 g	100 g	200 g	150 g ¹⁾	300 g ¹⁾	300 g ¹⁾	- ²⁾	600 g ¹⁾	1500 g ¹⁾
Overall dimensions (WxDxH) in mm	190x290x265	190x290x339		190x290x204			190x290x62		
Weighing pan in mm	ø 80	ø 80		ø 100			180x166		
Max. height above weighing pan	159 mm	232 mm		118 mm					
Net weight (with packaging)	4.6 kg (7.3 kg)	5 kg (8.1 kg)		3 kg (5 kg)			2.5 kg (4.5 kg)		

* Fine range values (DeltaRange)

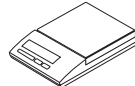
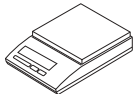

¹⁾ Optional equipment

²⁾ Not available as certified version

Technical data								
	PB3002	PB3002 DeltaRange	PB801	PB1501	PB3001	PB5001	PB8001	PB8000
Readability	0.01 g	0.01 g*/0.1 g	0.1 g	0.1 g	0.1 g	0.1 g	0.1 g	1 g
Maximum capacity	3100 g	600 g*/3100 g	810 g	1510 g	3100 g	5100 g	8100 g	8100 g
Repeatability (s)	0.01 g	0.01 g*/0.05 g	0.05 g	0.05 g	0.05 g	0.05 g	0.1 g	0.5 g
Linearity -/+	0.03 g	0.02 g*/0.1 g	0.1 g	0.1 g	0.1 g	0.1 g	0.1 g	0.5 g
Adjusting weight ¹⁾	2000 g	2000 g	500 g	1000 g	2000 g	2000 g	4000 g	2000 g
Adjusting weight with certified balances ¹⁾	3000 g	3000 g	800 g	1500 g	3000 g	5000 g	8000 g	8000 g
Overall dimensions (WxDxH) in mm	190x290x62					190x290x82		
Weighing pan in mm	180x166					175x166		
Net weight (with packaging)	2.5 kg (4.5 kg)					2.7 kg (4.2 kg)		

* Fine range values (DeltaRange)

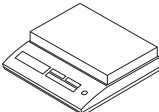
¹⁾ Optional equipment

Technical data									
	SB8001	SB12001	SB16001	SB16001 DeltaRange	SB24001 DeltaRange	SB32001 DeltaRange	SB8000	SB16000	SB32000
Readability	0.1 g	0.1 g	0.1 g	0.1 g*/1 g	0.1 g*/1 g	0.1 g*/1 g	1 g	1 g	1 g
Maximum capacity	8100 g	12100 g	16100 g	3200 g*/16100 g	4800 g*/24100 g	6400 g*/32100 g	8100 g	16100 g	32100 g
Repeatability (s)	0.1 g	0.1 g	0.1 g	0.1 g*/0.5 g	0.1 g*/0.5 g	0.1 g*/0.5 g	0.5 g	0.5 g	0.5 g
Linearity -/+	0.2 g	0.3 g	0.3 g	0.3 g*/0.5 g	0.3 g*/0.5 g	0.3 g*/0.5 g	0.5 g	0.5 g	0.5 g
Adjusting weight ¹⁾	4 kg	4 kg	4 kg	4 kg	4 kg	4 kg	4 kg	4 kg	4 kg
Adjusting weight with certified balances ¹⁾	8 kg	12 kg	16 kg	16 kg	24 kg	32 kg	8 kg	16 kg	32 kg
Overall dimensions (WxDxH) in mm	381x321x92								
Weighing pan in mm	349x232								
Net weight (with packaging)	6.8 kg (8.3 kg)								

* Fine range values (DeltaRange)

¹⁾ Optional equipment

6.2 Interface

RS232C interface and interface accessories

Every B balance is fitted with an RS232C interface for attachment to a peripheral device (e.g. printer or PC with a 9-pin male connector). Matching to a different device can be carried out in the menu (sections 4.2.7–4.2.10).

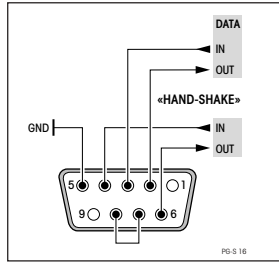

You will find a detailed description of the available interface commands in the enclosed brochure "Reference Manual MT-SICS, available in English only)

The wide range of features of the B balances regarding

documentation of the results can not be exploited to the full until a printer, e.g. the GA42 or LC-P45 from METTLER TOLEDO is attached. The printed results make a decisive contribution to a simple way of working in compliance with GLP/GMP.

Printers with normal paper

- Application printer with adjustment, statistics and multiplication function as well as time and date, 24 characters LC-P45
- Simple printer, 24 characters, without time/date GA42

Cables and cabling accessories

- RS9-RS25: (m/f), length 2 m 11101052
- RS9-RS9: (m/f), length 1 m 11101051
- RS9-RS9: (m/m), length 1 m 21250066

6.3 Optional equipment

Adjusting weights

Available as **OIML** weights (E1) (E2, F2 with certificate) for further details, see METTLER TOLEDO weights brochure 721192
or as **adjusting** weights (not OIML)

Draft shields

AB54 224371
AB104, AB204 224370
PB153, PB303, PB303DR 224372
Note: AB54 and AB104 draft shields can also be used for PBxx3 models.

Protective covers (set of 3)

AB54-204 228183
PB153-303 224007
PB302-3001 224008
PB5001-8000 228182
SB models 230018

Dust covers for AB104, 204 238465

AC adapters

Euro (230 V) 228063
Euro (ground contact) (230 V) 228198
UK (240 V) 228066
US (120 V) 228064
Japan (100 V) 228065
Australia (bench version) (240 V) 228190

Hazard Zone 2

Standard AB, PB, SB models are not compliant for Hazard Zones 0, 1 or 2.

For Explosion Zone 2, only the special versions ../02 and ../03 (same features) are ready for compliance.

It is not allowed to use them for EX-Zone 1 and 0.

All models are available in approved versions.

Following accessories are available for the use of the balance in Explosion Zone 2:

- Special AC adapter PS-EX2 (compulsory) 21200182
- Optical isolator RS-OPTOEX2 for data export 224265

PowerPack

Line-independent, rechargeable external power source, for 10 hours weighing operation (see section 4.2.6) PP-B10

Connection plate PowerPack/balance

long, for PB, SB 230166
short, for SB 230168

Hook for weighing below the balance

for all SB models 21301097

Density kits (for AB only)

- For determination of solids 33360
- For determination of liquids with displacement body 33360+210260

Transport case

for all PB models, accommodation for balance and PowerPack 224009
for all SB models, accommodation for balance and PowerPack 230031

Antitheft devices (see also section 2.3)

- Cable with lock (for all models) 590101
- Bolt and lock (for AB, PB) 229175

B-M emulation 21301730

Software EPROM for the use of B balances in systems together with METTLER TOLEDO PM balances

7 Appendix

7.1 Printout examples with LC-P45 and GA42 Printers

• Functions triggered by balance

Function: **Adjusting**

```

-- BALANCE CALIBRATION -
Date: .....
Time: .....

METTLER TOLEDO
Balance
Type:          PB3002DR
SNR:          1116150017

Weight ID: .....
Weight:        2000.00 g

Ext. calibration done

Signature:
.....
----- END -----

```

Function: **Piece counting**

Printout of reference weight

```

---- PIECE COUNTING ----

APW      10.0000000 g
Out of:   10 PCS

          110 PCS

Net      1100.1 g

----- END -----

```

Function: **List**

Printout of the current balance settings

```

----- LIST -----
Date: .....
Time: .....

METTLER TOLEDO
Balance
Type:          PB3002DR
SNR:          1116150017

SW-Ver.: 1.70 2.0
Funct.: none
Vibr.: 2
Unit 1: g
Unit 2: g
A.Off: -
Output: Printer
Baud: 2400
Bit: 7
Parity: even
Handshake:off
----- END -----

```

Function: **Percent weighing**

Printout of reference weight

```

95.00 g = 100 %
1100.0 %

```

• Functions triggered by printer¹⁾

Function: **Adjusting**

With automatic insertion of date and time

```

-- BALANCE CALIBRATION -
08.04.97      15:13:37

METTLER TOLEDO
Balance
Type:          PB3002DR
SNR:          1116150017

Weight ID: .....
Weight:        2000.00 g

Ext. calibration done

Signature:
.....
----- END -----

```

Function: **Verification**

With automatic insertion of date and time, with fixed weight (calibration weight)

```

---- BALANCE TEST ----
08.04.97      15:14:22

METTLER TOLEDO
Balance
Type:          PB3002DR
SNR:          1116150017

Weight ID: .....

Target: .....
Actual:        2000.01 g
Diff: .....

External test done

Signature:
.....
----- END -----

```

Function: **Statistics**

```

08.04.97      15:18:55
ID            45.698-3
SNR:         1116150017

1            100.00 g
2            100.01 g
3            100.01 g
4            100.00 g
5            100.00 g
n            5
x            100.004 g
s            0.005 g
srel         0.01 %
min.         100.00 g
max.         100.01 g
dif.         0.01 g

----- END -----

```

Function: **Multiplier**

With rounding to the nearest 5.

```

08.04.97      15:21:50
ID            45.698-3
SNR:         1116150017

Factor        1.650
              99.99 g
*            164.9835

```

¹⁾ possible only with LC-P45

7.2 Preventive maintenance

Servicing

Regular servicing of your balance by a service engineer extends its life. Ask your METTLER TOLEDO dealer for details of the servicing possibilities.

Cleaning

The balance housing and the weighing pan are made of high-grade, resistant materials. All usual cleaning agents can thus be used.

Soiled protective covers can be replaced for all balance types, see optional equipment in section 6.2.



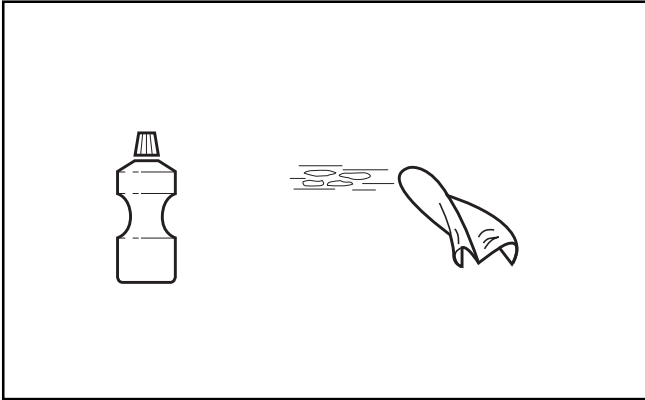

Note

After working with chemicals, it is advisable to wash or clean the weighing pan and the baseplate (if draft shield fitted).

Although all materials are of high quality, corrosion may occur if corrosive substances are stored for a lengthy period of time (and on exclusion of air, e.g. by a coat of grease) on chrome steel.

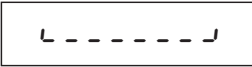

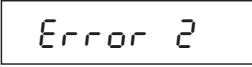
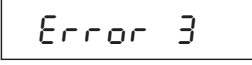
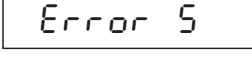
7.3 What if...?

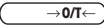
Error/error message	Cause	Rectification
	Overload	→ Remove sample from weighing pan, rezero (tare).
	Underload	→ Check whether weighing pan is positioned properly.
	No stability <ul style="list-style-type: none"> • in taring or adjusting (calibration) • when reference weight for piece counting or percent weighing is placed on the pan 	<ul style="list-style-type: none"> → Wait for stability before pressing key. → Ensure more stable ambient conditions.
	No or wrong adjusting weight on pan	→ Place required adjusting weight in center of pan.
	Reference weight or reference number too small	→ Increase reference weight or piece number.
	Balance/scale software not sufficiently up-to-date for operation with LC-B interface.	→ To change the balance/scale software 299702 (Order No. 600150), ask your METTLER TOLEDO dealer.
	Wrong or no weighing pan	→ Mount correct weighing pan.
	Abort of the adjustment using the  key.	

7.4 Index

AC adapter	7	Interface	14, 22	Setting up	6
AC adapters	5	Leveling	7	Shutdown	13
Adjustment	8	Linearity	20	Stability detector	9
Adjustment weight	19	Maximum capacity	20	Standard equipment	20
Ambient conditions	19	Menu	4, 11	Standard equipment	5
Antitheft device	6	Net weight	10	Switching off	9
Calibration → Adjustment		Operation	4	Switching on	9
Cautionary notes	5	Optional equipment	22	Tare weight	10
Certified balances	3	Percent weighing	17	Taring	10
Certified balances	3	Piece counting	16	Technical data	20
Certified version	2	Power supply	7	Unstable balance environment	12
Cleaning	23	Power supply units	22	Unstable weighing samples	18
Connecting to power supply	5, 7	PowerPack	13, 22	Vibration adapter	6, 12
Connection	5, 7	Preventive maintenance	24	Vibration adapters	2
Counting	15	Printers	22, 23	Weighing	9
Degree of protection	19	Printout examples	23	Weighing mode	4
DeltaRange	4	Protective covers	22	Weighing pan	3, 20
DeltaRange balances	10	Readability	20	Weight units	19
Draft shield	21	Reference number	16		
Dynamic weighing	18, 19	Reference weight	16		
Error/error message	25	Repeatability	20		
Factory setting	12	RS232C interface	14, 22		
Fine range	10	Selecting unit 1	13		
Functions	2, 11	Service	24		
Hazard zone	5				

**To protect your METTLER TOLEDO product's future:
METTLER TOLEDO Service assures the quality, measuring accuracy and preservation of value of all
METTLER TOLEDO products for years to come.
Please send for full details about our attractive terms of service.
Thank you.**



P11780194

Subject to technical changes and to the availability
of the accessories supplied with the instruments.

© Mettler-Toledo GmbH 2003 11780194C Printed in Switzerland 0301/2.12

Mettler-Toledo GmbH, Laboratory & Weighing Technologies, CH-8606 Greifensee, Switzerland
Phone +41-1-944 22 11, Fax +41-1-944 30 60, Internet <http://www.mt.com>