

METTLER TOLEDO

# Operator Manual

**METTLER TOLEDO**

## Viper EX M and Viper EX M MB Scales

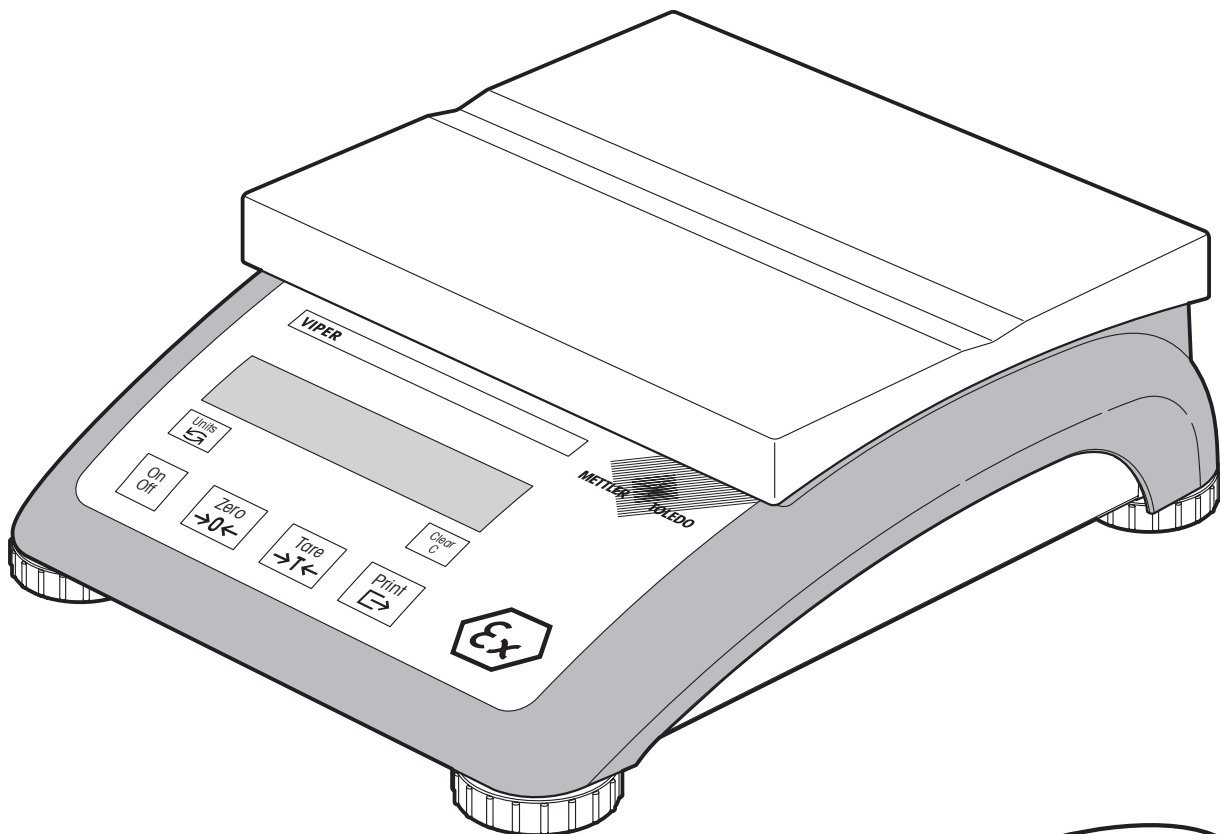

**VIPER**  
The culture of precision

# Overview of your Viper EX M / Viper EX M MB scale

## Overview

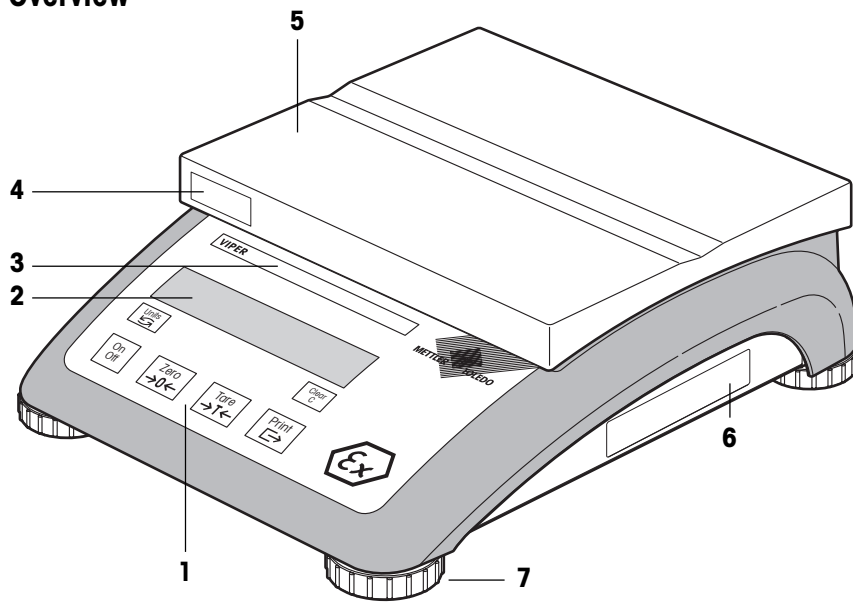

## Rear view

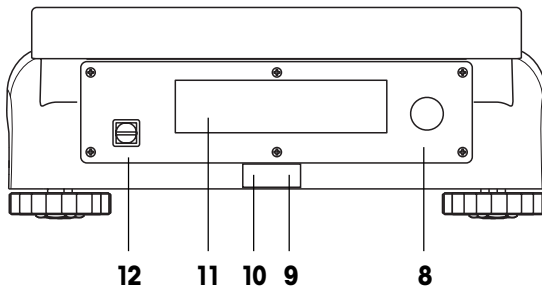

## Scale specifications

13	14
Max: 6 kg	d = 0.001 kg
Max: 12 lb	d = 0.002 lb

## Display



## Keypad

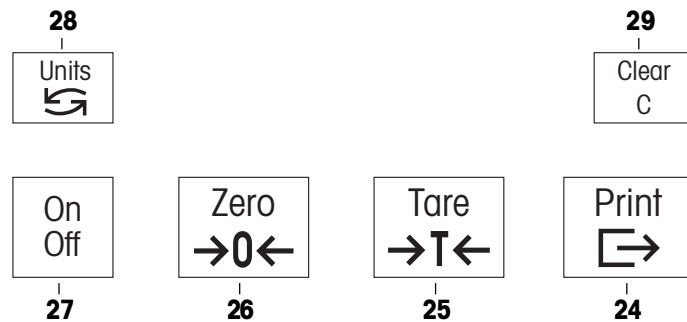

## Overview

- 1 Keypad
- 2 Display
- 3 Scale specifications (see detailed illustration)
- 4 "MonoBloc" label (if applicable)
- 5 Platter (6 lb version with small platter and draft shield)
- 6 Ex rating plate
- 7 Leveling feet

## Rear view

- 8 Opening for cable gland
  - power cable from PSUX power unit
  - power/data cable from PSU power unit
- 9 Level indicator
- 10 Hole for antitheft device (accessory)
- 11 Type plate/certification plate
- 12 Grounding screw

## Scale specifications (adhesive label)

- 13 Maximum load (in kg and lb)
- 14 Readability (display increment, in kg and lb)

## Display

- 15 Unit for piece-counting (has no function)
- 16 Weighing units
- 17 Stability detector
- 18 Information mode indicator (has no function)
- 19 Data transfer (lights up while data is transmitted or received via the interface)
- 20 Weighing range (has no function)
- 21 Net weight symbol
- 22 Internal battery charge status (has no function)
- 23 "Dynamic weighing" indicator (has no function)

## Keypad

- 24 Transmits the weighing result to a connected device (computer, printer, etc.) via the interface. If held down, calls up the setup mode, and when working in setup, functions as the "Yes" key to accept an option.
- 25 Tares the weighing container on the scale and sets the display to zero. When working in setup, this key is used as the "No" key to reject an option.
- 26 Sets the display to zero. When working in setup, this key can be used to navigate backward. Each time the key is pressed, the previous setup item is shown.
- 27 Switches the balance on and off. This key does not function while working in setup mode.
- 28 Switches between the two weighing units specified in setup.
- 29 Clears the current tare weight. When working in setup, this key can be used to jump to the end of the setup for rapid exit from the setup mode.

# Contents

<b>1</b>	<b>Setting up the scale</b> .....	<b>6</b>
1.1	Unpacking and checking the delivered items .....	6
1.2	Safety and environment .....	6
1.3	Selecting a location and leveling the scale .....	7
1.4	Connecting the power supply and grounding cable .....	8
<b>2</b>	<b>Weighing</b> .....	<b>9</b>
2.1	Switching on/off and setting to zero .....	9
2.2	Simple weighing .....	9
2.3	Weighing with tare .....	10
2.4	Taring options .....	11
2.4.1	Multiple taring .....	11
2.4.2	Automatic taring .....	11
2.4.3	Automatic tare clearance .....	11
2.5	Recording the weighing result .....	11
<b>3</b>	<b>Setup</b> .....	<b>12</b>
3.1	Calling up the setup mode and entering the password .....	12
3.2	Setup structure .....	12
3.3	Working with the setup mode .....	13
3.4	Scale settings ("SCALE" block) .....	15
3.4.1	Selecting the weighing units ("Units") .....	15
3.4.2	Settings for taring ("Tare") .....	16
3.4.3	Settings for zeroing ("Zero") .....	17
3.4.4	Adaptation to surrounding conditions ("Filter") .....	18
3.4.5	Resetting the scale settings to the factory settings ("Scale Reset") .....	18
3.5	Scale settings ("TERMINAL" block) .....	18
3.5.1	Settings for the display ("Device") .....	19
3.5.2	Settings for authorizing access to the setup mode ("Access") .....	19
3.6	Settings for the interface ("COMMUNICATION" block) .....	20
3.6.1	Selecting the communication mode ("Mode") .....	21
3.6.2	Setting the communication parameters ("Parameters") .....	22
3.6.3	Settings for the printed reports, or tickets ("Format") .....	23
3.6.4	Settings for data transfer ("Control") .....	24
3.6.5	Resetting the communication settings ("Communication Reset") .....	24
3.7	Printing out the settings ("DIAGNOSTICS" block) .....	25
3.8	Saving the settings and quitting the setup mode ("END" block) .....	26
3.9	Setup overview .....	27

---

<b>4</b>	<b>Additional important information .....</b>	<b>28</b>
4.1	SICS interface commands .....	28
4.1.1	Preconditions for communication between scale and computer .....	28
4.1.2	SICS standard commands supported by Viper .....	28
4.2	“TOLEDO Continuous” mode .....	29
4.2.1	“TOLEDO Continuous” output format .....	29
4.2.2	“TOLEDO Continuous” commands .....	30
4.3	Warning and error messages .....	30
4.4	Cleaning instructions .....	31
<b>5</b>	<b>Technical data and accessories .....</b>	<b>32</b>
5.1	Technical data .....	32
5.2	Dimensions .....	33
5.3	Interface specifications .....	34
5.4	Accessories .....	34
5.5	Standards and directives .....	34
5.5.1	Safety regulations .....	34
5.5.2	FCC Compliance .....	35
5.5.3	Canadian Radio Interference Regulations .....	35
5.6	Control Drawing Viper Ex 21204099 .....	36
5.7	Installation Drawing Viper Ex Canada 21204100 .....	37

# 1 Setting up the scale

Please read these operating instructions carefully and follow them exactly! If you find that any items are missing or incorrect, or if you have any other problems with your scale, please contact your authorized METTLER TOLEDO representative.

## 1.1 Unpacking and checking the delivered items

Remove the scale and accessories from the packaging. Check that all items have been delivered. The package should include:

- Viper scale
- Platter (and draft shield on 6 lb version)
- Operating instructions (this document)
- Labels for noting the weighing range and readability after setting
- Special accessories per packing list (if applicable)

## 1.2 Safety and environment

To ensure safe, environmentally compatible operation of your scale, please observe the following:

The scale is designed for operation in **hazardous areas Class I, Division 1, Groups A, B, C, D**. However, for this purpose the scale must be connected to a certified METTLER TOLEDO power supply unit:

- PSUx power supply unit (if not using the data interface)
- PSU power supply unit (if using the data interface)

**The installation instructions for the respective power supply unit must always be observed and followed.**

**The regulations for operating equipment in hazardous areas** must always be observed and followed.

Never undo the **fastening screws of the load plate support** under the platter!

**Never insert a rigid object under the load plate support** when the platter is removed.

Do not open the scale by undoing the **screws in the base**.

Use only the recommended **accessories and peripherals**.

**Treat the scale carefully.** It is a precision instrument. Avoid knocking the platter or placing excessively heavy loads on it.

Important if the Viper scale will be used in **food processing areas**: Those parts of the scale which may come into contact with food have a smooth surface and are easy to clean. The materials used do not shatter and contain no harmful substances.

Because of the danger of static charge, **a protective cover may only be used if it is made from anti-static material.**

When **disposing of the scale**, observe the applicable environmental regulations.

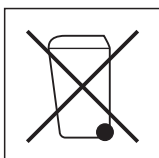

### 1.3 Selecting a location and leveling the scale

Choosing the proper location for your scale will guarantee high weighing accuracy!

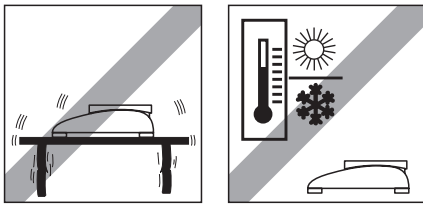

Choose a stable, vibration-free, flat surface (this is especially important for high-resolution scales and balances with METTLER TOLEDO MonoBloc technology). This surface must be able to safely bear the weight of the fully loaded scale.

Pay attention to environmental conditions.

Avoid:

- direct sunlight
- strong drafts (e.g. from fans or air conditioning)
- excessive temperature fluctuations
- the use of radio equipment in close proximity to the scale.

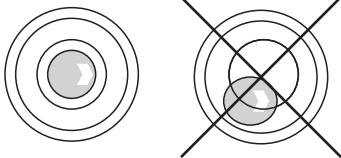
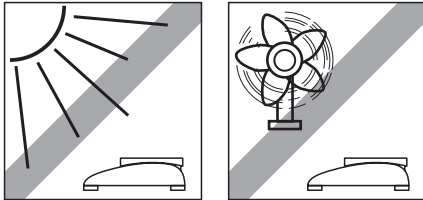

Adjust the scale horizontally by turning the leveling feet. If there is a level indicator, the air bubble must lie inside the inner circle.

#### Major changes of geographical location

Each scale is adjusted by the manufacturer for the local gravitational conditions (geo value) of the geographical zone to which the instrument is shipped. If there is a major change of geographical location, this adjustment must be corrected by a service technician, or the scale must be readjusted. Certified scales must also be recertified in accordance with applicable regulations for certification.

### 1.4 Connecting the power supply and grounding cable

To ensure protection against explosions, the scale may only be operated with either the PSUX or PSU power supply unit, and must be connected to the building ground by a cable with a cross section of 1–4 mm<sup>2</sup>.

**Important:** When making the connection, always observe and follow the separate installation instructions for the PSUX or PSU power supply unit respectively.

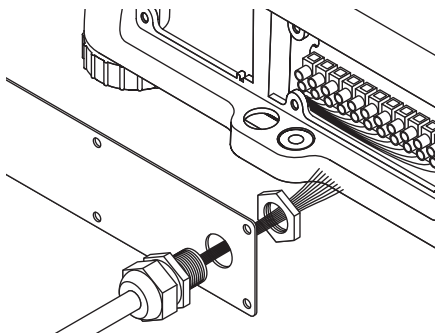

To connect the cable of the power supply unit and the grounding cable proceed as follows:

Unscrew the screws in the back plate and remove the back plate.

Fasten the screwed connector on the blue cable of the power supply unit to the back plate with the locking nut.

Connect the nine-core cable to the screw terminals of the scale according to the following table.

Scale		Power supply unit	
No.	Function	PSUX	PSU
1	U1	white	white
2	GND	yellow	yellow
3	U2	green	green
4	GND	brown	brown
5	Ubl	gray	black
6	TXD+	red	red
7	TXD-	blue	blue
8	RXD-	—	pink
9	RXD+	—	gray
10	NC	black	—
11	NC	pink	—

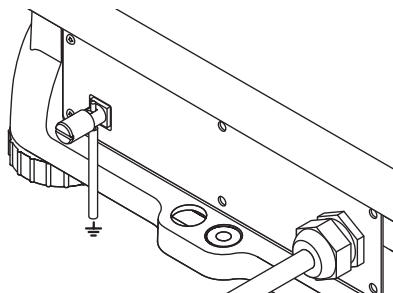

Replace the back plate and fasten it with the screws. When doing so, take care not to trap any wires.

Using a cable with a cross section of 1–4 mm<sup>2</sup> connect the grounding screw on the back of the scale to the building ground. Make sure the grounding cable is correctly connected to the scale and the building ground.

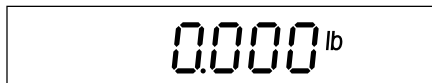

Powering up the scale initiates a display test in which all the segments and then the software version are briefly displayed. Once the decimal zero appears in the display, the scale is ready to operate.

For maximum possible precision, the scale must be adjusted/calibrated by a service technician after installing it. Note: Certified scales must be adjusted by an authorized organization. Please consult your dealer.



## 2 Weighing

This chapter explains how you switch the scale on and off, adjust the zero setting, tare the scale, carry out weighings, and record weighing results.

### 2.1 Switching on/off and setting to zero

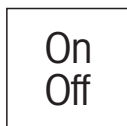

You switch the scale on and off by pressing the «**On/Off**» key.



After it has been switched on, the scale carries out a display test. When the weight display appears, the scale is ready for weighing and is automatically set to zero.

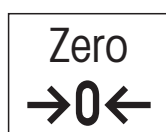

**Note:** If necessary, you can use the «**Zero**» key to set the scale to zero at any time.

### 2.2 Simple weighing

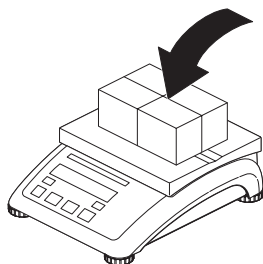

Place the weighing sample on the platter.

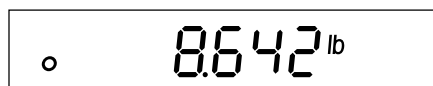

Wait until the stability detector (small ring at left-hand edge of display) goes off and then ...

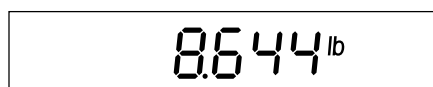

... read the weighing result.



You can use the «**Units**» key at any time to switch between the two weight units preselected in setup.

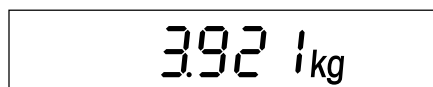

## 2.3 Weighing with tare

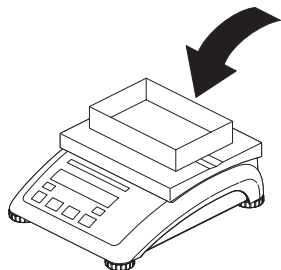

Place the **empty** weighing container or the packaging material on the platter.

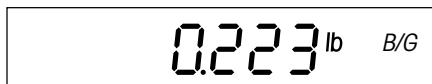

The display shows the weight of the container on the pan.



Press the «**Tare**» key to tare the scale.



The zero display and the “**NET**” (net weight) symbol appear. **Note:** If the automatic taring function has been activated in setup (Section 3.4.2), it is not necessary to press the «**Tare**» key.

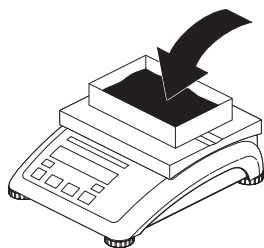

Place the weighing sample on the platter ...

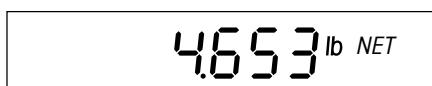

... and read the result (net weight of the weighing sample).

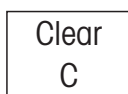

When you have completed the weighing, press the «**Clear**» key to clear the weighing result and the tare memory. The scale is now ready for the next weighing.

## 2.4 Taring options

At the factory, the scale is set so that taring is carried out using the «**Tare**» key as described in the previous section. However, other taring options can be activated in setup (Section 3.4.2); these are described below.

### 2.4.1 Multiple taring

If the “Chain tare” function is activated, you can re-tare the scale at any time by pressing the «**Tare**» key. Each time the key is pressed, the value in the tare memory is overwritten with the current weight value. This allows you to place an additional weighing container on the pan at any time and tare it. **Note:** On noncertified scales, this function is activated at the factory; on certified scales, this function is not available.

If the “Chain tare” function has been switched off in setup, only one single taring is allowed for each weighing operation. If you nevertheless attempt to tare the scale a second time, the error message “No” appears. You can only tare again after the current weighing result has been cleared with the «**Clear**» key or the display has been reset to zero using the «**Zero**» key.

### 2.4.2 Automatic taring

If the “Autotare” function is activated, the scale automatically interprets the first weight placed on the pan as the tare weight. When weighing is complete and all items have been removed from the platter, after a few seconds, the tare value is cleared and the scale is ready for the next taring and weighing. **Note:** The “Autotare” function is turned off at the factory. On noncertified scales, it can be activated in setup; on certified scales, this function is not available.

### 2.4.3 Automatic tare clearance

If this function is activated, the tare value is automatically cleared when the weighing container is removed from the platter, provided that a weighing has previously been carried out. **Note:** At the factory, automatic tare clearance is turned off. This function can only be activated in setup if the automatic taring function is turned off.

## 2.5 Recording the weighing result

```
4.876 lb G
0.223 lb T
4.653 lb NET
```

Pressing the «**Print**» key transmits the current weighing result via the interface to the peripheral device (printer, computer). At the factory the interface is configured for connection of a printer. Refer to Section 3.6 for information about configuring the interface.

The example on the left shows a record of a weighing with tare. “G” indicates the gross weight, “T” the tare, and “NET” the net weight.

## 3 Setup

You can use the setup mode to change the settings of the scale and to activate functions. This makes it possible to adapt the scale to your individual weighing needs. To prevent incorrect operation during day-to-day work, setup is reserved for the supervisor and can only be accessed with a password (Exception: Parts of the "Terminal" block can be accessed by the user, see Section 3.5.2).

### 3.1 Calling up the setup mode and entering the password

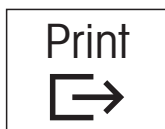

Press the «Print» key and hold it down until ...

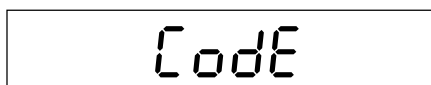

... the prompt to enter the password appears.

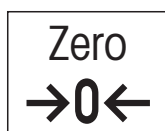

3x

The password comprises a series of keystrokes. At the factory, the password for the supervisor has been set to «Zero» «Zero» «Zero». We recommend you to replace this password with one of your own as soon as possible (Section 3.5.2).

To call up the setup mode using the password set at the factory, briefly press the «Zero» key three times.

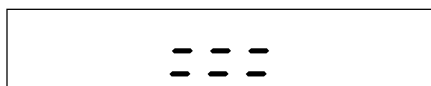

Each keystroke you enter is shown in the display as a double horizontal dash.

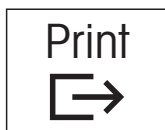

Confirm the password with the «Print» key.

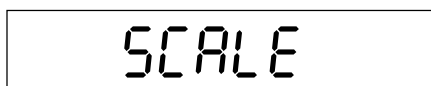

If you entered the password correctly, the first main block of the setup now appears.

**Note:**

- Enter the password as soon as you are prompted with "Code"; otherwise, the scale returns to normal operation after a few seconds.
- If the password you entered is incorrect, an error message ("no") appears, and shortly after this you will be prompted to reenter the password.
- If you do not operate any key for approximately 3 minutes, the scale automatically returns to weighing mode.

### 3.2 Setup structure

The setup of the Viper scale is divided into 5 main blocks, each of which has a number of subblocks.

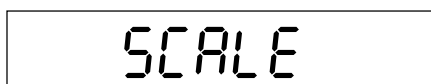

The first main block of the setup contains scale-specific settings (Section 3.4).

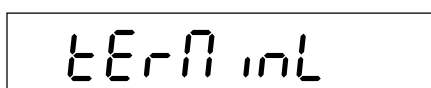

The second main block of the setup contains settings for the scale terminal and for access authorizations (Section 3.5).

In the third main block, you can specify the settings for the interface (Section 3.6).

The fourth main block can be used to print out the settings (Section 3.7).

In the fifth main block, you can save your settings and quit the setup (Section 3.8).

You will find a complete overview of the setup mode in Section 3.9.

### 3.3 Working with the setup mode

To work with the setup you use the following keys:

In the setup you use the «**Print**» key to confirm that you wish to accept a proposed option (entry to a setup block or selection of a particular setting). This key has the meaning “**YES**”.

You use the «**Tare**» key to reject a proposed option (entry to a setup block or selection of a particular setting). This key has the meaning “**NO**”.

You use the «**Zero**» key to move back through the setup. Each time you press the key it calls up the previous setup block.

The «**Clear**» key takes you directly to the end of the setup, where you can decide whether you want to save the changes before you quit the setup mode.

#### Example

In the following example you want to turn off the backlighting of the display. This setting is in the main block “Terminal” (the complete path to this setting is: Terminal → Device → Backlight → On/Off).

When you enter the setup, the first main block is displayed.

Now press the «**Tare**» (“No”) key repeatedly until the block appears in which you wish to make a setting (in this example the main block “Terminal”).

Press the «**Print**» key. By doing so, you confirm that you want to enter the selected setup block.

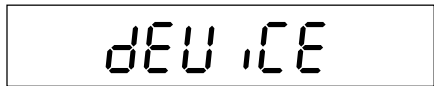

The first subblock of the "Terminal" appears.

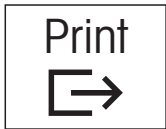

Since the setting you want to change is in this block, press the «Print» ("Yes") key.

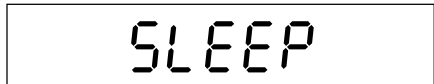

The first subblock of the "Device" block appears in the display.



Since the desired setting is not in this block, press the «Tare» ("No") key.

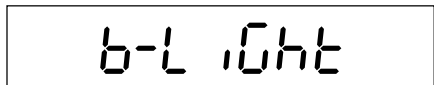

The second subblock of the "Device" setup is displayed. It is in this block that you make the setting for the backlighting.

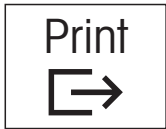

Press the «Print» key to enter this setup block.

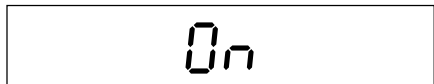

The current setting for backlighting appears in the display. At the factory, backlighting of the display is turned on ("On").



Press the «Tare» ("No") key to switch the backlighting off.

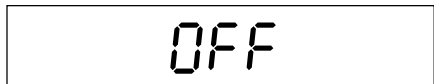

The new setting is displayed.

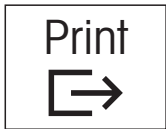

Confirm the new setting ("OFF") with the «Print» key. The backlighting is immediately turned off.

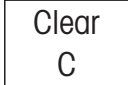

Since you do not wish to make any more settings in setup at present, now press the «Clear» key ...

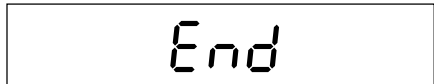

... and you arrive at the last block in the setup.

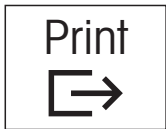

Press the «Print» ("YES") key to confirm that you wish to quit the setup mode.

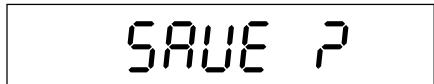

You are now asked whether you wish to save the changed setting.

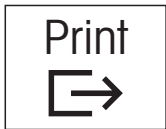

Press the «Print» ("Yes") key to save the new setting and ...

... the scale returns to weighing mode. (If you do not wish to save the changed settings, press the «Tare» ("No") key instead, and the scale continues to use the former settings).

### 3.4 Scale settings (“SCALE” block)

You use this block to make scale-specific settings. These include specifying weighing units, defining settings for taring and zeroing, as well as special filter settings to adapt the scale to its environmental conditions.

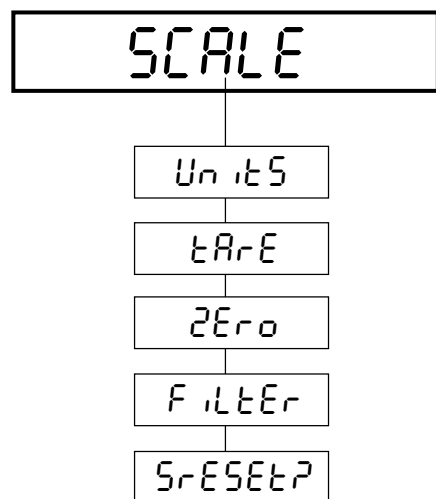

The “SCALE” main block contains the following subblocks:

Selects the weighing units (Section 3.4.1)

Defines settings for taring (Section 3.4.2)

Defines settings for zeroing (Section 3.4.3)

Adapts the scale to environmental conditions (Section 3.4.4)

Resets the settings in the “SCALE” block to the factory settings (Section 3.4.5)

#### 3.4.1 Selecting the weighing units (“Units”)

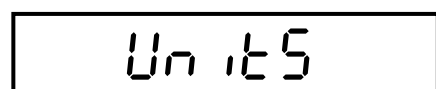

In the “Units” block, you specify the weighing units with which your Viper scale should operate. This block contains the following two subblocks:

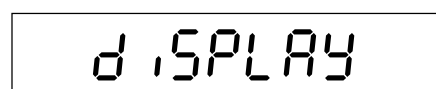

In this subblock, you specify the weighing unit which should be displayed as standard.

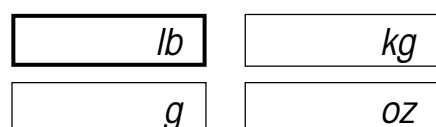

The units available are shown at left. The factory setting is “lb”.

Note: On certified scales, the settings “g” and “oz” are not available.

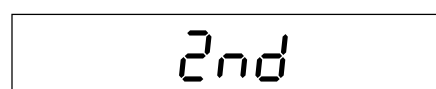

In this subblock, you specify the second weighing unit which in weighing mode will be displayed when you press the «Units» key.

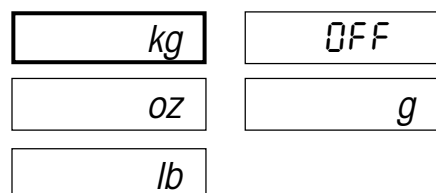

The units available are the same as the standard weighing units, but with the additional setting “OFF” (no second weighing unit). The factory setting is “kg”. On certified scales the settings “g” and “oz” are also not available as second weighing units.

### 3.4.2 Settings for taring ("Tare")

TARE

In the "Tare" block, you specify settings which control **how your scale tares**. This block contains the following four subblocks:

Pb-TARE

In this subblock ("Pushbutton Tare"), you can activate or deactivate the «Tare» key:

On

The «Tare» key is active. This is the factory setting.

OFF

The «Tare» key is inactive; if it is pressed, no taring takes place.

Chain

In this subblock, you specify whether **multiple taring** ("Chain tare") during a weighing operation is allowed. **Note: On certified scales, this block is not available!**

On

The scale can be re-tared at any time. Each time the key is pressed, the value in the tare memory is overwritten with the current weight value. This is the factory setting.

OFF

For each weighing operation, only one taring is allowed. Re-taring is only possible after the current weighing result is cleared with the «Clear» key or the display is set to zero with the «Zero» key.

A-TARE

In this subblock, you can turn the **autotare function** on or off.

OFF

The autotare function is turned off; taring is done manually using the «Tare» key. This is the factory setting.

On

The autotare function is turned on. The scale automatically interprets the first weight placed on the scale as the tare.

ACL-tr

In this subblock, you specify whether the tare should be automatically cleared ("Auto Clear Tare"). **Note: This block is not available if the autotare function is active!**

OFF

Automatic tare clearance is turned off. The current tare value is cleared with the «Clear» key or by retaring. This is the factory setting.

On

The tare value is automatically cleared when the weighing container is removed from the scale, provided that a weighing has been carried out.



### 3.4.3 Settings for zeroing (“Zero”)

Zero

In the “Zero” block, you specify the settings for zeroing the scale. This block contains the following three subblocks:

A20

In this subblock (“Autozero Mode”), you can turn **automatic zeroing** on and off and specify how it operates. The autozero function automatically corrects the zero point of the scale and thereby compensates for minor soiling of the platter. The following settings are available:

GROSS

Automatic zeroing is only active when no tare is present. This prevents small changes in weight (e.g. when dispensing small quantities into a weighing container) from being automatically compensated and the display being set to zero. This is the factory setting.

Gross-Net

Automatic zeroing is always active.

OFF

Automatic zeroing is turned off.

A-CAPt

In this subblock (“Auto Capture”), you can specify whether the scale should **automatically zero when it is turned on**, and set the allowable zeroing range. If the weight on the platter is within the selected range, the display is set to zero when the scale is switched on; otherwise, an error message appears. The following settings are available:

10%

Zeroing range at switch-on:  $\pm 10\%$  of scale capacity. This is the factory setting.

OFF

Automatic zeroing of the scale at switch-on is deactivated.

2%

Zeroing range at switch-on:  $\pm 2\%$  of scale capacity.

Pb-Zero

In this subblock (“Pushbutton Zero”, **not available on certified scales**), you can use the **«Zero» key to set zeroing on and off** and to set the allowable zero range. If the weight on the platter is within the selected range, when the **«Zero»** key is pressed the display is set to zero; otherwise, an error message appears. The following settings are possible:

10%

Zeroing range:  $\pm 10\%$  of scale capacity. This is the factory setting for noncertified scales.

20%

Zeroing range:  $+20\%/-2\%$  of scale capacity.

OFF

Zeroing with the **«Zero»** key is deactivated.

2%

Zeroing range:  $\pm 2\%$  of scale capacity.

### 3.4.4 Adaptation to surrounding conditions ("Filter")

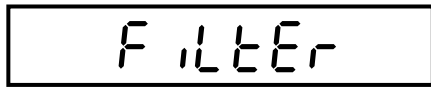

You can use the "Filter" block to adapt your scale to the surrounding conditions (vibration, drafts). This block contains no subblocks; you arrive immediately at the following settings:



Setting for **normal surrounding conditions**. This is the factory setting. The scale operates at medium speed.

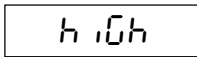

Setting for **unstable surroundings**. The scale operates more slowly than with the factory setting, but is less sensitive to external disturbance.

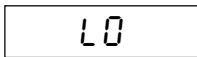

Setting for **very stable and stable surroundings**. The scale operates very fast, but is more sensitive to external disturbance.

### 3.4.5 Resetting the scale settings to the factory settings ("Scale Reset")

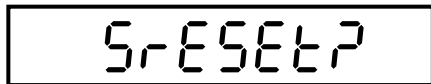

You can use the "S-Reset" ("Scale Reset") block to reset all the settings in the "SCALE" block to the factory settings.



To reset the settings, press the «Print» ("Yes") key. If you do not wish to reset the settings, press the «Tare» ("No") key instead.

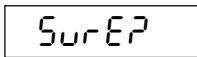

You are asked again whether you really want to reset the settings in the "SCALE" block.

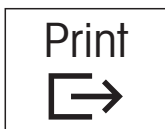

If you want to reset, press the «Print» ("Yes") key again. Otherwise, press the «Tare» ("No") key. This is your last chance to cancel the reset.

When you press the «Print» key as confirmation, all the settings in the "SCALE" block are reset and the scale immediately operates with the factory settings.

### 3.5 Scale settings ("TERMINAL" block)

In this main block, you can specify scale-specific settings. These include settings for the display, and for authorizing access to the setup mode.

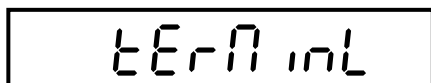

The "TERMINAL" main block contains the following subblocks:

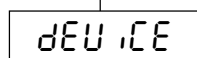

Settings for the display (Section 3.5.1)

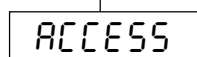

Settings for authorizing access to the setup mode (Section 3.5.2)

### 3.5.1 Settings for the display (“Device”)

DEVICE

In the “Device” block, you can specify settings for the display. This block contains the following two subblocks:

SLEEP

The setting in this subblock (“Sleep”) does not have any effect for Viper EX M and EX MB scales.

OFF

On

b-L iGht

In this subblock (“Backlight”), you can switch the **backlighting of the display** on and off:

On

Backlighting of the display is switched on. This is the factory setting.

OFF

Backlighting of the display is switched off.

### 3.5.2 Settings for authorizing access to the setup mode (“Access”)

ACCESS

In the “Access” block, you specify authorizations and passwords for the setup mode. This block contains the following two subblocks:

USER

In this subblock (“User”), you can specify whether the **operator** should have access to a part of the setup:

On

The operator has restricted access to the setup mode, specifically to the “TERMINAL” block with the settings for energy-saving mode and backlighting. This is the factory setting.

OFF

The operator has no access to the setup mode.

CODES

In this subblock (“Codes”), you can specify your own supervisor password for access to the setup mode. Proceed as follows:

Supr-Cd

Call up the “Codes” block with the «Print» (“Yes”) key and ...

EntEr

... you will be prompted to enter your new password. Enter the sequence of keystrokes you wish to use as your password. You can use up to 6 keys. **Important:** The «Print» key cannot be used in the password! Do not press this key, as it is used to terminate input and confirm the new password!

-----

Each keystroke is symbolized in the display by two double horizontal dashes. Confirm the new password by pressing the «Print» ("Yes") key.

RETYPE

You will now be prompted to enter the password again. Retype the new password and confirm it again with the «Print» ("Yes") key.

Definition of the password is now complete, and the next time you attempt to enter the setup mode you will be asked for it. **Important:** Make a note of your password! If you forget it, the service technician will have to define a new supervisor password before you can use the setup again!

### 3.6 Settings for the interface ("COMMUNICATION" block)

Your scale has a built-in current loop interface which the PSU power supply unit converts into a user-selectable interface (refer to the installation instructions for the PSU power supply unit). This main block is where you specify the settings for this interface.

COMM

The "COMMUNICATION" main block contains the following subblocks:

Mode

Selects the communication mode (Section 3.6.1)

PARAMS

Settings for the communication parameters (Section 3.6.2)

FORMAT

Settings for printed reports (Section 3.6.3)

CONTROL

Settings for data transmission (Section 3.6.4)

RESET?

Resetting "COMMUNICATION" block to the factory settings (Section 3.6.5)

### 3.6.1 Selecting the communication mode (“Mode”)

Mode

In the “Mode” block, you specify how your Viper scale should communicate through the interface. This block contains the following two subblocks:

Output

In this subblock, you specify the format in which data should be output through the interface. This depends on the device you have connected to the interface.

Print

The following settings are available:

Data output to a **printer**. This is the factory setting. **Note:** If you select this setting, a further block with settings for the report printout is also available (Section 3.6.3).

Cont-It

The **weight value** is continuously transmitted through the interface in TOLEDO format (“Continuous Weight”). This setting can be used to record weighing results on a computer. The “TOLEDO Continuous Format” is explained in Chapter 4.2.

SICS

Bidirectional communication with an external device using **MT-SICS commands**. This setting can be used to control the Viper scale from a computer. Refer to Section 4.1 for information about the SICS interface commands.

input

In this block, you can make settings for the input line of the interface.

**Important:** This subblock is only available if the setting you selected in the preceding “Output” block uses only the output line of the interface: These settings are “Print” or “Continuous Weight”. With these settings, the input line can be used separately. (This is not possible with the “SICS” setting, because this mode is bidirectional and therefore also uses the input line of the interface). You can, for example, connect a printer but still send commands from a PC to the scale through the same interface. (This requires a T-piece which allows connection of the two devices and separates the input and output lines of the interface).

The following settings are available:

HandHoff

The input line of the interface is used for the software handshake (Xon/Xoff protocol). This setting must be used if the connected device requires a software handshake. This is the factory setting.

OFF

The input line of the interface is not used.

Command

The input side of the interface is used to receive commands in TOLEDO format (see chapter 4.2.2).

### 3.6.2 Setting the communication parameters (“Parameters”)

PARAMS

In the “Parameters” block, you specify the **communication parameters** for the interface. **Important:** Make sure that these parameters are set to the same values on the external device (printer, PC) which is connected to the scale. This block contains the following three subblocks:

bAud

The “Baud” subblock is used to set the **data transmission rate of the interface**.

9600 1200  
19200 2400  
300 4800  
600

The available settings are shown at left.

The factory setting is 9600 baud.

PARITY

The “Parity” subblock is used to specify the **number of data bits** and the **parity**.

The available settings are shown below:

7 EVEN  
7 nO P  
8 nO P  
7 Odd

7 data bits, even parity. This is the factory setting.

7 data bits, no parity.

8 data bits, no parity.

7 data bits, odd parity.

CHECKSUM

In the “Checksum” subblock, you specify whether the integrity of the values transmitted through the interface should be verified by means of a **checksum**. **Important:** This subblock is only available if you have set the communication mode to “Continuous Weight” (Section 3.6.1). The following settings are available:

OFF  
On

Data validation turned off. This is the factory setting.

Data validation turned on.

### 3.6.3 Settings for the printed reports, or tickets ("Format")

FORMAT

In the "Format" block, you can specify the settings for **printing reports**.

**Important:** This block is only available if you have set the communication mode to "Print" (Section 3.6.1). This block contains the following eight subblocks:

Ln FOR

In the "Line Format" subblock, you specify how the printout should be formatted. The following settings are available:

MULTI

Multi-line printing. Each value in the report is printed on a separate line. This is the factory setting.

SINGLE

Single-line printing. Several values (e.g. net weight, tare, and gross weight) are printed on a single line.

FIELD-1

A report can contain a maximum of 6 data fields. You use subblocks "Field 1" to "Field 6" to specify which data should be printed on the report.

⋮

FIELD-6

In each of the 6 blocks "Field 1" to "Field 6" the following settings are available:

GROSS

The gross weight is printed on the report (factory setting for data field 1).

TARE

The tare weight is printed on the report (factory setting for data field 2).

NET

The net weight is printed on the report (factory setting for data field 3).

DISP

The current weight value ("Display") is printed on the report.

SPACES

Instead of the value of the data field being printed on the report, blanks ("Spaces") are inserted in its place. This setting is useful if there is a particular data field you do not wish to print out, but all the other fields should still be printed in the same positions.

NotUsed

The data field is not printed out ("Not Used", factory setting for printing fields 4 to 6). In contrast to the previous setting ("Spaces") where blanks are inserted, printing of the field is suppressed. The next field follows directly after the preceding field.

Ln-FEED

In this subblock ("Line Feed"), you can insert **additional empty lines** between the reports, for example to leave space for adding handwritten notes to the printed values.

0

You can insert from 0 to 9 empty lines. The factory setting is "0" (no additional lines are printed).

⋮

9

### 3.6.4 Settings for data transfer ("Control")

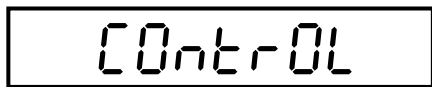

In the "Control" block you specify the conditions under which data should be transmitted through the interface. This block contains the following two subblocks:

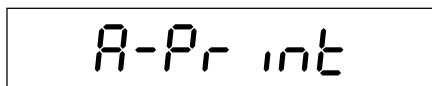

In this subblock ("Auto Print"), you specify whether the data should be transmitted automatically or by pressing a key.



Automatic data transmission is switched off. The data is only transmitted when the «Print» key is pressed. This is the factory setting.

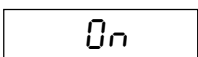

The data is automatically transmitted as soon as the weighing result is stable. Note: This function is not available with early Viper M scales.

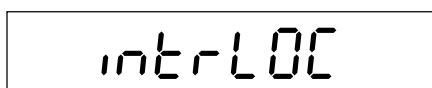

In this subblock ("Print Interlock"), you specify whether data can be transmitted only once, or several times, during a single weighing operation. The following settings can be selected:

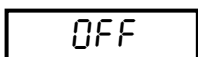

An unlimited number of data transmissions is allowed per weighing operation. Data is transmitted each time the «Print» key is pressed. This is the factory setting.

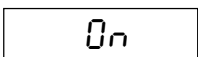

Data can only be transmitted again when the platter is completely empty or the «Clear» key has been pressed.

### 3.6.5 Resetting the communication settings ("Communication Reset")

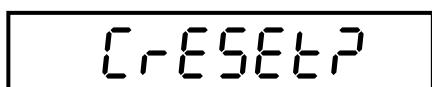

In the "C-Reset" ("Communication Reset") block, you can reset all the settings in the "COMMUNICATION" block to the factory settings.

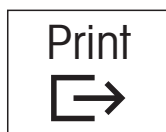

To reset the settings, press the «Print» ("Yes") key. If you do not wish to reset the settings, press «Tare» ("No") instead.

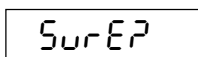

You are asked again whether you really want to reset the settings in the "COMMUNICATION" block.



If you want to reset, press the «Print» ("Yes") key again. Otherwise press the «Tare» ("No") key. This is your last chance to cancel the reset.

When you press the «Print» key as confirmation, all the settings in the "COMMUNICATION" block are reset and the scale immediately operates with the factory settings.



### 3.7 Printing out the settings (“DIAGNOSTICS” block)

In this main block you can print out your settings on a printer.

d iAGn05

The “DIAGNOSTICS” main block has only one subblock:

L 15t

Print the settings.



To print out the settings on a printer, press the «Print» key.

Shown below is an example of a printout with the factory settings.

```
Sw. ver M-1.00
SCALE
  SNR      :      99
  METrOLO  : nOnE
  buiLd
    CAP     :  6.000 lb
    rESOLu  :  0.002 lb
  GEO      :  16
  UNIT
    DiSPLAy : lb
    2nd      : kg
  tArE
    Pb-tArE : On
    ChAin   : On
    A-tArE  : OFF
    A.CL-tr : OFF
  ZErO
    AZM     : GrOSS
    A-CAPt  : 10 %
    Pb-ZErO : 10 %
  FilTEr   : MED
  tErMinL
  dEViCE
    SLEEP   : OFF
    b-LiGht : On
  ACCESS
    uSEr    : On
    SuPER   : On
```

```
COMM
  MOdE
    OutPut  : Print
    inPut   : XOn.XOFF
  PArAMS
    bAud    : 9600
    PARity  : 8 no P
    ChECSuM : OFF
  FORMat
    Ln FOR  : MuLti
    FiELd-1 : GrOSS
    FiELd-2 : tArE
    FiELd-3 : nEt
    FiELd-4 : nOt.uSEd
    FiELd-5 : nOt.uSEd
    FiELd-6 : nOt.uSEd
    Ln-FEEd : 0
  COntROL
    A-Print : OFF
    intrLOC : OFF
```

### 3.8 Saving the settings and quitting the setup mode (“END” block)

In the last main block, you can save your settings and quit the setup mode. **Note:** Whenever you press the «**Clear**» key at any point in setup, you return directly to this block.

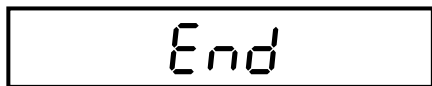

To save your settings and quit the setup mode, proceed as follows:

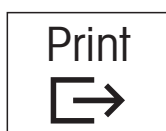

Press the «**Print**» (“Yes”) key to confirm that you want to quit the setup mode.

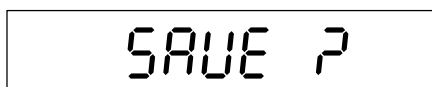

You are then asked whether you want to save the changed settings.

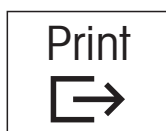

Press the «**Print**» (“Yes”) key to save the settings, or if you want to reject the changes you have made, press the «**Tare**» (“No”) key instead.



The scale then returns to weighing mode.

### 3.9 Setup overview

Shown below is an overview of the complete setup mode of your Viper EX M or EX M MB scale. The factory settings are marked with an asterisk (\*).

Level 1	Level 2	Level 3	Level 4
<b>SCALE</b>	Units	Displayed 2nd	lb*, g, kg, oz <sup>1)</sup> lb, g, kg*, oz <sup>1)</sup>
	Tare	Pushbutton	On*, Off
		Chain Tare <sup>2)</sup>	On*, Off
		Auto Tare	On, Off*
	Zero	Auto Clear Tare	On, Off*
Auto Zero Mode (AZM)		Off, Gross*, Gross/Net	
Filtering	Auto Capture	±2%, ±10%*, Off	
	Pushbutton Zero	±2%, ±10%*, +20/-2%, Off	
SCALE Reset	Low, Medium*, High		
<b>TERMINAL</b>	Device	Sure?	
		Sleep	no effect
	Access	Backlight	On*, Off
		User	On*, Off
Codes	Supervisor Code <sup>4)</sup> -> Enter code -> Retype code		
<b>COMMUNICATION</b>	Mode	Output Input <sup>5)</sup>	Print*, Cont. Weight, SICS Command, Handshake*, Off
	Parameters	Baud	300, 600, 1200, 2400, 4800, 9600*, 19200
		Bits/Parity	7/even*, 7/none, 8/none, 7/odd
		Checksum <sup>6)</sup>	On, Off*
	Format <sup>7)</sup>	Line	Multiple*, Single
		Field 1	Gross*, Tare, Net, Display, Spaces, Not Used
		Field 2	Gross, Tare*, Net, Display, Spaces, Not Used
		Field 3	Gross, Tare, Net*, Display, Spaces, Not Used
		Field 4	Gross, Tare, Net, Display, Spaces, Not Used*
		Field 5	Gross, Tare, Net, Display, Spaces, Not Used*
Control	Field 6	Gross, Tare, Net, Display, Spaces, Not Used*	
	Extra Line Feeds	0*, 1, 2, 3, 4, 5, 6, 7, 8, 9	
COMM Reset	Auto Print	On, Off*	
	Print Interlock	On, Off*	
<b>DIAGNOSTICS</b>	COM Reset	Sure?	
<b>END</b>	List		
	Save?		

1) On certified scales only "lb" and "kg" are available.

2) On certified scales this block is not available.

3) Factory setting for battery-operated scales.

4) Factory setting for the supervisor code is «Zero» «Zero» «Zero».

5) This block is not available if "SICS" has been selected in the "Output" block.

6) This block is only available if "Continuous Weight" has been set in the "Output" block.

7) This block is only available if "Print" has been set in the "Output" block.

## 4 Additional important information

In this chapter, you will find information about the interface commands, error messages, and cleaning your scale.

### 4.1 SICS interface commands

Your scale can be configured, queried, and operated from a computer via the RS232C interface of the PSU power supply unit.

#### 4.1.1 Preconditions for communication between scale and computer

For communication between the scale and a computer, the following preconditions must be fulfilled:

- The scale must be connected to the PSU power supply unit.
- The PSU power supply unit must be connected by a suitable cable to the RS232C interface of a PC (see section 5.4).
- The interface of the scale must be set to "SICS" mode (Section 3.6.1).
- The computer must have a terminal program (e.g. "Hyper Terminal") installed on it.
- The communication parameters (data transmission rate, bits, and parity) in the computer terminal program must be set to the same values as on the scale (Section 3.6.2).

#### 4.1.2 SICS standard commands supported by Viper

Your scale supports the **METTLER TOLEDO Standard Interface Command Set (MT-SICS)**. You will find detailed information about the interface commands in the **MT SICS Reference Manual** (available in English only, ME-705184). The following SICS standard commands are implemented:

Command	Response	Description
I0	I0_B_x1	Send list of implemented SICS commands
I1	I1_A_"x1"_"x2"_"x3"_"x4"_"x5"	Inquiry of SICS level and versions
I2	I2_A_"text"	Inquiry of scale data
I3	I3_A_"text"	Inquiry of scale software version and type definition
I4	I4_A_"text"	Inquiry of serial number
S	S_S_WeightValue_Unit	Send the current stable net weight value
SI	S_S_WeightValue_Unit	Send the current net weight value immediately
SIR	S_S_WeightValue_Unit	Send the net weight value repeatedly
Z	Z_A	Zero the scale
ZI	ZI_D	Zero the scale immediately
@	I4_A_"text"	Reset the scale
D_"text"	D_A	Write text into scale display
DW	DW_A	Switch main display to weight mode
D_x		see MT SICS Reference Manual
SR_PresetValue_Unit		see MT SICS Reference Manual
T	T_S_WeightValue_Unit	Tare
TA	TA_A_TareWeightValue_Unit	Inquiry of the tare weight value
TAC	TAC_A	Clear tare value
TI	TI_S_WeightValue_Unit	Tare immediately

## 4.2 "TOLEDO Continuous" mode

### 4.2.1 "TOLEDO Continuous" output format

This section contains an explanation of the structure of "TOLEDO Continuous Output Format".

Character	Status <sup>2</sup>				Field 1 <sup>3</sup>						Field 2 <sup>4</sup>						17 <sup>5</sup>	18 <sup>6</sup>
	1 <sup>1</sup>	2	3	4	5	6	7	8	9	10	11	12	13	14	15	16		
Data	S T X	S W A	S W B	S W C	M S D	—	—	—	—	L S D	M S D	—	—	—	—	L S D	C R	C H K

Table Notes: MSD Most significant digit  
LSD Least significant digit

1. STX: ASCII start of text character, hex value 02.
2. SWA, SWB, and SWC: Status Words A, B, and C. See below.
3. Field 1: In weight mode, this will be six digits of displayed weight data including leading zeroes. No decimal point in field. In count mode, this will be six digits of count (no leading zeroes) when the scale is in the count mode or six spaces if not in the count mode.
4. Field 2: In weight mode, this will be six digits of tare weight data including leading zeroes. No decimal point in field. In count mode, this will always be six zeroes.
5. CR: ASCII carriage return, hex value 0D.
6. CHK: Optional checksum character defined as the 2's compliment of the low 7 order bits of the binary sum of all characters preceding the checksum.

Status Word A Bit Definitions (N/A = not applicable)									
Function	Selection	Status Bit							
		6	5	4	3	2	1	0	
Decimal Point or Dummy Zero	X00	0	1	N/A	N/A	N/A	0	0	0
	X0						0	0	1
	X						0	1	0
	0.X						0	1	1
	0.0X						1	0	0
	0.00X						1	0	1
	0.000X						1	1	0
0.0000X			1	1	1				
Display Increment Size	X1			0	1	N/A	N/A	N/A	
	X2			1	0				
	X5			1	1				

Status Word B Bit Definitions	
Function/Value	Bit
Gross/Net: Net = 1	0
Negative = 1	1
Over Capacity = 1	2
Motion = 1	3
Lb/Kg: Kg = 1	4
1	5
Powerup = 1	6

Status Word C Bit Definitions	
Function/Value	Bit
0	0
0	1
0	2
Print Request = 1	3
Expanded Weight Mode = 1	4
1	5
Manual Tare Kg Only = 1	6

### 4.2.2 "TOLEDO Continuous" commands

In "TOLEDO Continuous" mode (selectable in the menu: *Communication – [Port 1/2] – Mode – Input – Command*), your scale supports the input commands listed below. **Important:** Each command must be terminated with Carriage Return (<CR>).

<b>P</b> <CR>	Prints out the current result (equivalent to the « <b>Print</b> » key)
<b>T</b> <CR>	Tares the scale (equivalent to the « <b>Tare</b> » key)
<b>Z</b> <CR>	Zeroes the display (equivalent to the « <b>Zero</b> » key)
<b>C</b> <CR>	Clears the current value (equivalent to the « <b>Clear</b> » or « <b>C</b> » key)
<b>Tx.xxx</b> <CR>	Specifies the tare ( $x.xxx = \text{tare weight}$ )

### 4.3 Warning and error messages

In this section you will find general error messages together with instructions for correcting their causes.

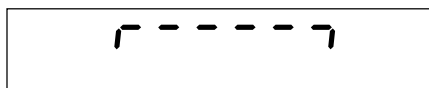

#### Overload

Reduce the load on the scale or reduce the preload.

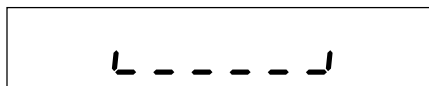

#### Underload

Place the platter on the scale and ensure it can move freely.

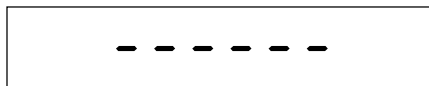

#### Result not stable

This message always appears if the scale has not yet become stable (when zeroing, taring, etc.) so it is not a true error message. If the balance still does not become stable after a long time, the "Motion" message described below appears.

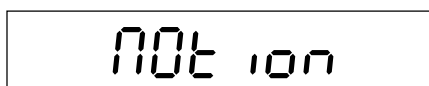

#### Stability not possible ("Motion")

While zeroing or taring, stability was not attained even after a long time.

1. Ensure that the surroundings are stable.
2. Ensure that the platter can move freely.
3. Change the filter setting (Section 3.4.4).

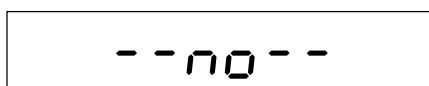

#### Function not allowed

The requested function could not be executed. This is usually because an attempt was made to execute the function at a time when it is not allowed.



#### Zeroing not possible

Make sure that zeroing is being performed in the allowed range and not with overload or underload.

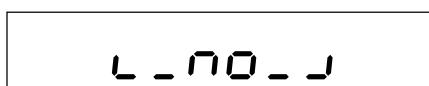

A rectangular box containing the text "Err 6" in a digital font.**Not calibrated/adjusted**

Disconnect the PSU or PSUx power supply unit from the power supply and then reconnect it. If the message appears again, have the scale calibrated/adjusted by a service technician.

A rectangular box containing the text "Err 53" in a digital font.**EAROM checksum error**

Disconnect the PSU or PSUx power supply unit from the power supply and then reconnect it. If the message reappears, contact your authorized METTLER TOLEDO representative.

## 4.4 Cleaning instructions



Before you start to clean your scale, disconnect it from the power supply!

Use a moist cloth (no acids, caustics, or strong solvents).

Do not use abrasive cleaning agents, they can scratch the display.

Do not clean the scale with a high-pressure cleaner or under running water.

If heavily soiled, remove the platter, protective cover (if present), and leveling feet, and clean them separately.

Never insert a rigid object under the load plate support when the platter is removed!

Observe all applicable regulations with regard to cleaning intervals and permitted cleaning agents.

## 5 Technical data and accessories

In this chapter you will find technical specifications for your scale, information about standards and directives, and a list of currently available accessories.

### 5.1 Technical data

Functions and settings	<p>4 weighing units (with switchover between two active units)          Filter for adaptation to environmental conditions          Automatic taring, multiple taring, automatic tare clearance          Automatic zeroing (at switch-on and during operation)          Switch-off function          Display backlighting</p>												
Display	Liquid crystal display (LCD), 20 mm high with backlighting												
Environmental conditions	<p>Performance is guaranteed in the following ranges:</p> <p>Temperature range:      14 ... 104 °F (–10 ... +40 °C) for scales with strain gauge cells                                           50 ... 86 °F (+10 ... +30 °C) for scales with MonoBloc cells</p> <p>Relative air humidity:    15 ... 85% rh (noncondensing)</p> <p>Overvoltage category:    II</p> <p>Pollution degree:        2</p>												
Explosion classification	<p>Intrinsically Safe          CL I, DIV 1, GP A, B, C, D    <math>T_{amb}</math> –10 ... +40 °C, FMRC, CSA          II 2 G EEx ib IIC T4            KEMA 00 ATEX 1116X</p>												
Power supply intrinsically safe	<p>Connect only to PSUx or PSU power supply unit!</p> <table> <tr> <td>Terminal 1:</td> <td><math>U_i</math>: 8.7 V</td> <td><math>I_i</math>: 133 mA</td> <td><math>P_i</math>: 1.15 W</td> </tr> <tr> <td>Terminal 3:</td> <td><math>U_i</math>: 12.6 V</td> <td><math>I_i</math>: 42 mA</td> <td><math>P_i</math>: 0.35 W</td> </tr> <tr> <td>Terminal 5:</td> <td><math>U_i</math>: 10.5 V</td> <td><math>I_i</math>: 74 mA</td> <td><math>P_i</math>: 0.78 W</td> </tr> </table>	Terminal 1:	$U_i$ : 8.7 V	$I_i$ : 133 mA	$P_i$ : 1.15 W	Terminal 3:	$U_i$ : 12.6 V	$I_i$ : 42 mA	$P_i$ : 0.35 W	Terminal 5:	$U_i$ : 10.5 V	$I_i$ : 74 mA	$P_i$ : 0.78 W
Terminal 1:	$U_i$ : 8.7 V	$I_i$ : 133 mA	$P_i$ : 1.15 W										
Terminal 3:	$U_i$ : 12.6 V	$I_i$ : 42 mA	$P_i$ : 0.35 W										
Terminal 5:	$U_i$ : 10.5 V	$I_i$ : 74 mA	$P_i$ : 0.78 W										
Total weight	<table> <thead> <tr> <th></th> <th>Strain gauge cell</th> <th>MonoBloc cell</th> </tr> </thead> <tbody> <tr> <td>Compact model:</td> <td>9.7 lb (4.4 kg)</td> <td>9.9 lb (4.5 kg)</td> </tr> <tr> <td>Large model:</td> <td>17.6 lb (8.0 kg)</td> <td>22.7 lb (10.3 kg)</td> </tr> </tbody> </table>		Strain gauge cell	MonoBloc cell	Compact model:	9.7 lb (4.4 kg)	9.9 lb (4.5 kg)	Large model:	17.6 lb (8.0 kg)	22.7 lb (10.3 kg)			
	Strain gauge cell	MonoBloc cell											
Compact model:	9.7 lb (4.4 kg)	9.9 lb (4.5 kg)											
Large model:	17.6 lb (8.0 kg)	22.7 lb (10.3 kg)											
Standard delivery package	Complete scale, Operating instructions												



## 5.2 Dimensions

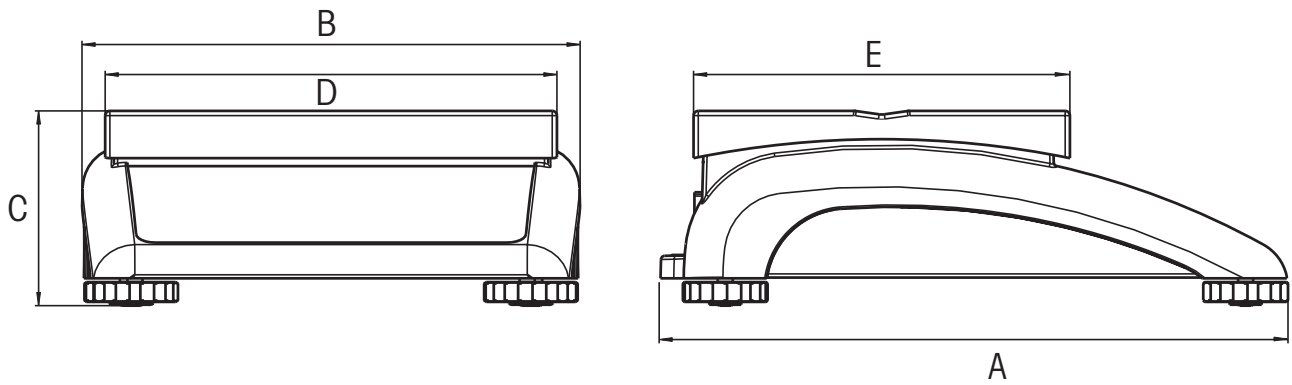

	A	B	C*	D	E
Compact model	13.19 in (335 mm)	10.43 in (265 mm)	3.94 in (100 mm)	9.45 in (240 mm)	7.87 in (200 mm)
Large model	14.56 in (370 mm)	14.17 in (360 mm)	4.53 in (115 mm)	13.78 in (350 mm)	9.45 in (240 mm)

\* with leveling feet completely screwed in

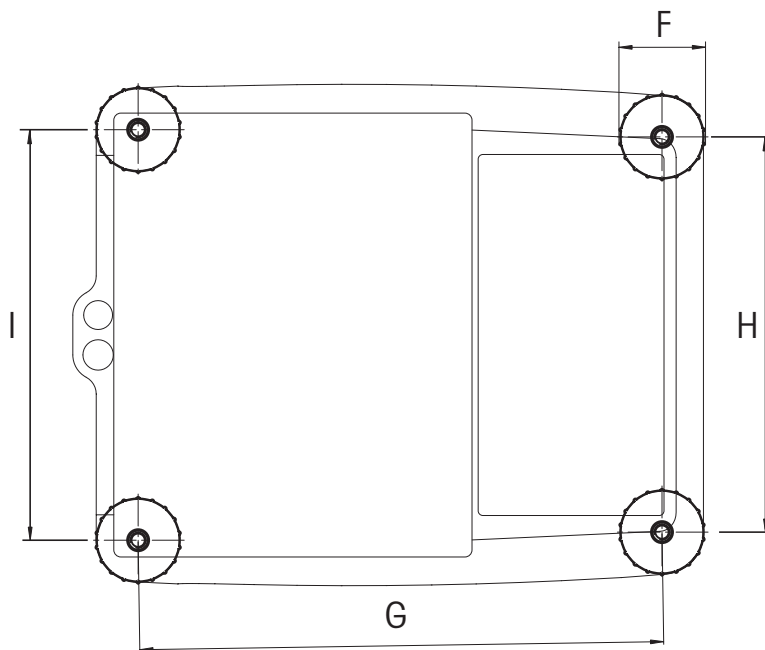

	F	G	H	I
Compact model	1.81 in (46 mm)	10.87 in (276 mm)	8.19 in (208 mm)	8.46 in (215 mm)
Large model	2.05 in (52 mm)	12.24 in (311 mm)	12.01 in (305 mm)	12.24 in (311 mm)

### 5.3 Interface specifications

The scale is equipped with a current loop interface as standard, which in the PSU power supply unit is electrically isolated and converted into a user-selectable voltage interface (e.g. according to EIA RS-232C, CCITT V24/V.28). Further details together with pin assignments will be found in the separate installation instructions for the PSU power supply unit.

### 5.4 Accessories

You can order the following accessories from your authorized METTLER TOLEDO representative:

Accessory	Art. no.
Power supply / interface unit	PSU / Viper Ex
Anti theft device with bolts	00229175
Anti theft device (steel cord with lock)	00590101

Interface cables for peripheral devices (computer, printer, etc.) see current price-list.



### 5.5 Standards and directives

Your Viper EX M or Viper EX M MB scale conforms to the standards and directives stated below.

#### 5.5.1 Safety regulations

The manufacturer of this product declares with sole responsibility that the product to which this declaration relates conforms to the following standards:

**Scale line: Viper EX M, Viper EX M MB**

Designation	Tested according to standard
	FM Standard Class No. 3600 FM Standard Class No. 3610 Intrinsically Safe Apparatus IEC/EN61326-1 Emission Kl. B (FCC, Part 15, Class A)
	C22.2 No. 0-M91 General Requirements, CEC, Part II C22.2 No. 142-M1987 Process Control Equipment C22.2 No. 157-92 Intrinsically Safe and Non-incendive Equipment IEC/EN61326-1 Emission Kl. B (CAN/CSA C108.6-91) Emission

## 5.5.2 FCC Compliance

This equipment has been tested and found to comply with the limits for a Class A digital device, pursuant to both Part 15 of the FCC Rules and the radio interference regulations of the Canadian Department of Communications. These limits are designed to provide reasonable protection against harmful interference when the equipment is operated in a commercial environment. This equipment generates, uses, and can radiate radio frequency energy and, if not installed and used in accordance with the instruction manual, may cause harmful interference to radio communications. Operation of this equipment in a residential area is likely to cause harmful interference, in which case the user will be required to correct the interference at his own expense.

## 5.5.3 Canadian Radio Interference Regulations

ICES-001 Notice for Industrial, Scientific and Medical Radio Frequency Generators:

This ISM apparatus meets all requirements of the Canadian Interference-Causing Equipment Regulations.

Please note that this requirement is only for generators which operate at over 10 000 Hz.

Avis de l'ICES-001, générateurs de radiofréquences dans le domaine industriel, scientifique et médical:

Cet appareil ISM (industriel, scientifique et médical) satisfait à toutes les exigences définies par la réglementation canadienne en matière d'équipements générant des perturbations radioélectriques.

Veillez noter qu'il s'agit d'une exigence concernant uniquement les générateurs fonctionnant au-delà de 10 000 Hz.

### 5.6 Control Drawing Viper Ex 21204099

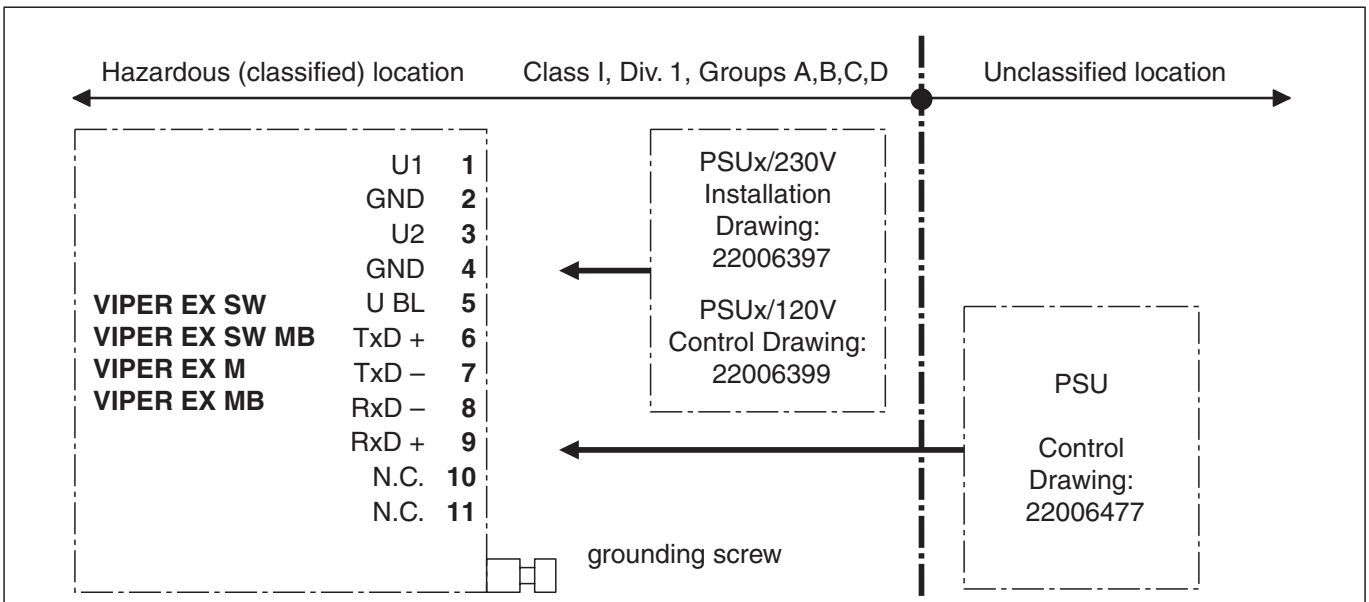

**Note: Use either PSUx or PSU**

**Viper Ex intrinsically safe input parameters**

Viper Ex	U <sub>i</sub>	I <sub>i</sub>	P <sub>i</sub>	C <sub>i</sub>	L <sub>i</sub>
pin 1 to pin 2 or 4	8.7 V	133 mA	1.15 W	111 nF	0
pin 3 to pin 2 or 4	12.6 V	42 mA	0.53 W	111 nF	0
pin 5 to pin 2 or 4	10.5 V	74 mA	0.78 W	1 nF	0
pin 6 to pin 7	15.0 V	24 mA	0.36 W	1 nF	0
pin 9 to pin 8	15.0 V	24 mA	0.36 W	1 nF	0
pin 10, pin 11	not connected				

**Notes for using the intrinsically safe scales Type Viper Ex:**

- Install the scale Type Viper Ex in a hazardous location classified Class I, Division 1, Groups A,B,C,D (or Zone 1 to European Standards).
- Temperature range: -10 °C to +40 °C.  
The useful temperature range of the scale can be restricted in regard to its weighing specifications.
- Installation shall be in accordance with national standards for hazardous locations. In the US, follow the National Electric Code ANSI/NFPA 70, and ANSI/NFPA RP12.6 "Installation of Intrinsically Safe Systems for Hazardous (Classified) Locations.
- **Warning:** substitution of components may impair intrinsic safety.
- No revisions shall be made to this drawing without prior authorization from KEMA or Factory Mutual.
- The connection to the building ground shall be made by using the grounding screw in the backplate of the scale.
- The Viper Ex must be connected to a power supply unit with approved intrinsically safe outputs and with mating safety parameters (entity concept).

<b>Control Drawing Viper Ex 21204099</b>	<b>ME-21204099</b>
Rev. 0, 14.08.2002	<b>METTLER TOLEDO</b>

## 5.7 Installation Drawing Viper Ex Canada 21204100

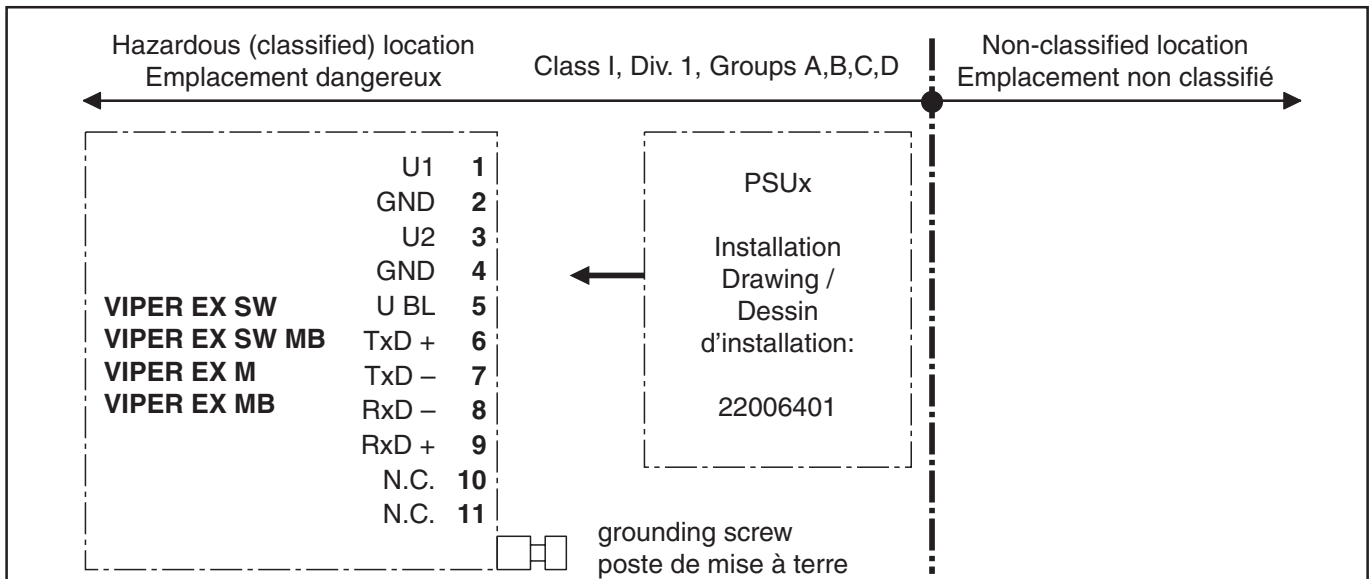

### Viper Ex intrinsically safe input parameters / valeurs de raccordement à sécurité intrinsèque

Viper Ex	U <sub>i</sub>	I <sub>i</sub>	P <sub>i</sub>	C <sub>i</sub>	L <sub>i</sub>
pin 1 to pin 2 or 4	8.7 V	133 mA	1.15 W	111 nF	0
pin 3 to pin 2 or 4	12.6 V	42 mA	0.53 W	111 nF	0
pin 5 to pin 2 or 4	10.5 V	74 mA	0.78 W	1 nF	0
pin 6 to pin 7	15.0 V	24 mA	0.36 W	1 nF	0
pin 9 to pin 8	15.0 V	24 mA	0.36 W	1 nF	0
pin 10, pin 11	not connected / pas raccordé				

#### Notes:

- Installation shall be in accordance with the Canadian Electrical Code Part 1, Appendix F. "Recommended Installation of Intrinsically Safe Systems for Hazardous (Classified) Locations".
- No revisions shall be made to this drawing without prior CSA authorization.
- **Warning:** substitution of components may impair intrinsic safety.
- Install the scale Type Viper Ex in a hazardous area Class I, Division 1, Groups A,B,C,D
- Temperature range: -10 °C to +40 °C. The useful temperature range of the scale can be restricted in regard to its weighing specifications.
- The connection to the building ground shall be made by using the grounding screw in the back plate of the scale.
- The Viper Ex must be connected to a power supply unit with CSA certified intrinsically safe outputs with mating safety parameters (entity concept).

#### Notes:

- Toute installation doit être conforme au Code Canadien d'Electricité, partie 1, annexe F, "Installation recommandée de systèmes de sécurité intrinsèque en emplacement dangereux".
- Ce dessin ne doit pas être révisé sans autorisation préalable de CSA.
- **Avertissement:** la substitution de composants peut compromettre la sécurité intrinsèque.
- La balance Viper Ex peut être installée en zone dangereuse de Classe I, Division 1, Groupes A,B,C,D
- Limites de température: -10 °C à +40 °C. Ces limites peuvent être restreintes grâce aux spécifications de fonctionnement.
- La connexion à la mise à terre du bâtiment s'effectue par le poste de mise à terre au dos du boîtier.
- La balance Viper Ex doit être raccordée à une alimentation dont les sorties sont certifiées en sécurité intrinsèque par CSA. Les valeurs de raccordement doivent correspondre aux valeurs d'entrée indiquées ci-dessus.

Installation Drawing Viper Ex Canada 21204100

ME-21204100

Rev. 0, 14.08.2002

METTLER TOLEDO





**To protect your METTLER TOLEDO product's future:  
METTLER TOLEDO service assures the quality, measuring accuracy and  
preservation of value of all METTLER TOLEDO products for years to come.  
Please send for full details about our attractive terms of service.  
Thank you.**



\*P21204001\*

Subject to technical changes and availability of the accessories  
supplied with the instruments.

Printed on 100% chlorine-free paper.  
Because we care.

© Mettler-Toledo GmbH 2002    21204001    Printed in the USA    0209/2.28

**METTLER TOLEDO**  
Scales & Systems  
1900 Polaris Parkway  
Columbus, Ohio 43240  
USA